

DESCRIPTION OF ELECTRICAL CIRCUIT MODS 128 AND 224

The general circuit arrangement consists of an R. F. stage, a combined oscillator and first detector, an I. F. stage, a combined second detector and automatic volume control and a single Pentode output stage. A Type-80 rectifier, together with a suitable filtering system, provides plate and grid voltages for all tubes and field excitation for the loudspeaker.

The signal enters the receiver through a shielded antenna lead and is applied to the grid of the R. F. tube through the antenna coupling transformer. The secondary of this transformer is tuned to the signal frequency by means of one unit of the gang-capacitor. The output of this stage is transformer coupled to the grid circuit of the first detector, which is also tuned to the signal frequency by a unit of the gang-capacitor.

Combined with the signal in the first detector is the local oscillator, which is always at a 460 K. C. frequency difference (higher) from the signal frequency. A separate coil system and the third unit of the gang-capacitor are used in this circuit.

In conjunction with these three tuned circuits, it is well to point out that three different groups of tuned circuits are used, one for each tuning band. A three-position selector switch is provided for selecting the band in which the desired signal is located. In addition to selecting the desired coil system, additional groups of contacts are provided for short-circuiting the preceding lower frequency R. F. and detector coils and the two preceding oscillator coils. This is to prevent "dead" spots due to the absorption effects caused by the coils, the natural period of which, with tuning capacitor disconnected, fall in the next higher frequency band.

The output of the first detector, which is the I. F. signal (460 K. C.), is fed directly through two tuned circuits to the grid of the I. F. amplifier stage. The I. F. stage, which utilizes Radiotron Type-6D6, uses two transformers, which consist of four tuned circuits, all of which are tuned to 460 K. C.

The output of the I. F. amplifier is then applied to the diode electrodes of the Type-6B7, which is a combined second detector, automatic volume control and A. F. amplifier. The direct current component of the rectified signal produces a voltage drop across resistor

R-12. The full voltage drop constitutes the automatic bias voltage for the R. F. while a tap is provided for the first detector and I. F. voltage. These automatic bias voltages for the R. F. first detector and I. F. give the automatic volume control action of the receiver. The volume control selects the amount of audio voltage that is applied to the grid of the Type-6B7 and thereby regulates the audio output of the entire receiver.

The output of the Type-6B7 is resistance coupled to the grid of the Type-41 tube, which is the power output amplifier. This tube is operated as a Pentode and provides high audio gain and satisfactory output power. The plate circuit of the output stage is matched to the cone coil of the reproducer by means of a step-down transformer.

The tone control consists of a variable resistor and fixed capacitor connected in series across the primary of the output transformer. At the minimum resistance position of the variable resistor, maximum attenuation of the high audio frequencies is obtained.

Plate and grid voltages for all tubes are supplied from the output of the rectifier-filter system. A Type-80 is used as a rectifier and a suitable network of capacitors and resistors gives the necessary filtering and voltages. The loudspeaker field is used as a filter reactor.

(1) LINE-UP PROCEDURE

The line-up procedure of this receiver is somewhat involved and it is important that these instructions be carefully followed when making adjustments. Properly aligned, this receiver has outstanding performance; improperly aligned, it may be impossible to receive signals on all bands.

Equipment

To properly align this receiver, proper test equipment must be used. This consists of a modulated R. F. oscillator having proper frequency range, an output indicator, an alignment tool and a tuning wand. These parts, which are shown on page 10 have been developed by the manufacturer of this receiver for use by service men to duplicate the original factory adjustments.

DATA SHEET

PRINTED IN CANADA

-COURTESY

VICTOR-206

TALKING MACHINE CO. LTD.

tor adjustments, the accuracy of the present adjustments may be checked by means of the tuning wand

The tuning wand consists of a bakelite rod having a brass cylinder at one end and a special finely divided iron insert at the other end. Inserting the cylinder into the center of a coil lowers its inductance, while inserting the iron end increases its inductance. From this, it is seen that unless the trimmer adjustment for a particular coil is perfect at alignment frequencies, inserting one end of the wand may increase the output of a particular signal. A perfect adjustment is evidenced by a lowering of output when either end of the wand is inserted into a coil.

The shields over the R. F. coil assembly have a hole at their top for entrance of the tuning wand. The location of the various coils inside of the shield is shown in Figure 8. An example of the proper manner of using the tuning wand would be to assume the external oscillator were set at 1720 and the signal tuned in, and the output indicator should be connected across the voice coil of the loudspeaker. Then the tuning wand would be inserted, first one end and then the other end, into the top of the three transformers at the left of the R. F. assembly, facing the front of the chassis. A perfect adjustment of the trimmer would be evidenced by a reduction in output when each end of the wand is inserted in each of the three transformers. If one end—for example, the iron end—when inserted in one coil caused an increase in output, then that circuit is low. An increase in the trimmer capacitance would be the proper remedy.

(2) I. F. TUNING CAPACITOR ADJUSTMENTS

Although this receiver has one I. F. stage, two transformers having four adjustable capacitors may require adjustment. The transformers are all peaked, being tuned to 460 K. C.

A detailed procedure for making this adjustment follows:

(a) Connect the output of an external oscillator tuned to 460 K. C. between the first detector grid and ground. Connect the output indicator across the voice coil of the loudspeaker.

(b) Place the oscillator in operation at 460 K. C. Place the receiver in operation and adjust the station selector until a point is reached (Band A) where no signals are heard and turn the volume control to its maximum position. Reduce the oscillator input until a slight indication is obtained in the output indicator.

...over the adjustments a second time.

This completes the I. F. adjustments. However, it is good practice to follow the I. F. adjustments with the R.F. and oscillator adjustments due to interlocking which always occurs.

(3) R. F. OSCILLATOR AND FIRST DETECTOR ADJUSTMENTS

Four R. F., oscillator and first detector adjustments are required in band "A." Three are required in bands "B" and "C."

To properly align the various bands, each band must be aligned and individually in the order given. This is "A," "B" and "C." The preliminary set-up requires the external oscillator to be connected between the antenna and ground terminals of the receiver and the output indicator must be connected across the voice coil of the loudspeaker. The volume control must be at its maximum position and the input from the oscillator must be at the minimum value possible to get an output indication under these conditions. In the high frequency bands, it may be necessary to disconnect the oscillator from the receiver and place it at a distance in order to get a sufficiently low input to the receiver.

The dial pointer must be properly set before starting any actual adjustments. This is done by turning the variable capacitor until it is at its maximum capacity position. One end of the pointer should point exactly at the horizontal line at the lowest frequency end of band "A," while the other end should point to within 1/64-inch of the horizontal line at the highest frequency end of band "A."

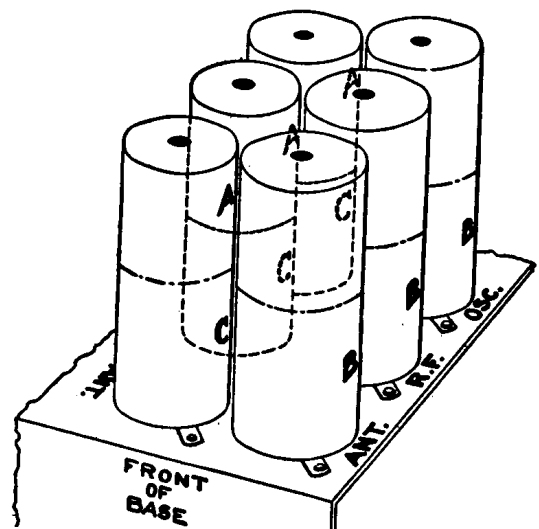

Figure 8—Location of Coils in Shields

DATA SHEET

PRINTED IN CANADA

- COURTESY

VICTOR-20c

TALKING MACHINE CO. LTD.

Band "A"

(a) Set the Band Switch at "A."

(b) The oscillator series capacitor, located on the rear apron of the chassis, should be set at about the center of its range.

(c) Tune the external oscillator to 1,720 K. C., set the pointer at 1,720 K.C. and adjust the oscillator, detector and R. F. trimmers for maximum output.

(d) Shift the external oscillator frequency to 600 K.C. Tune in the 600 K.C. signal, irrespective of scale calibration, and adjust the series trimmers, located on rear apron of chassis, for maximum output, at the same time rocking the variable tuning capacitor. Then readjust at 1,720 K. C. as described in (c).

Band "B"

(a) Set the Band Switch at "B."

(b) The detector and antenna trimmers should first be tightened to approximately $\frac{3}{4}$ maximum capacity (turned $\frac{3}{4}$ of the way in).

(c) Tune the external oscillator to 5,160 K.C., set the pointer at 5,160 K.C. Adjust the oscillator trimmer for maximum output. The trimmer should be set at the first peak obtained when increasing the trimmer capacitor from minimum to maximum.

(d) Check for the image signal which should be received at approximately 4,240 K. C. on the dial. It may be necessary to increase the external oscillator output for this check.

(e) Reduce the capacity of the detector trimmer, while rocking the tuning capacitor, until the signal disappears. The first detector circuit is then in alignment with the oscillator circuit and the Type-6A7 tube is blocked. Then increase the capacity of the detector trimmer, while rocking the tuning capacitor, until the signal is peaked for maximum output.

(f) The antenna trimmer should now be peaked for maximum output. It is not necessary to rock the main tuning capacitor while making this adjustment.

Band "C"

(a) Set the Band Switch at "C."

(b) The detector and antenna trimmers should first be tightened to approximately $\frac{3}{4}$ maximum capacity (turned $\frac{3}{4}$ of the way in).

set the pointer at 18 M. Adjust the oscillator trimmer for maximum output. The trimmer should be set at the first peak obtained when increasing the trimmer capacitor from minimum to maximum.

(d) Check for the image signal, which should be received at approximately 17,080 on the dial. It may be necessary to increase the external oscillator output for this check.

(e) Reduce the capacity of the detector trimmer, while rocking the tuning capacitor, until the signal disappears. The first detector circuit is then in alignment with the oscillator circuit and the Type-6A7 tube is blocked. Then increase the capacity of the detector trimmer, while rocking the tuning capacitor, until the signal is peaked for maximum output.

(f) The antenna trimmer should now be peaked for maximum output. It is not necessary to rock the main tuning capacitor while making this adjustment.

Output Indicator



Indicator is a neon lamp visual output indicator designed for use in conjunction with the Stock No. 9050 Test Oscillator. The indicator is very sensitive to changes of volume and frequency. It consists of a tapped transformer (giving three impedance inputs), a potentiometer and a neon lamp.

Oscillator

90 K. C. to
25,000 K. C.

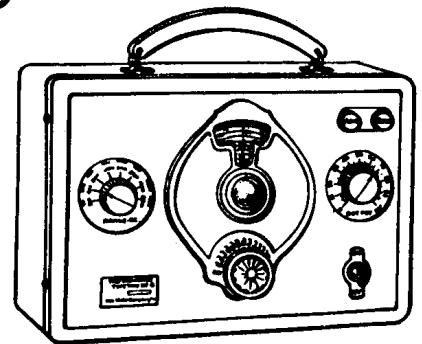

Tuning Wand

consists of a bakelite rod having a brass cylinder at one end and a special finely divided iron core at the other end. Inserting the brass cylinder into a coil lowers its inductance, while inserting the iron increases the inductance. From this it is evident that before adjusting trimmers, the adjustment may be checked by inserting each end of the wand into the coil. Proper adjustment is evidenced by a reduction in output with either end of the wand inserted into the coil. The wand is 7" long and 5/16" diameter.

DATA SHEET

— COURTESY

PRINTED IN CANADA

VICTOR-20d

TALKING MACHINE CO. LTD.

Model - 381 - 1934-35

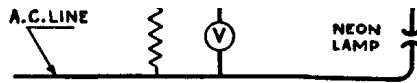
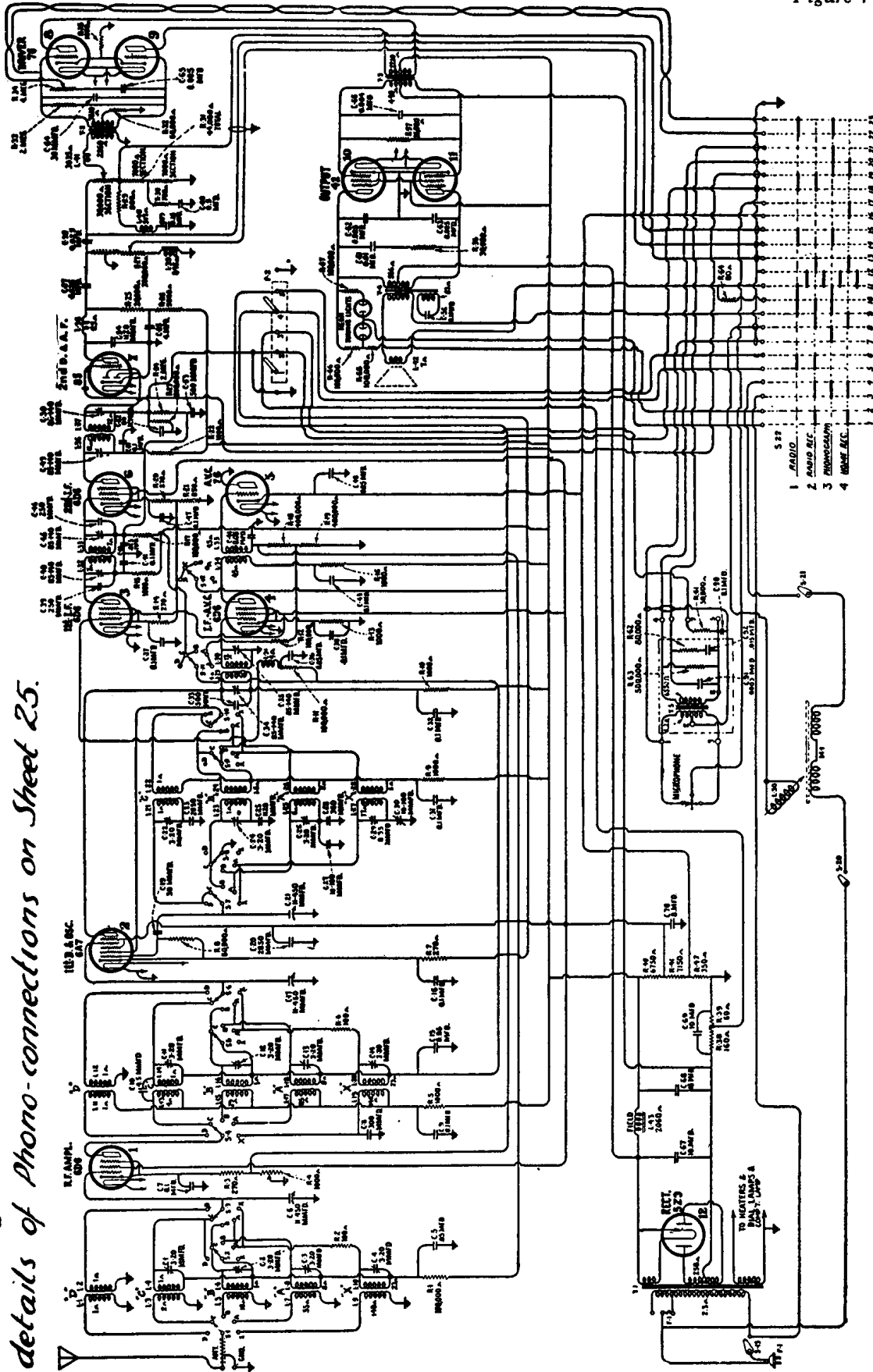

Figure 4



for voltages etc see Data Sheet 23 Model 281.
details of Phono-connections on Sheet 25.

easily checked as indicated in the circuit shown in Figure 4. The method for checking involves the use of a neon lamp. The voltage across the lamp must not be greater than 64 volts. Lamps requiring different voltages from these are defective and must not be

TESTING NEON LEVEL INDICATING LAMPS

Two Neon Level Indicating Lamps are provided so that a visual indication of the recording level may be obtained at all times. These lamps normally give long service without attention. However, if failure occurs, and all circuits have been checked and eliminated as possible source of failure, the lamps may be

DESCRIPTION OF ELECTRICAL CIRCUIT

As the chassis wiring of this instrument is similar to the Model 281 radio receiver (with the exception of those connections necessary for Phonograph and recording operation) reference to the Model 281 Service Notes will give the service man full instruction on the alignment procedure, etc., of this instrument.

DATA SHEET

PRINTED IN CANADA

- COURTESY

VICTOR-24
TALKING MACHINE CO. LTD.

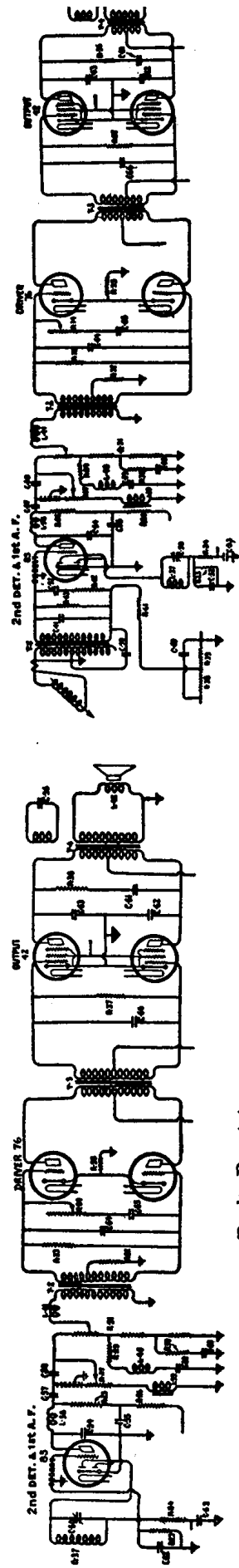
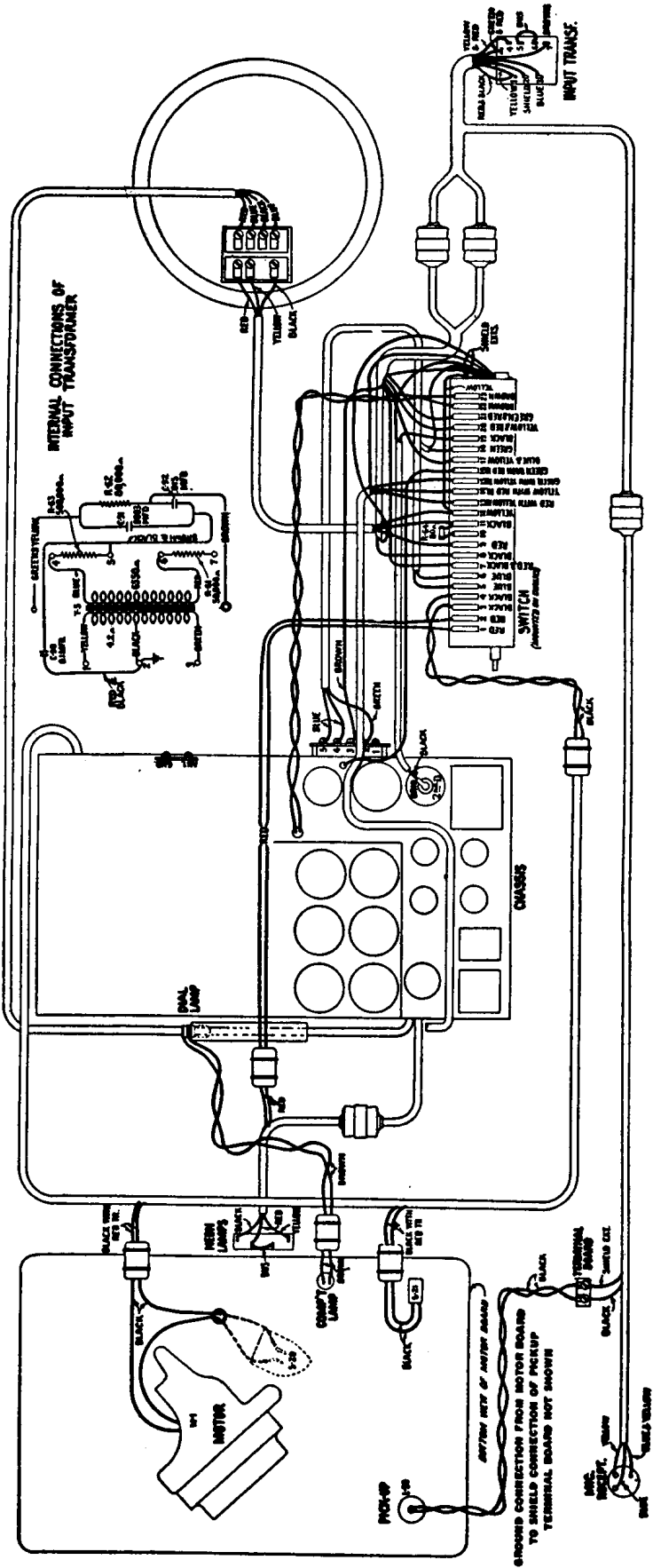

Radio Receiving

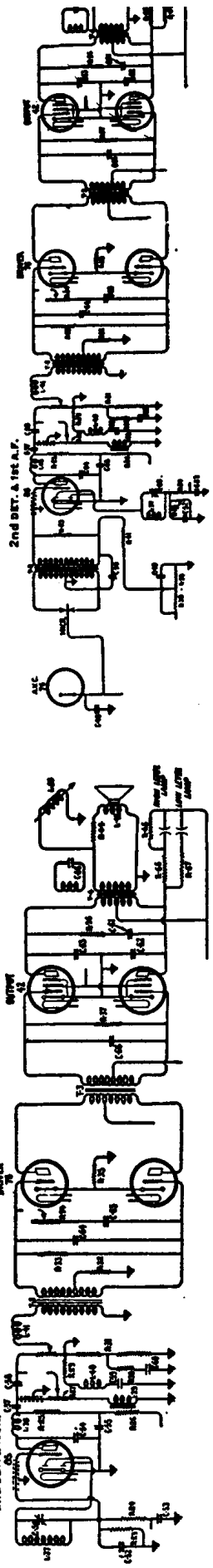

Record Reproduction

DATA SHEET

PRINTED IN CANADA

~ COURTESY ~
VICTOR-25
TALKING MACHINE CO. LTD.

Home Recording

-Schematic Circuits of Audio Amplifier at each Selector Switch Position

Radio Recording