

# ServiceManual

20-9464

## PRO-2042 PROGRAMMABLE SCANNER

Catalog Number: 20-9464

For Service Manuals Contact  
**MAURITRON TECHNICAL SERVICES**  
8 Cherry Tree Rd, Chinnor  
Oxon OX9 4QY  
Tel:- 01844-351694 Fax:- 01844-352554  
Email:- [enquiries@mauritron.co.uk](mailto:enquiries@mauritron.co.uk)

### CONTENTS

Exploded View .....	2
Mechanical Parts List .....	3
Electrical Parts List .....	4
Schematic Diagram (Linear PCB Section) .....	14
Schematic Diagram (Logic PCB Section) .....	16

# EXPLODED VIEW

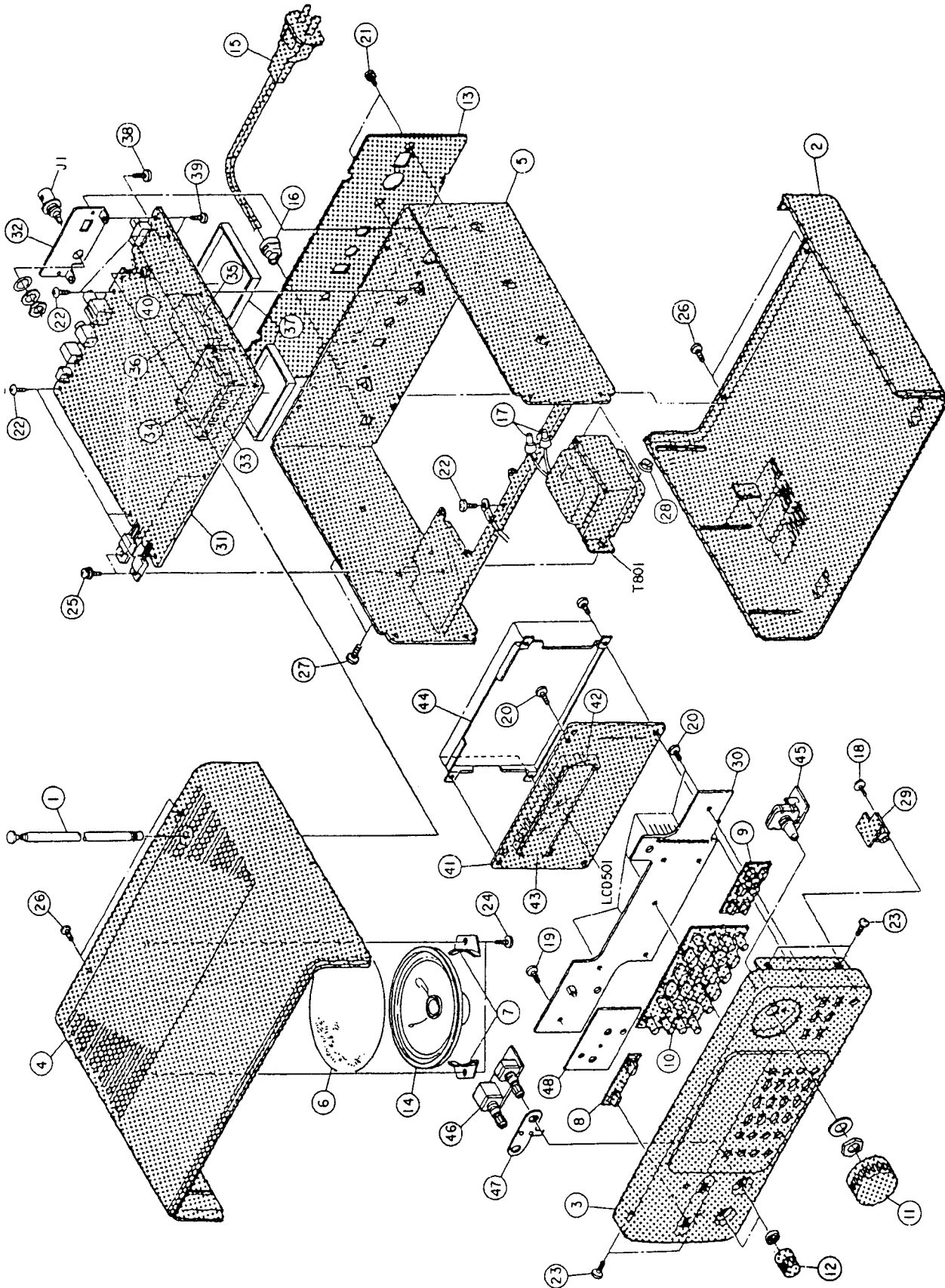

## MECHANICAL PARTS LIST

Ref. No.	Description	RS Part No.	Mfr's Part No.
1	Antenna, Telescopic		GE-88D-7597
2	Assembly, Cabinet Bottom (Non-Repairable)		GA-96D-2028
	Cabinet, Bottom		GE-95A-1668
	Cushion		GE-91D-9472
	Foot (Front)		GE-95D-1645
	Foot (Black)		SJ-5027
3	Assembly, Escutcheon Front (Non-Repairable)		GE-96D-2027
	Escutcheon, Front		GE-96C-2026
	Window, LCD		GE-95C-1375
	Tape, Adhesive		GE-93C-0691-1
4	Assembly, Cabinet Top (Non-Repairable)		GA-95D-1469
	Cabinet, Top		GE-95D-1376
	Cushion		GE-91D-9472
5	Chassis		GE-94C-1000
6	Himelon, Speaker		GE-88D-7681
7	Holder, Speaker		GE-84D-4580
8	Key Top (2 Key)		GE-95D-1382
9	Key Top (6 Key)		GE-95D-1381
10	Key Top (24 Key)		GE-95C-1380
11	Knob, Tuning		GE-95D-1379
12	Knob, Volume/Squelch		GE-95D-1378
13	Label, Rear		GE-96C-2025
14	Speaker, 8-ohm, 1W		S08J18
T801A	Transformer, Power		GE-95D-1404
	Binder, AC Cord		No. 5121 or W-140
	Binder, Wire		PLT1M-M or BK-1
15	Cord, AC		HAR CLASS II BLK 2m
16	Strain Relief, Line Cord		SR-4N-4
17	Terminal		1-SD
	Tube, AH-3		AWG6/16, 60mm/Unit
	Wire Kit		No. 9312(A)
	Hardware Kit		No. 9312(B)
18	Screw, 2x6	TP Tapping	TP 2x6
19	Screw, 2.6x5	Pan Head P Tight	P tight 2.6x5(BLK)
20	Screw, 2.6x6	Pan Head P Tight	P tight 2.6x6
21	Screw, 2.6x5	Pan Head Machine with SW	PM 2.6x5 W/SW
22	Screw, 3x8	Brazier Head Tapping	BHT 3x8
23	Screw, 3x6	Binding Head Machine (Small Type)	BM 3x6
24	Screw, 3x8	Pan Head P Tight	P tight 3x8
25	Screw, 3x8	Pan Head Machine with SW/FW	PM 3x8 W/SW/FW(Ni)
26	Screw, 3x8	Binding Head Machine	BM 3x8(Ni)
27	Screw, 4x8	Special Binding Head Machine	SBM 4x8
28	Nut,	Flange Serrated	4-DIA
48	Sheet, EDA Plastic		GE-94D-1195
29-47	See the Electrical Parts List		

**For Service Manuals Contact**  
**MAURITRON TECHNICAL SERVICES**  
 8 Cherry Tree Rd, Chinnor  
 Oxon OX9 4QY  
 Tel:- 01844-351694 Fax:- 01844-352554  
 Email:- enquires@mauritron.co.uk

# ELECTRICAL PARTS LIST

## HEADPHONE JACK PCB ASSEMBLY

Ref. No.	Description	RS Part No.	Mfr's Part No.
29	PCB Assembly, Headphone Jack Consists of the following:		GA-96D-2029
Miscellaneous			
C801 J801	Capacitor Ceramic, 0.047 $\mu$ F, 25 V, +22%–56% Jack, Headphone		DSUC70SJY5U473M HSJ0836-01-500

## KEYBOARD SWITCH PCB ASSEMBLY

Ref. No.	Description	RS Part No.	Mfr's Part No.
30	PCB Assembly, Keyboard Switch Consists of the following:		GA-94D-0993
LED			
LED601	TLR226		TLR226
Miscellaneous			
CN601	Connector, 15-Pin Male		3022-15B

## LINEAR PCB ASSEMBLY

Ref. No.	Description	RS Part No.	Mfr's Part No.
31	PCB Assembly, Linear Consists of the following:		GA-94D-0991-1
Capacitors			
C1	Ceramic 0.001 $\mu$ F 50 V $\pm$ 10% 0805		ECUX1H102KX or CM21SL102K50A
C2	Ceramic 0.001 $\mu$ F 50 V $\pm$ 10% 0603		ECUX1H102KV or CM105SL102K50A
C3	Ceramic 4 pF 50 V $\pm$ 0.25 pF 0603		ECUX1H040CV or CM105SL040C50A
C4	Ceramic 2 pF 50 V $\pm$ 0.25 pF 0603		ECUX1H020CV or CM105SL020C50A
C5	Ceramic 2 pF 50 V $\pm$ 0.25 pF 0603		ECUX1H020CV or CM105SL020C50A
C6	Ceramic 2 pF 50 V $\pm$ 0.25 pF 0603		ECUX1H020CV or CM105SL020C50A
C7	Ceramic 4 pF 50 V $\pm$ 0.25 pF 0603		ECUX1H040CV or CM105SL040C50A
C8	Ceramic 0.001 $\mu$ F 50 V $\pm$ 10% 0603		ECUX1H102KV or CM105SL102K50A
C9	Electrolytic 1 $\mu$ F 50 V $\pm$ 20%		SMB50V010M or 50UTCM010M
C10	Ceramic 0.001 $\mu$ F 50 V $\pm$ 10% 0603		ECUX1H102KV or CM105SL102K50A

Ref. No.	Description					RS Part No.	Mfr's Part No.
C234	Ceramic	22 pF	50 V	±10%	0603		ECUX1H220KV or CM105SL220K50A
C235	Ceramic	1 pF	50 V	±0.25 pF	0603		ECUX1H010CV or CM105SL010C50A
C236	Ceramic	22 pF	50 V	±10%	0603		ECUX1H220KV or CM105SL220K50A
C237	Ceramic	1 pF	50 V	±0.25 pF	0603		ECUX1H010CV or CM105SL010C50A
C238	Ceramic	100 pF	50 V	±10%	0603		ECUX1H101KV or CM105SL101K50A
C239	Ceramic	4 pF	50 V	±0.25 pF	0603		ECUX1H040CV or CM105SL040C50A
C240	Ceramic	5 pF	50 V	±0.25 pF	0603		ECUX1H050CV or CM105SL050C50A
C241	Ceramic	5 pF	50 V	±0.25 pF	0603		ECUX1H050CV or CM105SL050C50A
C242	Ceramic	220 pF	50 V	±10%	0603		ECUX1H221KV or CM105SL221K50A
C243	Ceramic	100 pF	50 V	±10%	0603		ECUX1H101KV or CM105SL101K50A
C244	Ceramic	0.001 µF	50 V	±10%	0603		ECUX1H102KV or CM105SL102K50A
C245	Ceramic	47 pF	50 V	±10%	0603		ECUX1H470KV or CM105SL470K50A
C246	Ceramic	47 pF	50 V	±10%	0603		ECUX1H470KV or CM105SL470K50A
C247	Ceramic	0.001 µF	50 V	±10%	0603		ECUX1H102KV or CM105SL102K50A
C248	Electrolytic	10 µF	16 V	±20%			SMB16V100M or 16UTCM100M
C249	Ceramic	100 pF	50 V	±10%	0603		ECUX1H101KV or CM105SL101K50A
C250	Ceramic	0.01 µF	50 V	±10%	0603		ECUX1H103KBV or CM105X7R103K50A
C251	Electrolytic	22 µF	16 V	±20%			SMB16V220M or 16UTCM220M
C252	Ceramic	100 pF	50 V	±10%	0603		ECUX1H101KV or CM105SL101K50A
C253	Ceramic	0.001 µF	50 V	±10%	0603		ECUX1H102KV or CM105SL102K50A
C254	Electrolytic	22 µF	16 V	±20%			SMB16V220M or 16UTCMS220M
C255	Ceramic	0.001 µF	50 V	±10%	0603		ECUX1H102KV or CM105SL102K50A
C256	Ceramic	0.033 µF	50 V	±10%	0805		C2012X7R1H333K or CM21X7R333K50A
C257	Ceramic	0.001 µF	50 V	±10%	0603		ECUX1H102KV or CM105SL102K50A
C258	Mylar	0.01 µF	50 V	±10%			AMZ-103K50
C259	Mylar	0.047 µF	50 V	±10%			AMZ-473K50
C260	Tantalum	0.1 µF	35 V	±10%			TSD-A-1V0R1K or ECSF1VE104
C261	Ceramic	10 pF	50 V	±0.5 pF	0603		ECUX1H100DV or CM105SL100D50A
C262	Ceramic	18 pF	50 V	±10%	0603		ECUX1H180KV or CM105SL180K50A

Ref. No.	Description					RS Part No.	Mfr's Part No.
C263	Ceramic	10 pF	50 V	±0.5 pF	0603		ECUX1H100DV or CM105SL100D50A
C264	Ceramic	6 pF	50 V	±0.5 pF	0603		ECUX1H060DV or CM105SL060D50A
C265	Ceramic	100 pF	50 V	±10%	0603		ECUX1H101KV or CM105SL101K50A
C266	Ceramic	2 pF	50 V	±0.25 pF	0603		ECUX1H020CV or CM105SL020C50A
C267	Ceramic	0.001 μF	50 V	±10%	0603		ECUX1H102KV or CM105SL102K50A
C268	Electrolytic	100 μF	16 V	±20%			SMB16V101M or 16UTCM101M
C269	Ceramic	100 pF	50 V	±10%	0603		ECUX1H101KV or CM105SL101K50A
C270	Ceramic	0.01 μF	50 V	±10%	0603		ECUX1H103KBV or CM105X7R103K50A
C271	Ceramic	0.001 μF	50 V	±10%	0603		ECUX1H102KV or CM105SL102K50A
C272	Ceramic	10 pF	50 V	±0.5 pF	0603		ECUX1H100DV or CM105SL100D50A
C273	Ceramic	10 pF	50 V	±0.5 pF	0603		ECUX1H100DV or CM105SL100D50A
C274	Electrolytic	10 μF	50 V	±20%			SM50V100M or 50UTSS100M
C275	Ceramic	0.01 μF	50 V	±10%	0603		ECUX1H103KBV or CM105X7R103K50A
C276	Ceramic	0.01 μF	50 V	±10%	0603		ECUX1H103KBV or CM105X7R103K50A
C277	Ceramic	330 pF	50 V	±10%	0603		ECUX1H331KV or CM105SL331K50A
C278	Electrolytic	10 μF	50 V	±20%			SM50V100M or 50UTSS100M
C279	Electrolytic	10 μF	16 V	±20%			SMB16V100M or 16UTCM100M
C280	Ceramic	0.01 μF	50 V	±10%	0603		ECUX1H103KBV or CM105X7R103K50A
C281	Tantalum	0.1 μF	35 V	±20%			DN1V0R1M1S
C282	Tantalum	0.33 μF	35 V	±20%			DN1VR33M1S
C283	Electrolytic	22 μF	16 V	±20%			SM16V220M or 16UTSS220M
C284	Ceramic	100 pF	50 V	±10%	0603		ECUX1H101KV or CM105SL101K50A
C285	Ceramic	0.001 μF	50 V	±10%	0603		ECUX1H102KV or CM105SL102K50A
C286	Electrolytic	10 μF	16 V	±20%			SM16V100M or 16UTSS100M
C287	Ceramic	2 pF	50 V	±0.25 pF	0603		ECUX1H020CV or CM105SL020C50A
C288	Ceramic	5 pF	50 V	±0.25 pF	0603		ECUX1H050CV or CM105SL050C50A
C289	Ceramic	0.0022 μF	50 V	±10%	0603		ECUX1H222KBV or CM105X7R222K50A
C290	Ceramic	0.01 μF	50 V	±10%	0603		ECUX1H103KBV or CM105X7R103K50A
C291	Mylar	0.1 μF	50V	±10%			AMZ-104K50
C292	Ceramic	100 pF	50 V	±10%	0603		ECUX1H101KV or CM105SL101K50A
C293   C296	Ceramic	47 pF	50 V	±10%	0603		ECUX1H470KV or CM105SL470K50A

Ref. No.	Description			RS Part No.	Mfr's Part No.
<b>Capacitor Blocks</b>					
CB1	0.01 uF x 2	250 V	+80%-20%		EXR-FS203ZS
CB2	0.01 uF x 2	250 V	+80%-20%		EXR-FS203ZS
<b>Ceramic Filters</b>					
CF1	10.7 MHz				SFE10.7MA5W-A
CF2	10.7 MHz				SFE10.7MA5W-A
CF3	455 kHz				CFU455D2 or LT455D2U
CF4	455 kHz				SFPS455H or KBF455P-6AS
<b>Diodes</b>					
D1	1SS353	Marked C	Silicon		1SS353
D2	1SS353	Marked C	Silicon		1SS353
D3	HSU277	Marked 3	Silicon		HSU277
D4	HSU277	Marked 3	Silicon		HSU277
D5	HSU277	Marked 3	Silicon		HSU277
D6	HSU277	Marked 3	Silicon		HSU277
D7	HSU277	Marked 3	Silicon		HSU277
D8	HSU277	Marked 3	Silicon		HSU277
D9	HSU277	Marked 3	Silicon		HSU277
D10	HSU277	Marked 3	Silicon		HSU277
D11	HSU277	Marked 3	Silicon		HSU277
D12	HSU277	Marked 3	Silicon		HSU277
D13	HSU277	Marked 3	Silicon		HSU277
D14	HSU277	Marked 3	Silicon		HSU277
D15	HSU277	Marked 3	Silicon		HSU277
D16	HSU277	Marked 3	Silicon		HSU277
D17	HSU277	Marked 3	Silicon		HSU277
D18	HSU277	Marked 3	Silicon		HSU277
D19	HSU277	Marked 3	Silicon		HSU277
D20	HSU277	Marked 3	Silicon		HSU277
D21	HSU277	Marked 3	Silicon		HSU277
D22	HSU277	Marked 3	Silicon		HSU277
D23	HSU277	Marked 3	Silicon		HSU277
D24	HSU277	Marked 3	Silicon		HSU277
D25	HSU277	Marked 3	Silicon		HSU277
D26	HSU277	Marked 3	Silicon		HSU277
D27	HSU277	Marked 3	Silicon		HSU277
D28	HSU277	Marked 3	Silicon		HSU277
D29	HSU277	Marked 3	Silicon		HSU277
D30	HSU277	Marked 3	Silicon		HSU277
D31	ND433G	Schottky Barrier	Silicon		ND433G
D32	HSU277	Marked 3	Silicon		HSU277
D33	HSU277	Marked 3	Silicon		HSU277
D34	MA728	Marked 2A	Silicon		MA728
D35	MA728	Marked 2A	Silicon		MA728
D36	SD103	Schottky Barrier	Silicon		SD103
D37	DA227	Marked N20	Silicon		DA227
D38	1SS354	Marked B	Silicon		1SS354
D39	DA227	Marked N20	Silicon		DA227

Ref. No.	Description	RS Part No.	Mfr's Part No.
L6	BPF 760 MHz to 1300 MHz	0805	LL2012-F5N6K
L7	BPF 280 MHz to 520 MHz	0805	LL2012-F22NK
L8	BPF 280 MHz to 520 MHz	0805	LL2012-F22NK
L9	BPF 280 MHz to 520 MHz	0805	LL2012-F22NK
L10	BPF 280 MHz to 520 MHz	0805	LL2012-F22NK
L11	BPF 280 MHz to 520 MHz	0805	LL2012-F22NK
L12	BPF 280 MHz to 520 MHz	0805	LL2012-F22NK
L13	BPF 174 MHz to 279.995 MHz	0805	LL2012-F27NK
L14	BPF 174 MHz to 279.995 MHz	0805	LL2012-F27NK
L15	BPF 174 MHz to 279.995 MHz	0805	LL2012-F47NK
L16	BPF 174 MHz to 279.995 MHz	0805	LL2012-F47NK
L17	BPF 174 MHz to 279.995 MHz	0805	LL2012-F47NK
L18	BPF 108 MHz to 173.995 MHz	0805	LL2012-F56NK
L19	BPF 108 MHz to 173.995 MHz	0805	LL2012-F56NK
L20	BPF 108 MHz to 173.995 MHz	0805	LL2012-F82NK
L21	BPF 108 MHz to 173.995 MHz	0805	LL2012-F82NK
L22	BPF 108 MHz to 173.995 MHz	0805	LL2012-F82NK
L23	BPF 68 MHz to 107.995 MHz	0805	LL2012-F82NK
L24	BPF 68 MHz to 107.995 MHz	0805	LL2012-F82NK
L25	BPF 68 MHz to 107.995 MHz	1206	LQN1AR10J04
L26	BPF 68 MHz to 107.995 MHz	1206	LQN1AR10J04
L27	BPF 68 MHz to 107.995 MHz	1206	LQN1AR10J04
L28	BPF 40 MHz to 67.995 MHz	1206	LQH1NR22K04
L29	BPF 40 MHz to 67.995 MHz	1206	LQH1NR22K04
L30	BPF 40 MHz to 67.995 MHz	1206	LQH1NR22K04
L31	BPF 40 MHz to 67.995 MHz	1206	LQH1NR22K04
L32	BPF 25 MHz to 39.995 MHz	1206	LQH1NR33K04
L33	BPF 25 MHz to 39.995 MHz	1206	LQH1NR33K04
L34	BPF 25 MHz to 39.995 MHz	1206	LQH1NR33K04
L35	BPF 25 MHz to 39.995 MHz	1206	LQH1NR33K04
L36	Choke 10 $\mu$ H		LAL03NA100M
L37	DBM		2LNM-258
L38	DBM		2LNM-258
L39	Choke		2LNO-254
L40	Choke 22 nH	0805	LL2012-F22NK
L41	Choke 22 nH	0805	LL2012-F22NK
L42	Choke 0.47 $\mu$ H		LAL03NAR47M
L43	Choke 2.2 mH		LHL06NB222J
L44	Choke 1 $\mu$ H		LAL03NA1R0M
L45	Choke		3B037
L46	Choke 220 nH	1206	LQH1NR22K04
L47	VCO		2LNO-255
L48	Stripline on PCB		
L49	Choke 27 nH	0805	LL2012-F27NK
L50	VCO		2LNO-256
L51	Filter, EMI Suppression		LC103N-1R0
L52	Choke 10 $\mu$ H		LAL03NA100M
L53	Filter, EMI Suppression		LC103N-1R0
L54	VCO		2LNB-253
L55	DC-DC Converter		GR-D835
L56	Choke 10 $\mu$ H		LAL03NA100M
L57	Choke 1 $\mu$ H		LAL03NA1R0M or AL0305-1R0K



Ref. No.	Description					RS Part No.	Mfr's Part No.
R274	Metal Glaze	3.3 kohm	1/16 W	±5%	0603		RK73K1J332J or CR10-332J
R275	Metal Glaze	10 kohm	1/16 W	±5%	0603		RK73K1J103J or CR10-103J
R276	Metal Glaze	4.7 kohm	1/16 W	±5%	0603		RK73K1J472J or CR10-472J
R277	Metal Glaze	100 ohm	1/16 W	±5%	0603		RK73K1J101J or CR10-101J
R278	Metal Glaze	470 ohm	1/16 W	±5%	0603		RK73K1J471J or CR10-471J
R279	Metal Glaze	100 kohm	1/16 W	±5%	0603		RK73K1J104J or CR10-104J
R280	Metal Glaze	470 ohm	1/16 W	±5%	0603		RK73K1J471J or CR10-471J
R281	Metal Glaze	100 ohm	1/16 W	±5%	0603		RK73K1J101J or CR10-101J
R282	Metal Glaze	100 ohm	1/16 W	±5%	0603		RK73K1J101J or CR10-101J
R283	Metal Glaze	56 ohm	1/16 W	±5%	0603		RK73K1J560J or CR10-560J
R284	Metal Glaze	100 ohm	1/16 W	±5%	0603		RK73K1J101J or CR10-101J
R285	Metal Glaze	100 ohm	1/16 W	±5%	0603		RK73K1J101J or CR10-101J
R286	Metal Glaze	33 kohm	1/16 W	±5%	0603		RK73K1J333J or CR10-333J
R287	Metal Glaze	47 kohm	1/16 W	±5%	0603		RK73K1J473J or CR10-473J
R288	Metal Glaze	6.8 kohm	1/16 W	±5%	0603		RK73K1J682J or CR10-682J
R289	Metal Glaze	2.2 kohm	1/16 W	±5%	0603		RK73K1J222J or CR10-222J
R290	Metal Glaze	1 kohm	1/16 W	±5%	0603		RK73K1J102J or CR10-102J
R291	Metal Glaze	3.3 ohm	1/16 W	±5%	0603		RK73M1J3R3J or CR10-3R3J
R292	Metal Glaze	100 kohm	1/16 W	±5%	0603		RK73K1J104J or CR10-104J
R293	Metal Glaze	100 ohm	1/16 W	±5%	0603		RK73K1J101J or CR10-101J
R294	Metal Glaze	2.2 kohm	1/16 W	±5%	0603		RK73K1J222J or CR10-222J
R295	Metal Glaze	3.3 kohm	1/16 W	±5%	0603		RK73K1J332J or CR10-332J
R296	Metal Glaze	100 ohm	1/16 W	±5%	0603		RK73K1J101J or CR10-101J
R297	Metal Glaze	100 ohm	1/16 W	±5%	0603		RK73K1J101J or CR10-101J
R298	Metal Glaze	4.7 kohm	1/16 W	±5%	0603		RK73K1J472J or CR10-472J
R299	Metal Glaze	47 ohm	1/16 W	±5%	0603		RK73K1J470J or CR10-470J
R300	Metal Glaze	1 kohm	1/16 W	±5%	0603		RK73K1J102J or CR10-102J

LOGIC PCB ASSEMBLY

Ref. No.	Description	RS Part No.	Mfr's Part No.
41	PCB Assembly, Logic Consists of the following:		GA-95D-1412E
<b>Capacitors</b>			
C501	Ceramic 0.001 $\mu$ F 50 V $\pm$ 10% 0603		ECUX1H102KV or CM105SL102K50A
C502	Ceramic 0.001 $\mu$ F 50 V $\pm$ 10% 0603		ECUX1H102KV or CM105SL102K50A
C503	Ceramic 0.001 $\mu$ F 50 V $\pm$ 10% 0603		ECUX1H102KV or CM105SL102K50A
C504	Ceramic 0.001 $\mu$ F 50 V $\pm$ 10% 0603		ECUX1H102KV or CM105SL102K50A
C505	Ceramic 0.001 $\mu$ F 50 V $\pm$ 10% 0603		ECUX1H102KV or CM105SL102K50A
C506	Ceramic 0.001 $\mu$ F 50 V $\pm$ 10% 0603		ECUX1H102KV or CM105SL102K50A
C507	Ceramic 0.001 $\mu$ F 50 V $\pm$ 10% 0603		ECUX1H102KV or CM105SL102K50A
C508	Ceramic 0.001 $\mu$ F 50 V $\pm$ 10% 0603		ECUX1H102KV or CM105SL102K50A
C509	Ceramic 0.001 $\mu$ F 50 V $\pm$ 10% 0603		ECUX1H102KV or CM105SL102K50A
C510	Ceramic 0.001 $\mu$ F 50 V $\pm$ 10% 0603		ECUX1H102KV or CM105SL102K50A
C511	Ceramic 0.001 $\mu$ F 50 V $\pm$ 10% 0603		ECUX1H102KV or CM105SL102K50A
C512	Ceramic 0.001 $\mu$ F 50 V $\pm$ 10% 0603		ECUX1H102KV or CM105SL102K50A
C513	Ceramic 0.001 $\mu$ F 50 V $\pm$ 10% 0603		ECUX1H102KV or CM105SL102K50A
C514	Ceramic 0.001 $\mu$ F 50 V $\pm$ 10% 0603		ECUX1H102KV or CM105SL102K50A
C515	Ceramic 0.001 $\mu$ F 50 V $\pm$ 10% 0603		ECUX1H102KV or CM105SL102K50A
C516	Ceramic 0.001 $\mu$ F 50 V $\pm$ 10% 0603		ECUX1H102KV or CM105SL102K50A
C517	Ceramic 0.001 $\mu$ F 50 V $\pm$ 10% 0603		ECUX1H102KV or CM105SL102K50A
C518	Ceramic 0.001 $\mu$ F 50 V $\pm$ 10% 0603		ECUX1H102KV or CM105SL102K50A
C519	Ceramic 100 pF 50 V $\pm$ 10% 0603		ECUX1H101KV or CM105SL101K50A
C520	Ceramic 100 pF 50 V $\pm$ 10% 0603		ECUX1H101KV or CM105SL101K50A
C521	Ceramic 100 pF 50 V $\pm$ 10% 0603		ECUX1H101KV or CM105SL101K50A
C522	Ceramic 100 pF 50 V $\pm$ 10% 0603		ECUX1H101KV or CM105SL101K50A
C523	Ceramic 100 pF 50 V $\pm$ 10% 0603		ECUX1H101KV or CM105SL101K50A
C524	Ceramic 100 pF 50 V $\pm$ 10% 0603		ECUX1H101KV or CM105SL101K50A
C579	Ceramic 47 pF 50 V $\pm$ 10% 0603		ECUX1H470KV or CM105SL470K50A

Ref. No.	Description					RS Part No.	Mfr's Part No.
C580	Ceramic	47 pF	50 V	±10%	0603		ECUX1H470KV or CM105SL470K50A
C581	Ceramic	0.001 µF	50 V	±10%	0603		ECUX1H102KV or CM105SL102K50A
C582	Ceramic	0.001 µF	50 V	±10%	0603		ECUX1H102KV or CM105SL102K50A
C583	Electrolytic	1 µF	50 V	±20%			SMB50V010M or 50UTCM010M
<b>Ceramic Resonator</b>							
CX501	8 MHz						EFOS8004E5
<b>Diodes</b>							
D501	1SS354	Marked B	Silicon				1SS354
D502	1MN10	Marked N10	Silicon				1MN10
D503	1MN10	Marked N10	Silicon				1MN10
D504	DA227	Marked N20	Silicon				DA227
D505	DTZ4.7CT	Marked 93	Silicon				DTZ4.7CT
<b>Integrated Circuits</b>							
IC501	GRE-9621	Microprocessor		MOS	SMT		GRE-9621
IC502	CXK5864CM-10LL or 12LL	Memory		MOS	SMT		CXK5864CM-10LL or 12LL or LC3664BML-10 or -12 or BR6265BF-N10SL
IC503	S8054HN-CB	Voltage Regulator		MOS	SMT		S8054HN-CB
<b>Coils</b>							
L501	Choke	1 µH					LQH1N1R0M04
L502	Choke	1 µH					LQH1N1R0M04
L503	Choke	1 µH					LQH1N1R0M04
L504	Choke	1 µH					LQH1N1R0M04
L505	Choke	1 µH					LQH1N1R0M04
L506	Choke	1 µH					LQH1N1R0M04
L507	Choke	1 µH					LQH1N1R0M04
L508	Filter, EMI Suppression						LC103N-1R0
L509	Choke	1 µH					LQH1N1R0M04
L510	Choke	1 µH					LQH1N1R0M04
L511	Choke	1 µH					LQH1N1R0M04
L512	Choke	1 µH					LQH1N1R0M04
L513	Choke	1 µH					LQH1N1R0M04
L514	Choke	1 µH					LQH1N1R0M04

For Service Manuals Contact  
**MAURITRON TECHNICAL SERVICES**  
8 Cherry Tree Rd, Chinnor  
Oxon OX9 4QY  
Tel:- 01844-351694 Fax:- 01844-352554  
Email:- enquiries@mauritron.co.uk

Ref. No.	Description	RS Part No.	Mfr's Part No.
<b>LEDs</b>			
LED501	LT1H51A		LT1H51A
LED502	LT1H51A		LT1H51A
LED503	LT1H51A		LT1H51A
LED504	LT1H51A		LT1H51A
LED505	LT1H51A		LT1H51A
LED506	LT1H51A		LT1H51A
LED507	LT1H51A		LT1H51A
LED508	LT1H51A		LT1H51A
LED509	LT1H51A		LT1H51A
<b>Transistors</b>			
Q501	2SA1298(Y) Marked IY	PNP	2SA1298(Y)
Q502	2SA1298(Y) Marked IY	PNP	2SA1298(Y)
Q503	2SC2712(GR) or (Y)	Marked LG or LY NPN	2SC2712(GR) or (Y)
<b>Resistors</b>			
R501	Metal Glaze 1 kohm	1/16 W ±5% 0603	RK73K1J102J or CR10-102J
R502	Metal Glaze 1 kohm	1/16 W ±5% 0603	RK73K1J102J or CR10-102J
R503	Metal Glaze 18 kohm	1/16 W ±5% 0603	RK73K1J183J or CR10-183J
R504	Metal Glaze 47 kohm	1/16 W ±5% 0603	RK73K1J473J or CR10-473J
R505	Metal Glaze 47 kohm	1/16 W ±5% 0603	RK73K1J473J or CR10-473J
R506	Metal Glaze 47 kohm	1/16 W ±5% 0603	RK73K1J473J or CR10-473J
R507	Metal Glaze 47 kohm	1/16 W ±5% 0603	RK73K1J473J or CR10-473J
R508	Metal Glaze 47 kohm	1/16 W ±5% 0603	RK73K1J473J or CR10-473J
R509	Metal Glaze 1 kohm	1/16 W ±5% 0603	RK73K1J102J or CR10-102J
R510	Metal Glaze 1 kohm	1/16 W ±5% 0603	RK73K1J102J or CR10-102J
R511	Metal Glaze 1 kohm	1/16 W ±5% 0603	RK73K1J102J or CR10-102J
R512	Metal Glaze 47 kohm	1/16 W ±5% 0603	RK73K1J473J or CR10-473J
R513	Metal Glaze 1 kohm	1/16 W ±5% 0603	RK73K1J102J or CR10-102J
R514	Metal Glaze 1 kohm	1/16 W ±5% 0603	RK73K1J102J or CR10-102J
R515	Metal Glaze 150 ohm	1/10 W ±5% 0805	RK73K2A151J or CR21-151J
R516	Metal Glaze 150 ohm	1/10 W ±5% 0805	RK73K2A151J or CR21-151J

Ref. No.	Description					RS Part No.	Mfr's Part No.
R517	Metal Glaze	150 ohm	1/10 W	±5%	0805		RK73K2A151J or CR21-151J
R518	Metal Glaze	47 kohm	1/16 W	±5%	0603		RK73K1J473J or CR10-473J
C519	Metal Glaze	3.3 kohm	1/16 W	±5%	0603		RK73K1J332J or CR10-332J
R520	Metal Glaze	47 kohm	1/16 W	±5%	0603		RK73K1J473J or CR10-473J
C521	Metal Glaze	3.3 kohm	1/16 W	±5%	0603		RK73K1J332J or CR10-332J
R522	Metal Glaze	47 kohm	1/16 W	±5%	0603		RK73K1J473J or CR10-473J
R523	Metal Glaze	1 kohm	1/16 W	±5%	0603		RK73K1J102J or CR10-102J
R524	Metal Glaze	10 kohm	1/16 W	±5%	0603		RK73K1J103J or CR10-103J
C525	Metal Glaze	3.3 kohm	1/16 W	±5%	0603		RK73K1J332J or CR10-332J
R526	Metal Glaze	100 kohm	1/16 W	±5%	0603		RK73K1J104J or CR10-104J
R527	Metal Glaze	4.7 kohm	1/16 W	±5%	0603		RK73K1J472J or CR10-472J
R528	Metal Glaze	22 kohm	1/16 W	±5%	0603		RK73K1J223J or CR10-223J
R529	Metal Glaze	82 kohm	1/16 W	±5%	0603		RK73K1J823J or CR10-823J
R530	Metal Glaze	470 kohm	1/16 W	±5%	0603		RK73K1J474J or CR10-474J
<b>Resistor Blocks</b>							
RA501	1 kohm x 4	1/16 W	±5%				CN1J4102J
RA502	1 kohm x 4	1/16 W	±5%				CN1J4102J
RA503	1 kohm x 4	1/16 W	±5%				CN1J4102J
RA504	1 kohm x 4	1/16 W	±5%				CN1J4102J
RA505	1 kohm x 4	1/16 W	±5%				CN1J4102J
RA506	1 kohm x 4	1/16 W	±5%				CN1J4102J
RA507	1 kohm x 4	1/16 W	±5%				CN1J4102J
RA508	1 kohm x 4	1/16 W	±5%				CN1J4102J
RA509	1 kohm x 4	1/16 W	±5%				CN1J4102J
RA510	1 kohm x 4	1/16 W	±5%				CN1J4102J
RA511	1 kohm x 4	1/16 W	±5%				CN1J4102J
RA512	1 kohm x 4	1/16 W	±5%				CN1J4102J
RA513	1 kohm x 4	1/16 W	±5%				CN1J4102J
RA514	1 kohm x 4	1/16 W	±5%				CN1J4102J
RA515	1 kohm x 4	1/16 W	±5%				CN1J4102J

For Service Manuals Contact  
**MAURITRON TECHNICAL SERVICES**  
8 Cherry Tree Rd, Chinnor  
Oxon OX9 4QY  
Tel: 01844-351694 Fax: 01844-352554  
Email: enquiries@mauritron.co.uk

# SCHEMATIC DIAGRAM (LIN

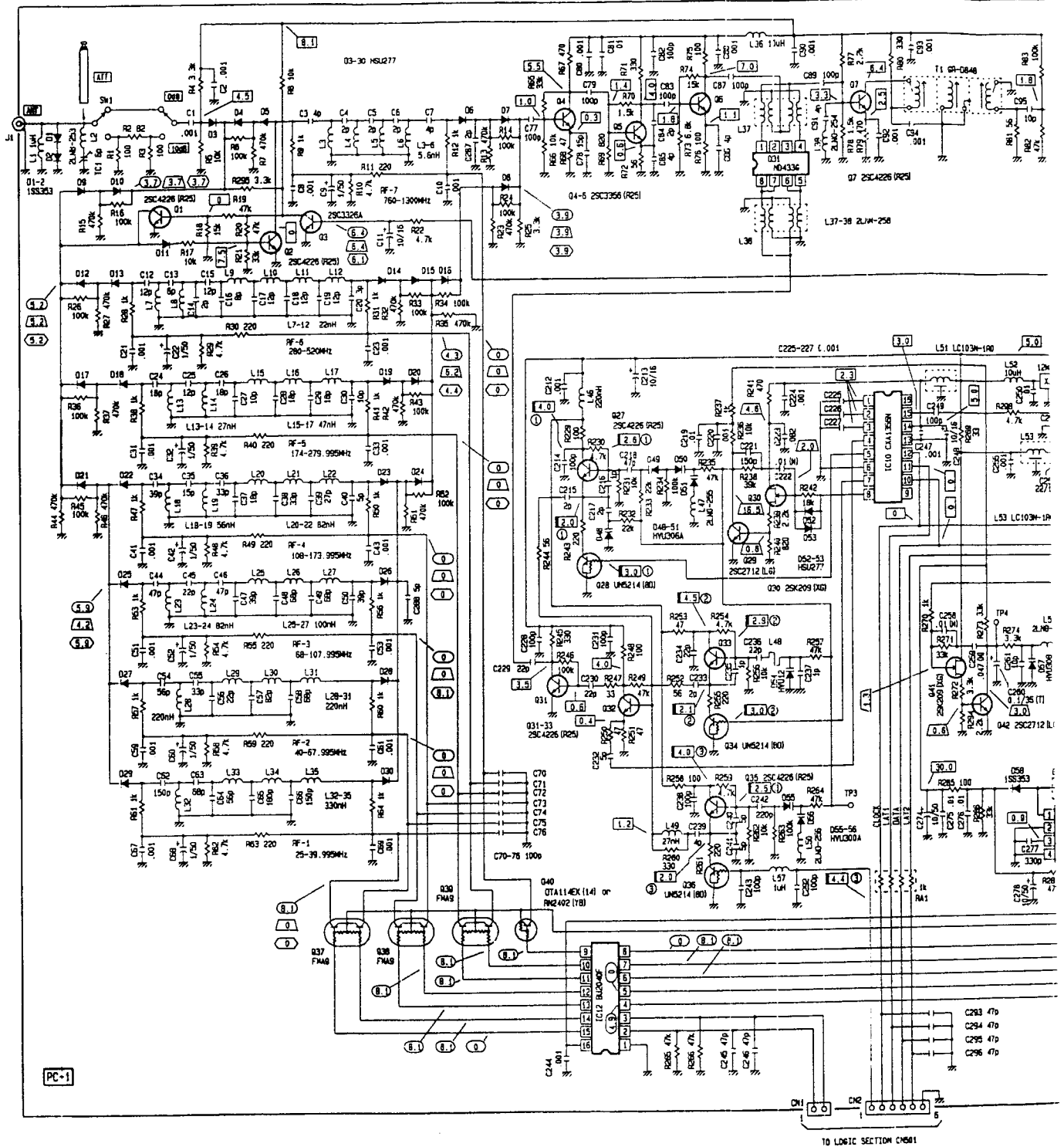

**NOTES:**

1. RESISTANCE VALUES ARE IN OHMS (K=1000 M=1000000).
2. CAPACITANCE VALUES ARE IN  $\mu$ F ( $\mu$ = $\mu$ W/F).
3. (T): TANTALUM CAPACITOR.
4. (M): MYLAR CAPACITOR.
5. NO SUFFIX: CERAMIC CAPACITOR OR CERAMIC CHIP CAPACITOR.
6. L48 IS COMPOSED OF THE PRINTED COIL CIRCUIT ON PCB.
7.  $\text{O}$  THIS SYMBOL DENOTES THE DC VOLTAGE FOR AM MODE OPERATION (25MHZ).
8.  $\text{O}$  THIS SYMBOL DENOTES THE DC VOLTAGE FOR NFM MODE OPERATION (450MHZ).
9.  $\text{O}$  THIS SYMBOL DENOTES THE DC VOLTAGE FOR FOR WFM MODE OPERATION (98MHZ).
10.  $\text{O}$  THIS SYMBOL DENOTES THE DC VOLTAGE FOR ANY MODE OPERATION.

11.  $\text{O}$  THIS SYMBOL DENOTES THE DC VOLTAGE FOR ANY MODE, AND ANY FREQUENCY BETWEEN 25 AND 520MHZ.
12.  $\text{O}$  THIS SYMBOL DENOTES THE DC VOLTAGE FOR ANY MODE, AND ANY FREQUENCY BETWEEN 750 AND 1000MHZ.
13.  $\text{O}$  THIS SYMBOL DENOTES THE DC VOLTAGE FOR ANY MODE, AND ANY FREQUENCY BETWEEN 1000.005 AND 1300MHZ.
14. THE VOLTAGES ITEMS 7 THROUGH 9 ABOVE ARE MEASURED WITH THE SQUELCH CONTROL BEING SET FULLY CCW AND THE VOLUME CONTROL SET TO ITS MINIMUM.

CAUTION: SINCE THE COMPONENTS IDENTIFIED BY  $\Delta$  ARE CRITICAL FOR SAFETY, READ THE PRODUCT SAFETY NOTICE ON PAGE 3 CAREFULLY BEFORE REPLACING ANY OF THESE COMPONENTS.

# SCHEMATIC DIAGRAM (LINEAR PCB SECTION)

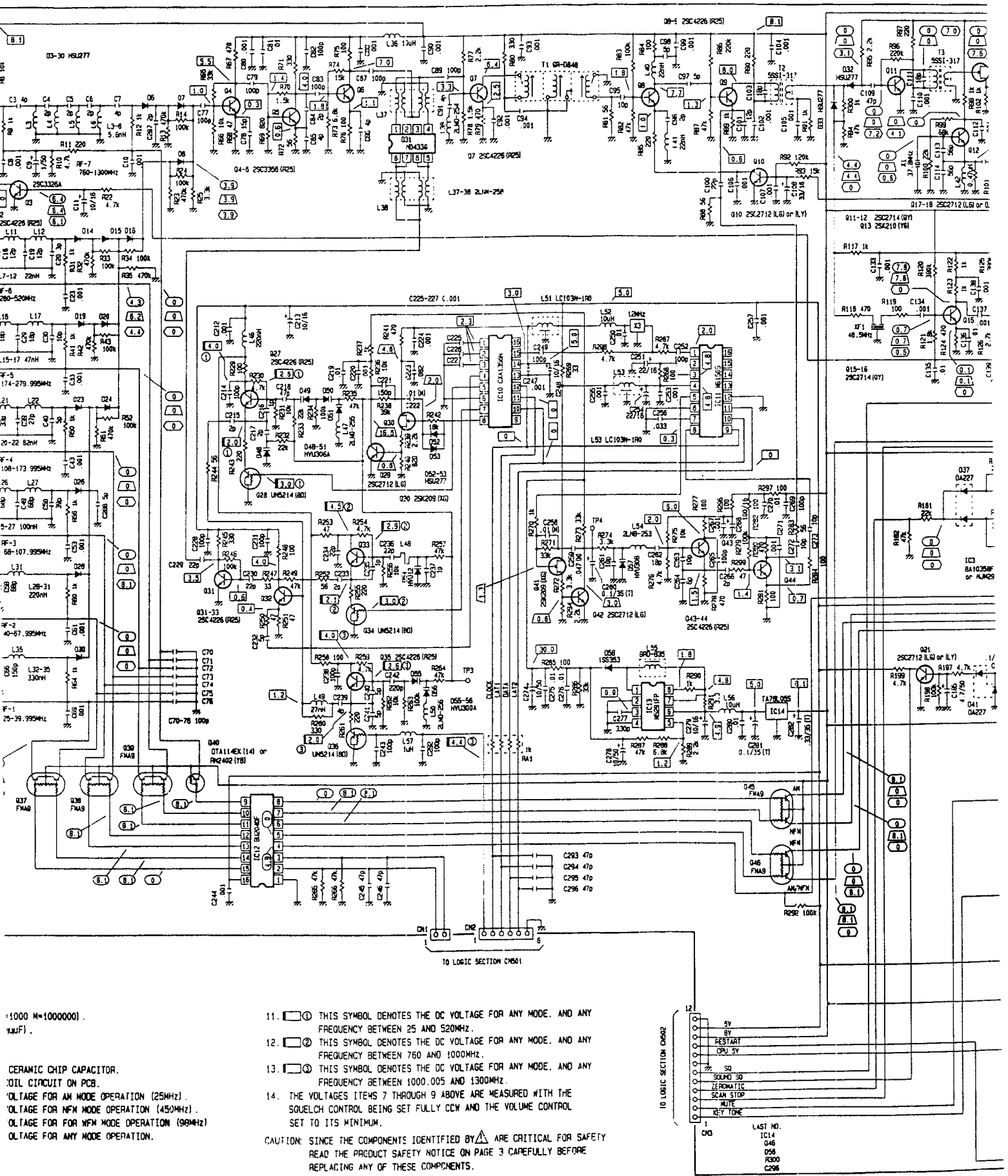

=1000 M=1000000.  
 μM(F).

CERAMIC CHIP CAPACITOR.  
 COIL CIRCUIT ON PCB.  
 \*VOLTAGE FOR AM MODE OPERATION (250kHz).  
 \*VOLTAGE FOR NFM MODE OPERATION (450kHz).  
 \*VOLTAGE FOR FOR NFM MODE OPERATION (90kHz).  
 \*VOLTAGE FOR ANY MODE OPERATION.

11. THIS SYMBOL DENOTES THE DC VOLTAGE FOR ANY MODE. AND ANY FREQUENCY BETWEEN 25 AND 520KHZ.
  12. THIS SYMBOL DENOTES THE DC VOLTAGE FOR ANY MODE. AND ANY FREQUENCY BETWEEN 760 AND 1000KHZ.
  13. THIS SYMBOL DENOTES THE DC VOLTAGE FOR ANY MODE. AND ANY FREQUENCY BETWEEN 1000.005 AND 1300KHZ.
  14. THE VOLTAGES ITEMS 7 THROUGH 9 ABOVE ARE MEASURED WITH THE SQUELCH CONTROL BEING SET FULLY CCM AND THE VOLUME CONTROL SET TO ITS MINIMUM.
- CAUTION: SINCE THE COMPONENTS IDENTIFIED BY ARE CRITICAL FOR SAFETY. READ THE PRODUCT SAFETY NOTICE ON PAGE 3 CAREFULLY BEFORE REPLACING ANY OF THESE COMPONENTS.

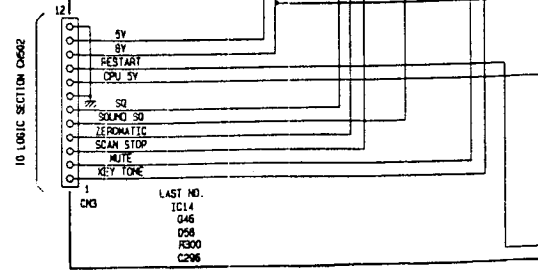

For Service Manuals Contact  
**MAURITRON TECHNICAL SERVICES**  
 8 Cherry Tree Rd, Chinnor  
 Oxon OX9 4QY  
 Tel: 01844-351694 Fax: 01844-352554  
 Email: enquiries@mauritron.co.uk

# DIAGRAM (LINEAR PCB SECTION)

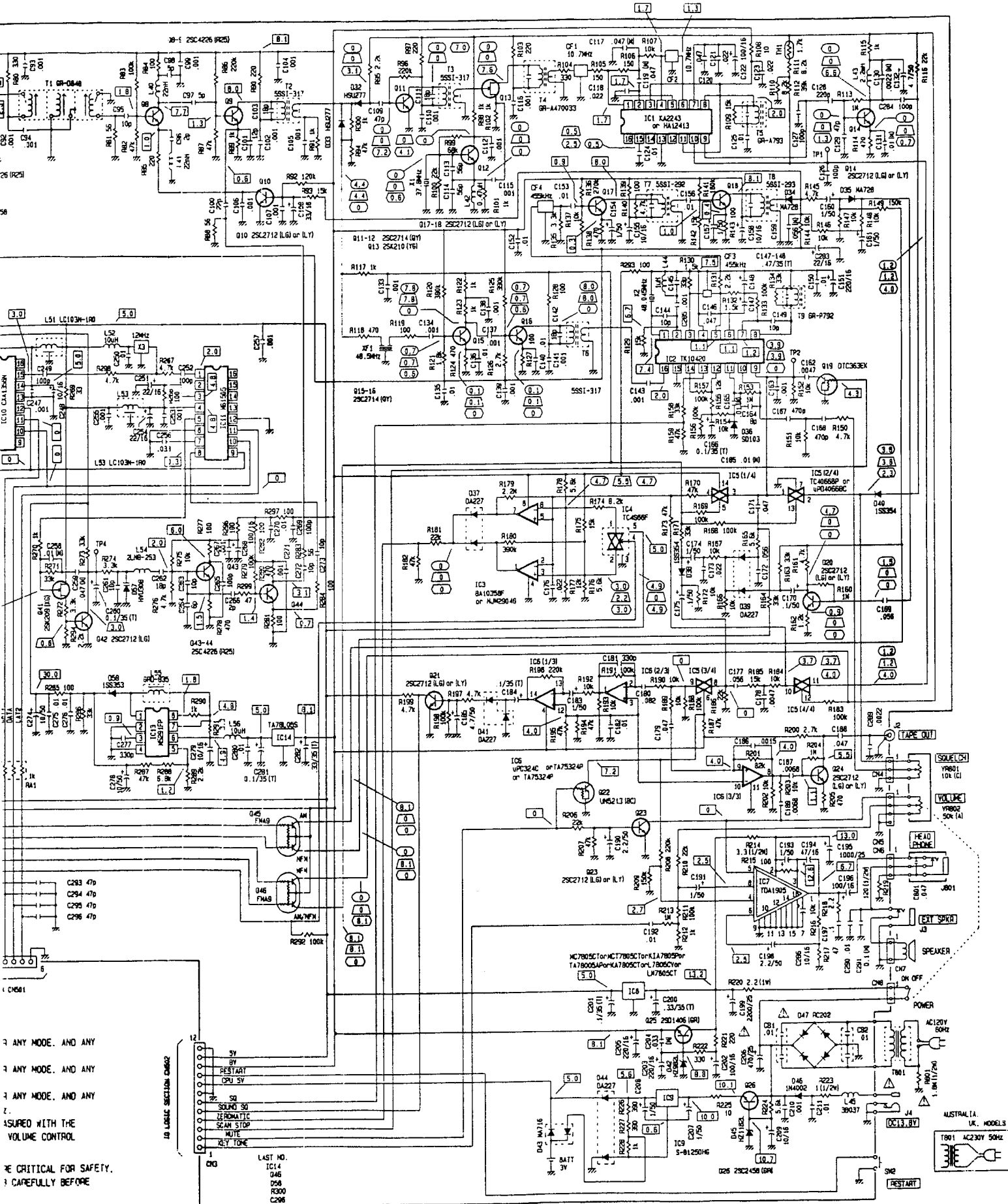

ANY MODE. AND ANY  
 ANY MODE. AND ANY  
 ANY MODE. AND ANY  
 ASSURED WITH THE  
 VOLUME CONTROL  
 RE CRITICAL FOR SAFETY.  
 CAREFULLY BEFORE

10 LOGIC SECTION CHANGE  
 LAST NO.  
 IC14  
 046  
 058  
 R300  
 C296



# SCHEMATIC DIAGRAM

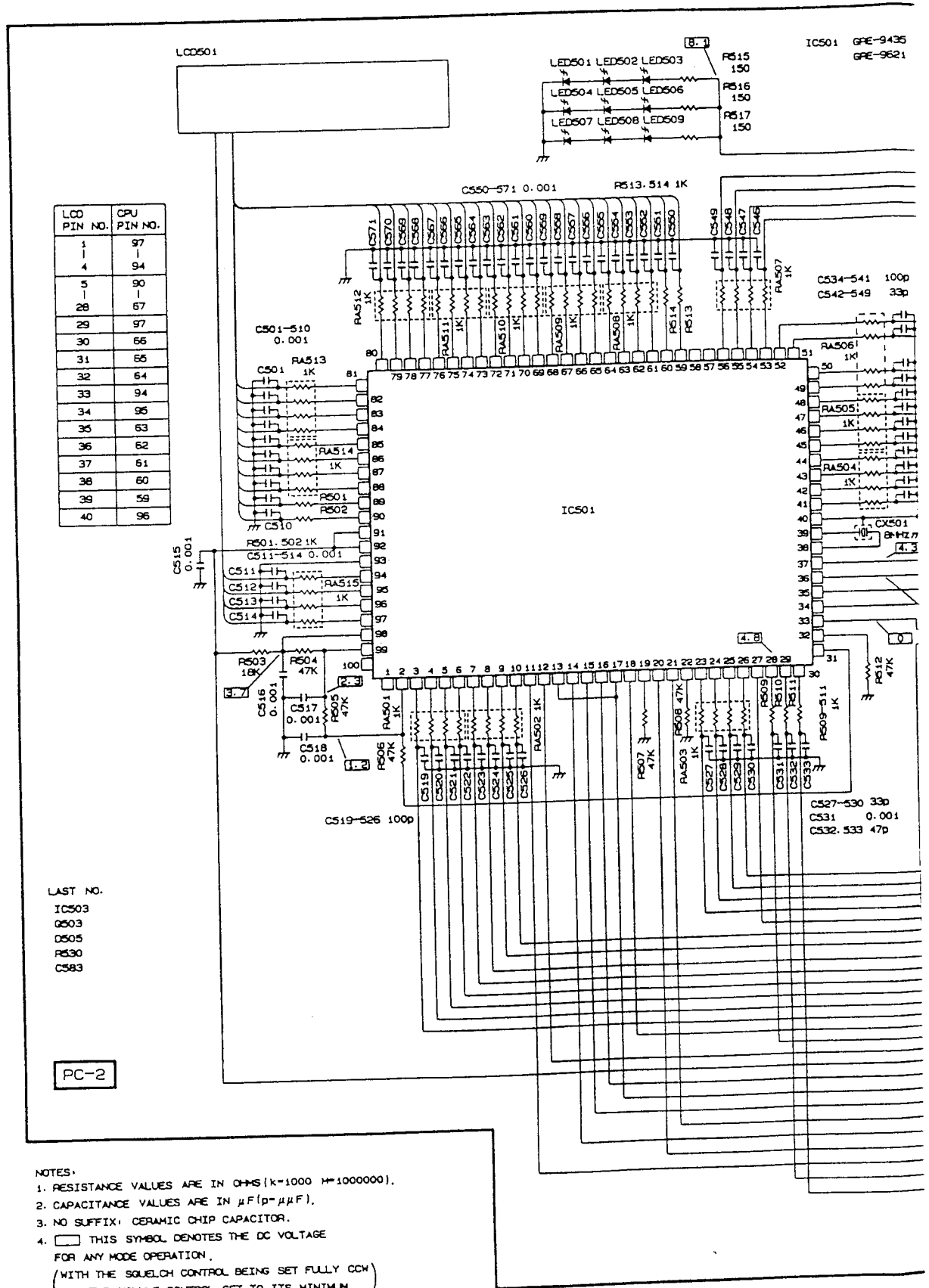

# SCHEMATIC DIAGRAM (LOGIC PCB SECTION)

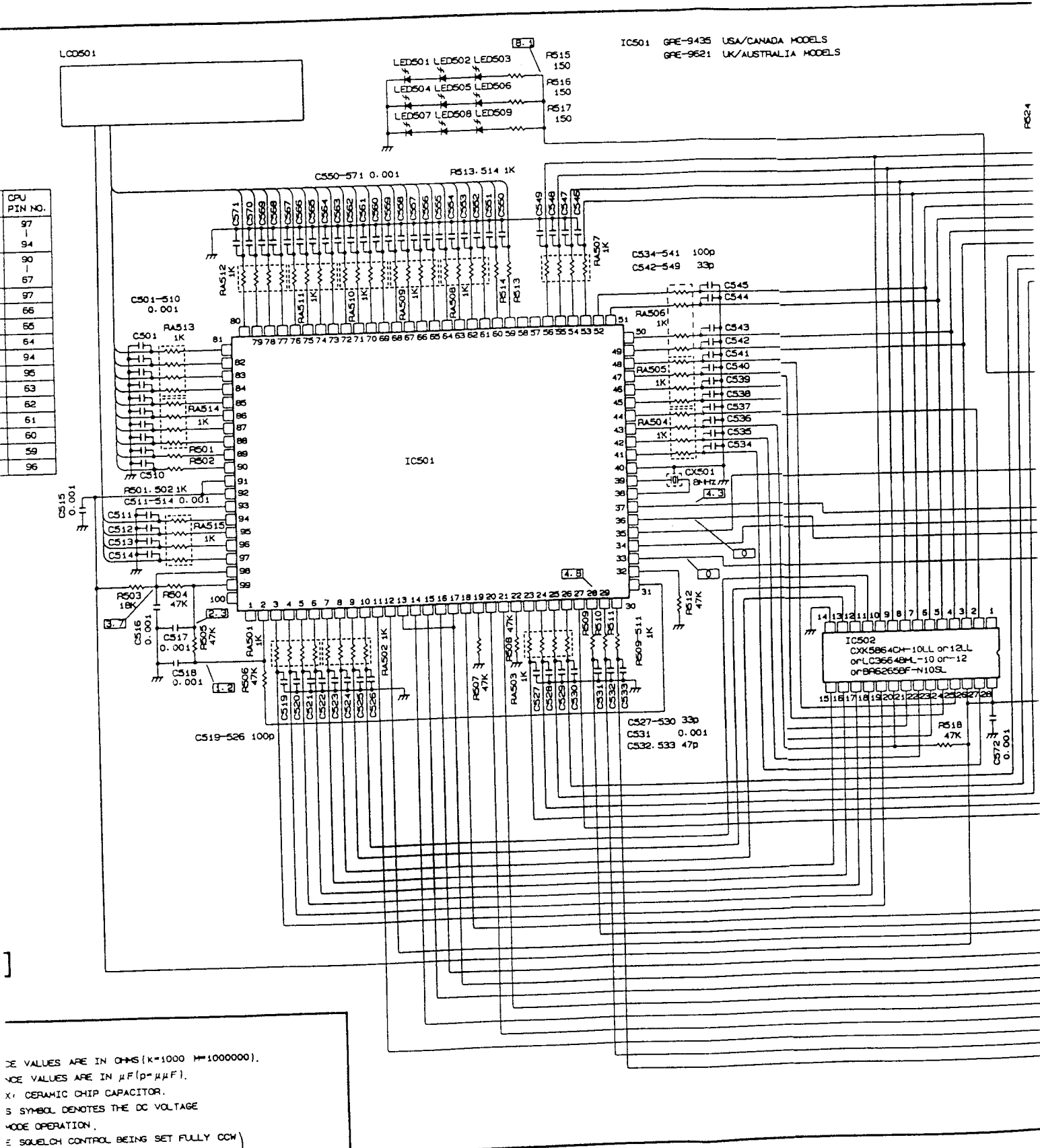

# DIAGRAM (LOGIC PCB SECTION)

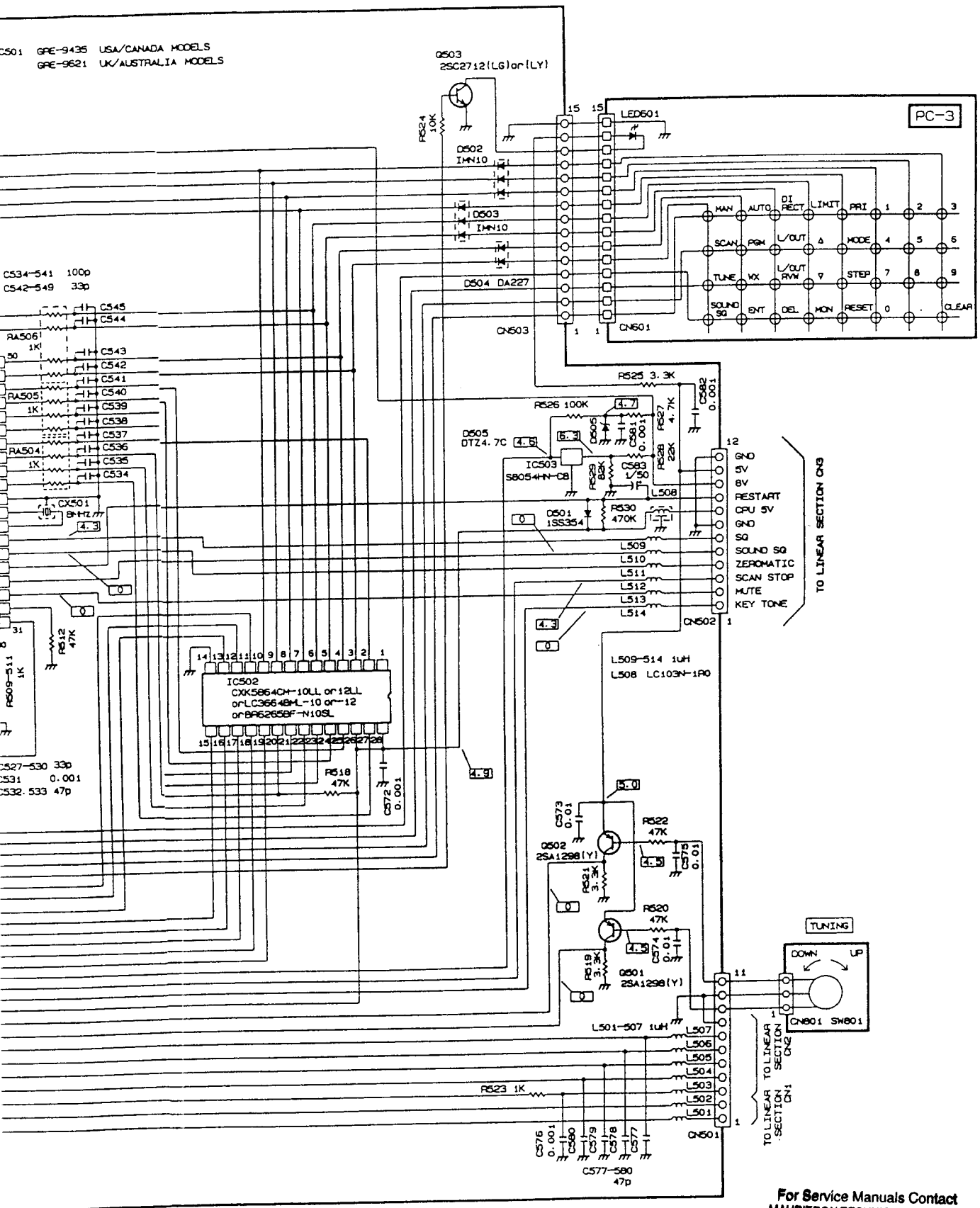

For Service Manuals Contact  
**MAURITRON TECHNICAL SERVICES**  
 8 Cherry Tree Rd, Chinnor  
 Oxon OX9 4QY  
 Tel: 01844-351694 Fax: 01844-352554  
 Email: enquiries@mauritron.co.uk