

Technical Manual

STEREO/MONO POWER AMPLIFIER **RB-951 MKII**

Table of Contents

Specification.....	1
Parts List.....	2~3
Adjustment.....	3
Case Outlines.....	4
PCB Assembly.....	4~6
Schematic Diagram.....	7~8

Specification

Continuous Power Output Stereo Mode (20 - 20 kHz, <0.03% THD)	50 watts/ch into 8 ohms
Continuous Power Output Bridged Mono Mode (20 - 20 kHz, <0.1% THD)	150 watts/ch into 8 ohms
Total Harmonic Distortion (20 Hz : 20 kHz 8 ohms)	<0.03 %
Intermodulation Distortion (60 Hz : 7 kHz 4 : 1)	<0.03 %
Frequency Response (± 1 db)	15 Hz - 100 kHz
Damping Factor (20-20,000 Hz, 8 ohms)	280
Speaker Impedance (combined load)	Stereo mode: 4 ohms minimum Bridged Mono mode: 8 ohms minimum Parallel Mono mode: 2 ohms minimum
Signal to Noise Ratio (IHF A network)	116 dB
Input Impedance	32 k ohms
Input Sensitivity	1.5 volt (low setting) 0.775 volt (high setting)
Auto Turn On Threshold Level (if activated)	10 mV input signal
Auto Turn Off Delay Time (if activated)	5 minutes with no signal
Power Requirements	USA: 115 volts, 60 Hz Europe: 230 volts, 50 Hz
Power Consumption	200 Watts
Dimensions (W x H x D)	440 x 92 x 334 mm 17 ³ / ₈ x 35 ⁸ / ₈ x 131 ⁴ / ₄ in
Weight	6.8 kg/15 lb.

THE ROTEL CO., LTD

SHINSEN-BLD. 4F 10-10 SHINSEN-CHO, SHIBUYA-KU,
TOKYO 150-0045, JAPAN

Serial. NO.
Beginning

Parts List - 1

SYMBOL	PARTS NO.	DESCRIPTION
X-1239-01 PCB ASSEMBLY		
C601,602	043	TC50V331 CAP,CERA.50V330PF
C603,604	043	TC50V221 CAP,CERA.50V220PF
C605,606	041	UTSS1C101-FB CAP,ELEC.16V100UF
C607,608	043	TC50V331 CAP,CERA.50V330PF
C609,610	043	TC50V151 CAP,CERA.50V150PF
C611,612	043	TC50V103 CAP,CERA.50V0.01UF
C613,614	044	50MSAN104J CAP,FILM50V0.1UF
C615,616	043	TC50V101 CAP,CERA.50V100PF
C617,618	041	UTSS1E100-FB CAP,ELEC.25V10UF
C619,620	041	UTSS1E101-FB CAP,ELEC.25V100UF
C621,622	041	UTSS1E470-FB CAP,ELEC.25V47UF
C623,624	041	UTSS1H100-FB CAP,ELEC.50V10UF
C625	043	TC50V473 CAP,CERA.50V0.047UF
C701,702	044	50MSAN104J CAP,FILM50V0.1UF
C703	041	UTSS1E100-FB CAP,ELEC.25V10UF
C704	044	50MSAN104J CAP,FILM 50V0.1UF
C705	041	UTSS1E471 CAP,ELEC.25V470UF
C706	042	TP50V103J CAP,MYLAR50V0.01UF
C708	041	UTSS1E101-FB CAP,ELEC.25V100UF
C710	042	TP50V183J CAP,MYLAR 50V0.018UF
C901-908	043	TC500V103 CAP,CERA.500V0.01UF
C909-912	041	63USP682 CAP,ELEC.63V6800UF
C913,914	041	UTSS1H4R7-FB CAP,ELEC.50V4.7UF
D601-608	034	T1N4148-86 DIODE
D609,610	034	T1N4003-TB DIODE
D621,622	034	TRD5.6JST1 ZENER DIODE
D701,702	034	T1N4148-86 DIODE
D911,912	034	RS403L BRIDGED DIODE
F901,902	036	5ST6.3 MINI FUSE 250VT6.3A
IC601,602	031	MPC1237HA IC
IC701	031	NJM555D IC
L601,602	021	TRL-331 COIL
PJ1,2	066	4TR-2709#2 2P PINJACK
Q601-608	032	TA1016-FG TRANSISTOR
Q609,610	032	B631-EF TRANSISTOR
Q611,612	032	TC1941-KL TRANSISTOR
Q627-632	032	TC536-FG TRANSISTOR
Q633-636	032	TA608-FG TRANSISTOR
Q701-704	032	TC536-FG TRANSISTOR
R601,602	054	TMF1001 R,METAL 1K
R603,604	054	TMF4702 R,METAL 47K
R605,606	054	TMF1500 R,METAL 150R
R607,608	054	TMF4700 R,METAL 470R
R609,610	054	TMF1501 R,METAL 1.5K
R611,612	054	TMF6801 R,METAL 6.8K
R613-616	054	TMF7500 R,METAL 750R
R617-620	054	TMF1002 R,METAL 10K
R621,622	054	TMF47R0 R,METAL 47R
R623,624	054	TMF1000 R,METAL 100R
R625,626	054	TMF4700 R,METAL 470R

SYMBOL	PARTS NO.	DESCRIPTION
R627,628	054	TMF1000 R,METAL 100R
R629,630	054	TMF6801 R,METAL 6.8K
R631,632	054	TMF2201 R,METAL 2.2K
R633,634	054	TMF3302 R,METAL 33K
R635,636	054	TMF1801 R,METAL 1.8K
R637,638	054	TMF1003 R,METAL 100K
R639,640	054	TMF6801 R,META L6.8K
R641-644	054	TMF2200 R,METAL 220R
R645-652	054	2WS0.22JF R,METAL 2W 0.22R
R653,654	054	1WS10JF R,METAL 1W 10R
R655	054	TMF1002 R,METAL 10K
R656	054	TMF6801 R,METAL 6.8K
R657,658	054	TMF5602 R,METAL 56K
R661,662	054	TMF1001 R,METAL 1K
R663-666	054	TMF1502 R,METAL 15K
R667,668	054	TMF3300 R,METAL 330R
R669,670	054	TMF8200 R,METAL 820R
R671,672	054	TMF2202 R,METAL 22K
R673,674	054	TMF1502 R,METAL 15K
R675,676	054	TMF1201 R,METAL 1.2K
R677,678	054	TMF4701 R,METAL 4.7K
R679,680	054	TMF8200 R,METAL 820R
R681,682	054	TMF2702 R,METAL 27K
R683,684	054	TMF4702 R,METAL 47K
R685,686	054	TMF1003 R,METAL 100K
R687,688	054	TMF1203 R,METAL 120K
R689,690	05	4TMF1003 R,METAL 100K
R692	054	TMF47R0 R,METAL 47R
R695,696	054	TMF4703 R,METAL 470K
R701,702	054	TMF1003 R,METAL 100K
R703	054	TMF2203 R,METAL 220K
R704	054	TMF1203 R,METAL 120K
R705	054	TMF1002 R,METAL 10K
R706	054	TMF1000 R,METAL 100R
R707	054	TMF4702 R,METAL 47K
R708,709	054	TMF1003 R,METAL 100K
R710	054	TMF1004 R,METAL 1M
R711	054	TMF4702 R,METAL 47K
R712	054	TMF5603 R,METAL 560K
R717	054	TMF4702 R,METAL 47K
RL,RM	054	TMF1002 R,METAL 10K
RY601,602	063	DG2SU-24 RELAY
S601	064	4TR-2294 SLIDE SWITCH
TH601,602	034	TTC-503 THERMISTOR
VR603,604	051	SFR002-222 SEMI-FIXED RESISTOR 2.2K
	067	4TR-3090 SPEAKER TERMINAL
	068	DM-2GM-O SHORT SOCKET
	069	C-3417A FUSE CLIP

Parts List - 2

SYMBOL	PARTS NO.	DESCRIPTION
X-1239-02 PCB ASSEMBLY		
C001	044 DE7150F472M	SPARK KILLER
S001	061 C-4176A08	POWER SWITCH
X-1239-03 PCB ASSEMBLY		
C707	041 UTE51J221	CAP,ELEC.63V220UF
D704	034 T1N4148-86	DIODE
D705,706	034 T1N4003-TB	DIODE
Q705	032 TC536-FG	TRANSISTOR
R713	054 1WS3.3KJF	R,METAL 1W 3.3K
R714	054 1WS1.2KJF	R,METAL 1W1.2K
R715	054 TMF8201	R,METAL 8.2K
R716	054 TMF2202	R,METAL 22K
RY701	063 DH2U-24	RELAY
X-1277-01 PCB ASSEMBLY		
D1-4	034 LTL4262N	LED
VR001,002	051 C-4170A31	VARIABLE RESISTOR 50KB
X-1277-03 PCB ASSEMBLY		
CON1	067 C-4635A02	2P TERMINAL BLOCK
X-1277-04 PCB ASSEMBLY		
D711	034 T1N4148-86	DIODE
IC702	031 PC817B	PHOTO COUPLER
Q706	032 TA608-FG	TRANSISTOR
R718	054 TMF1001	R,METAL 1K
R719	054 TMF1003	R,METAL 100K
S609	064 C-4660A00	SLIDE SWITCH

SYMBOL	PARTS NO.	DESCRIPTION
HEAT SINKER ASSEMBLY		
Q613-616	033 D600-EF	TRANSISTOR
Q617,618	033 B631-EF	TRANSISTOR
Q619-622	033 D1047-DE	POWER TRANSISTOR
Q623-626	033 B817-DE	POWER TRANSISTOR
	017 RL4-08A00	HEAT SINKER BOARD
	019 TO-126	INSULATION SHEET(S)
	019 TO-3P	INSULATION SHEET(L)
OTHERS		
011	FP-511	FRONT PANEL ASSY
012	SD4-16A00	PUSH BUTTON
014	C-4550A08	UPPER COVER
014	RM4-07B00	BOTTOM BOARD
015	RP-364	PRINTED REAR CHASSIS
019	4TR-2823#2	PLASTIC FOOT 24F
019	4TSH-19#2	PLASTIC FOOT 50F
022	T-1051U02	POWER TRANSFORMER
063	A-0710W-10A	BREAKER
069	C-4629A01	AC INLET
072	C-4621A01	AC CORDSET for STD
072	C-4622A01	AC CORDSET for AUSTRALIA
072	C-4623A01	AC CORDSET for UK
072	C-4624A01	AC CORDSET for CEE
081	SQ4-33A00	INSIDE CARTON
081	TZ-165	STYROL SIDE MOULDING

Adjustment

Instruments : DC milli-voltmeter
 Notes : Prior to Bias Adjustment, run about 5minutes with rated output(8ohms) and warm up Power Transistor and Heat Sink. Set input off.

Step	Coupling	Location	Adjust	Adjust for
1	TP1	X-1239-01 PCB	VR603	DC milli-voltmeter reads 4mV
2	TP2	X-1239-01 PCB	VR604	

Case Outline

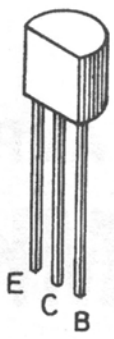

2SC536K
2SA608K
2SA1016K

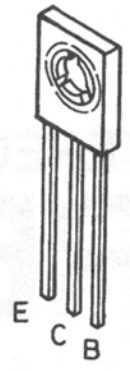

2SB631K
2SD600K

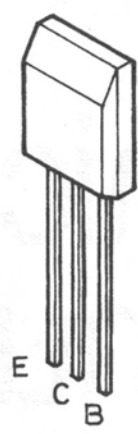

2SC1914

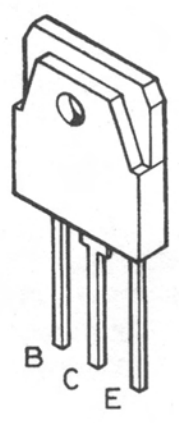

2SB817
2SD1047

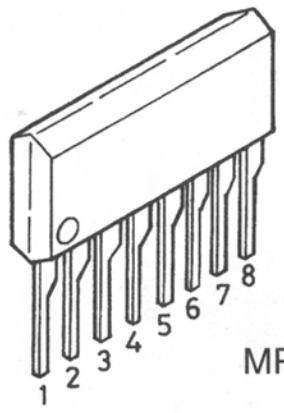

MPC1237HA

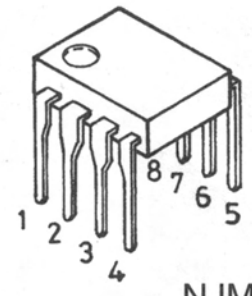

NJM555D

PCB Assembly

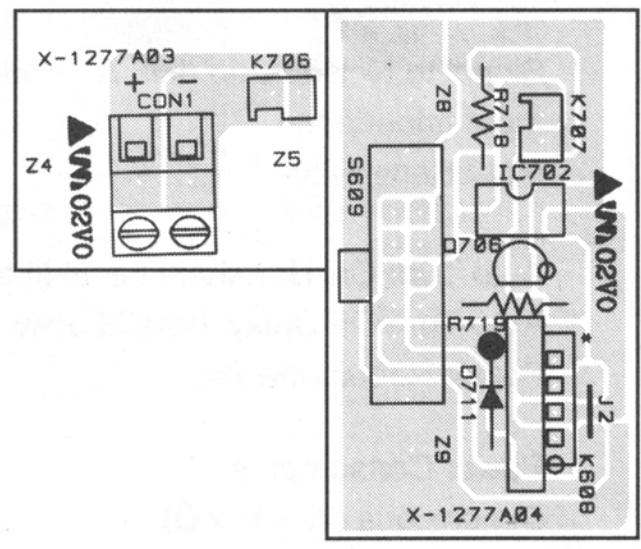
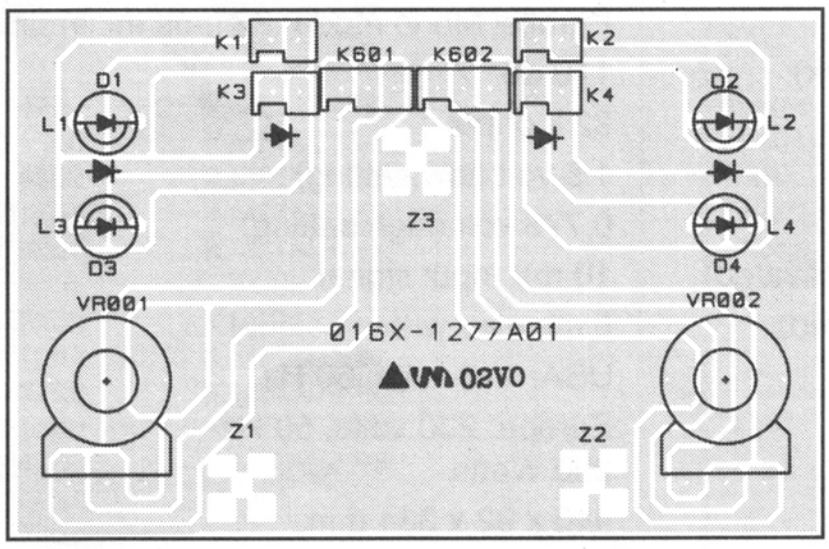

PCB Assembly

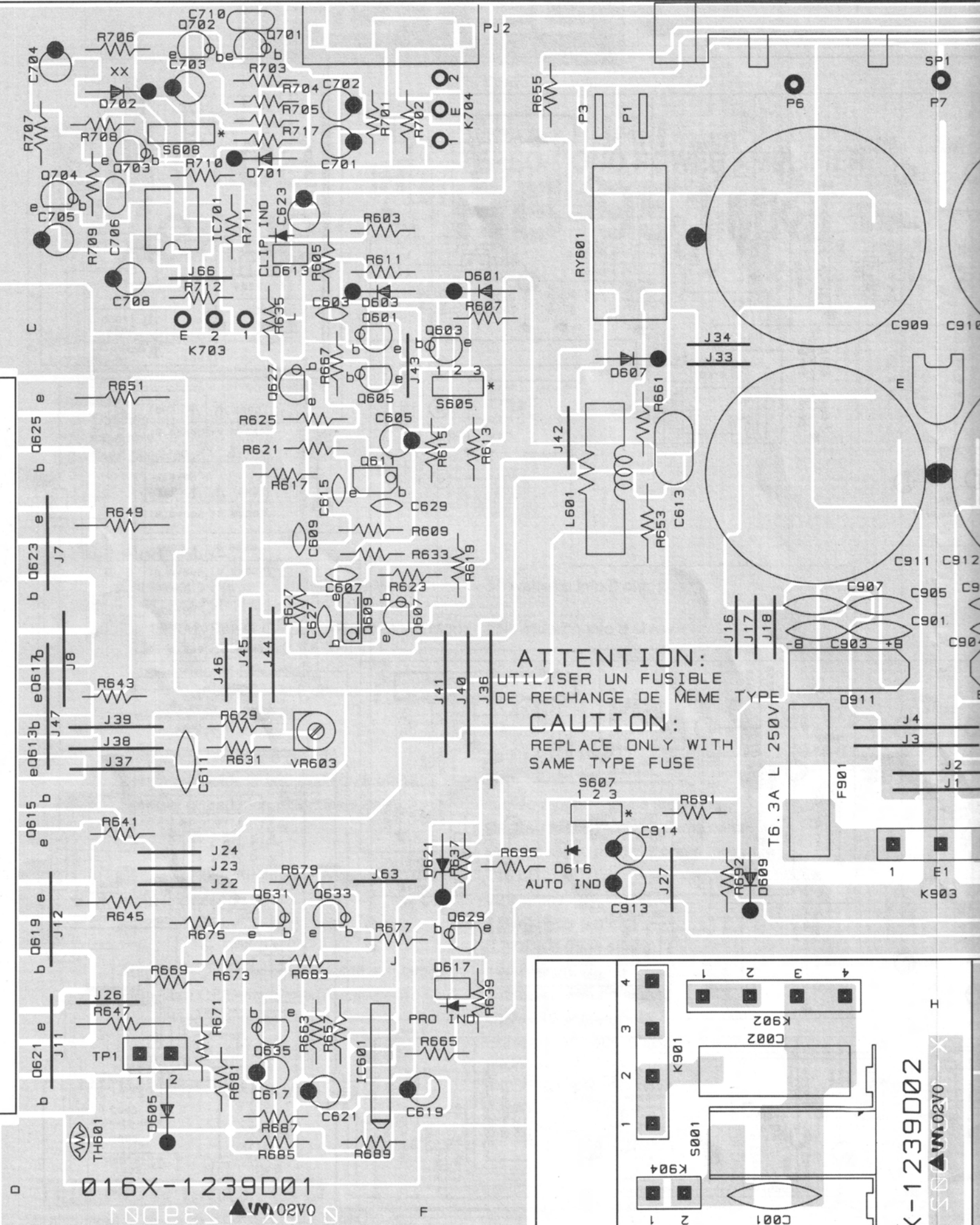

ATTENTION:
 UTILISER UN FUSIBLE
 DE RECHANGE DE MEME TYPE
CAUTION:
 REPLACE ONLY WITH
 SAME TYPE FUSE

T6.3A L 250V

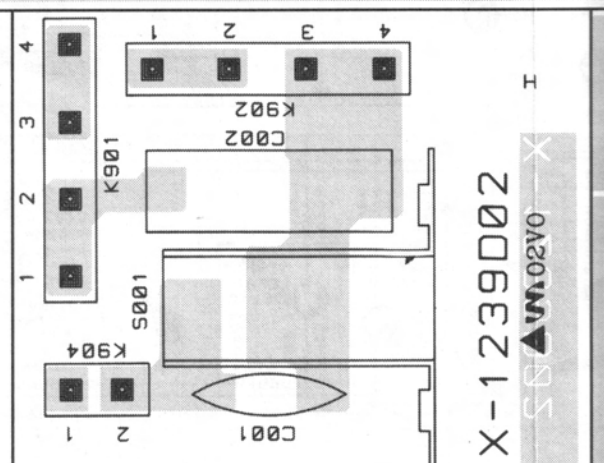

016X-1239001

1002ES X02V0

X-1239002

1002V0

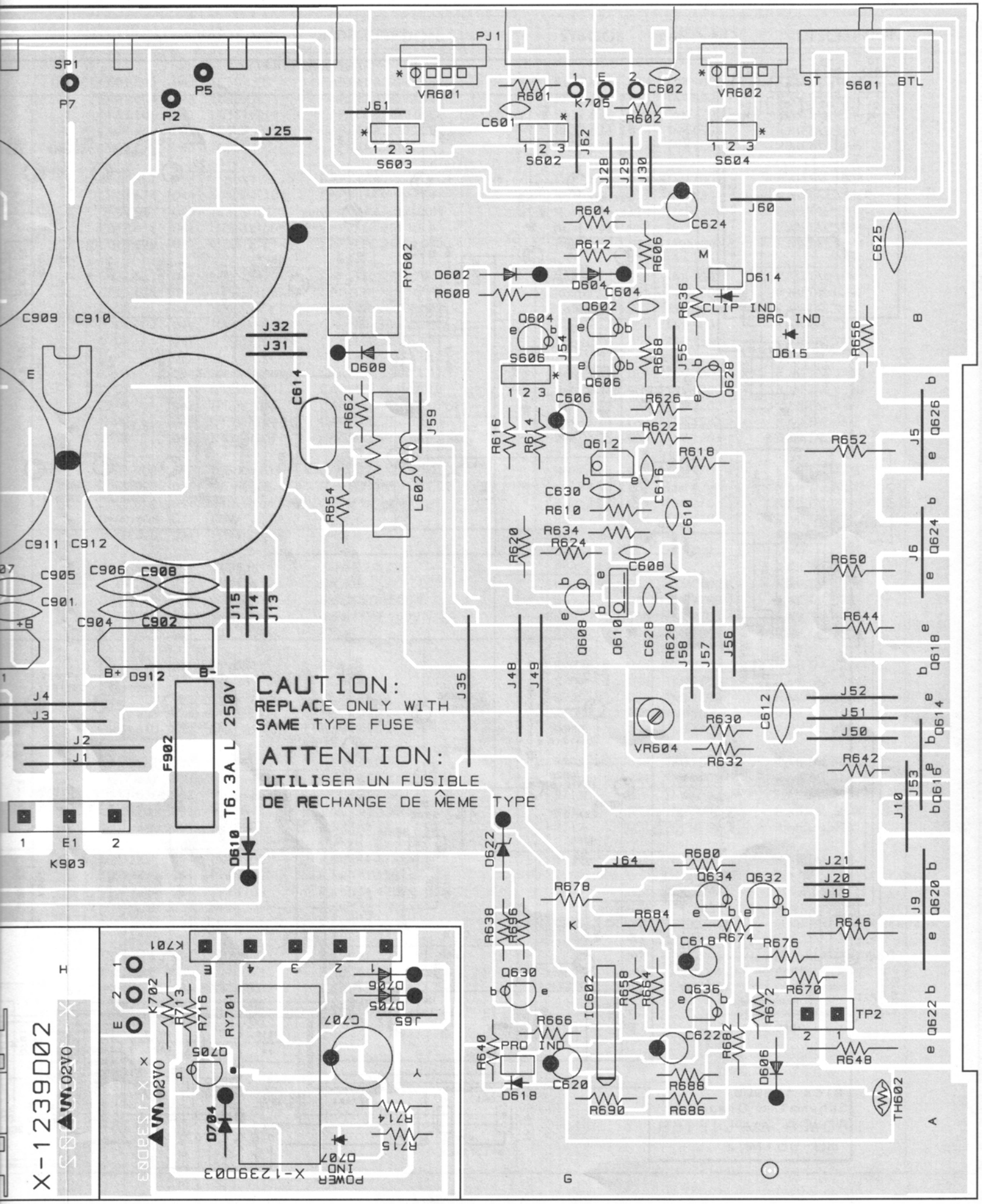

CAUTION:
REPLACE ONLY WITH
SAME TYPE FUSE

ATTENTION:
UTILISER UN FUSIBLE
DE RECHANGE DE MEME TYPE

F902 T6.3A L 250V

X-1239002
S81M.02V0

ES08BET-X X
M.02V0

POWER IND 0707
X-1239003

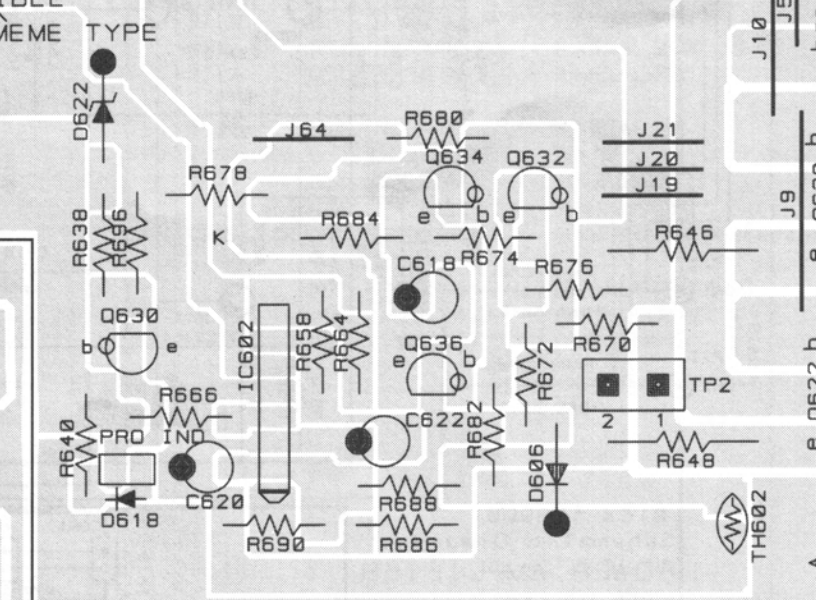
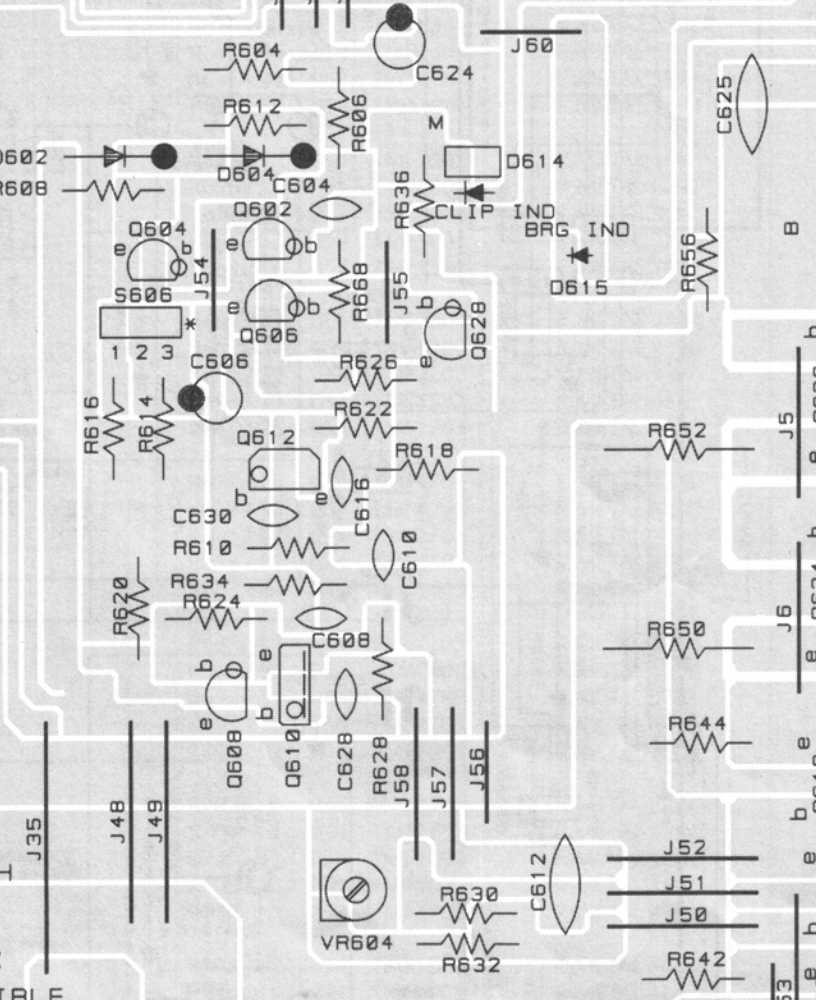
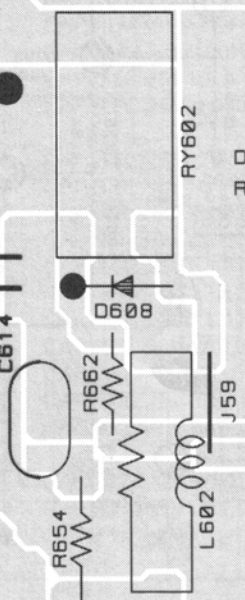
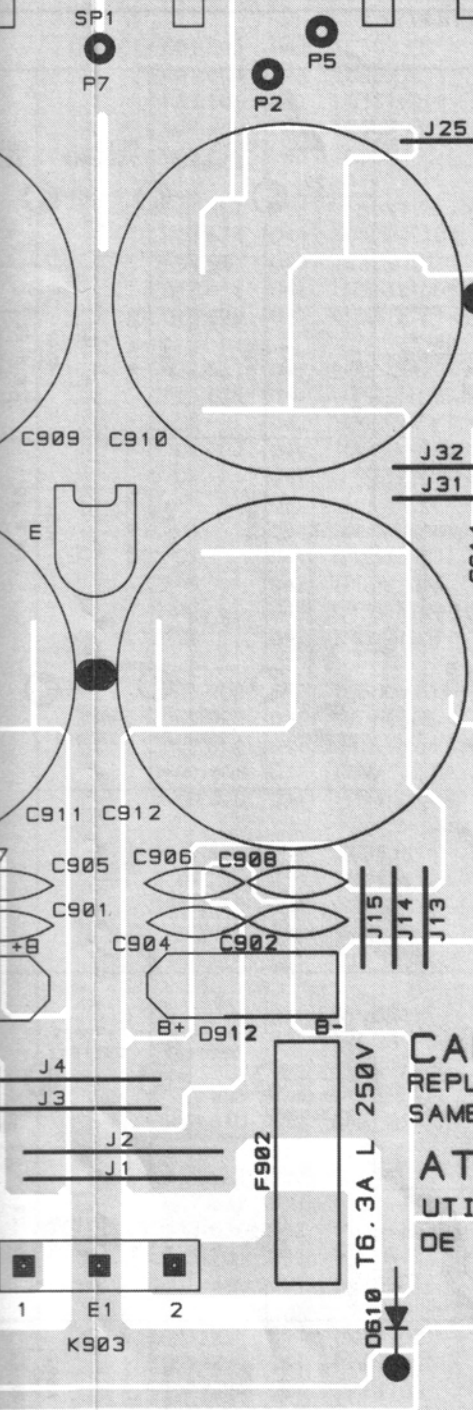

A

G

Schematic Diagram

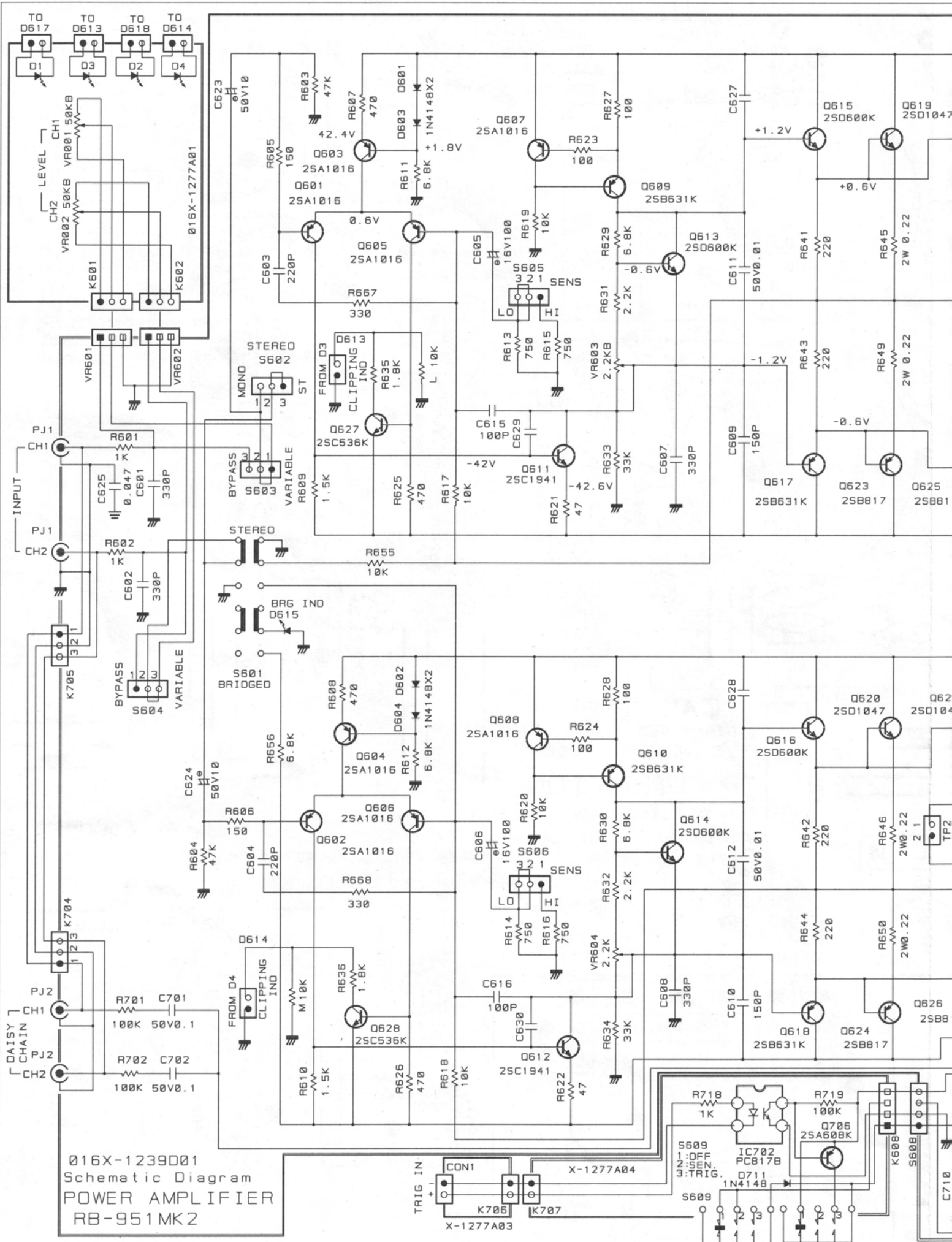

016X-1239001
 Schematic Diagram
 POWER AMPLIFIER
 RB-951MK2

