

Technical Manual

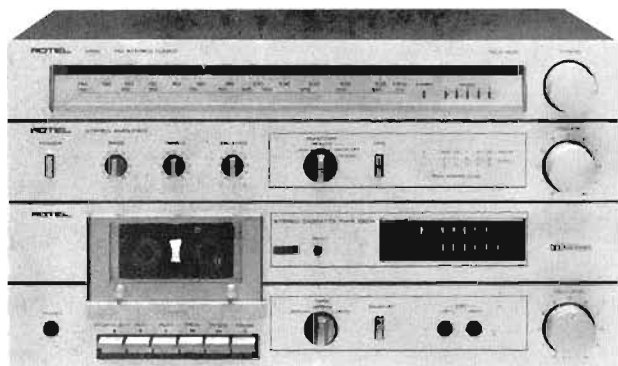

AM/FM STEREO CASSEIVER

RCX-400

MW/LW/FM STEREO CASSEIVER

RCX-400L

TABLE OF CONTENTS

Chassis Layout (1/2)	2	Power Amplifier Bias Adjustment	17
Chassis Layout (2/2)	3	FM IF and RF Alignment/Signal Indicator	
Block Diagram	4	Calibration	18
Dial Stringing Diagram	4	FM MPX Alignment	18
Schematic Diagram	5	Playback System Adjustments	19
Wiring Diagram	10	Recording System Adjustments	19
Disassembly Diagram (1/2)	13	REC/PB System Adjustments	20
Disassembly Diagram (2/2)	14	Repair Parts List	29
AM IF and RF Alignment/Signal Indicator			
Calibration	17		

INHALTSVERZICHMIS

Chassis-Anordnung (1/2)	2	Endverstärker-Vorspannungs-Einstellung	21
Chassis-Anordnung (2/2)	3	UKW-ZF und HF-Einstellung/Signalstärkeanzeige-	
Blockschaltbild	4	Eichung	22
Skalenantriebsschema	4	UKW-MPX-Einstellung	22
Schaltungsschema	5	Wiedergabepegels-Einstellung	23
Drahtleitung Diagramm	10	Aufnahmesystems-Einstellung	23
Illustration des Auseinanderbaus (1/2)	13	Aufnahmesystems und Wiedergabepegels-Einstellung	24
Illustration des Auseinanderbaus (2/2)	14	Reparaturteilliste	29
MW-ZF und HF-Einstellung/Signalstärkeanzeige-			
Eichung	21		

TABLE DES MATIERES

Installation du Châssis (1/2)	2	Réglage de la polarisation de l'amplificateur de	
Installation du Châssis (2/2)	3	puissance	25
Schéma symptotique	4	Alignement FM IF et HF/Indicateur de force	
Diagramme des câbles d'entraînement	4	du signal	26
Diagramme de schématique	5	Alignement FM MPX	26
Diagramme de connexion	10	Réglages de système de la reproduction	27
Schéma de démontage (1/2)	13	Réglages de système de l'enregistrement	27
Schéma de démontage (2/2)	14	Réglages de système de L'enregistrement/	
Alignement AM IF et HF/Indicateur de niveau de		reproduction	28
signal	25	Liste des pièces de rechange	29

Chassis Layout / Chassis-Anordnung / Installation de Chassis (1/2)

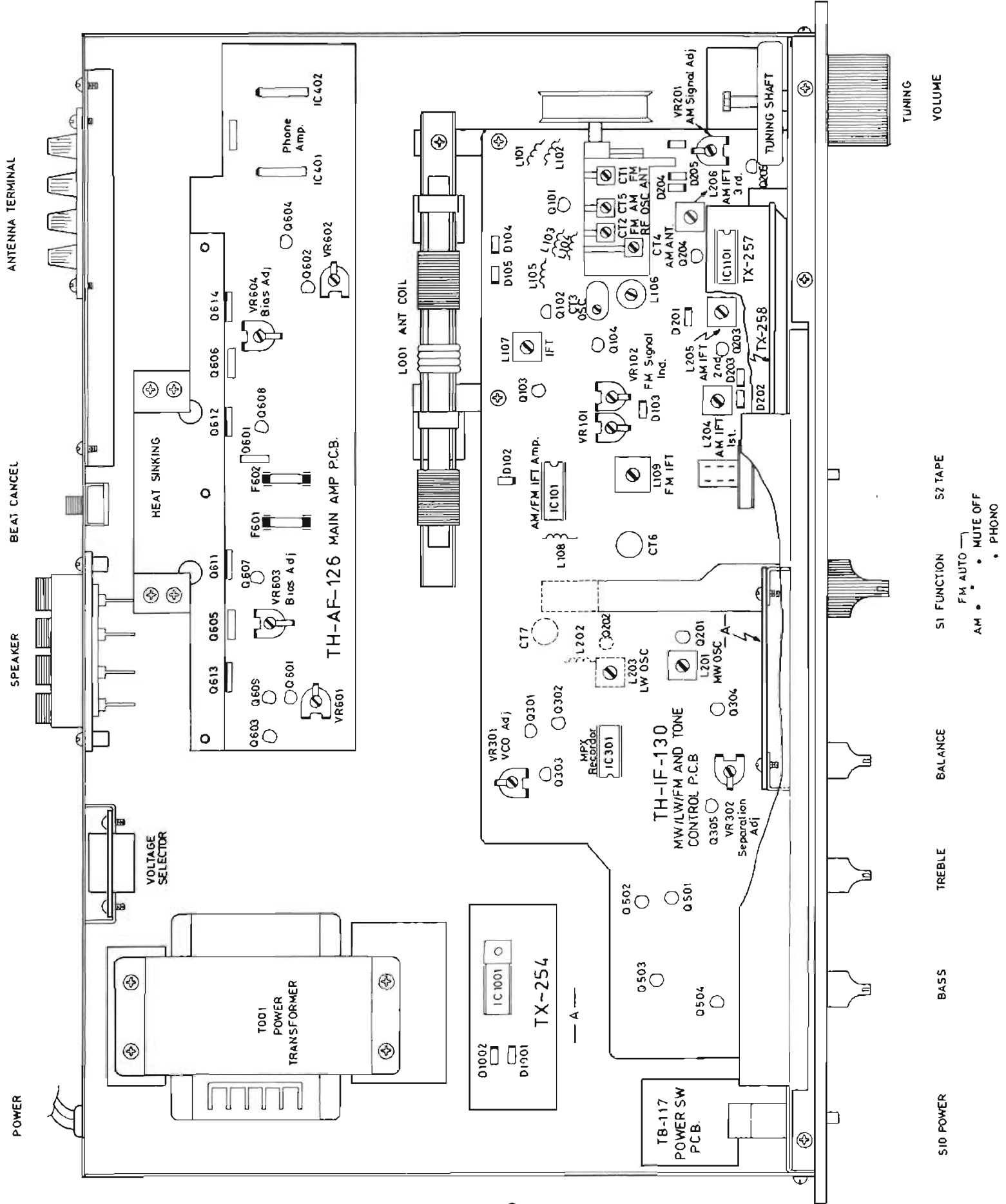

Chassis Layout / Chassis-Anordnung / Installation de Chassis (2/2)

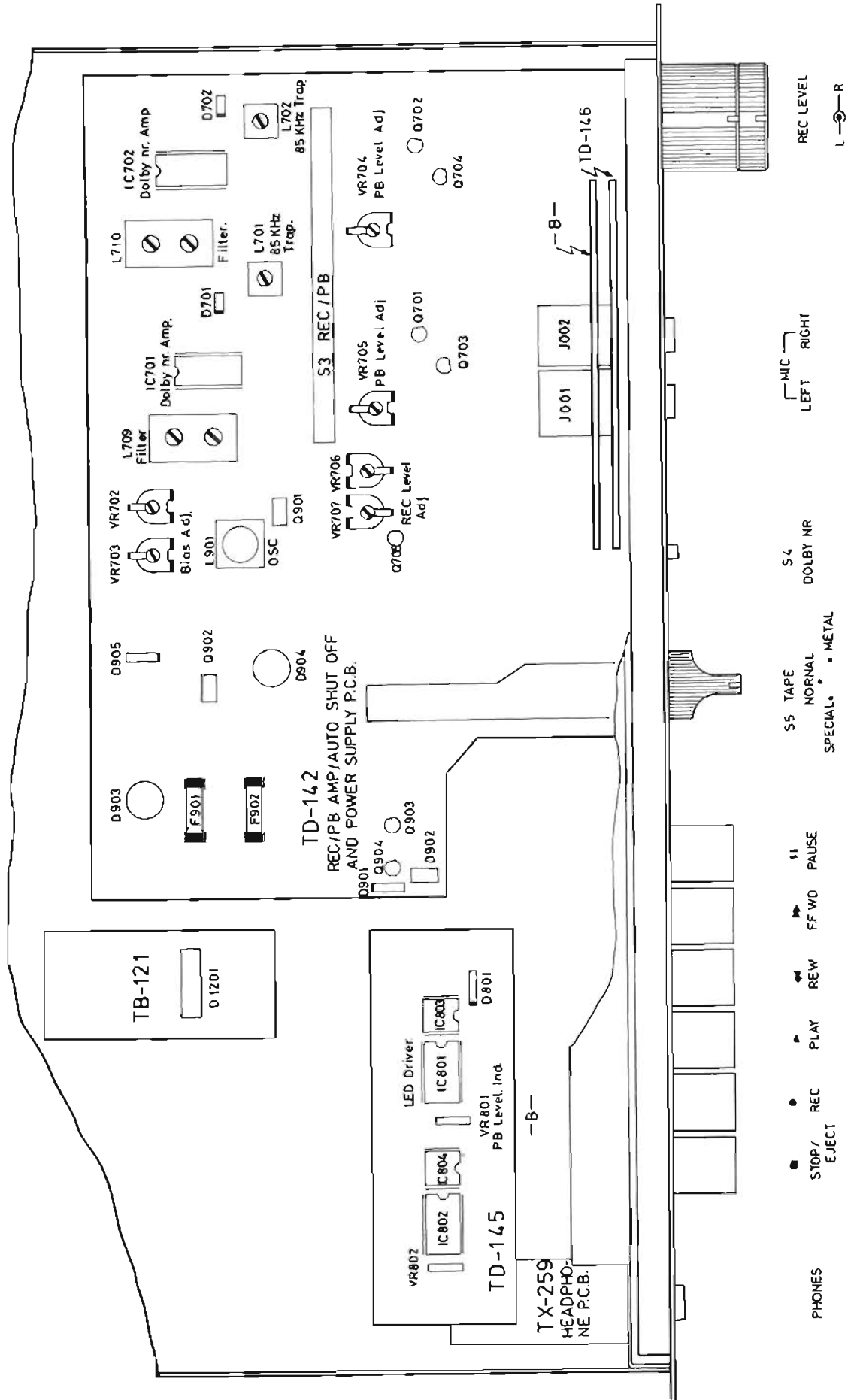

Block Diagram/Blockschaltbild/ Schéma synoptique

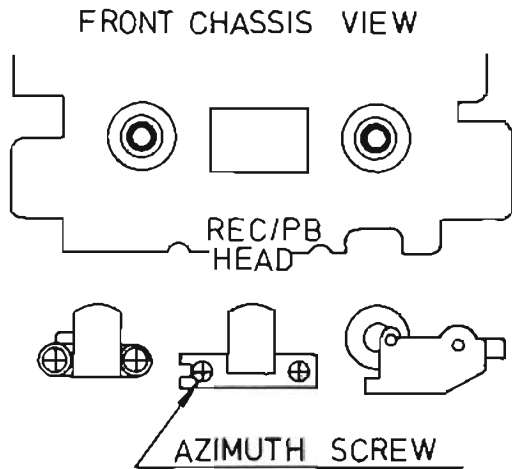
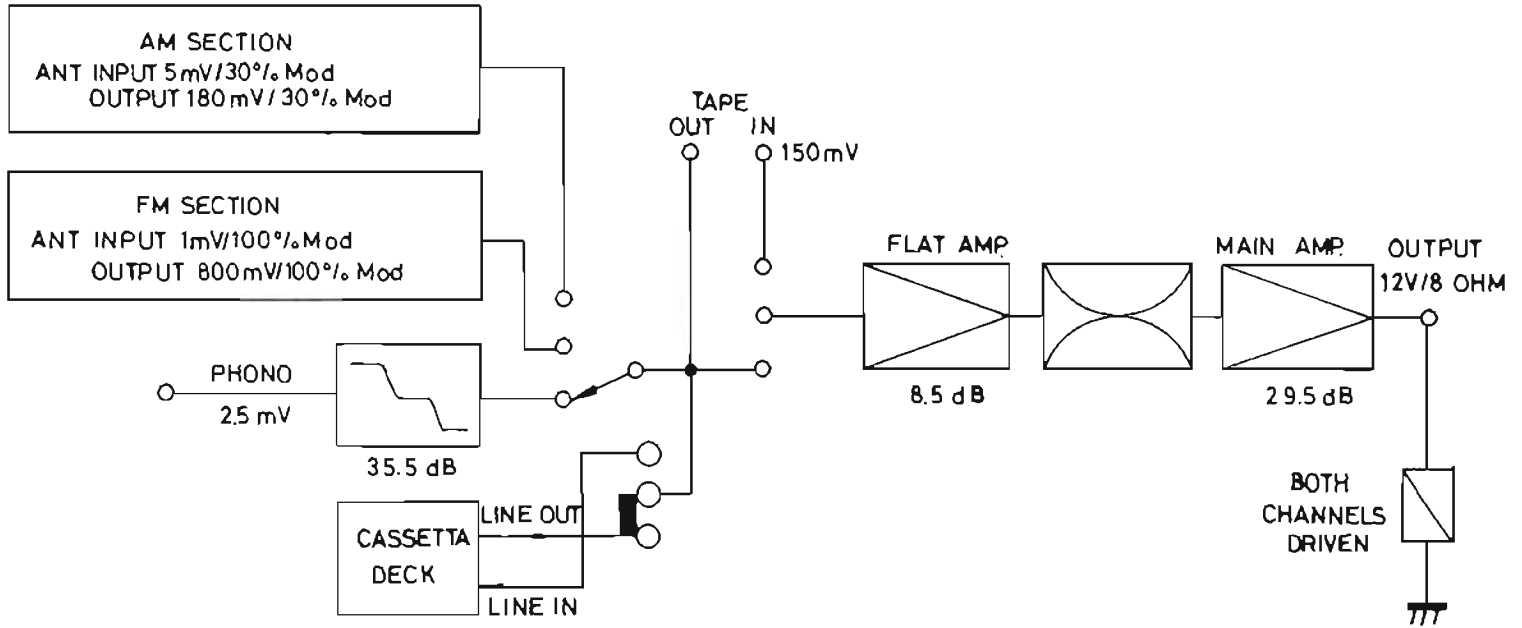

ADJUST AZIMUTH SCREW TO OBTAIN
MAXIMUM DEFLECTION ON SCOPE

Fig. 1 Azimuth Adjustment
Abb. 1 Azimuteinstellung
Fig. 1 Réglage de l'azimut

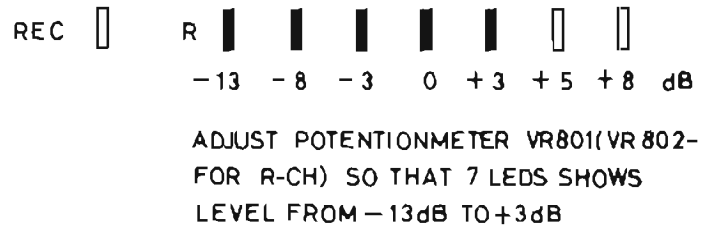

Fig. 2 Dolby Level Adjustment
Abb. 2 Einstellung der Dolby-Regel.
Fig. 2 Réglage du niveau Dolby

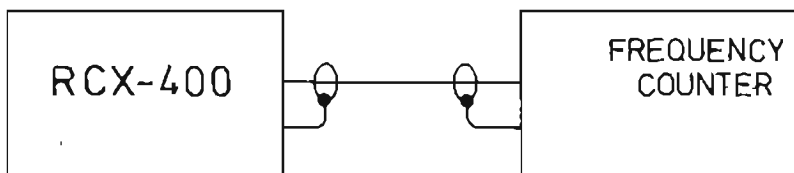
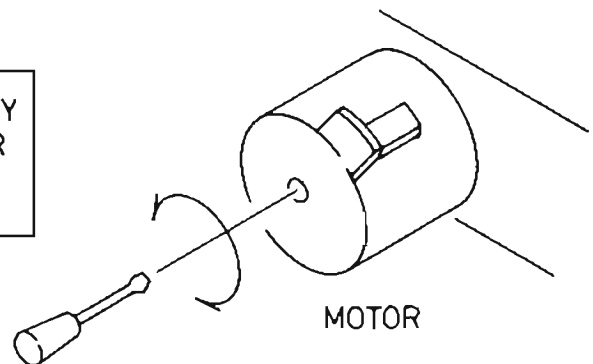
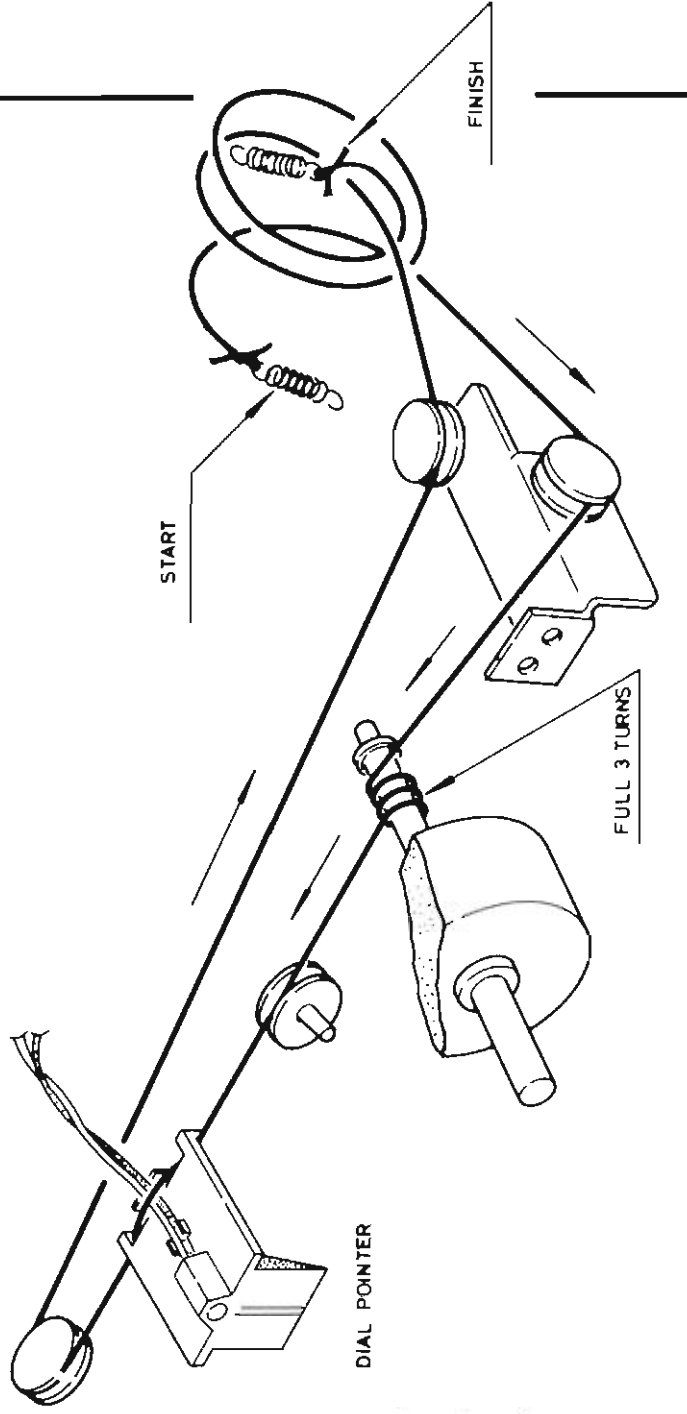

Fig. 3 Tape speed Adjustment
Abb. 3 Einstellung der Bandgeschwindigkeitabweichung
Fig. 3 Réglage de la vitesse de défilement de la bande



Dial Stringing Diagram Skalantriebsschema Diagramme des câble d'entraînement



Note: Carry out stringing with the front end set at VC maximum.

Zur Beachtung: Antriebsseil mit dem Drehko der Eingangs Stufe in Maximumstellung verlegen.

Note: Effectuer le câblage avec le condensateur réglable de l'entrée réglé au maximum.

Schematic Diagram / Schaltungsschema / Diagramme schématique

• SPECIFICATIONS OR WIRING DIAGRAMS OF THIS MODEL ARE SUBJECT TO CHANGE FOR THE IMPROVEMENT WITHOUT PRIOR NOTICE.

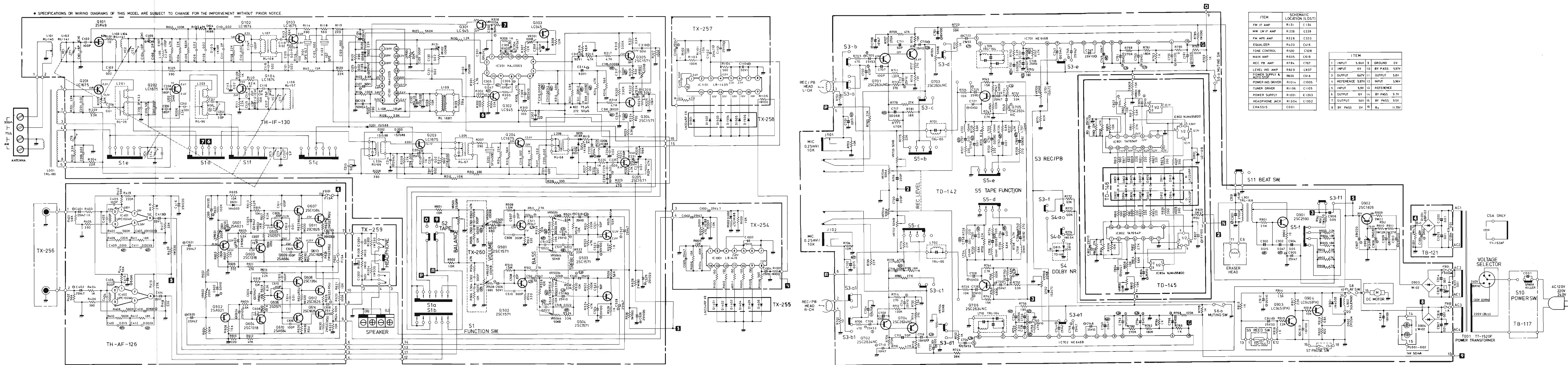

ITEM	SCHEMATIC LOCATION (LOST)
FM IF AMP	R131 C134
MW LF IF AMP	R226 C228
FM MPX AMP	R328 C320
EQUALIZER	R420 C416
TONE CONTROL	R530 C528
MAIN AMP	R635 C619
REC PB AMP	R784 C767
POWER SUPPLY & AUTO STOP	R829 C807
POWER IND. DRIVER	R920 C918
TUNER DRIVER	R1014 C1005
POWER SUPPLY	R1201 C1203
HEADPHONE JACK	R1304 C1302
CHASSIS	C001

ITEM	ITEM
1 INPUT	5.96V
2 INPUT	6V
3 OUTPUT	6.47V
4 REFERENCE	5.87V
5 INPUT	5.9V
6 OUTPUT	6V
7 OUTPUT	5.6V
8 BY PASS	0V
9 GROUND	0V
10 BY PASS	5.97V
11 OUTPUT	5.8V
12 INPUT	5.96V
13 REFERENCE	
14 BY PASS	9.7V
15 BY PASS	9.5V
16 B+	11.79V

THE SCHEMATIC DIAGRAM IS AVAILABLE COMBINATION OF MW/LW/FM UNITS ONLY WHEN UNITS COMBINE JUST AM/FM ONLY THERE WERE MADE SOME MODIFICATIONS AS FOLLOWING:
 1 CHANGED ANTENNA COIL (L001 FROM TRL-180 TO TRL-179)
 2 CANCELLED SWITCHES S11 S1*
 3 SHORTED D AND E & A AND B
 4 CANCELLED RESISTORS R202, 204 AND 206
 CAPACITORS C202, 203, 208, 209, 210 AND 211, 212, 920, 1204, COILS L202, 203 TRANSISTOR Q202 TRIMER C16 AND C17

RESISTORS
 5% TOLERANCE UNLESS OTHERWISE NOTED
 K---KILO OHM
 M---MEGA OHM
 ---COMPOSITION RESISTORS 1/2 WATT
 RSU METAL OXIDE FILM RESISTORS
 NON-MARK LOW NOISE TYPE CARBON RESISTORS
 UNLESS OTHERWISE NOTED IN SCHEMATIC ALL CAPACITANCE VALUES ARE EXPRESSED IN nFD

CAPACITORS
 ---LOW NOISE ELECTROLYTIC CAPACITORS
 ---MYLAR FILM CAPACITORS
 ---POLYSTYRENE FILM CAPACITORS
 ---TANTALUM CAPACITORS
 ---ELECTROLYTIC CAPACITORS
 NON-MARK CERAMIC CAPACITORS
 UNLESS OTHERWISE NOTED IN SCHEMATIC ALL CAPACITANCE VALUES ARE EXPRESSED IN nFD

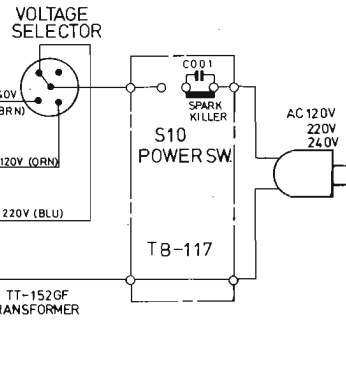
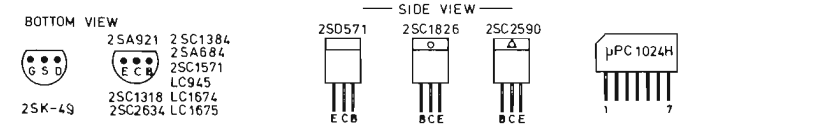

Wiring Diagram / Drahtleitung Diagramm / Diagramme de connexion

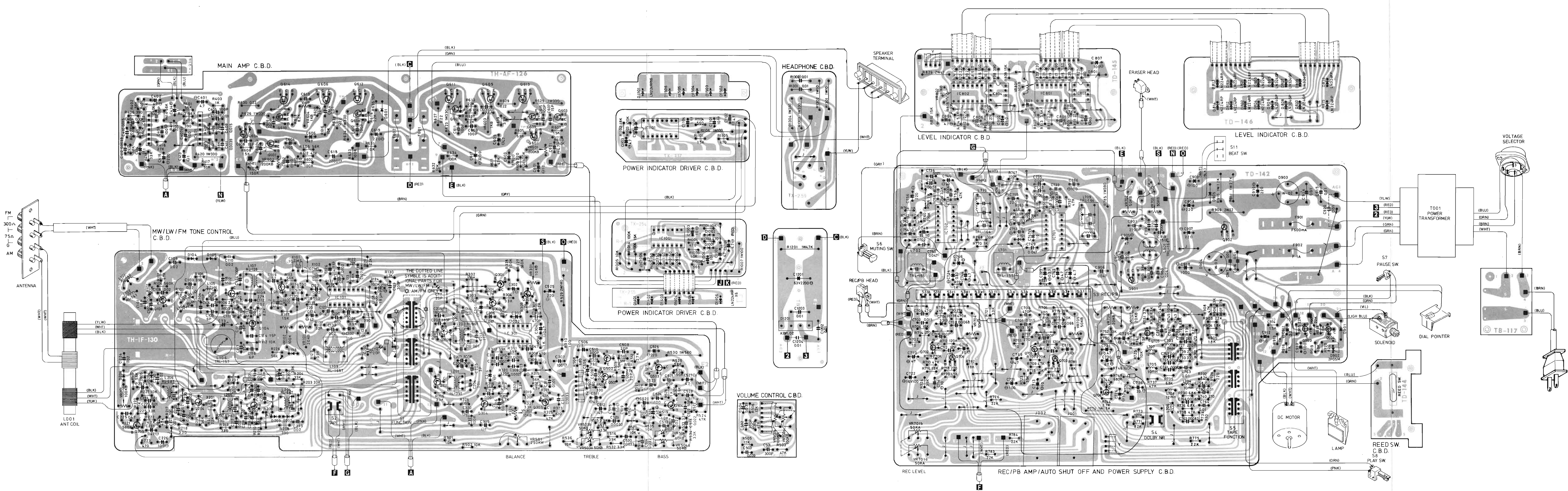

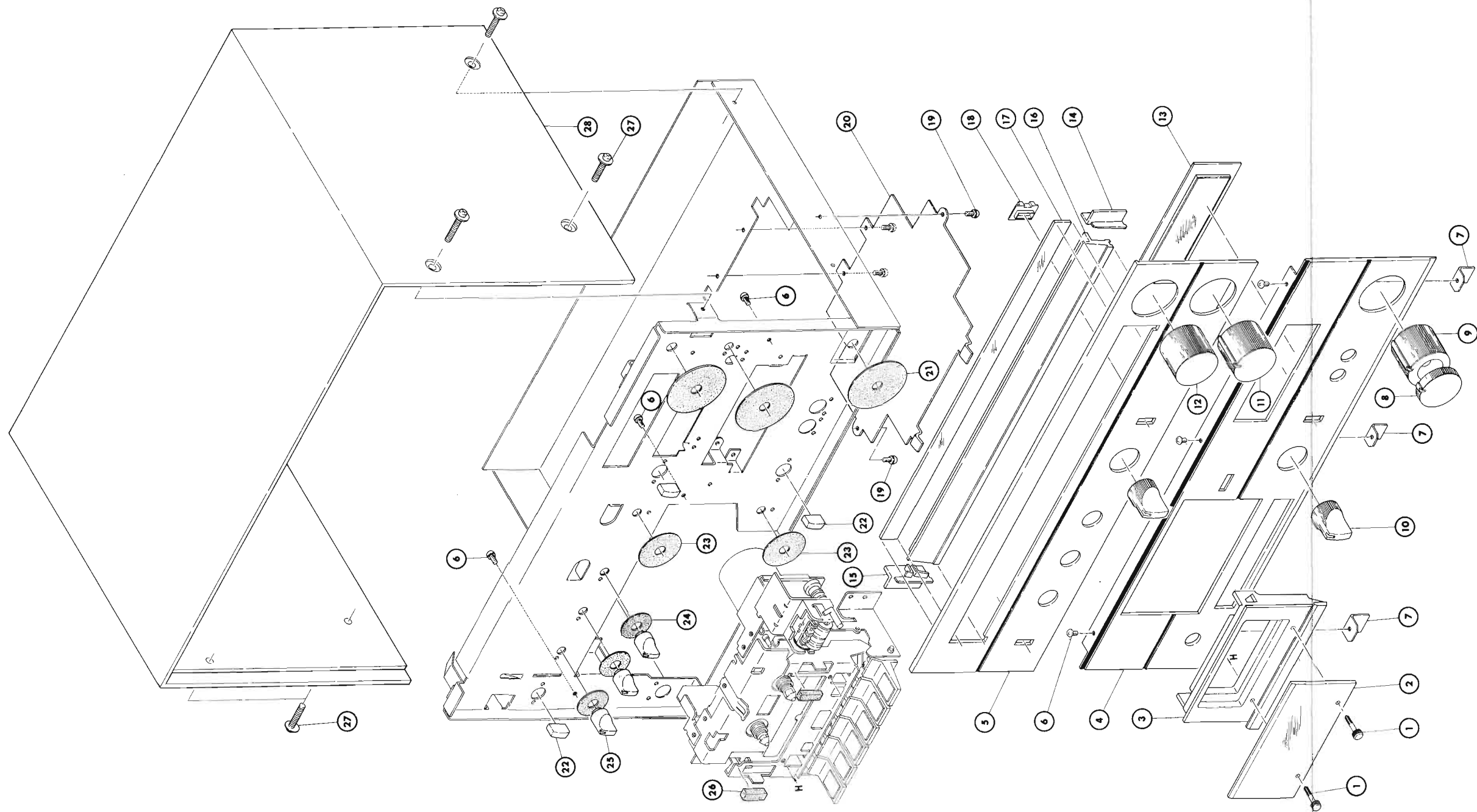

Key No.	Parts No.	Description	Key No.	Parts No.	Description
1	770911233	Ornamental Screw	14	114902359	Dial Board Holder (R)
2	114902398	Acrylic/Door Plate	15	114902358	Dial Board Holder (L)
3	114902325	Tape Holder Cover	16	112011400	Dial Board (FM/MW)
4	111911600	Front Panel (Deck)		112011401	Dial Board (MW/LW/FM)
5	111911601	Front Panel (FM/MW)	17	114902397	Dial Window
6	111911602	Front Panel (FM/MW/LW)	18	114902318	Frame, Push Button
7	705213006	Screw, + M3 x 6 MV	19	725213006	Screw, + M 3 x 6 TPV
7	120013102	Support, Front Panel	20	120013103	Bottom Cover
8	116310353	Knob, 33φ/for REC Level (WL)	21	990201330	Felt, 33φ
9	116310352	Knob, 33φ/for REC Level (WR)	22	116210073	Push Button (for Dolby NR/Power/Tape)
10	116310335	Knob, 20φ (for Function, Tape)	23	990201329	Felt, 20φ
11	116310351	Knob, 33φ (for Volume)	24	990201328	Felt, 13φ
12	116310350	Knob, 33φ (for tuning)	25	116310304	Knob, 13φ (for Bass/Treble/Balance)
13	114902396	Panel Window	26	990201336	Sponge
			27	715224015	Screw, +M 4 x 15 BK
			28	131011379	Cabinet (BEAB)
				131011380	Cabinet

Disassembly Diagram / Illustration des Auseinanderbaus / Schéma de démontage (2/2)

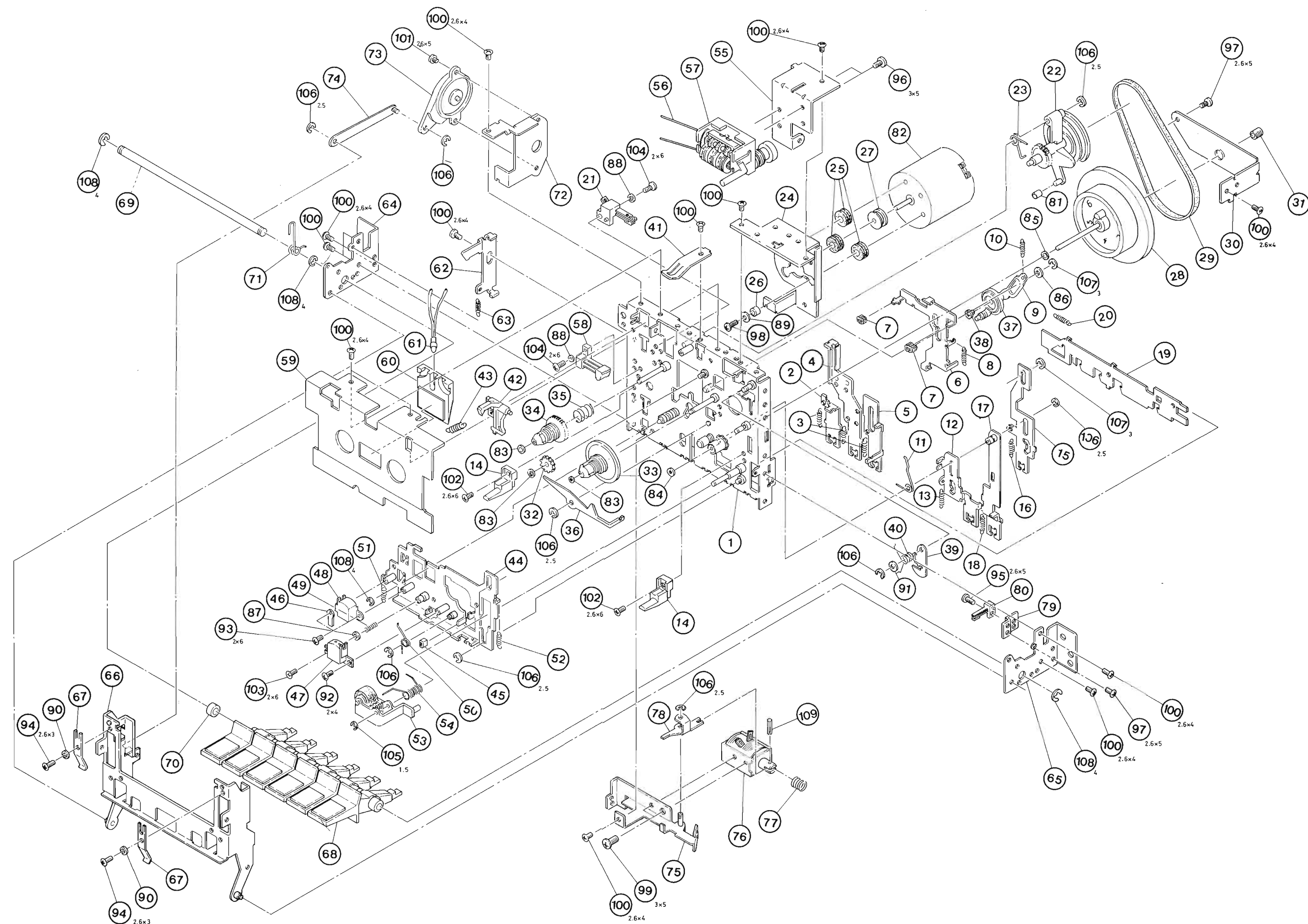

Key No.	Parts No.	Description	Key No.	Parts No.	Description
1	090221101	Ass'y, Chassis	58	615212287	Switch, Leaf
2	090221102	Ass'y Eject Lever	59	090221121	Cover, Dust
3	090226151	Spring, Lever (B)	60	090221122	Light Body, Pilot Lamp
4	090221103	Lever, REC	61	350120006	Pilot Lamp
5	090221104	Lever, Play	62	090221123	Lever (C), Eject
6	090221105	Lever, Brake	63	090226182	Spring (B), Eject Lever
7	090226152	Pad, Brake	64	090221124	Bracket (L), Push Button
8	090226153	Spring, Brake	65	090221125	Bracket (R), Push Button
9	090221106	Arm, Play Idler	66	090221126	Ass'y Cassette Door
10	090226154	Spring, Idler Arm	67	090226182	Spring, Cassette Door
11	090226155	Spring, FF. Tension	68	116210075	Lever, Button
12	090221107	Lever, FF.	69	090226183	Shaft (B), Button
13	090226156	Spring, FF. Lever	70	090227204	Bush, Button
14	090221108	Guide, Cassette	71	090226184	Spring, Cassette Door Up
15	090221109	Lever, REW	72	090221127	Bracket, Damper
16	090226157	Spring, REW Lever	73	090221128	Ass'y, Damper
17	090221110	Ass'y, Pause Lever	74	090221129	Ass'y, Link Door
18	090226158	Spring, Pause Lever	75	090221130	Bracket, Solenoid
19	090221111	Cam Plate (C)	76	240111249	Ass'y, Coil Solenoid
20	090226159	Spring, Cam Plate	77	090226185	Spring, Solenoid
21	615212286	Switch, Leaf	78	090221131	Lever, Auto Stop
22	090221112	Ass'y, Arm Pulley	79	090221132	Bracket, Leaf Switch
23	090226160	Spring, Arm Pulley	80	615212288	Switch, Leaf
24	090221113	Holder (B), Motor	81	090227205	Pad, Brake
25	090226161	Cushion, Motor	82	260101130	Ass'y, DC Motor
26	090227201	Ring, Motor	83	770500079	Washer, PS 1.6 ϕ x3.5 ϕ x0.25 t
27	090226162	Pulley, Motor	84	090227206	Washer, Oil Shield
28	090226163	Flywheel (B)	85	770500080	Washer PS 2.1 ϕ x4 ϕ x0.25 t
29	090226164	Belt, Drive	86	090227207	Washer, 4.1 ϕ x8 ϕ x0.25 t
30	090221114	Bracket, Flywheel	87	090227208	Washer (L), 2 ϕ
31	090227202	Screw, Flywheel and Capstan	88	090227209	Washer (S), 2 ϕ
32	090226165	Idler, FF.	89	090227210	Washer (L), 2.6 ϕ
33	090226166	Ass'y, Reel Take Up	90	090227211	Washer (S), 2.6 ϕ
34	090226167	Ass'y, Reel Supply	91	090227212	Washer (L), 3 ϕ
35	090226168	Spring, Back Tension	92	703202004	Screw, +M2x4 Pan Head
36	090221115	Arm, Pause	93	703202006	Screw, +M2x6 Pan Head
37	090226169	Idler, Play	94	703222603	Screw, +M2.6x3 Pan Head B.L.K
38	090226170	Bush, Idler	95	703202605	Screw, +M2.6x5 Pan Head
39	090221116	Cam, Pause	96	703203005	Screw, +M3x5 Pan Head
40	090226171	Spring, Pause Cam	97	713202605	Screw, +M2.6x5 W/SP W
41	090226172	Spring, Pack Clamp	98	713202608	Screw, +M2.6x8 W/SP W
42	090221117	Arm, REC Sensor	99	713203005	Screw, +M3x5 W/SP W
43	090226173	Spring, REC Sensor Arm	100	763202604	Screw, +M2.6x4 Tap Tite
44	090221118	Ass'y, Sub Chassis and Studs	101	763202606	Screw, +M2.6x6 Tap Tite
45	090226174	Spacer, Sub Chassis	102	763202608	Screw, +M2.6x8 Tap Tite
46	090227203	Clamp, Cord	103	705002006	Screw, -M2x6 Bind
47	241001124	REC/PB Head	104	723202006	Screw, +M2x6 Tpg
48	241001123	Erase Head	105	770500026	E Ring, 1.5 ϕ
49	090226175	Spring, Azimuth	106	770500027	E Ring, 2.5 ϕ
50	090226176	Spring, Panel Tension	107	770500039	E Ring, 3 ϕ
51	090226177	Spring (L), Panel	108	770500040	E Ring, 4 ϕ
52	090226178	Spring (R), Panel	109	090227215	Spring Pin, 2 ϕ x10
53	090221119	Ass'y, Arm Pinch Roller			
54	090226179	Spring, Pinch Roller			
55	090221120	Bracket, Counter			
56	090226180	Belt, Counter			
57	650901118	Tape Counter			

AM IF and RF Alignment / Signal Indicator Calibration

Instruments: AM Signal Generator (400Hz 30% Modulated), AC VTVM and Oscilloscope.

AM IF Alignment (AM/FM, MW/LW/FM)

Step	Generator		Tuning Dial setting	Adjust	Adjust for
	Coupling	Frequency			
1	Pin No. 5 (on IF board through a 0.01 mfd Capacitor	455KHz	No interfering at low end of scale	L204, L205 and L206 (on IF board)	Maximum reading on AC VTVM.

MW RF Alignment (AM/FM, MW/LW/FM)

Step	Generator		Tuning Dial setting	Adjust	Adjust for
	Coupling	Frequency			
1	Test Loop Radiate signal into ferrite loop-stick antenna.	600KHz	600KHz	L201 (OSC) and L001 (ANT) lead line side	Maximum reading on AC VTVM.
2		1400KHz	1400KHz	CT5 (OSC) and CT4 (ANT)	
3	(Input 100mV)	1000KHz	1000KHz	VR201	5 LEDs just light up. (Signal strength indicator.)

LW RF Alignment (MW/LW/FM only)

Step	Generator		Tuning Dial setting	Adjust	Adjust for
	Coupling	Frequency			
1	Test Loop Radiate Signal into ferrite loop-stick antenna.	160KHz	160KHz	L203 (OSC) and L001 (ANT) against the lead line side	Maximum reading on AC VTVM.
2		330KHz	330KHz	CT7 (OSC) and CT6 (ANT)	

Power Amplifier Bias Adjustment

Instruments: DC milli-voltmeter

Notes: Prior to Bias Adjustment, run about 5 minutes with rated output (8 ohm) and warm up Power Transistor and Heat Sink.
Set Volume Control to Minimum.

Step	Coupling		Adjust	Adjust for
	Plus Lead	Minus Lead		
1	TP1	TP2	VR601	DC milli-voltmeter reads 4.4mV.
2	TP3	TP4	VR602	

FM IF and RF Alignment / Tuning and Signal Indicator Calibration

Instruments: FM Signal Generator (400Hz, 100% Modulated), H.D. Analyzer Oscilloscope, AC VTUM and Tuning Meter.

Step	Generator		Tuning Dial setting	Adjust	Adjust for
	Coupling	Frequency			
1	Antenna terminal	90MHz	90MHz	L106 (OSC)	Maximum reading on AC VTUM.
2		106MHz	106MHz	CT3 (OSC)	
3	Repeat steps 1 and 2 until no further improvement is noticed.				
4	Antenna terminal	90MHz	90MHz	L101, L102, L103 and L104 (RF)	Maximum reading on AC VTUM.
5		106MHz	106MHz	CT1 (ANT) and CT2 (RF)	
6		98MHz	98MHz	L106 (OSC)	
7	Repeat steps 4 and 5 until further improvement is noticed.				
8	Antenna terminal (1mV Input)	98MHz	98MHz	L109 (upper core)	Minimum reading on H.D. Analyzer.
9			No interfering	L109 (low core)	Tuning Meter to "Center" position.
10			98MHz	VR102	5 LEDs just light up. (Signal strength indicator)

FM MPX Alignment

Instruments: FM Stereo Generator, AC VTVM and Oscilloscope.

Step	Generator		Tuning Dial setting	Adjust	Adjust for
	Coupling	Frequency			
1	Antenna terminal	98MHz Pilot.....10% 1KHz.....90% Mod.	98MHz	VR301	Stereo indicator light up.
2				VR302	best separation
3	Check the stereo indicator can be operated normally when pilot signal is reduce from 10% to 6%.				

Playback System Adjustments

Instruments: Oscilloscope, AC VTVM, Frequency Counter and Test Tape

Conditions: Oscilloscope, AC VTVM and Frequency Counter . . . LINE OUT Tape Selector . . . NORMAL Dolby NR . . . OFF

Adjustment Item	Test Tape	Adjust	Adjust for
Azimuth	LCT-3004-C	REC/PB head screw	Obtain largest wave form on Oscilloscope for both channels (Fig. 1)
Dolby Level	LCT-7001	VR705 (L-ch) VR704 (R ch)	AC VTVM reads 580mV
LED Calibration		VR801 (L-ch) VR802 (R-ch)	The LEDs indicator corresponds with the Dolby amrk (Fig. 2)
Playback EQ Check	LCT-3009-C	Output Level difference between 40Hz, 1KHz and 10KHz signal is within ± 3.0 dB	
Tape Speed Deflection Check/Tape Speed Adjust	LCT-3001	Check that allowable margin of deflection at middle of or at the end of winding is in the range of +2% – 1% (at 3000Hz allowable margin of deflection of speed is 3060-2970) If Tape Speed deflection surpasses the above range adjust speed of Motor (Fig. 3)	

Recording System Adjustments

Instruments: Oscilloscope, Signal Generator AC VTVM and Blank Tape

Conditions: Dolby NR . . . OFF REC Level . . . Maximum

Adjustment Item	Coupling	Tape Selector	Adjust	Adjust for
Bias Carrier	Oscilloscope . . . Point TP1 (TP2 R-ch)	METAL	L701 (L ch) L702 (R-ch)	Obtain Min. deflection on the Oscilloscope
19KHz Filter	S.G. (400Hz OdB) . . . LINE IN/LINE OUT . . . 580mV Changed S.G. to 19KHz Dolby NR . . . ON	MORMAL.	VR709 (L-ch) VR710 (R-ch)	AC VTVM reads -30dB (Minimum)
Bias Voltage	Oscilloscope . . . Point 3 (4 R-ch)	METAL	VR703 (L-ch) VR704 (R-ch)	AC VTVM reads 6mV

REC/PB System Adjustments

Instruments: Signal Generator, H.D. Analyzer and Blank Tape

Conditions: Dolby NR . . . OFF REC Level . . . Maximum PLAY, REC, PAUSE . . . ON

Adjustment	Conditions	Adjust	Adjust for
REC/PB Output Level	S.G. (400Hz OdB) . . . LINE IN/LINE OUT . . . 580mV Release Pause Button and playback it again.	VR705 (L-ch) VR706 (R ch)	Recording and Playback level difference must be within ± 1 dB
Distortion Check	S.G. (400Hz OdB) . . . LINE IN/LINE OUT . . . 580mV H.D. Analyzer . . . LINE OUT Release Pause Button and playback it again.	Check that distortion is within following range. a. METAL Tape..... under 2% b. SPECIAL Tape..... under 4% c. NORMAL Tape..... under 2%	
	If the distortion factor exceeds the above, recheck Bias Current Adjustment.		
Frequency Response Check	METAL Tape insert it	VR703 (L-ch) VR704 (R-ch)	40Hz–125Hz . . . 5dB 125Hz–10KHz . . .3dB 10KHz–15KHz . . . 5dB
	CrO2 Tape insert it		
	NORMAL Tape insert it		40Hz--125Hz . . . 5dB 125Hz–10KHz . . . 3dB 10KHz–14KHz . . . 5dB

REMARK: (P. 19/20)

TAPE LINE IN: FROM TP. 5 (6).....IN

TAPE LINE OUT: FROM TP. 9 (10).....OUT

MW-ZF und HF-Einstellung/ MW-Signalstärkeanzeige-Eichung

Instrumente: Mw-Messender (400Hz 30% moduliert), Wechselstrom-Roehrevoltmeter und Oszillograph.

MW-ZF Einstellung (MW/UKW, MW/LW/UKW)

Schritt	Messender		Abstimmskalens Einstellung	Abgleich	Abgleich auf
	Anschluss	Frequenz			
1	Steckerstift 5 (auf ZF-leiter- platte ueber 0.01 MF Kon- densator)	455KHz	Kine Interferenz am unteren ska- lenende	L204, L205 und L206 (auf ZF- Leiterplatte)	Maximalanzeige am Roehrevoltmeter

MW-HF Einstellung (MW/UKW, MW/LW/UKW)

Schritt	Messender		Abstimmskalens Einstellung	Abgleich	Abgleich auf
	Anschluss	Frequenz			
1	Mess-Signal mit Schleife in Fer- rit antenna einspeisen.	600KHz	600KHz	L201 (OSZ) und L001 (ANT) Lotleine-Seite	Maximalanzeige am Roehrevoltmeter
2		1400KHz	1400KHz	CT5 (OSZ) und CT4 (ANT)	
3	{Antennenkl- ennenspannung 1mV}	1000KHz	1000KHz	VR201	fünf LEDS leuchtet recht auf. (Signalstärkeanzeige)

LW-HF Einstellung (MW/LW/UKW nur)

Schritt	Messender		Abstimmskalens Einstellung	Abgleich	Abgleich auf
	Anschluss	Frequenz			
1	Mess-Signal mit Schleife in Fer- rit antenna einspeisen	160KHz	160KHz	L203 (OSZ) und L001 (ANT) gegen Lotleine- Seite	Maximalanzeige am Roehrevoltmeter
2		330KHz	330KHz	CT7 (OSZ) und CT6 (ANT)	

Endverstärker-Vorspannung-Einstellung

Instrumente: DC-Gleichstrom-millivoltmeter

Anmerkung: Vor Einstellung der Vorspannung ist das Graet stwa 5 minuten mit nennleistung unter 8 ohm belastung zu betreiben, um die Leistung-stransistoren und Kuehlbleche warm werden zu lassen.

Lautstärke-regler Volumenkontrolle auf Minimum stellen.

Schritt	Anschluss		Abgleich	Abgleich auf
	Pruefstift	Minuspolf		
1	TP1	TP2	VR601	DC-Gleichstrom-millivoltmeter auf 4.4mV einstellen.
2	TP3	TP4	VR602	

UKW-ZF und HF-Einstellung/ Signalstärkeanzeige-Eichung

Instrumente: UKW-Messender (400Hz 100% Moduliert), Klirrfaktormesser, Oszillograph, Wechselstrom-Röhrenvoltmeter

Schritt	Messender		Abstimmskalens Einstellung	Abgleich	Abgleich auf
	Anschluss	Frequenz			
1	Antennenkl- emmen anschliessen	90MHz	90MHz	L106 (OSZ)	Maximalanzeige am Röhrenvoltmeter
2		106MHz	106MHz	CT3 (OSZ)	
3	Schritt 1 und 2 wiederholen, bis keine weitere Verbesserung eintritt.				
4	Antennenkl- emmen ansch- liessen	90MHz	90MHz	L101, L102, L103 and L104 (HF)	Maximalanzeige am Röhrenvoltmeter
5		106MHz	106MHz	CT1 (ANT) and CT2 (HF)	
6		98MHz	98MHz	L106 (OSZ)	
7	Schritt 4 und 5 wiederholen, bis keine weitere Verbesserung eintritt.				
8	Antennenkl- emmen ansch- liessen (Antennenkl- emmen ensp- annung 1mV	98MHz	98MHz	L109 (upper core)	Minimalanzeige am Klirrfaktormesser
9			KEINE Inter- ferenz	L109 (low core)	Abstimmzeiger auf "center" stellen.
10			98MHz	VR102	fünf LEDS leuchtet recht auf. (Signalstärkeanzeige)

UKW MPX-Einstellung

Instrumente: UKW-stereo Messender, Röhrenvoltmeter und Oszillograph.

Schritt	Messender		Abstimmskalens Einstellung	Abgleich	Abgleich auf
	Anschluss	Frequenz			
1	Antennenkl- emmen anschliessen	98MHz Pilotton.....10% 1KHz... ..90% Moduliert.	98MHz	VR301	Stereoanzeige leuchtet auf.
2				VR302	beste Trennung
3	Einwandfreier Stereoanzeigebetrieb muss auch noch gewährleistet sein, wenn der Stereopilotton von 10% auf 6% reduziert wird.				

Wiedergabepiegels-Einstellung

Instrumente: Oszillograph, Wechselspannungsvoltmeter, Frequenz-Zähler und Test-cassette

Bedienung: Oszillograph, Wechselspannungsvoltmeter und Frequenz-Zähler . . . LINE OUT, Bank Wahler . . . NORMAL
Dolby NR Taste . . . OFF

Einstellungsteil	Test-Cassette	Einstellung	Einstellungszweck
Azimut	LCT-3004-C	REC/PB Tonkopfschraube	Maximum-Wellenform auf Oszillograph für beiden Kanäle (Abb. 1) erhalten.
Dolby-Regel	LCT-7001	VR705 (L-K) VR704 (R-K)	Wechselspannungsvoltmeter auf 580mV einstellen.
Zähler-LED		VR801 (L-K) VR802 (R-K)	Der LEDs -Anzeiger auf dem Dolby-Zeichen steht. (Abb. 2)
Prüfung der Wiedergabe "EQ"	LCT-3009-C	Ausgangspegelunterschied zwischen 40Hz, 1KHz und 10KHz darf innerhalb + 3,0dB betragen.	
Überprüfung der Bandgeschwindigkeit /Einstellung der Bandgeschwindigkeitabweichung	LCT-3001	Prüfen, ob Abweichung von der Sollgeschwindigkeit im Bereich + 2%-1% liegt (bei 3000 Hz zwischen 3060-2970 Hz). Bei grösser Abweichung Motorgeschwindigkeit nachstellen (Abb. 3)	

Aufnahmesystems-Einstellung

Instrumente: Oszillograph, NF-Generator, Wechselspannungsvoltmeter und Leercassette.

Bedienungen: Dolby NR Taste . . . OFF Aufnahmepegelregler . . . Maximum

Einstellungsteil	Kupplung	Band-Wähler	Einstellung	Einstellungszweck
Bias-Trägerstrom	Oszillograph . . . Punkt TP 1 (TP 2 R-K)	METAL	L701 (L-K) L702 (R-K)	Min. Abweichung auf Oszillograph erhalten.
19 KHz Filter	NF-Generator (400Hz OdB) . . . an "LINE IN/LINE OUT . . . 580mV NF-Generator auf 19 KHz. Dolby NR . . . ON	NORMAL	VR709 (L-Ch) VR710 (R-Ch)	Wechselspannungsvoltmeter auf -30dB einstellen, (Minimum)
Vorspannung	Oszillograph . . . Punkt 3 (4 R-K)	METAL	VR703 (L-Ch) VR704 (R-Ch)	Wechselspannungsvoltmeter auf 6mV einstellen.

Aufnahmesystems- und Wiedergabepegels-Einstellung

Instrumente: NF-Generator, Klirrfaktormessbrücke und Leer-cassette
 Bedienungen: Dolby NR OFF, Aufnahmespiegel . . . Maximum
 PLAY, REC, PAUSE Taste ON

Einstellung	Bedienungen	Einstellen	Einstellungszweck
Aufnahme/ Wiedergabe Ausgangspegel	NF-Generator (400 Hz 0dB) . . . LINE IN/LINE OUT . . . 580mV Pause-Taste freigeben und spielen es rück noch einmal.	VR705 (L-Ch) VR706 (R-Ch)	Die Differenz der Aufnahme und Wiedergabe-Ausgangspegel innerhalb einer Toleranz von ± 1 dB liegen müssen.
Prüfen des Klirrfaktors	NF-Generator (400 Hz 0dB) . . . LINE IN/LINE OUT . . . 580mV Klirrfaktormessbrücke . . . LINE OUT Pause-Taste freigeben und spielen es rück noch einmal	Prüfen ob Klirrfaktor den folgenden Werten entspricht: a. METAL Band . . . unter 2% b. SPECIAL Band . . . unter 4% c. NORMAL Band . . . unter 2%	
	Wenn der Klirrfaktor die angegebenen Werte übersteigt, dann Vormagnetisierungstrom prüfen.		
Prüfen des Frequenzgangs	METAL Band einschieben	VR703 (L-Ch) VR704 (R-Ch)	40Hz–125Hz . . . 5dB 125Hz–10KHz . . .3dB 10KHz–15KHz . . . 5dB
	CrO2 Band einschieben		
	Normal Band einschieben		40Hz -125Hz . . . 5dB 125Hz–10KHz . . .3dB 10KHz–14KHz . . . 5dB

Alignement AM IF et HF/ Indicateur de niveau de signal

Instruments: Générateur de signal AM (400Hz 30I modulé) AC VTVM et Oscilloscope.

ALIGNEMENT AM IF (AM/FM, MW/LW/FM)

Point	Générateur		Ecran d'accord	Réglage	Réglage pour
	Couplage	Fréquence			
1	Brouche No. 5 (Sur IF plaque- tte par l'inter- médiaire d'un condensateur de 0.01 mfd.	455KHz	Non interférence à l'ex trémité de l'échelle	L204, L205 et L206 (sur la pla- quette IF)	Lecture maximum sur le voltmètre électronique AC VTVM.

Alignement MW RF (AM/FM, MW/LW/FM)

Point	Générateur		Ecran d'accord	Réglage	Réglage pour
	Couplage	Fréquence			
1	Boucle de mesure Envoyée le signal sur ferrite à boucle	600KHz	600KHz	L201 (OSC) et L001 (ANT) Côté de ligne de connexion	Lecture maximum sur AC VTVM.
2		1400KHz	1400KHz	CT5 (OSC) et CT4 (ANT)	
3	(absorbé 100mV)	1000KHz	1000KHz	VR201	5 LEDS allument seule- ment. (Indicateur de force du signal)

Alignement LW RF (MW/LW/FM seulement)

Point	Générateur		Ecran d'accord	Réglage	Réglage pour
	Couplage	Fréquence			
1	Boucle de mesure Envoyée le signal sur ferrite à boucle	160KHz	160KHz	L203 (OSC) et L001 (ANT) contre le côté de ligne de connex- ion	Lecture maximum sur AC VTVM.
2		330KHz	330KHz	CT7 (OSC) et CT6 (ANT)	

Réglage de la polarisation de l'amplificateur de puissance

Instrument: DC milli-voltmètre

Note: Avant le réglage de la polarisation, passer à peu près 5 minutes avec une proportion de la sortie du courant (8 ohm) et réchauffer le transistor de puissance et le snk.
Mettre le contrôle de l'étendue au minimum.

Point	Couplage		Réglage	Réglage pour
	Positif	Moins		
1	TP1	TP2	VR601	DC-millivoltmeter lit 4.4mV.
2	TP3	TP4	VR602	

Alignement FM IF et HF /

— Indicateur de force du signal

Instruments: (400Hz, 100% modulé) Analyseur H.D., Oscilloscope, AC VTVM et Compteur de syntonisation.

Point	Générateur		Ecran d'accord	Réglage	Réglage pour
	Couplage	Fréquence			
1	Borne d'antenne	90MHz	90MHz	L106 (OSC)	Lecture maximum sur AC VTVA
2		106MHz	106MHz	CT3 (OSC)	
3	Répéter les points 1 et 2 jusqu'aucun perfectionnement est marqué.				
4	Borne d'antenne	90MHz	90MHz	L101, L102, L103 et L104 (RF)	Lecture maximum sur AC VTVM.
5		106MHz	106MHz	CT1 (ANT) et CT2 (RF)	
6		98MHz	98MHz	L106 (OSC)	
7	Répéter les points 4 et 5 jusqu'aucun perfectionnement est marqué				
8	Borne d'antenne 1mV absorbée	98MHz	98MHz	L109 (Nogan bas)	Lecture maximum sur AC VTVM.
9			non interférence	L109 (Nogan bas)	Lecture de syntonisation à la position "centrale"
10			98MHz	VR102	5 LEDS allument seulement (Indicateur de force du signal)

Alignement FM MPX

Instruments: FM stéréo Générateur, AC VTVM et Oscilloscope.

Point	Générateur		Ecran d'accord	Réglage	Réglage pour
	Couplage	Fréquence			
1	Borne d'antenne	98MHz lampe témoin 10% 1 KHz 90% Mod.	98MHz	VR301	Indicateur stéréo allume
2				VR302	Séparation la plus meilleure
3	Examiner l'indicateur stéréo peut être opéré normalement lorsque le signal de lampe témoin est réduite de 10% à 6%				

— Réglages de système de la reproduction —

Instruments: Oscilloscope, Voltmètre électronique à courant alternatif, Analyseur de fréquence et bande d'essai.

Conditions: Oscilloscope, Voltmètre électronique à courant alternatif et analyseur de fréquence . . . LINE OUT
 selecteur de bande . . . NORMAL Dolby NR . . . OFF

Item de réglage	Bande d'essai	Régler	Régler pour
Azimut	LCT-3004-C	Vis de tête de Enregistrement/reproduction	Obtenir forme d'onde la plus grande sur l'oscilloscope pour les deux canaux (fig. 1)
Niveau de Dolby	LCT-7001	VR705 (canal gauche) VR704 (canal droit)	Le voltmètre électronique à courant alternatif lit 580mV.
Calibrage de LED		VR801 (canal gauche) VR802 (canal droit)	LEDS Indicateur correspond à la marque Dolby (fig. 2)
Contrôle de l'égalisation de reproduction	LCT-3009-C	Différence de niveau de sortie entre les signaux 40 Hz, 1 KHz et 10KHz est dans $\pm 3.0dB$	
Contrôle de la Variation de la vitesse de bande/réglage de la vitesse	LCT-3001	Vérifier que la marge admissible de variation au milieu ou à la fin de bobinage est dans la plage donnée de +2%–1% (à 3000 Hz marge admissible de variation de la vitesse est 3060-2970). Si la variation de vitesse de bande dépasse la plage donnée ci-dessus, régler la vitesse de moteur. (fig. 3)	

Reglages de système de l'enregistrement

Instruments: Oscilloscope, Générateur de signal, voltmètre électronique à courant alternatif et bande vierge

Conditions: Dolby NR . . . OFF Niveau de l'enregistrement . . . maximum

Item de réglage	Accouplement	Selecteur de bande	Régler	Régler pour
Ports-Polarisation	Oscilloscope . . Point TP 1 (TP 2 canal droit)	METAL	L-701 (canal gauche) L-702 (canal droit)	Obtenir la variation min. sur l'oscilloscope
Filtre 19KHz	Générateur de signal (400Hz OdB) . . LINE IN/LINE OUT . . . 580mV Changé le générateur de signal à 19KHz Dolby NR . . . ON.	NORMAL	VR709 (L-Ch) VR710 (R-Ch)	Voltmètre électronique à courant alternatif lit –30dB (minimum)
Voltage de polarisation	Oscilloscope . . . Point 3 (4 Canal droit)	METAL	VR703 (L-Ch) VR704 (R-Ch)	Voltmètre électronique à courant alternatif lit 6mV

Réglages de système de l'enregistrement/reproduction

Instruments: Générateur de signal, analyseur H.D., et bande vierge

Conditions: Dolby NR . . . OFF

Niveau de l'enregistrement . . . maximum

Reproduction, enregistrement, pause . . . ON

Réglage	Conditions	Régler	Régler pour
Niveau de la sortie de l'enregistrement/reproduction	Générateur de signal (400 Hz OdB) . . . LINE IN/LINE OUT . . . 580mV Relâcher le bouton de pause et reproduire encore.	VR705 (L-Ch) VR706 (R-Ch)	Différence de niveau de l'enregistrement et reproduction doit être dans ± 1 dB.
Contrôle de la déformations	Générateur de signal (400 Hz OdB) . . . LINE IN/LINE OUT . . 580mV Analyseur H.D. . . . LINE OUT Relâcher le bouton de pause et reproduire encore.	Vérifier que la déformation est dans la plage donnée suivante. 1. Bande métale . . . sous 2% B. Special sous 4! c. Bande normale . . sous 2%	
	Si le facteur de la déformation excède les valeurs ci-dessus, vérifier le réglage du courant de la polarisation.		
Contrôle de réonse de fréquence	Insérer la bande METAL	VR703 (L-Ch) VR704 (R-Ch)	40Hz–125Hz . . . 5dB 125Hz–10Hz . . . 3dB 10KHz–15KHz . . . 5dB.
	Insérer la bande Cr02		
	Insérer la bande NORMAL		40Hz–125Hz . . . 5dB 125Hz–10KHz . . . 3dB 10KHz–14KHz . . . 5dB.

Repair Parts List / Reparaturteilliste / Liste des pièces de rechange

Schematic Location	Parts No.	Description
TRANSISTORS, DIODES AND IC'S		
Q101	302001112	2SK49 (F,H), FM RF Amp.
Q102, 104	301901133	LC1674 (K,L), FM MIX OSC
Q103	301901134	LC1675 (K,C), FM IF Amp.
Q201	301901134	LC1675 (K,C), MW OSC
Q202	301901134	LC1675 (K,C), LW OSC (MW/ LW/FM Only)
Q203, 204	301901134	LC1675 (K,C) IF Amp.
Q205	301201222	2SC2634 (S,T), Audio Amp.
Q301-303	301901132	LC945, for Switching, VOC Stop Control
Q304, 305	301201222	2SC2634 (S,T) Audio Amp.
Q501-504	301201202	2SC1571, Flat Amp.
Q601, 602	301001145	2SA921 (S,T) Differential Amp.
Q603, 604	301201155	2SC1318 (R,S) Pre-Driver
Q605, 606	301301134	2SD571 (K,L) Idling
Q607, 608	301201132	2SC1384 (R,S) Driver
Q609, 610	301001140	2SA684 (R,S) Driver
Q611-614	301201169	2SC1826 (O,Y) Power Amp.
Q701-706	301201222	2SC2634NC (S,T), MIC/REC Amp.
Q901	301201223	2SC2590 OSC
Q902	301201169	2SC1826 (Y,C) Stabilizer
Q903, 904	301901132	LC945 (P,K), For Auto-Stop
D102-103	300111018	1S1588, For Switching Rectifier
D104, 105	300111008	1K188, FM AGC Detector
D201-203	300111018	1S1588, AM AGC, POP Pro. Rectifier
D204-206	300111008	1K188, AM AGC POP Pro. Rectifier
D601	300919026	1N4003 DC Balance Regulator
D701, 702	300111018	1S1588, Reversal Prevention
D801-813	300414042	LN224RP, REC Level Ind. (RED LED)
D802-814	300414040	LN324GP, LED Speed Control (GREEN LED)
D815	300313074	UZ12B, Stabilizer
D901	300919026	1N4003, Rectifier
D902	300515003	2P05M, Auto-Stop Control
D903, 904	300919011	W-02, Rectifier
D1001, 1002	300111008	1K188, Detector
D1201	300919027	KBP-02, Rectifier
D1401-1506	300414042	LN224RP, Signal Ind.
IC101	303452251	HA-11225, IF Amp.
IC301	303452250	HA-12003, MPX Decoder
IC401, 402	303452164	uPC1024H, Phono Amp.
IC701, 702	303452218	NE646B, REC/PB Amp.
IC801, 802	303452279	TA7654P, REC Lever Driver
IC803, 804	303452152	NJM4558DD, LED Driver
IC1001	303452232	LB-1416, AF Power Ind. Driver
IC1101	303452188	LB-1405, Tuning Signal Ind. Driver

Schematic Location	Parts No.	Description
COILS AND VARIABLE PESISTROS		
L001	222301224	AM ANT Coil (AM/FM)
	222301225	MW/LW ANT Coil (MW/LW/FM)
L101	226501131	FM ANT COIL
L102-104	226501132	FM RF Coil
L105	226501152	2.2uH, FM IF Trap Coil
L106	226501161	FM OSC Coil
L107	225501131	FM IFT
L108	226501125	18uH, Moving Phase
L109	225501139	FM IFT Quadrature Detector
L201	223301127	MW OSC
L202	226501142	2mH, LW Filter (MW/LW/FM Only)
L203	223301129	LW OSC (MW/LW/FM Only)
L204	225301131	AM IFT 1st.
L205	225301132	AM IFT 2nd.
L206	225301133	AM IFT 3rd.
L701, 702	228641174	85KHz, Trap Coil.
L703-706	228641173	10mH, Peaking Coil
L707, 708	228641186	12mH Peaking Coil
L709, 710	228641189	Filter
L901	228641190	OSC
VR101	510502199	20KB, Muting Adj.
VR102	510502196	100KB, FM Singal Ind. Adj.
VR201	510502196	100KB, AM Signal Ind. Adj.
VR301	510502195	10KB, Voc Adj.
VR302	510502195	10KB, Separation Adj.
VR501	515121131	250KW, Balance Control
VR502	525121146	100KBx2, Volume Control
VR503, 504	525101179	50KBx2, Treble Bass Control
VR601, 602	510502201	200KB, Center Voltage Adj.
VR603, 604	510502198	1KB, Bias Adj.
VR701	525101184	50KAx2, REC Level Control
VR702, 703	510502200	50KB, Bias Adj.
VR704, 705	510502200	50KB, PB Lever Adj.
VR706, 707	510502199	20KB, REC Level Adj.
VR801, 802	510502147	10KB, REC Level Ind. Adj.

Schematic Location	Parts No.	Description
SWITCHES AND OTHERS		
S1	601011353	Switch Function Selector (AM/FM)
	601011354	Switch Function Selector (MW/LW/FM)
S2	614010171	Switch, Push 1-Key, Tape
S3	613000041	Switch, Slide, REC/PB
S4	614010171	Switch, Push 1-Key, Dolby NR
S5	601011356	Switch, Tape Selector
S6	615212287	Switch, Muting
S7	615212288	Switch, Pause
S8	615212286	Switch, Play
S9	615212262	Switch, Reed
S10	614010168	Switch, Power Supply (For UL, CSA)
	614010165	Switch, Power Supply (For BEAB.....)
S11	613000035	Switch, 6P, Slide
T001	201001543	Transformer, Power Supply (120 Only)
	2G7001543	Transformer, Power Supply (Multi Type) 
C1201	402220463	Smoothing Capacitor
F901	341220005	Fuse, 0.5A AC Circuit Protector (Long Size)
	345220005	Fuse, 500mA AC Circuit Protector (Mini Size)
	345250005	Fuse, 500mA AC Circuit Protector (Mini Size "S" "D" Mark)
F902	341220010	Fuse, 1A AC Circuit Protector (Long Size)
	345220010	Fuse, 1A AC Circuit Protector (Mini Size)
	345250010	Fuse, 1A AC Circuit Protector (Mini Size "S" "D" Mark)

THE ROTEL CO., LTD.
ROTEL ELECTRONICS CO., LTD.
ROTEL OF AMERICA, INC.
ROTEL HI FI LIMITED.

1-36-8 OHOKAYAMA, MEGURO-KU, TOKYO 152, JAPAN
2ND FLOOR, EVERGLORY BLDG., NO. 305, SECTION 3,
NANKING E. ROAD, TAIPEI, TAIWAN, REPUBLIC OF CHINA
13518 SO. NORMANDIE, GARDENA, CALIF. 90249, U.S.A.
2-4 ERICA ROAD, STACEY BUSHES, MILTON KEYNES,
BUCKINGHAMSHIRE, ENGLAND