

ROTEL®

Technical Manual

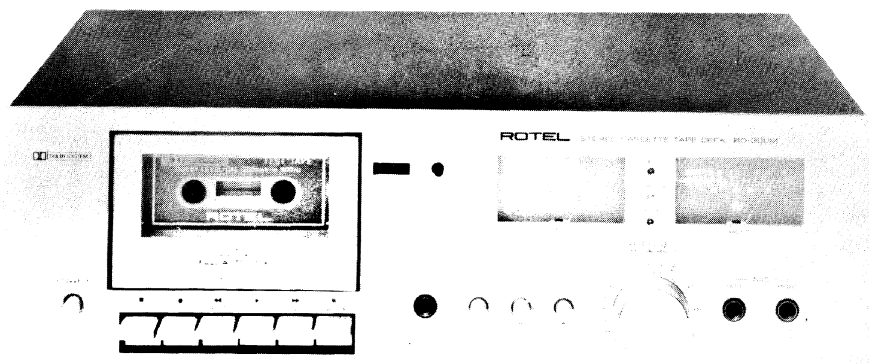

**METAL CAPABILITY
STEREO CASSETTE DECK**

RD-300M

TABLE OF CONTENTS

Chassis Layout	2	Wiring Diagram	13
Playback System Adjustments	4	Repair Parts List	16
Recording System Adjustments	6	Disassembly Diagram (1/2)	17
REC/PB System Adjustments	7	Disassembly Diagram (2/2)	21
Schematic Diagram	9		

INHALTSVERZICHMIS

Chassis-Anordnung	2	Drahtleitung Diagramm	13
Wiedergabepegels-Einstellung	4	Reparaturteilliste	16
Aufnahmesystems-Einstellung	6	Illustration des Auseinanderbaus (1/2)	17
Aufnahmesystems und Wiedergabepegels-Einstellung	8	Illustration des Auseinanderbaus (2/2)	21
Schaltungsschema	9		

TABLE DES MATLIERES

Installation du châssis	2	Diagramme de connexion	13
Réglages de système de la reproduction	5	Liste des pièces de rechange	16
Réglages de système de l'enregistrement	7	Schéma de démontage (1/2)	17
Réglages de système de l'enregistrement/reproduction	8	Schéma de démontage (2/2)	21
Diagramme de schématique	9		

-Chassis Layout/Chassis-Anordnung/Installation de

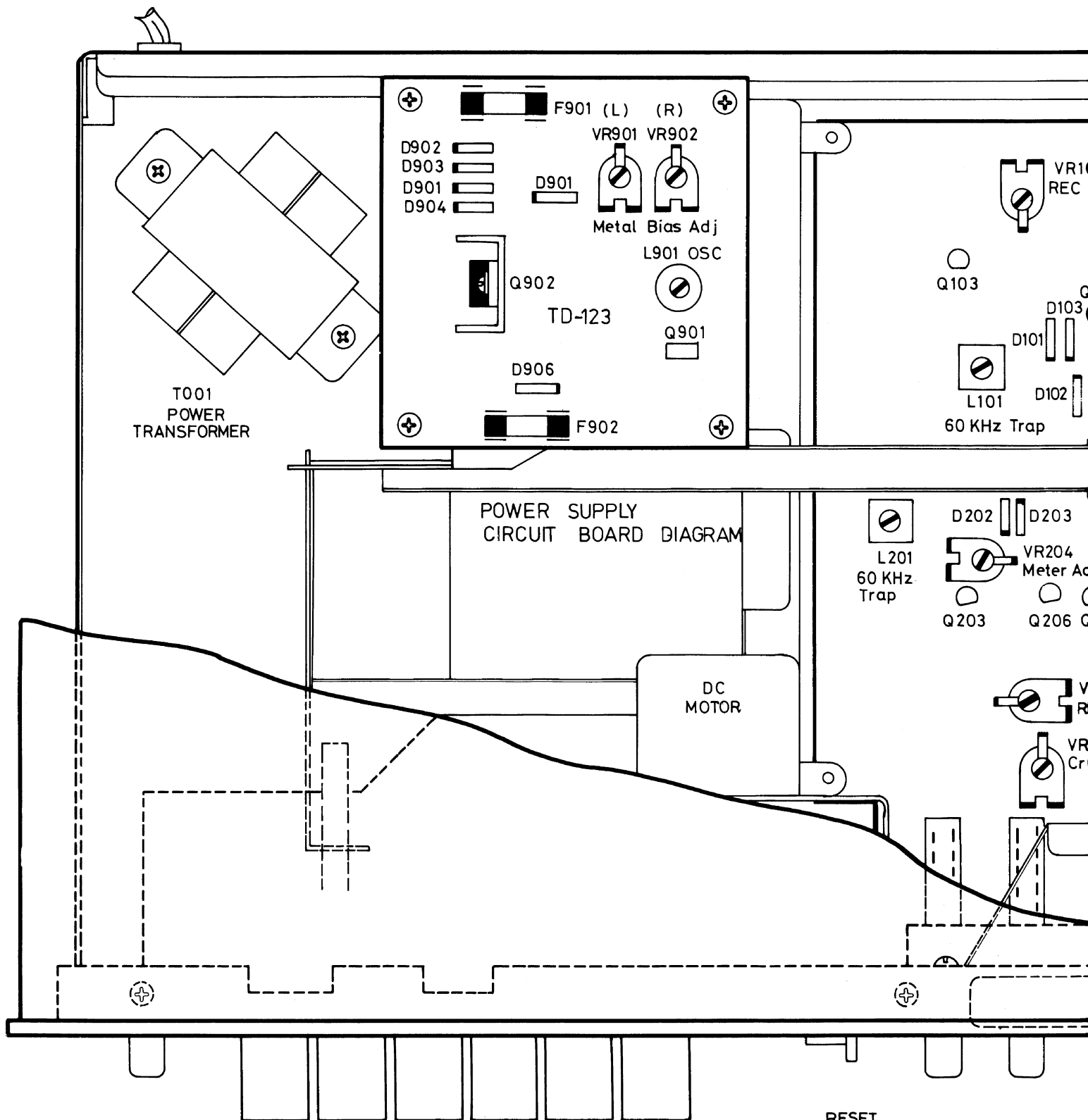

S5
POWER

■ ●
STOP/REJECT REC

◀▶
REW

▶▶
PLAY

▶▶▶
FFWD

||
PAUSE

S4
PHONES

S4
DOLBY NR

S3
BIAS

RESET

VU

ng/Installation de Châssis

OUT LINE IN

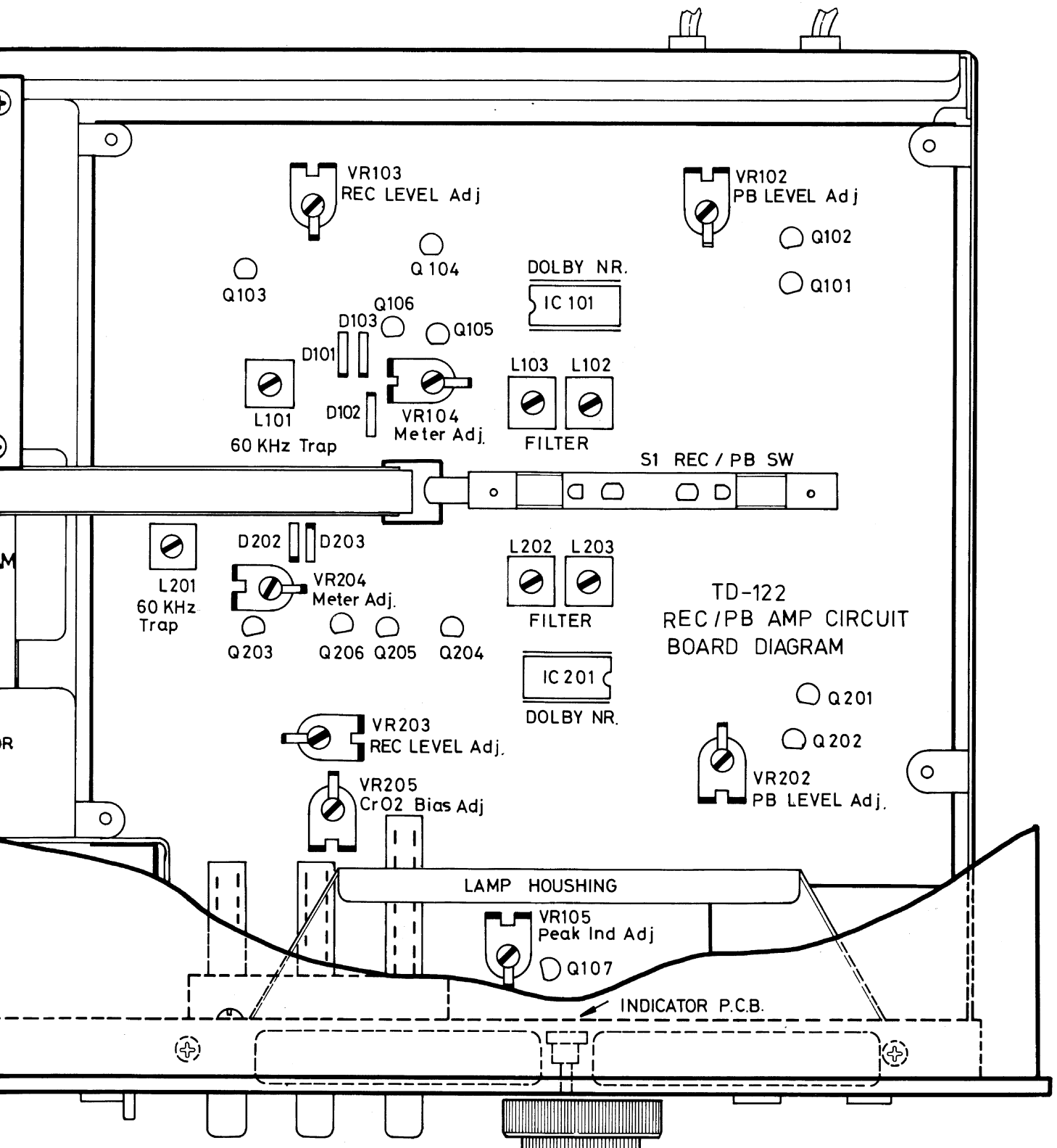

RESET M001 M002
 VU METER VU METER

S4 S3 S2 REC LEVER MIC
 PHONES DOLBY NR BIAS EQ L — ● — R LEFT RIGHT

Playback System Adjustments

Instruments: Oscilloscope, AC VTVM, Frequency Counter and Test Tape

Conditions: Oscilloscope, AC VTVM and Frequency Counter . . . LINE OUT Tape Selector . . . NORMAL Dolby NR . . . OFF

Adjustment Item	Test Tape	Adjust	Adjust for
Azimuth	LCT-3004-C	REC/PB head screw	Obtain largest wave form on Oscilloscope for both channels (Fig. 1)
Dolby Level	LCT-7001	VR102 (L-ch) VR202 (R-ch)	AC VTVM reads 580mV
Meter Calibration		VR104 (L-ch) VR204 (R-ch)	The needle on the Meter corresponds with the Dolby mark (Fig. 2)
Playback EQ Check	LCT-3009-C	Output Level difference between 40Hz, 1KHz and 10KHz signal is within $\pm 2.0\text{dB}$	
Tape Speed Deflection Check/Tape Speed Adjust	LCT-3001	Check that allowable margin of deflection at middle of or at the end of winding is in the range of +2%–1% (at 3000Hz allowable margin of deflection of speed is 3060-2970) If Tape Speed deflection surpasses the above range adjust speed of Motor (Fig. 3)	

Wiedergabepegels-Einstellung

Instrumente: Oszillograph, Wechselspannungsvoltmeter, Frequenz-Zähler und Test-cassette

Bedienung: Oszillograph, Wechselspannungsvoltmeter und Frequenz-Zähler . . . LINE OUT, Bank-Wähler . . . NORMAL
Dolby NR Taste . . . OFF

Einstellungsteil	Test-Cassette	Einstellung	Einstellungszweck
Azimet	LCT-3004-C	REC/PB Tonkopfschraube	Maximum-Wellenform auf Oszillograph für beiden Kanäle (Abb. 1) erhalten.
Dolby-Regel	LCT-7001	VR102 (L-K) VR202 (R-K)	Wechselspannungsvoltmeter auf 580mV einstellen.
Zähler-Meters		VR104 (L-K) VR204 (R-K)	Die Nadel des VU-Meters auf dem Dolby-Zeichen steht. (Abb. 2)
Prüfung der Wiedergabe "EQ"	LCT-3009-C	Ausgangspegelunterschied zwischen 40Hz, 1KHz und 10KHz darf innerhalb + 2.0dB betragen.	
Überprüfung der Bandgeschwindigkeit /Einstellung der Bandgeschwindigkeitsabweichung	LCT-3001	Prüfen, ob Abweichung von der Sollgeschwindigkeit im Bereich + 2% - 1% liegt (bei 3000 Hz zwischen 3060-2970 Hz). Bei grösser Abweichung Motorgeschwindigkeit nachstellen (Abb. 3)	

Réglages de système de la reproduction

Instruments: Oscilloscope, Voltmètre électronique à courant alternatif, Analyseur de fréquence et bande d'essai.

Conditions: Oscilloscope, Voltmètre électronique à courant alternatif et analyseur de fréquence LINE OUT
 sélecteur de bande NORMAL Dolby NR OFF

Item de réglage	Bande d'essai	Régler	Régler pour
Azimuth	LCT-3004-C	Vis de tête de Enregistrement/reproduction	Obtenir forme d'onde la plus grande sur l'oscilloscope pour les deux canaux (fig. 1)
Niveau de Dolby	LCT-7001	VR 102 (canal gauche) VR 202 (canal droit)	Le voltmètre électronique à courant alternatif lit 580 mV.
Calibrage de mètre		VR 104 (canal gauche) VR 204 (canal droit)	L'aiguille sur le mètre correspond à la marque Dolby (fig. 2)
Contrôle de l'égalisation de reproduction	LCT-3009-C	Différence de niveau de sortie entre les signaux 40 Hz, 1 KHz et 10KHz est dans ± 2.0 dB.	
Contrôle de la Variation de la vitesse de bande/réglage de la vitesse	LCT-3001	Vérifier que la marge admissible de variation au milieu ou à la fin de bobinage est dans la plage donnée de +2%–1%(à 3000 Hz marge admissible de variation de la vitesse est 3060-2970). Si la variation de vitesse de bande surpasse la plage donnée ci-dessus, régler la vitesse de moteur. (fig. 3)	

FRONT CHASSIS VIEW

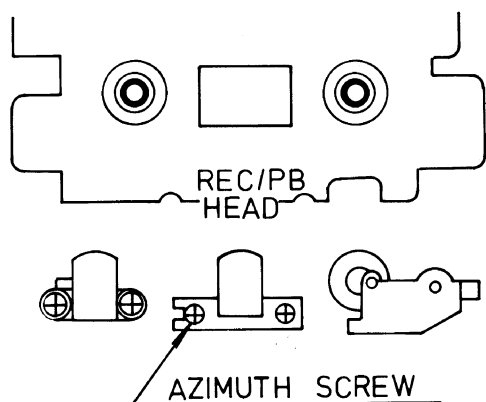

ADJUST AZIMUTH SCREW TO OBTAIN MAXIMUM DEFLECTION ON SCOPE

Fig. 1 Azimuth Adjustment
 Abb. 1 Azimuteinstellung
 Fig. 1 Réglage de l'azimut

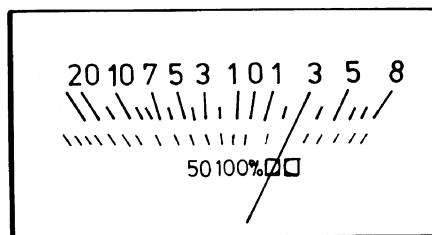

ADJUST POTENTIOMETER VR104 (VR204 FOR R-CH) SO THAT VU METER NEEDLE INDICATES DOLBY MARK.

Fig.2 Dolby Level Adjustment
 Abb. 2 Einstellung der Dolby-Regel.
 Fig. 2 Réglage du niveau Dolby

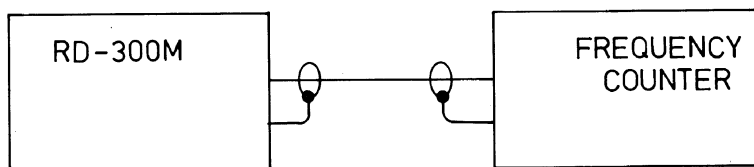
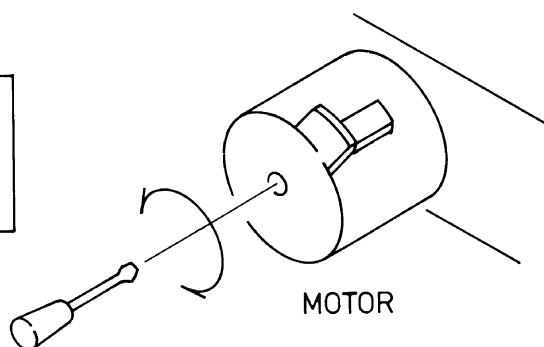

Fig. 3 Tape speed Adjustment
 Abb. 3 Einstellung der Bandgeschwindigkeitabweichung
 Fig. 3 Réglage de la vitesse de défilement de la bande



Recording System Adjustments

Instruments: Oscilloscope, Signal Generator, AC VTVM and Blank Tape

Conditions: Dolby NR ... OFF REC Level ... Maximum

Adjustment Item	Coupling	Tape Selector	Adjust	Adjust for
Bias Carrier	Oscilloscope ... Point P1 (P2 R-ch)	METAL	L101 (L-ch) L201 (R-ch)	Obtain Min. deflection on the Oscilloscope
19KHz Filter	S.G. (400Hz 0dB) ... LINE IN/LINE OUT ... 410mV Changed S.G. to 19KHz Dolby NR ... ON	NORMAL	L102, 103 (L-ch) L202, 203 (R-ch)	AC VTVM reads -30dB (Minimum)
Bias Voltage	Oscilloscope ... Point 11 (12 R-ch)	METAL	VR901 (L-ch) VR902 (R-ch)	AC VTVM reads 6mV
		CrO2	VR205	AC VTVM reads 4.5mV
		NORMAL		AC VTVM reads 3mV
Peak Indicator	S.G. (400Hz 0dB) ... LINE IN/LINE OUT ... 410mV Increase signal level to 8dB	NORMAL	VR105	Peak Indicator lights up.

Aufnahmesystems-Einstellung

Instrumente: Oszillograph, NF-Generator, Wechselspannungsvoltmeter und Leercassette.

Bedienungen: Dolby NR Taste ... OFF Aufnahmepegelregler ... Maximum

Einstellungsteil	Kupplung	Band-Wähler	Einstellung	Einstellungszweck
Bias-Trägerstrom	Oszillograph ... Punkt P1 (P2 R-K)	METAL	L101 (L-K) L201 (R-K)	Min. Abweichung auf Oszillograph erhalten.
19KHz Filter	NF-Generator (400Hz 0dB) ... an "LINE IN/LINE OUT" ... 410mV NF-Generator auf 19 KHz. Dolby NR ... ON	NORMAL	L102, 103 (L-K) L202, 203 (R-K)	Wechselspannungsvoltmeter auf -30dB einstellen, (Minimum)
Vorspannung	Oszillograph ... Punkt 11 (12R-K)	METAL	VR901 (L-K) VR902 (R-K)	Wechselspannungsvoltmeter auf 6mV einstellen.
		CrO2	VR205	Wechselspannungsvoltmeter auf 4.5mV einstellen.
		NORMAL		Wechselspannungsvoltmeter auf 3mV einstellen.
Spitzenpegelanzeige	NF-Generator (400Hz 0dB) ... LINE IN/LINE OUT ... 410mV Nutzlaufstärke auf 8 dB zunehmen	NORMAL	VR105	Höhepunkt des Indikators leuchte

Réglages de système de l'enregistrement

Instruments: Oscilloscope, Générateur de signal, voltmètre électronique à courant alternatif et bande vierge

Conditions: Dolby NR ... OFF Niveau de l'enregistrement ... maximum

Item de réglage	Accouplement	Selecteur de bande	Régler	Régler pour
Porte-Polarisation	Oscilloscope ... Point P3 (P4 canal droit)	METAL	L-101 (canal gauche) L-201 (canal droit)	Obtenir la variation min. sur l'oscilloscope
Filtre 19KHz	Générateur de signal (400Hz 0dB) ... LINE IN/LINE OUT ... 410mV Changé le générateur de signal à 19KHz Dolby NR ... ON	NORMAL	L102, 103 (canal gauche) L202, 203 (canal droit)	Voltmètre électronique à courant alternatif lit -30dB (minimum)
Voltage de polarisation	Oscilloscope ... Point 11 (12 Canal droit)	METAL	VR901 (canal gauche) VR902 (canal droit)	Voltmètre électronique à courant alternatif lit 6mV
		CrO2	VR205	Voltmètre électronique à courant alternatif lit 4.5mV.
		NORMAL		Voltmètre électronique à courant alternatif lit 3mV
Indicateur de crête.	Générateur de signal (400Hz 0dB) ... LINE IN/LINE OUT ... 410mV Augmenter le niveau de signal à 8 dB.	NORMAL	VR105	Indicateur de crête allume.

REC/PB System Adjustments

Instruments: Signal Generator, H.D. Analyzer and Blank Tape

Conditions: Dolby NR ... OFF REC Level ... Maximum PLAY, REC, PAUSE ON

Adjustment	Conditions	Adjust	Adjust for
REC/PB Output Level	S.G. (400Hz 0dB) ... LINE IN/LINE OUT ... 410mV Release Pause Button and playback it again.	VR103 (L-ch) VR203 (R-ch)	Recording and Playback level difference must be within ± 1 dB
Distortion Check	S.G. (400Hz 0dB) ... LINE IN/LINE OUT ... 410mV H.D.Analyzer ... LINE OUT Release Pause Button and playback it again.	Check that distortion is within following range. a. METAL Tape ... under 1.5% b. CrO2 Tape ... under 3% c. NORMAL Tape ... under 1.5%	
	If the distortion factor exceeds the above, recheck Bias Current Adjustment.		
Frequency Response Check	METAL Tape insert it	VR901 (L-ch) VR902 (R-ch)	40Hz-125Hz ... 5dB 125Hz-10KHz ... 3dB 10KHz-16KHz ... 5dB
	CrO2 Tape insert it	VR205	
	NORMAL Tape insert it		40Hz-125Hz ... 5dB 125Hz-10KHz ... 3dB 10KHz-14KHz ... 5dB

Aufnahmesystems- und Wiedergabepegels-Einstellung

Instrumente: NF-Generator, Klirrfaktormessbrücke und Leer-cassette
Bedienungen: Dolby NR OFF Aufnahmespiegel . . . Maximum
 PLAY, REC, PAUSE Taste ON

Einstellung	Bedienungen	Einstellen	Einstellungszweck
Aufnahme/ Wiedergabe Ausgangspegel	NF-Generator (400 Hz 0dB) . . . LINE IN/LINE OUT . . . 410mV. Pause-Taste freigeben und spielen es rück noch einmal.	VR 103 (L-K) VR 203 (R-K)	Die Differenz der Aufnahme und Wiedergabe-Ausgangspegel innerhalb einer Toleranz von ± 1 dB liegen müssen.
Prüfen des Klirrfaktors	NF-Generator (400 Hz 0dB) . . . LINE IN/LINE OUT . . . 410mV. Klirrfaktormessbrücke . . . LINE OUT Pause-Taste freigeben und spielen es rück noch einmal.	Prüfen, ob Klirrfaktor den folgenden Werten entspricht: a. METAL Band unter 1.5% b. CrO2 Band unter 3% c. NORMAL Band unter 1.5%	
	Wenn der Klirrfaktor die angegebenen Werte übersteigt, dann Vormagnetisierungstrom prüfen.		
Prüfen des Frequenzgangs	METAL Band einschieben	VR 901 (L-K) VR 902 (R-K)	40Hz–125Hz . . . 5dB 125Hz–10KHz . . . 3dB 10KHz–16KHz . . . 5dB
	CrO2 Band einschieben	VR 205	
	Normal Band einschieben		40Hz–125Hz . . . 5dB 125Hz–10KHz . . . 3dB 10KHz–14KHz . . . 5dB

Réglages de système de l'enregistrement/reproduction

Instruments: Générateur de signal, analyseur H.D., et bande vierge
Conditions: Dolby NR . . . OFF
 Niveau de l'enregistrement maximum Reproduction, enregistrement, pause ON

Réglage	Conditions	Régler	Régler pour
Niveau de la sortie de l'enre- gistrement/repro- duction	Générateur de signal (400 Hz 0dB) . . . LINE IN/LINE OUT . . . 410 mV Relâcher le bouton de pause et reproduire encore.	VR 103 (canal gauche) VR 203 (canal droit)	Différence de niveau de l'enregistrement et reproduction doit être dans ± 1 dB.
Contrôle de la déformations	Générateur de signal (400 Hz 0dB) . . . LINE IN/LINE OUT . . . 410 mV Analyseur H.D. . . . LINE OUT Relâcher le bouton de pause et reproduire encore.	Vérifier que la déformation est dans la plage donnée suivante. a. Bande métale sous 1.5% b. Bande CrO2 sous 3% c. Bande normale sous 1.5%	
	Si le facteur de la déformation excède les valeurs ci-dessus, vérifier le réglage du courant de la polarisation.		
Contrôle de réponse de fréquence	Insérer la bande METAL	VR 901 (canal gauche) VR 902 (canal droit)	40Hz–125Hz . . . 5dB 125Hz–10Hz . . . 3dB 10KHz–16KHz . . . 5dB.
	Insérer la bande CrO2	VR 205	
	Insérer la bande NORMAL		40Hz–125Hz . . . 5dB 125Hz–10KHz . . . 3dB 10KHz–14KHz . . . 5dB.

Schematic Diagram / Schaltungsschema / Dia

NOTE: PARTS AND CIRCUIT SUBJECT TO CHANGES FOR IMPROVEMENT WITHOUT PRIOR NOTICE

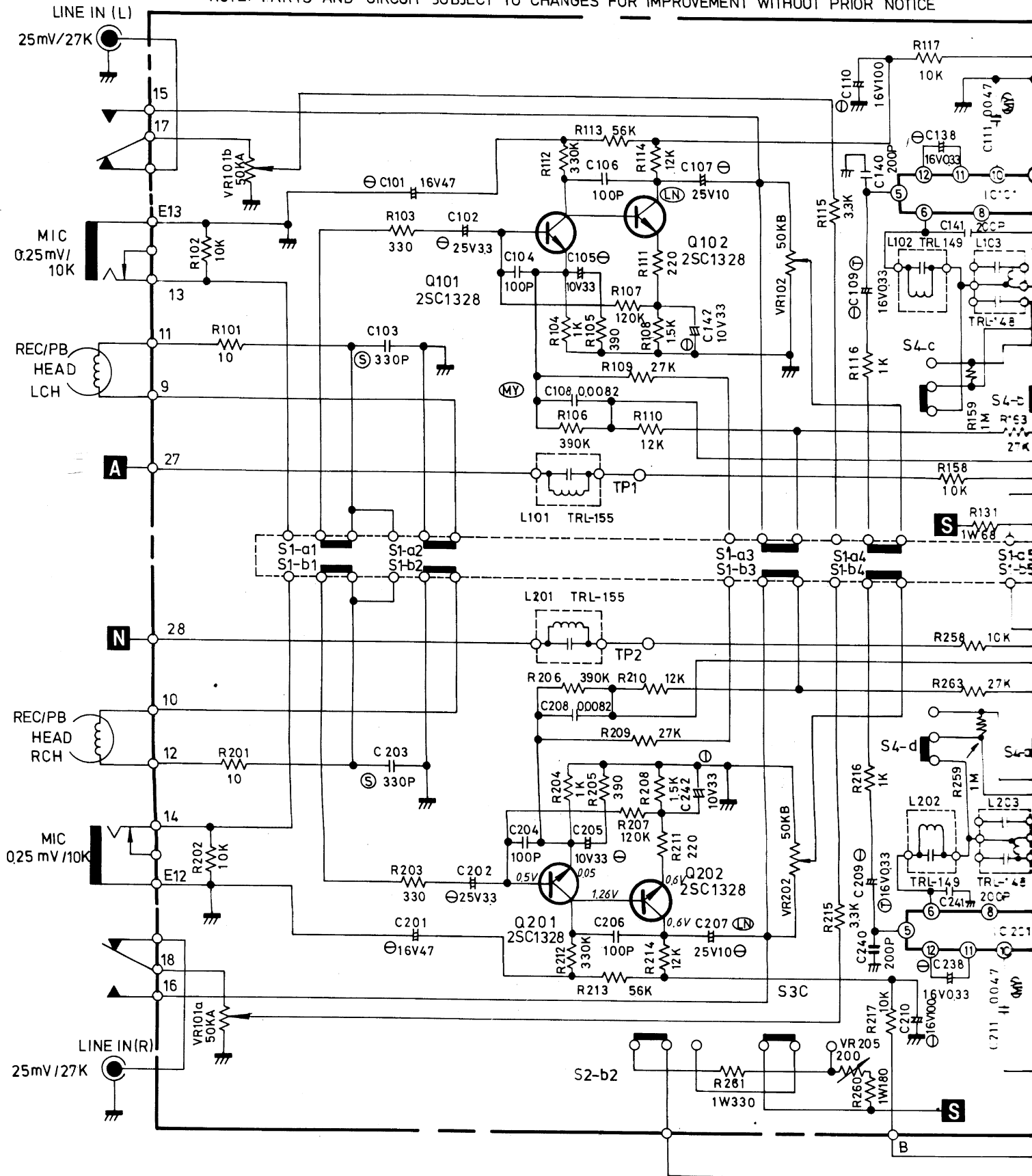

haltungsschema / Diagramme schématique

RESISTORS FOR IMPROVEMENT WITHOUT PRIOR NOTICE

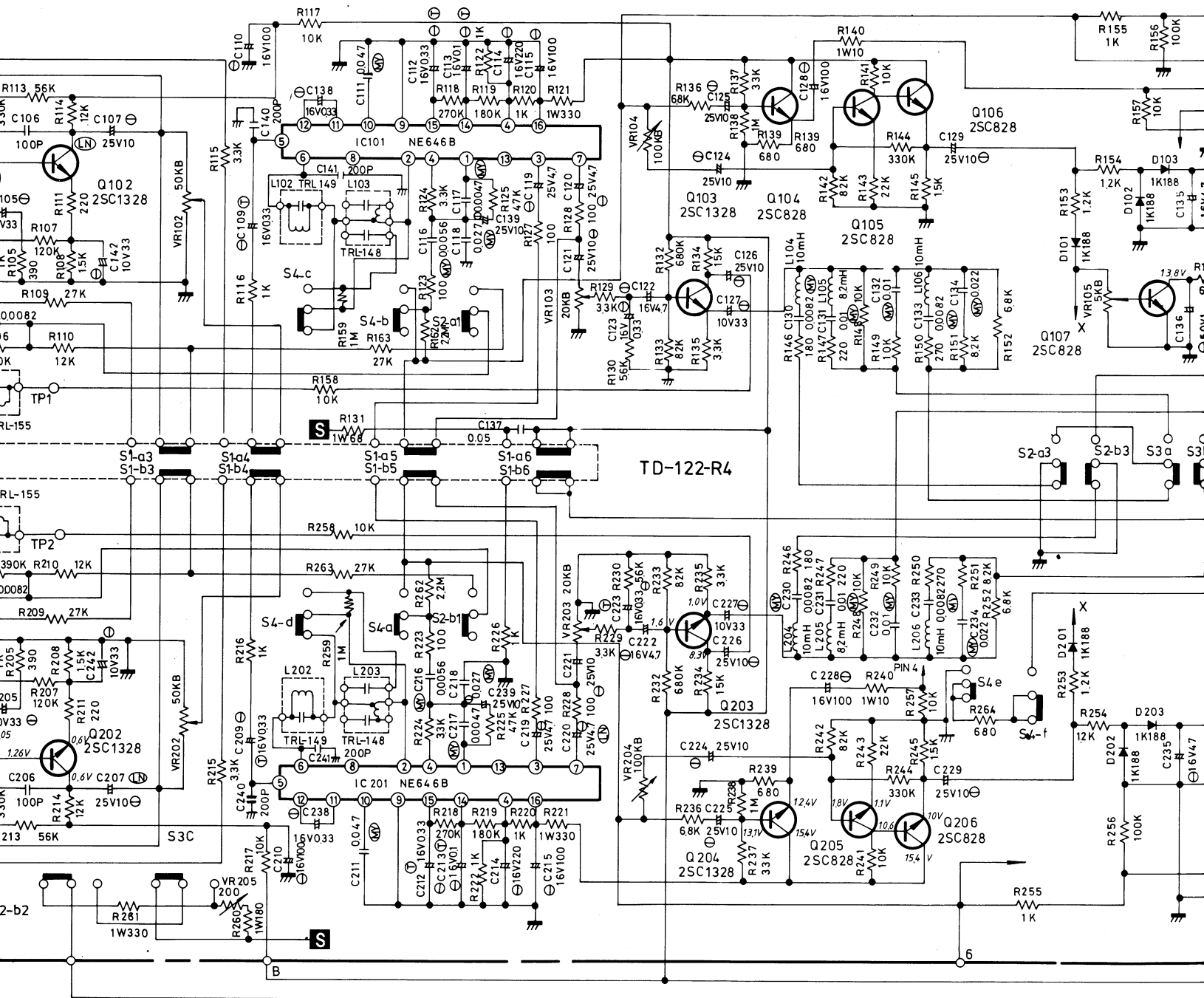

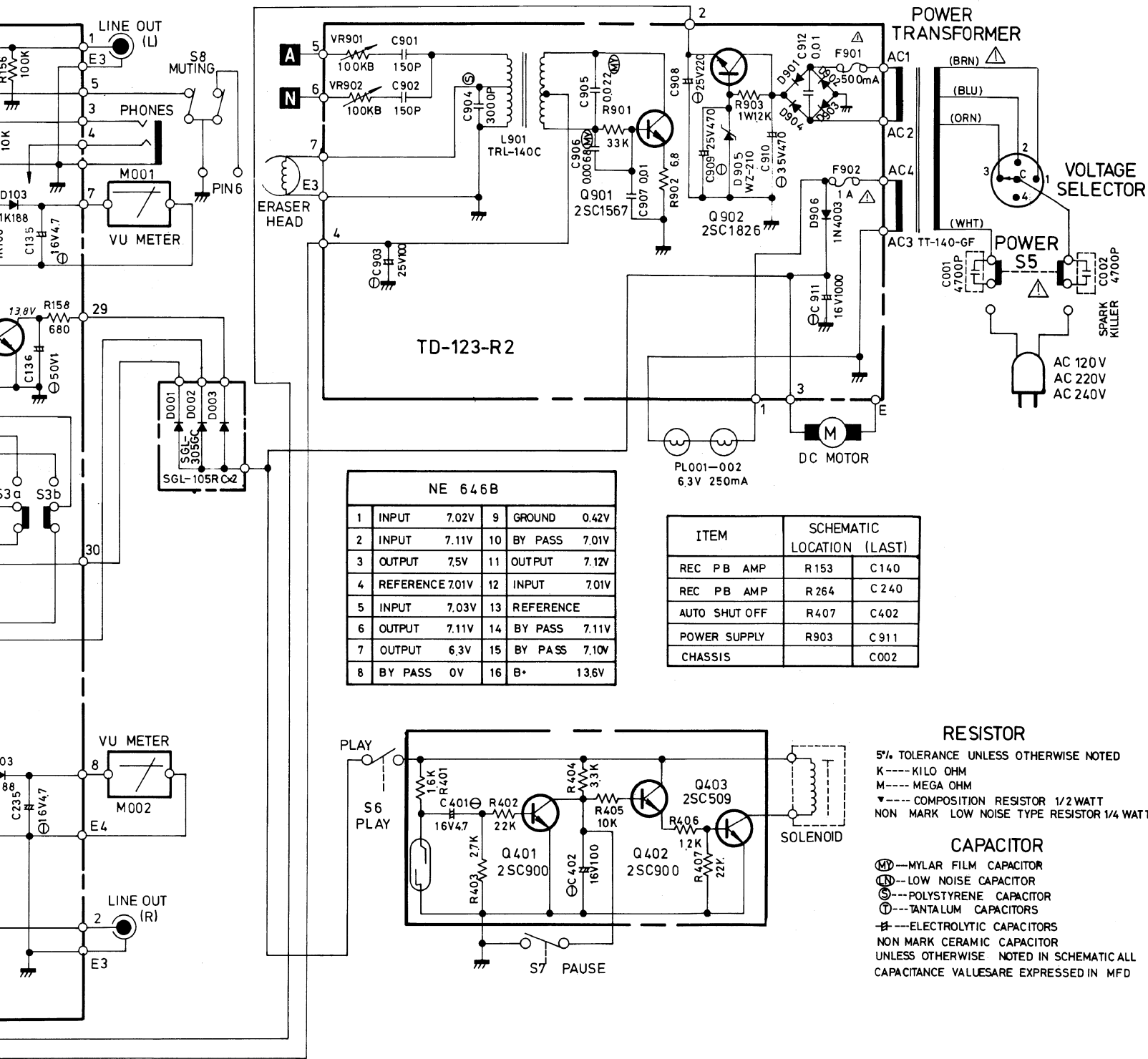

REC / PB AMP CIRCUIT BOARD DIAGRAM

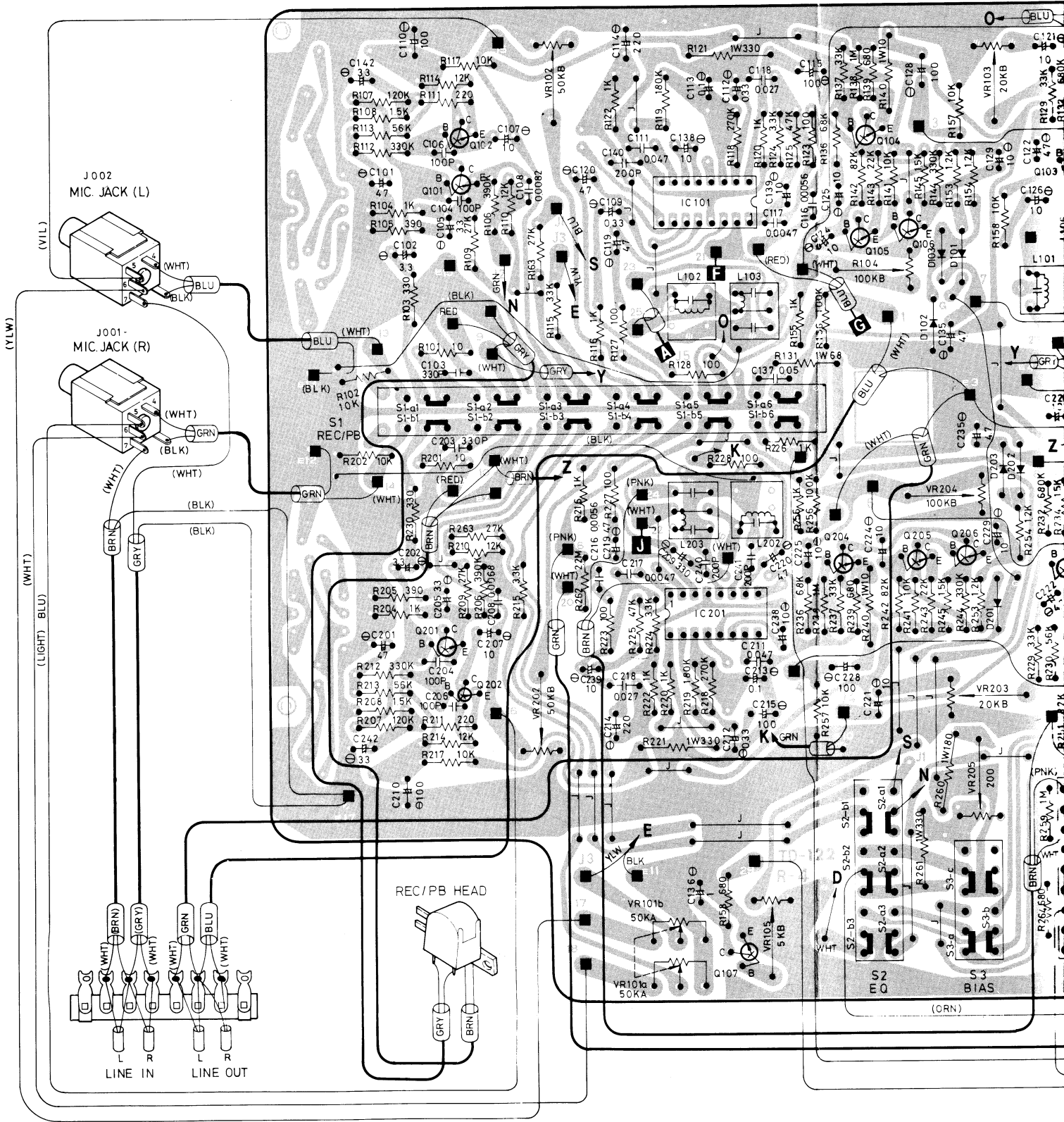

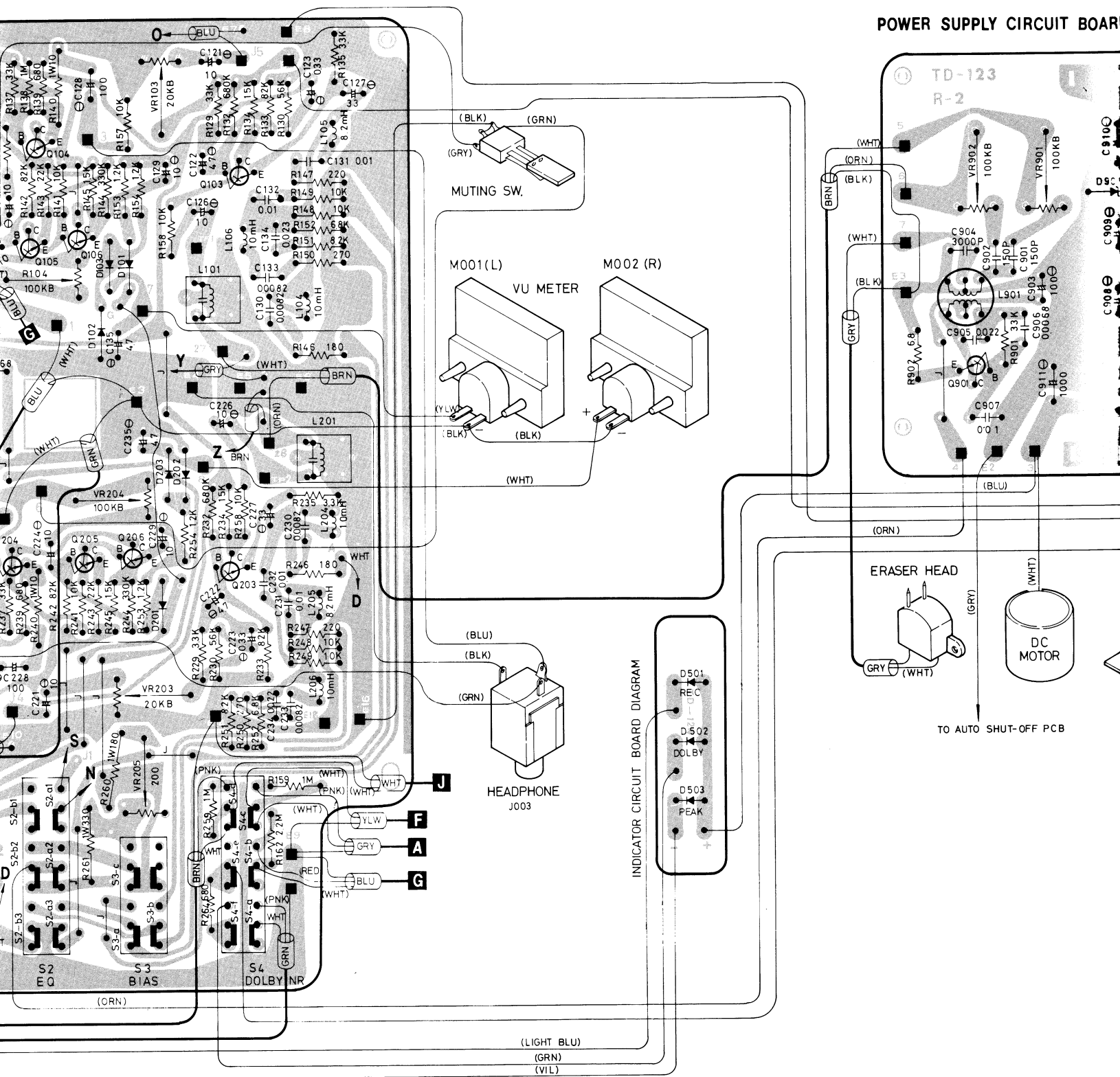

POWER SUPPLY CIRCUIT BOARD

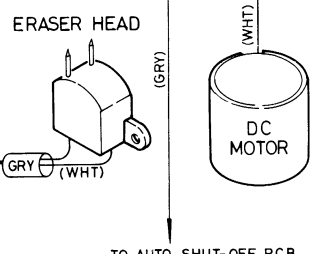
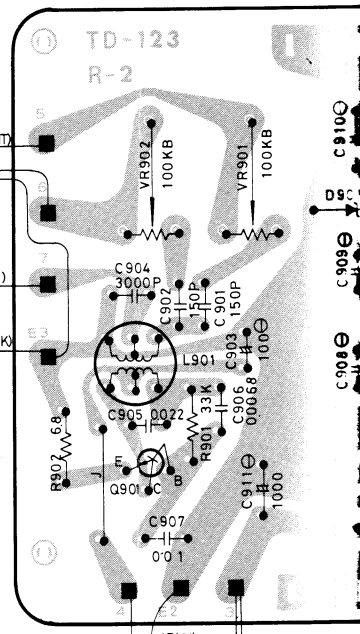

POWER SUPPLY CIRCUIT BOARD DIAGRAM

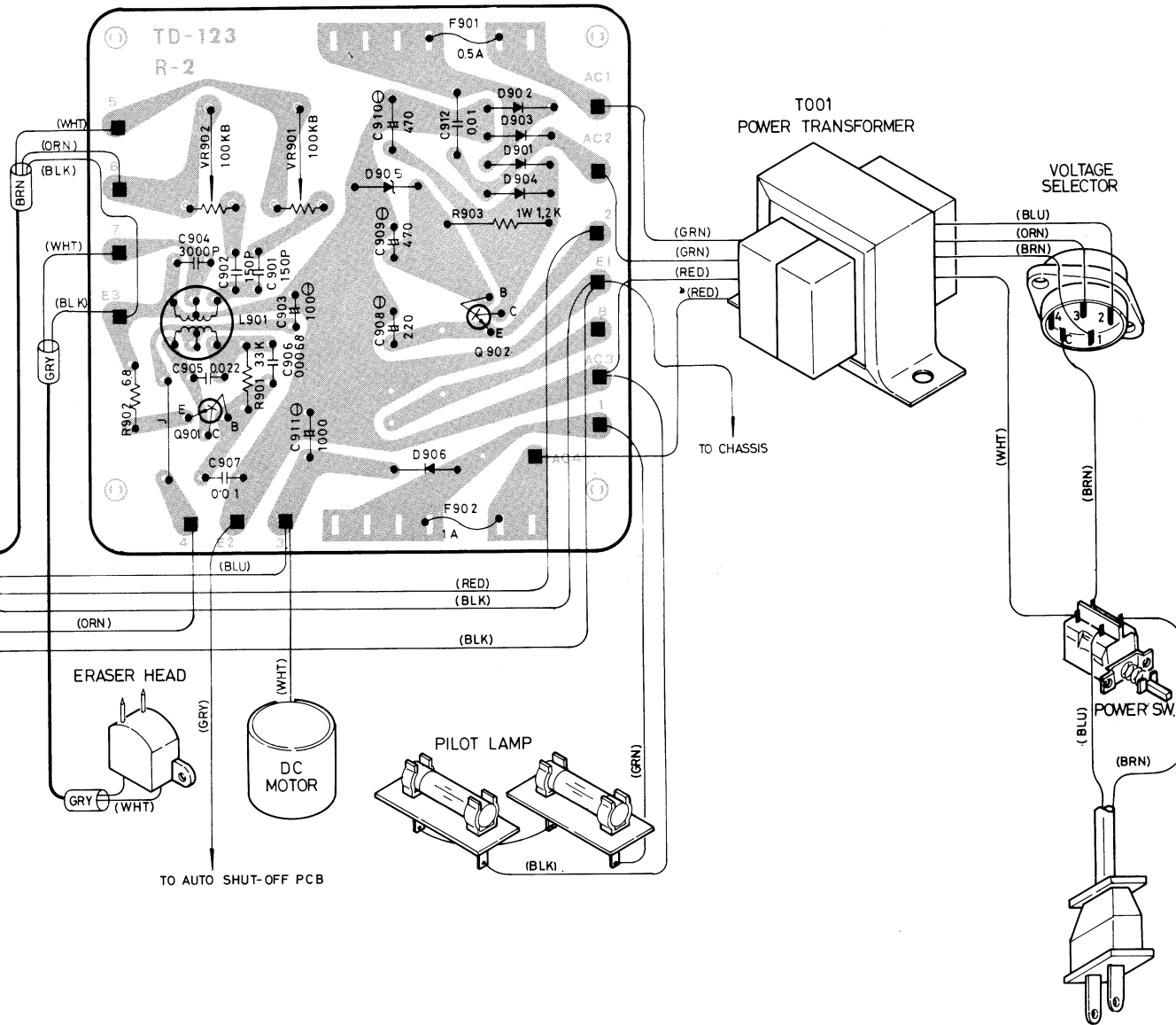



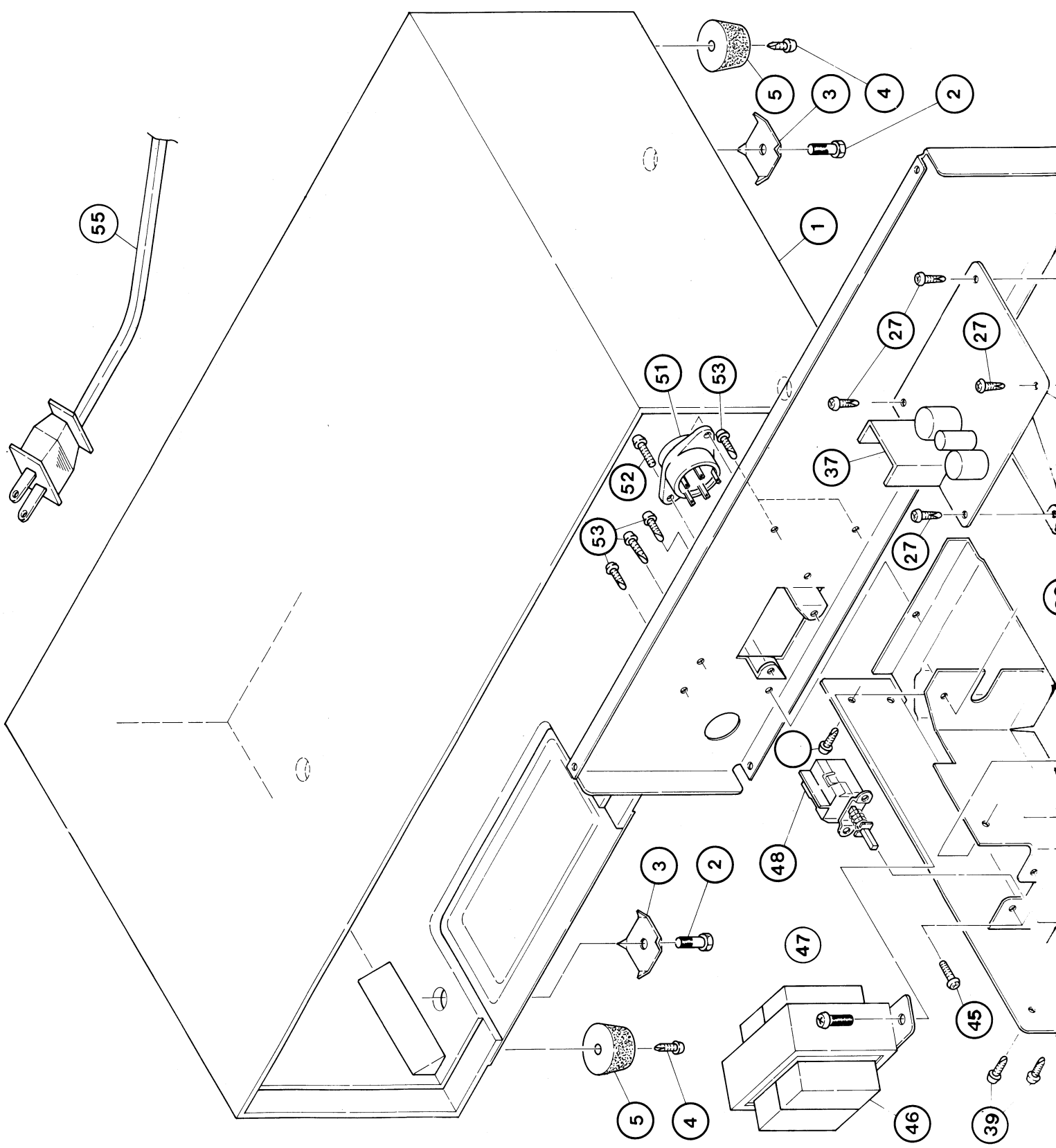

Repair Parts List/Reparaturteilliste/ Liste des pièces de rechange

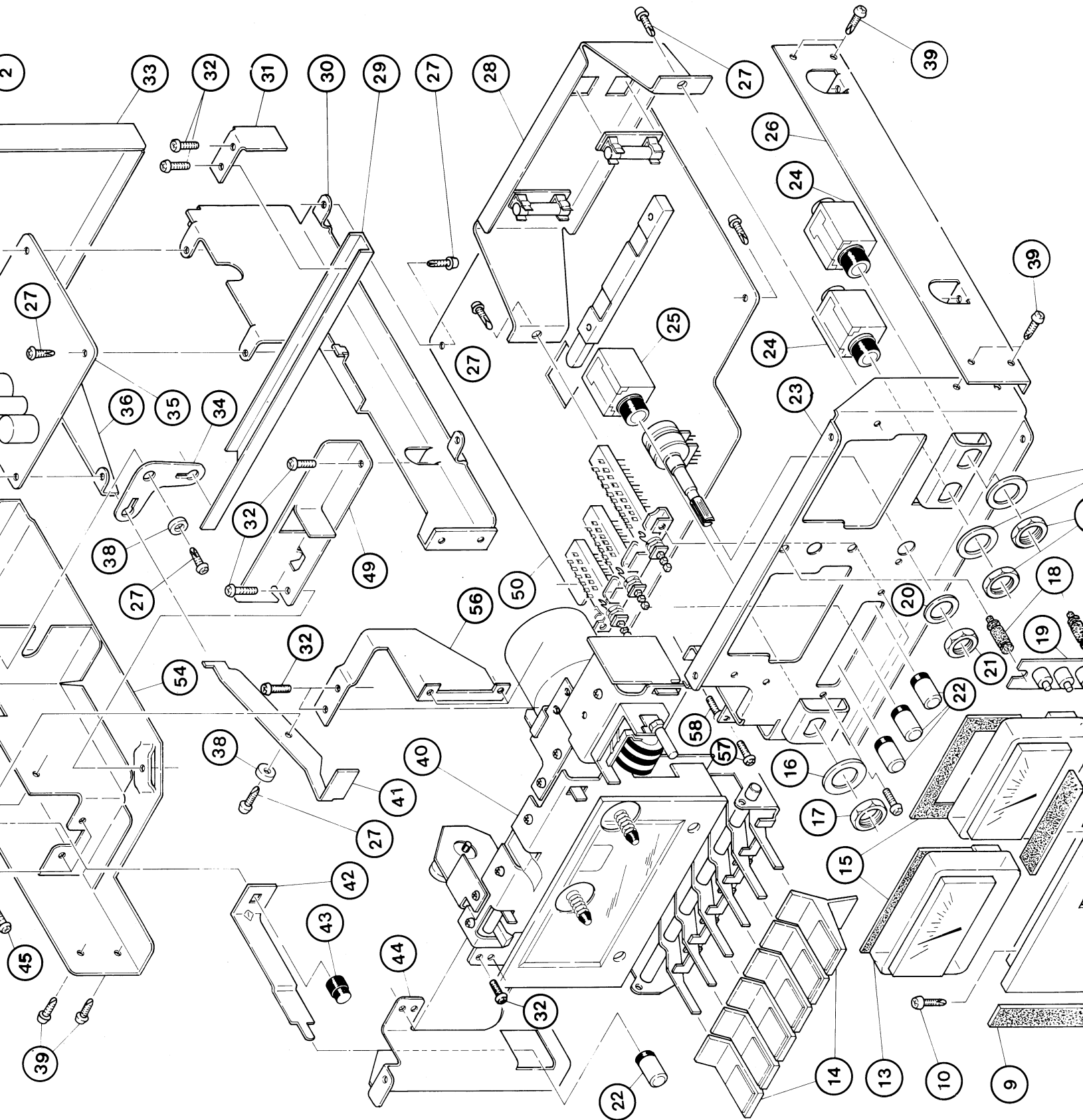
Schematic Location	Parts No.	Description
TRANSISTORS, DIODES AND IC'S		
Q101-103		
Q201-203	301201147	2SC1328 (S,T), MIC Amp.
Q104-107		
Q204-206	301201115	2SC2634 (R,S), Phone, Meter Amp.
Q901	301201150	2SC1567 (R,S), OSC
Q902	301201169	2SC1826 (O,Y), Stabilizer
D001,003	300414145	SEL-105RC, REC Peak Ind.
D002	300414015	SEL-305GC, Dolby NR Ind.
D101-103		
D201-203	300111008	1K188, Peak Meter Rectifier
D901-904	300919026	1N4003, Rectifier
D905	300313016	WZ-210, Zener Regulator 21V 1/2W
D906	300919026	1N4003, Rectifier
IC101,201	303452218	NE646B, REC/PB Amp.
COILS AND VARIABLE RESISTORS		
L101,201	228641174	85KHz Trap Coil
L102,202	228641170	Filter
L103,203	228641169	Filter
L104,106		
L204,206	228641173	10mH, Peaking Coil
L105,205	228641179	8.2mH, Peaking Coil
L901	228641168	OSC
VR101	525101158	50KAx2, REC Level Adj.
VR102,202	510502154	50KB, PB Level Adj.
VR103,203	510502165	20KB, REC Level Adj.
VR104,204	510502155	100KB, Meter Cal.
VR105	510502152	5KB, Peak Ind. Adj.
VR205	510502193	200, CrO2 Bias Adj.
VR901,902	510502155	100KB, Metal Bias Adj.
S1	613000031	Switch, Slide, REC/PB
S2,3,4(1 Set)	614030836	Switch, Push 3-Key, EQ, Bias and Dolby NR
S5	614010139	Switch, Power Supply (for UL, CSA)
	614010138	Switch, Power Supply (for BEAB) ⚠
F901	341221050	Fuse, 0.5A, AC Circuit Protector (Long Size)
	345222050	Fuse, 500mA, AC Circuit Protector (Mini Size)
	345252050	Fuse, 500mA, AC Circuit Protector (Mini Size "S" Mark) ⚠
F902	341221100	Fuse, 1A, Lamp Protector (Ling Size)
	345222100	Fuse, 1A, Lamp Protector (Mini Size)
	345252100	Fuse, 1A, Lamp Protector (Mini Size "S" Mark) ⚠

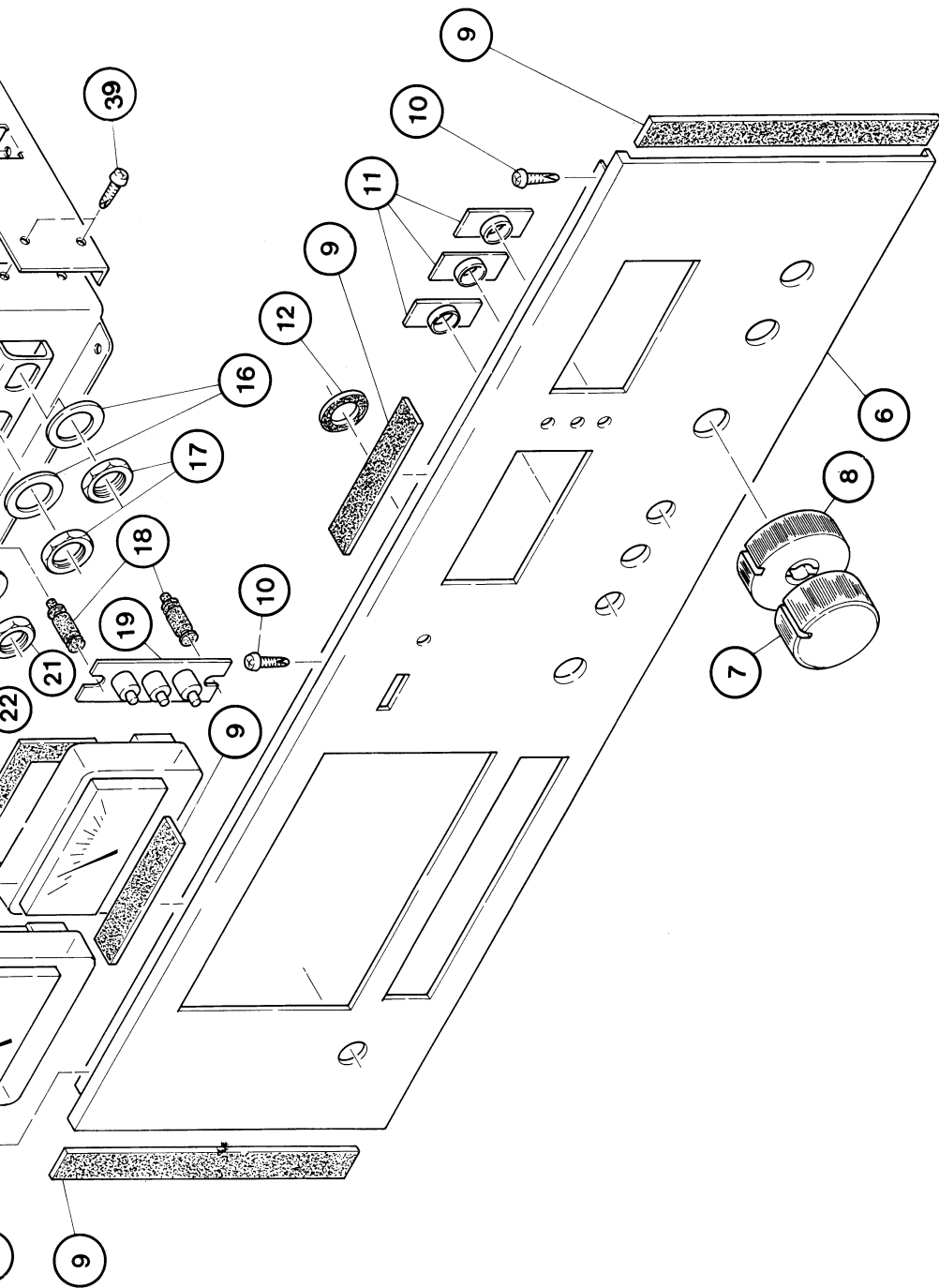





Key No.	Parts No.	Description	Key No.	Parts No.	Description
1	131011351	Cabinet (for BEAB)	51	648211190	Voltage Selector
	131011352	Cabinet	52	766223008	Screw, +M3x8 STV BK
2	703214015	Screw, +M4x15	53	726223006	Screw, +M3x6 BTV BK
3	761911139	Washer, Square	54	121011340	Chassis Body
4	730213010	Screw, +M3x10	55	796301115	Line Cord (UL, CSA)
5	673402020	Rubber Foot		796301149	Line Cord (for Europe)
6	111911500	Front Panel Ass'y		796301138	Line Cord (for BEAB) 
7	116310281	Knob, 33 [⁄] REC Level (L)		796301125	Line Cord (for Austria)
8	116310282	Knob, 36 [⁄] REC Level (R)	56	120012930	Support, Cassette Deck
9	990201332	Sponge, Front Panel	57	726213008	Screw, +M3x8 BTV MC
10	726203006	Screw, +M3x6 BTV MC			
11	672200855	Bush, Push Button			
12	990201334	Felt, Front Panel			
13	231310109	VU Meter			
14	116310279	Piano Key			
15		Cubson, Meter			
16	770500009	Washer, 12.5 [⁄]			
17	770402208	Nut, M11			
18	672200874	Support, Rubber			
19	141810944	Indicator PCB Ass'y			
20	770500006	Washer, 7.5 [⁄]			
21	770402205	Nut, M7			
22	116210048	Push Button			
23	122011407	Front Chassis (A)			
24	627117827	Jack, MIC			
25	626110035	Jack, Headphone			
26	120012890	Side Chassis (R)			
27	726203006	Screw, +M3x6 BTV			
28	128011300	Lamp Housing			
29	120012893	REC Lever (C)			
30	120012927	Support, PCB			
31	120012894	Spring, Flat			
32	766203006	Screw, +M3x6 STV MC			
33	123011522	Rear Chassis Ass'y			
	123011523	Rear Chassis Ass'y (for CSA)			
34	120012892	REC Lever (B)			
35	141811005	Power Supply PCB Ass'y (with Long Size Fuse)			
	141811006	Power Supply PCB Ass'y (with Mini Size Fuse)			
	141811007	Power Supply PCB Ass'y (with Mini S Mark Fuse)			
36	120012895	Sub-Support, PCB			
37	127012230	Heat Sinking			
38	770977239	REC Cylinder Bush			
39	722203008	Screw, +M3x8 JT20			
40	900111037	Cassette Deck Ass'y			
41	120012931	REC Lever (A)			
42	120012929	Lever, Power Switch			
43	114902311	Push Button, Plastic			
44	120012927	Front Chassis (B)			
45	703213006	Screw, +M3x6			
46	207001504	Transformer, Power Supply 			
47	713204006	Screw, +M4x6 W/SP W			
48	614010137	Switch, Power Supply (for UL, CSA)			
	610410138	Switch, Power Supply (for BEAB) 			
49	120012879	Support, Muting Switch			
50	141811004	REC/PB Amp. PCB Ass'y			

Disassembly Diagram/Illustration des Auseinanderba

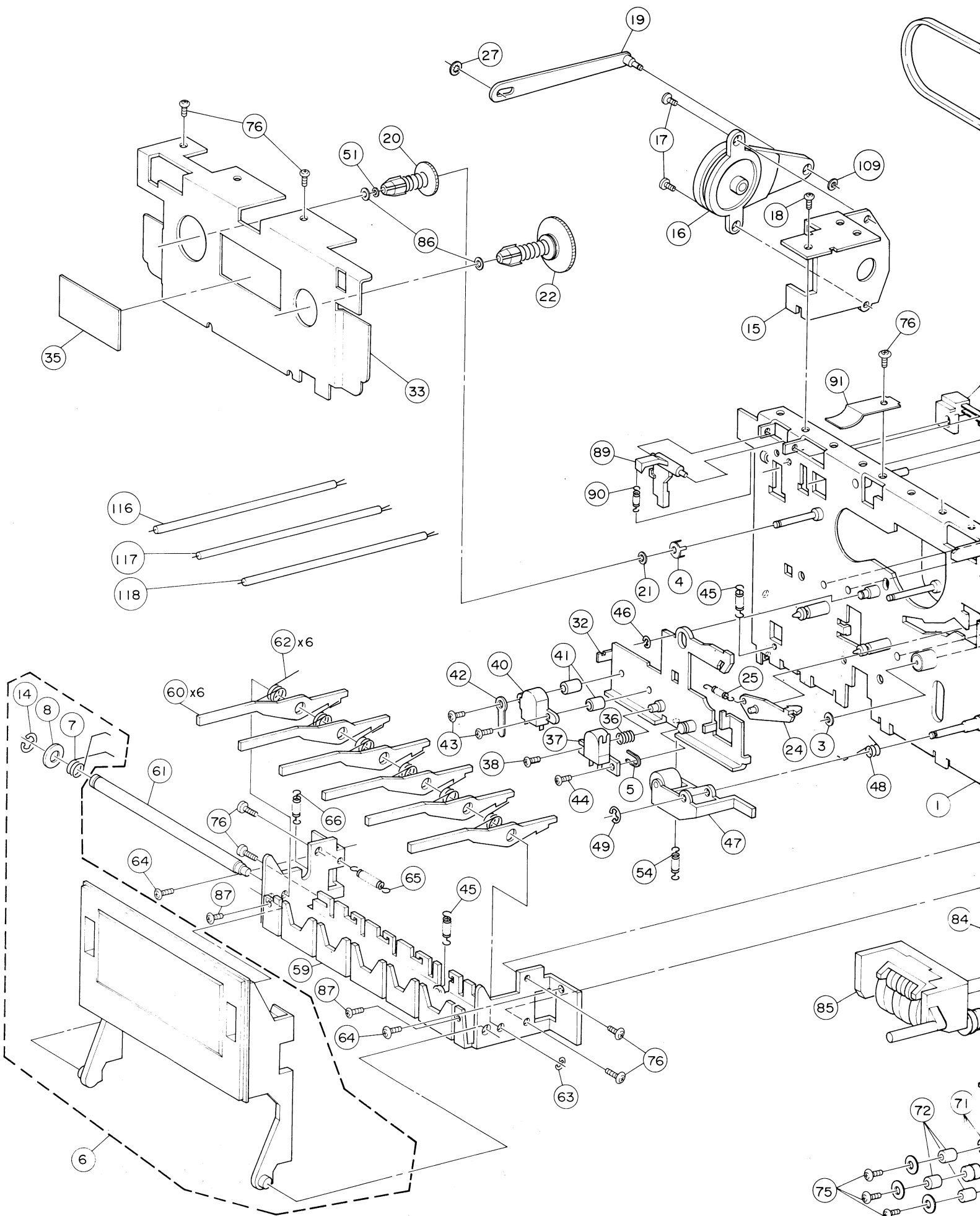

Naderbaus/ Schéma de démontage (2/2)

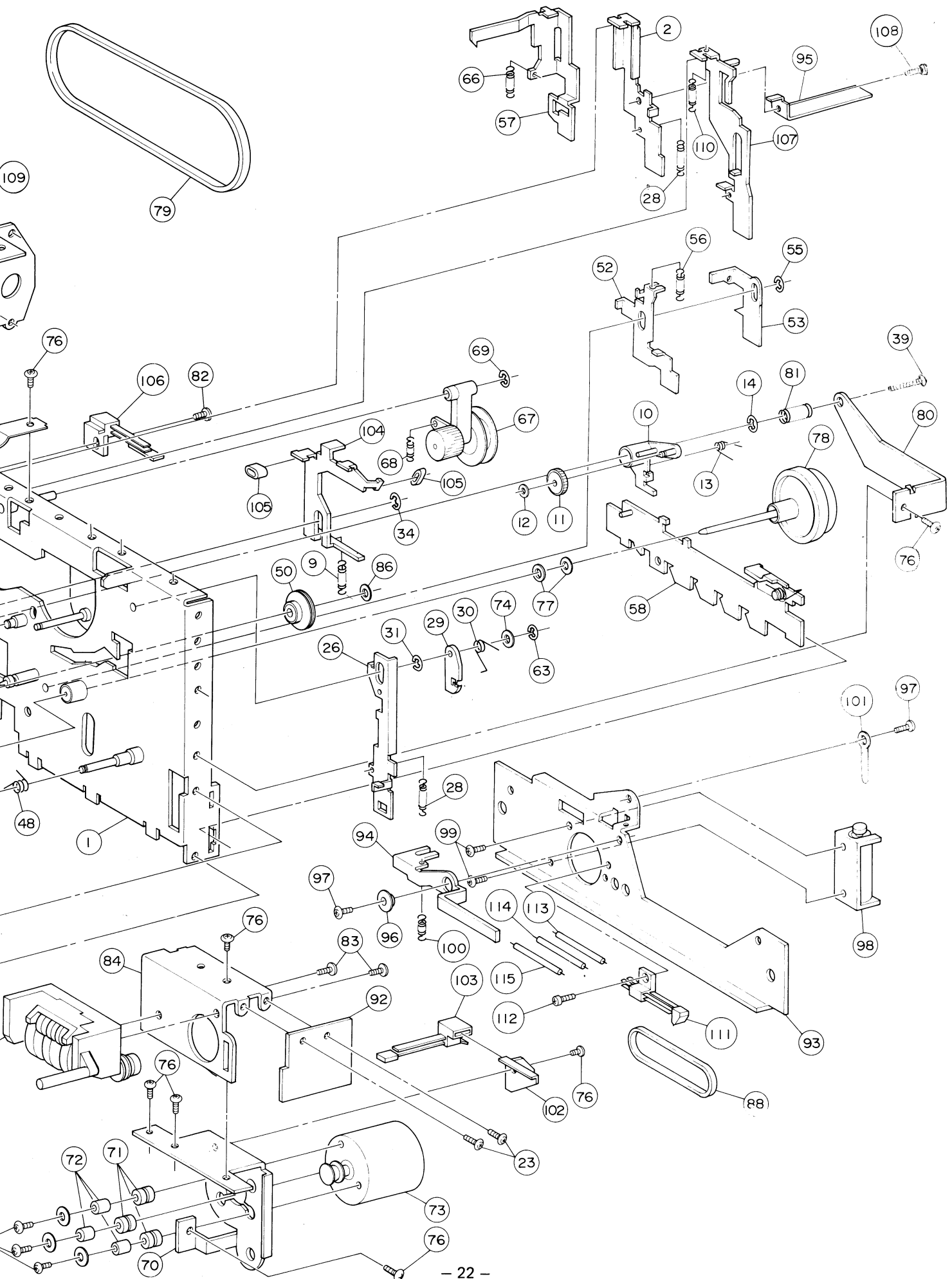

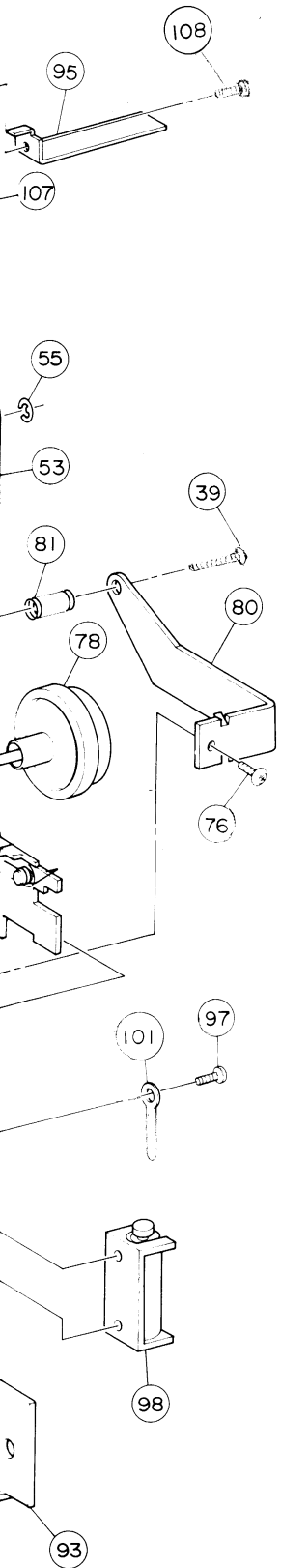

Key No.	Parts No.	Description	Key No.	Parts No.	Description
1	090211201	Ass'y, Chassis	60	090211216	Lever, Switch
2	090211230	Lever, Record (B)	61	090216417	Shaft, Button
3	090217514	Washer, Oil Shield	62	090216418	Spring, Button
4	090216442	Spring, Back Tension	63	770500039	E Ring, 3 ϕ
5	090217515	Spacer, HD	64	715202604	Screw, +M2.6x4 W/SP W
6	090211231	Ass'y, Cassette Door	65	090216419	Spring, Cam Plate
7	090216436	Spring, Cassette Door	66	090216420	Spring, Eject Lever
8	090217516	Washer, 5.5 ϕ x12 ϕ x0.8 ^t	67	090211217	Ass'y, Arm Pulley
9	090216431	Spring, Brake	68	090216421	Spring, REW Tension
10	090211204	Arm, Idler	69	770500027	E Ring, 2.5 ϕ
11	090216437	Gear, Middle	70	090211218	Holder, Motor (A)
12	770500046	E Ring, 1.6 ϕ	71	090216422	Cushion, Motor
13	090216404	Spring, FF. Tension	72	090217505	Ring, Motor
14	770500040	E Ring, 4 ϕ	73	090212203	Ass'y, DC Motor
15	090211239	Bracket, Damper	74	770500060	Washer, 3.3 ϕ x8 ϕ x0.5 ^t Flat Metal
16	090211224	Ass'y, Damper	75	090217517	Screw, +M2.6x8 W/SP W and F W
17	763202606	Screw, +M2.6x6 Tap Tite	76	763202604	Screw, +M2.6x4 Tap Tite
18	763202604	Screw, +M2.6x4 Tap Tite	77	770500080	Washer S.T.W. 2.1 ϕ x5 ϕ x0.25 ^t
19	090211232	Ass'y, Link Door	78	090216423	Flywheel and Capstan
20	090216407	Ass'y, Reel Supply	79	090216438	Belt, Drive
21	770500080	Washer, PS 2.1 ϕ x4 ϕ x0.25 ^t	80	090211219	Ass'y, Bracket Flywheel
22	090216408	Ass'y, Reel Take Up	81	090216432	Spring, Support Adjust
23	715203005	Screw, +M3x5 W/SP W	82	743203006	Screw, +M3x6 Tap Tite F-lock
24	090211229	Arm, Clutch	83	703203005	Screw, +M3x5 Pan Head
25	090216409	Spring, Play Clutch	84	090211233	Bracket, Counter
26	090211206	Ass'y, Lever Pause	85	090216439	Tape Counter
27	090217516	Stopper, Rod	86	092027604	Washer, Lock
28	090216410	Spring, Lever	87	723202608	Screw, +M2.6x8 Tpg.
29	090211207	Cam, Pause	88	090216433	Belt, Counter
30	090216411	Spring, Pause Cam	89	090211221	Arm, Record Sensor
31	770500027	E Ring, 2.5 ϕ	90	090216426	Spring, Record Senser Arm
32	090211208	Ass'y, Sub Chassis with Studs	91	090217518	Spring, Pack Clamp
33	090211226	Cover, Dust	92	090211234	Panel, Auto Shut Off
34	770500040	E Ring, 4 ϕ	93	090211235	Bracket, Chassis
35	090219001	Indicator, Tape	94	090211236	Lever, Auto Stop
36	090216413	Spring, Azimuth	95	090216401	Spring, REC Plate
37	090212201	REC/PB Head	96	090217526	Spacer
38	743202006	Screw, +M2x6 F-lock	97	763203006	Screw, +M3x6 Tap Tite
39	705202612	Screw, +M2.6x12 Bind	98	090212205	Ass'y, Coil Solenoid
40	090212204	Erase Head	99	713202004	Screw, +M2x4 W/SP W
41	090217502	Stud, Erase Head	100	092026555	Spring Pull
42	090217503	Clamp, Cord	101	090217503	Clamp, Cord
43	743202010	Screw, +M2x10 F-lock	102	090211237	Bracket, Pause Switch
44	705202004	Screw, +M2x4 Bind	103	092026520	Switch, Leaf
45	090216414	Spring, Panel	104	090211203	Arm, Brake
46	770500027	E Ring, 2.5 ϕ	105	090216402	Pad, Brake
47	090211210	Ass'y, Arm Pinch Roller	106	090216440	Switch, Leaf
48	090216415	Spring, Pinch Roller	107	090211205	Lever, REW
49	770500026	E Ring, 1.5 ϕ	108	713202604	Screw, +M2.6x4 W/SP W
50	090216416	Pulley, Drive	109	090217519	Washer, Lock E-2.6 ϕ
51	092027605	Washer, S.T.W. 2.1 ϕ x4 ϕ x0.13 ^t	110	090216441	Spring, Pull
52	090211211	Lever, FF.	111	092026519	Switch, Double Leaf
53	090211212	Lever, Play	112	715202006	Screw, +M2x6 W/SP W
54	090216416	Spring, Play Lever	113	090217520	C.W.V.
55	770500027	E Ring, 2.5 ϕ	114	090217521	C.W.V.
56	090216414	Spring, FF. Lever	115	090217522	C.W.V.
57	090211213	Lever, Eject	116	090217523	C.W. Shield (BRN)
58	090211214	Ass'y, Plate Cam	117	090217524	C.W. Shield (GRY)
59	090211215	Frame, Switch	118	090217525	C.W. Shield (BLK)

THE ROTEL CO., LTD.
ROTEL ELECTRONICS CO., LTD.
ROTEL OF AMERICA, INC.

1-36-8 OHOKAYAMA, MEGURO-KU, TOKYO 152, JAPAN

310 SEC. 5, NANKING E. ROAD, TAIPEI, TAIWAN

13518 SOUTH NORMANDIE AVENUE GARDENA,
CALIF. 90249. U. S. A.

Printed in Taiwan '80 Aug. 835201354