

ROTEL *hi-fi*

Technical Manual

RDP 980 Digital Audio Processor

SPECIFICATIONS : RDP 980 DIGITAL TO ANALOG CONVERTER

Frequency Response	5-20,000 Hz, \pm 0.5 dB
Signal to Noise Ratio	110 dB, IHF A
Total Harmonic Distortion	0.0025 % (1 kHz) @ 44.1 kHz
Intermodulation Distortion	0.006 % (400 Hz/ 7 kHz, 4:1 @ 0 dB)
Dynamic Range	95 dB
D to A Converter	64 x Oversampling $\Delta \Sigma$
Digital Filter	8 x Oversampling
TOSLINK Inputs	4 + 1 (Monitor)
Coaxial Inputs	4 + 1 (Monitor)
Coaxial Input Impedance	75 Ohms
TOSLINK Output	-17 dB @ 660 NM (IEC)
Coaxial Output	0.5 Volt P.P. @ 75 ohms
Audio Output	2.0 volts
Output Impedance	100 ohms
Power Consumption	15 watts
Power Requirements (AC)	120 volts 50/60 Hz or 220-230-240 volts 50/60 Hz
Weight	6.3 Kg / 13.86 Lbs.
Dimensions	440 mm x 72 mm x 316 mm (WxHxD) 17-3/8" x 2-7/8" x 12-7/16" (WxHxD)

All specifications are accurate at the time of printing. Rotel reserves the right to make improvements without notice.

Serial No.
Beginning

THE ROTEL CO., LTD.
ROTEL ELECTRONICS CO., LTD.

4TH FL. BUNZAN-SHINSEN BLDG., 10-10 SHINSEN-CHO,
SHIBUYA-KU, TOKYO 150 JAPAN.
3RD FL. ROTEL BLDG., NO. 35 FUSHING NORTH ROAD,
TAIPEI, TAIWAN, REPUBLIC OF CHINA.

SYMBOL	PARTS NO.	DESCRIPTION	
D701-D703	034 RD5.6JST1	ZENER DIODE	
D721	034 RD4.7JST1	ZENER DIODE	
D771-D774	034 RD16JST1	ZENER DIODE	
D801	034 1N4003-TB	DIODE	
D901-D914	034 1N4003-TB	DIODE	
D921-D924	034 1N4148-86	DIODE	
D925,D926	034 RD4.7JST1	ZENER DIODE	
F991	036 (U)F1A	FUSE US	△
	036 (S)T500mA	FUSE EUROPE UK	△
		FUSE AUSTRALIA	△
J73	054 MK2 560RFECZ	R. METAL 560R	
K101	066 GP1F32R	OPTICAL OUTPUT	
K102	066 4TR-2487#4	1P PIN JACK	
K103	066 GP1F32R	OPTICAL OUTPUT	
K104	066 4TR-2487#4	1P PIN JACK	
K105	066 GP1F32R	OPTICAL OUTPUT	
K106	066 4TR-2487#4	1P PIN JACK	
K107	066 GP1F32R	OPTICAL OUTPUT	
K108	066 4TR-2487#4	1P PIN JACK	
K109	066 GP1F32R	OPTICAL OUTPUT	
K110	066 4TR-2487#4	1P PIN JACK	
K111	066 GP1F32T	OPTICAL TARMINAL	
K112	066 4TR-2487#4	1P PIN JACK	
K201	066 4TR-2487#8	1P PIN JACK	
K202	066 4TR-2487#7	1P PIN JACK	
L124	022 T-1048NF-1	POWER TRANSFORMER	
L125	022 T-1049NF-1	POWER TRANSFORMER	
L301-L310	021 TRL-361	MICRO INDUCTOR 4.7UH	
L311	021 TC1027-04	OUTPUT TRANSFORMER	
L351,L352	021 TRL-361	MICRO INDUCTOR 4.7UH	
L401-L403	021 TRL-361	MICRO INDUCTOR 4.7UH	
L601,L602	021 TRL-361	MICRO INDUCTOR 4.7UH	
L611-L614	021 TRL-361	MICRO INDUCTOR 4.7UH	
R301	054 MK2 075RFECZ	R. METAL 75R	
R302	054 MK2 100KFECZ	R. METAL 100K	
R303	054 MK2 02K2FECZ	R. METAL 2.2K	
R304	054 MK2 075RFECZ	R. METAL 75R	
R305	054 MK2 100KFECZ	R. METAL 100K	
R306	054 MK2 02K2FECZ	R. METAL 2.2K	
R307	054 MK2 075RFECZ	R. METAL 75R	
R308	054 MK2 100KFECZ	R. METAL 100K	
R309	054 MK2 02K2FECZ	R. METAL 2.2K	
R310	054 MK2 075RFECZ	R. METAL 75R	
R311	054 MK2 100KFECZ	R. METAL 100K	
R312	054 MK2 02K2FECZ	R. METAL 2.2K	
R313	054 MK2 075RFECZ	R. METAL 75R	
R314	054 MK2 100KFECZ	R. METAL 100K	
R315	054 MK2 02K2FECZ	R. METAL 2.2K	
R316	054 MK2 075RFECZ	R. METAL 75R	
R401	054 MK2 001MFECZ	R. METAL 1M	

SYMBOL	PARTS NO.	DESCRIPTION	
R402-R404	054 MK2 022KFECZ	R. METAL 22K	
R405	054 SE10223J	R. ARRAY 22K-10P	
R406-R409	054 MK2 022KFECZ	R. METAL 22K	
R410	054 MK2 010KFECZ	R. METAL 10K	
R411	054 MK2 001KFECZ	R. METAL 1K	
R412	054 MK2 220RFECZ	R. METAL 220R	
R413	054 MK2 04K7FECZ	R. METAL 4.7K	
R601	054 EE10-102	R. METAL 1K	
R701	054 MK2 680RFECZ	R. METAL 680R	
R702,R703	054 MK2 02K7FECZ	R. METAL 2.7K	
R721	054 MK2 022KFECZ	R. METAL 22K	
R722,R723	054 MK2 100KFECZ	R. METAL 100K	
R749,R750	054 MK2 04M7FECZ	R. METAL 4.7M	
R751,R752	054 EE10-152	R. METAL 1.5K	
R753,R754	054 MF1/4-6800F	R. METAL 680R	
R757,R758	054 EE10-392	R. METAL 3.9K	
R757,R758	054 EE10-392	R. METAL 3.9K	
R759,R760	054 EE10-622	R. METAL 6.2K	
R761,R762	054 MF1/4-3901F	R. METAL 3.9K	
R763,R764	054 MF1/4-2701F	R. METAL 2.7K	
R765,R766	054 MK2 560KFECZ	R. METAL 560K	
R767,R768	054 MF1/4-0750F	R. METAL 75R	
R771-R774	054 MK2 680RFECZ	R. METAL 680R	
R781-R784	054 MF1/4-0470F	R. METAL 47R	
R785,R786	054 MF1/4-4700F	R. METAL 470	
R801	054 MK2 022KFECZ	R. METAL 22K	
R802	054 MK2 010KFECZ	R. METAL 10K	
R803	054 MK2 015RFECZ	R. METAL 15R	
R804	054 MK2 039KFECZ	R. METAL 39K	
R805	054 MK2 150KFECZ	R. METAL 150K	
R806	054 MK2 010KFECZ	R. METAL 10K	
R807	054 MK2 02K2FECZ	R. METAL 2.2K	
R808,R809	054 MK2 015KFECZ	R. METAL 15K	
R810	054 MK2 470RFECZ	R. METAL 470R	
R921,R922	054 MK2 05K6FECZ	R. METAL 5.6K	
R923,R924	054 MK2 220RFECZ	R. METAL 220R	
R925,R926	054 MK2 560RFECZ	R. METAL 560R	
R927,R928	054 MK2 02K7FECZ	R. METAL 2.7K	
R929,R930	054 MK2 04K7FECZ	R. METAL 4.7K	
R931,R932	054 MK2 01K8FECZ	R. METAL 1.8K	
R941	054 MK2 001KFECZ	R. METAL 1K	
R942	054 MK2 010KFECZ	R. METAL 10K	
S101	063 EG2-9NU	RELAY	
S102	063 EG2-24NU	RELAY	
T401	032 2SA1016K-FG	TRANSISTOR	
T402	2SC2362K-FG	TRANSISTOR	
T701,T702	033 2SD600K-EF	TRANSISTOR	
T703	033 2SB631K-EF	TRANSISTOR	
T721,T722	032 2SC536K-FG	TRANSISTOR	
T771	033 2SC2362K-FG	TRANSISTOR	

SYMBOL	PARTS NO.	DESCRIPTION
	<u>016 X-1235-01 PCB ASSMRLY</u>	
C301	041 ECEALAEFS101	CAP. ELEC 25V100UF
C302	046 50V 473K	CAP. CERA 50V 0.047UF
C303	046 50V 330J	CAP. CERA CH33PF
C304	041 ECEALAEFS101	CAP. ELEC 25V100UF
C305	046 50V 473K	CAP. CERA 50V 0.047UF
C306	046 50V 330J	CAP. CERA CH33PF
C307	041 U35V33	CAP. ELEC 35V33UF
C308	044 BF014D 0103J	CAP. M.P 63V 0.01UF
C309	041 UVX1C101MEA	CAP. ELEC 16V100UF
C310	043 50V ZF103	CAP. CERA 50V 0.01UF
C311	041 U35V33	CAP. ELEC 35V33UF
C312	044 BF014D 0103J	CAP. M.P 63V 0.01UF
C313	041 ECEALAEFS101	CAP. ELEC 25V100UF
C314	046 50V 473K	CAP. CERA 50V 0.047UF
C315	046 50V 330J	CAP. CERA CH33PF
C316	041 U35V33	CAP. ELEC 35V33UF
C317	044 BF014D 0103J	CAP. M.P 63V 0.01UF
C318	041 ECEALAEFS101	CAP. ELEC 25V100UF
C319	046 50V 473K	CAP. CERA 50V 0.047UF
C320	046 50V 330J	CAP. CERA CH33PF
C321	041 UVX1C101MEA	CAP. ELEC 16V100UF
C322	043 50V ZF103	CAP. CERA 50V 0.01UF
C323	041 U35V33	CAP. ELEC 35V33UF
C324	044 BF014D 0103J	CAP. M.P 63V 0.01UF
C325	041 ECEALAEFS101	CAP. ELEC 25V100UF
C326	046 50V 473K	CAP. CERA 50V 0.047UF
C327	046 50V 330J	CAP. CERA CH33PF
C328	041 U35V33	CAP. ELEC 35V33UF
C329	044 BF014D 0103J	CAP. M.P 63V 0.01UF
C330	041 ECEALAEFS101	CAP. ELEC 25V100UF
C331	046 50V 473K	CAP. CERA 50V 0.047UF
C332	041 25BGF 47M	CAP. ELEC 25V47UF
C333	044 BF014D 0103J	CAP. M.P 63V 0.01UF
C334	044 BF014D 0104J	CAP. M.P 63V 0.1UF
C335	041 UVX1C101MEA	CAP. ELEC 16V100UF
C336	043 50V ZF103	CAP. CERA 50V 0.01UF
C337	041 UVX1C101MEA	CAP. ELEC 16V100UF
C338	043 50V ZF103	CAP. CERA 50V 0.01UF
C351	041 UVX1C101MEA	CAP. ELEC 16V100UF
C352	043 50V ZF103	CAP. CERA 50V 0.01UF
C353	041 UVX1C101MEA	CAP. ELEC 16V100UF
C354	043 50V ZF103	CAP. CERA 50V 0.01UF
C401	041 UVX1C101MEA	CAP. ELEC 16V100UF
C402	046 50V 473K	CAP. CERA 50V 0.047UF
C403,C404	046 50V 330J	CAP. CERA CH33PF
C405	041 UVX1C101MEA	CAP. ELEC 16V100UF
C406	043 50V ZF103	CAP. CERA 50V 0.01UF
C407	041 UVX1C101MEA	CAP. ELEC 16V100UF
C408	043 50V ZF103	CAP. CERA 50V 0.01UF

SYMBOL	PARTS NO.	DESCRIPTION
C601	041 25BGF100M	CAP. ELEC 25V100UF
C602	046 50V 473K	CAP. CERA 50V 0.047UF
C603	041 25BGF100M	CAP. ELEC 25V100UF
C604	046 50V 473K	CAP. CERA 50V 0.047UF
C605	044 BF014D 0103J	CAP. M.P 63V 0.01UF
C606	044 PRS100V473G	CAP. P.P 100V0.047UF
C607	044 BF014D 0103J	CAP. M.P 63V 0.01UF
C611	041 UVX1C101MEA	CAP. ELEC 16V100UF
C612	043 50V ZF103	CAP. CERA 50V 0.01UF
C613	041 UVX1C101MEA	CAP. ELEC 16V100UF
C614	043 50V ZF103	CAP. CERA 50V 0.01UF
C615	041 UVX1C101MEA	CAP. ELEC 16V100UF
C616	043 50V ZF103	CAP. CERA 50V 0.01UF
C617	041 UVX1C101MEA	CAP. ELEC 16V100UF
C618	043 50V ZF103	CAP. CERA 50V 0.01UF
C701,C702	041 25BGF100M	CAP. ELEC 25V100UF
C703	046 50V 473K	CAP. CERA 50V 0.047UF
C704,C705	041 25BGF100M	CAP. ELEC 25V100UF
C706	046 50V 473K	CAP. CERA 50V 0.047UF
C707,C708	041 25BGF100M	CAP. ELEC 25V100UF
C709,C710	046 50V 473K	CAP. CERA 50V 0.047UF
C711	041 25BGF 47M	CAP. ELEC 25V47UF
C749,C750	044 FSC160V102H	CAP. STYROL 160V1000PF
C751,C752	044 PRS100V223G	CAP. P.P 100V0.0022UF
C755-C758	044 FSC160V681H	CAP. STYROL 160V680PF
C761,C762	041 25BGF100M	CAP. ELEC 25V100UF
C763,C764	044 FSC160V102H	CAP. STYROL 160V1000PF
C771-C774	041 25BGF100M	CAP. ELEC 25V100UF
C775,C776	046 50V 473K	CAP. CERA 50V 0.047UF
C777-C780	041 25BGF100M	CAP. ELEC 25V100UF
C781,C782	046 50V 473K	CAP. CERA 50V 0.047UF
C801	041 U25V100	CAP. ELEC 25V100UF
C901-C912	043 500VZF103	CAP. CERA 500V0.01UF
C921,C922	041 LGS1H472MES	CAP. ELEC 50V4700UF
C923,C924	041 25BGF100M	CAP. ELEC 25V100UF
C925,C926	041 25BGF470M	CAP. ELEC 25V470UF
C927,C928	046 50V 473K	CAP. CERA 50V 0.047UF
C941	041 U50V010	CAP. ELEC 50V1UF
C951	041 LGS1H472MES	CAP. ELEC 50V4700UF
C952	041 25BGF470M	CAP. ELEC 25V470UF
C953	046 50V 473K	CAP. CERA 50V 0.047UF
C961	041 LGS1H472MES	CAP. ELEC 50V4700UF
C962	041 25BGF470M	CAP. ELEC 25V470UF
C963	046 50V 473K	CAP. CERA 50V 0.047UF
C971-C975	043 500VZF103	CAP. CERA 500V0.01UF
C978	043 500VZF103	CAP. CERA 500V0.01UF
C981,C982	043 500VZF103	CAP. CERA 500V0.01UF
C985,C986	043 500VZF103	CAP. CERA 500V0.01UF
D401	034 RD3.9HST1	ZENER DIODE
D402	034 1N4003-TB	DIODE

SYMBOL	PARTS NO.	DESCRIPTION
T772	032 2SA1016K-FG	TRANSISTOR
T773	033 2SC2362K-FG	TRANSISTOR
T774	032 2SA1016K-FG	TRANSISTOR
T781, T782	033 2SK366-GR	TRANSISTOR
T783, T784	033 2SJ107-GR	TRANSISTOR
T801, T802	032 2SC2274K-EF	TRANSISTOR
T803	032 2SC536K-FG	TRANSISTOR
T804	032 2SA608K-FG	TRANSISTOR
T805	032 2SA984K-EF	TRANSISTOR
T921	032 2SA1016K-FG	TRANSISTOR
T923	033 2SD1666-RS	TRANSISTOR
T924	033 2SB1133-RS	TRANSISTOR
T926	033 2SA1016K-FG	TRANSISTOR
T927	033 2SC2362K-FG	TRANSISTOR
T928	033 2SA1016K-FG	TRANSISTOR
U301, U302	031 TC74HC04AP	IC
U303	031 TC74HC08AP	IC
U304	031 TC74HC04AP	IC
U351, U352	031 TC74HC151AP	IC
U401	031 SC405588B	IC
U402	031 ST24C01B6	IC
U403	031 TC74HC14AP	IC
U601	031 CS8412CP	IC
U611	031 TC74HC02AP	IC
U612	031 TC74HC86AP	IC
U613	031 TC74HC175AP	IC
U614	031 TC74HC14AP	IC
U701	031 AK4328VP	IC
U751, U752	031 AD711JN	IC
U951	031 NJM7809FA	IC
U961	031 NJM7805FA	IC
X401	023 CSA2.00MHZ	CERAMIC FILTER
<u>016 X-1235-02 PCB ASSMBLY</u>		
C501	043 50V ZF103	CAP. CERA 50V 0.01UF
C502, C503	041 UVX1C101MEA	CAP. ELEC 16V100UF
C502, C503	041 UVX1C101MEA	CAP. ELEC 16V100UF
C504	043 50V ZF103	CAP. CERA 50V 0.01UF

SYMBOL	PARTS NO.	DESCRIPTION
D502-D506	034 LTL232	LED
D507	034 LTL202	LED
D508	034 LTL252	LED
D509	034 LTL202	LED
D510	034 LTL252	LED
D511	034 LTL202	LED
D512-D515	034 LTL252	LED
R502	054 MK2 02K7FECZ	R. METAL 2.7K
U501	031 SBX1610-02	IC
U502	031 TB62701N	IC
S501-S510	061 4TR-2977	TACT SWITCH
<u>016 X-1235-03 PCB ASSMBLY</u>		
C991	044 DE7150F472M	SPARK KILLER Δ
S901	061 C3600B	POWER SWITCH Δ
<u>016 X-1236-00 PCB ASSMBLY</u>		
L991	019 TRL-356	coil Δ
<u>OTHERS</u>		
D517	034 SEL1124R	LED
	072 4TR-670#4	AC CORD US Δ
	072 C-3039	AC CORD EUROPE Δ
	072 4TR-3083	AC CORD UK Δ
	072 C-3763C01	AC CORD AUSTRALIA Δ
	011 TFP-683	FRNT PANEL
	014 3TTE-6#4	UPPER COVER
	019 4TSH-19#2	PLASTIC FOOT

Schematic Diagram RDP-980

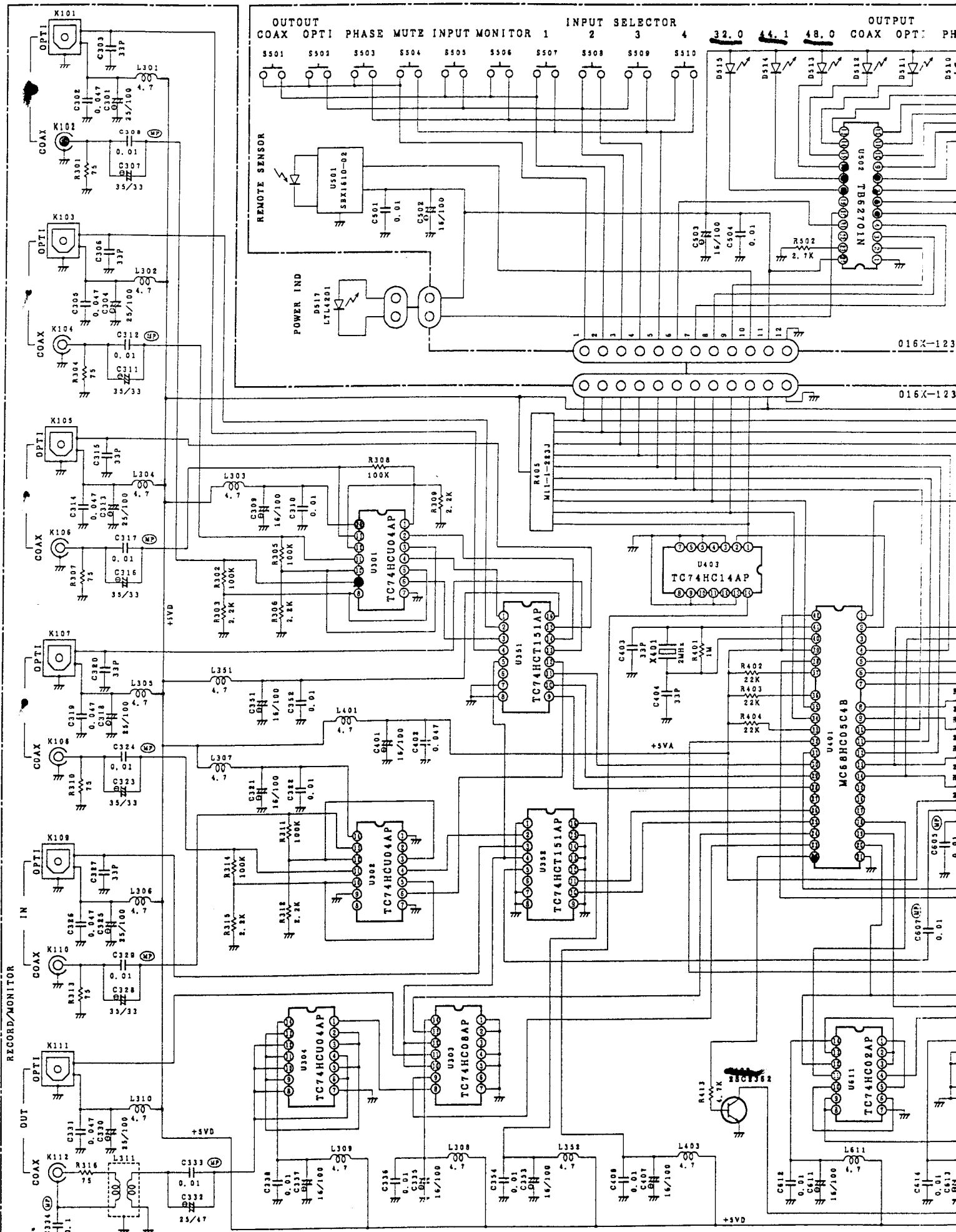

POWER

VERSION 2

OUT COAX IN COAX OPTI OPTI OPTI

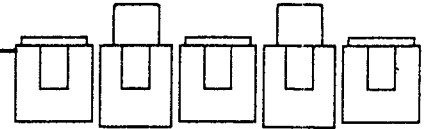
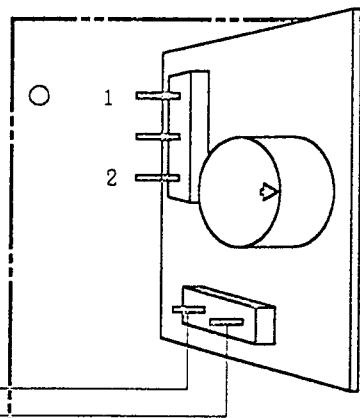
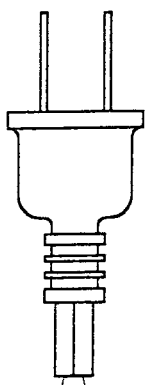

016X-1236B00

POWER

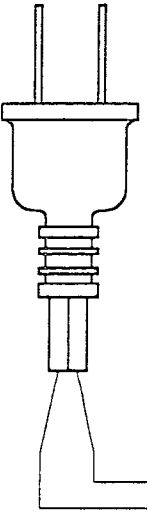

VERSION 1

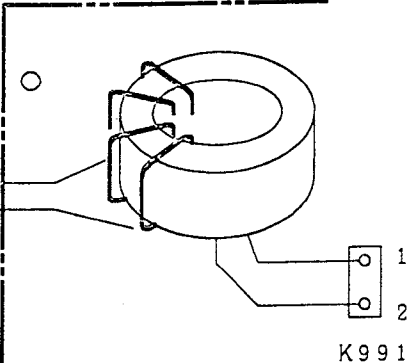

F991

T-1049NF-1

T-1048NF-1

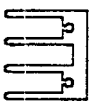
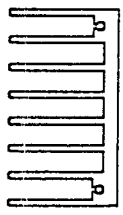
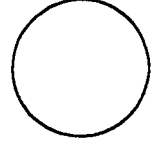
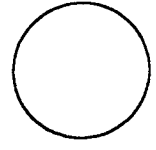
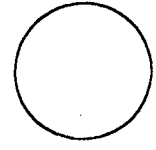
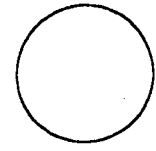

K991

K992

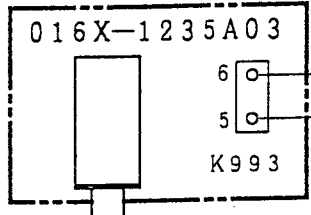

016X-1235A03

6

5

K993

WHT

BRN

POWER SW

BLK

RED

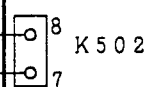

K502

016X-1235A02

POWER IND.

RDP-980

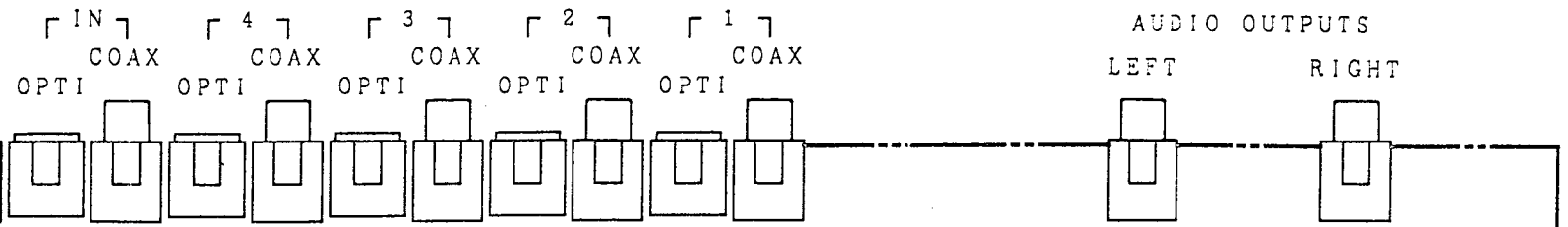

—1236B00

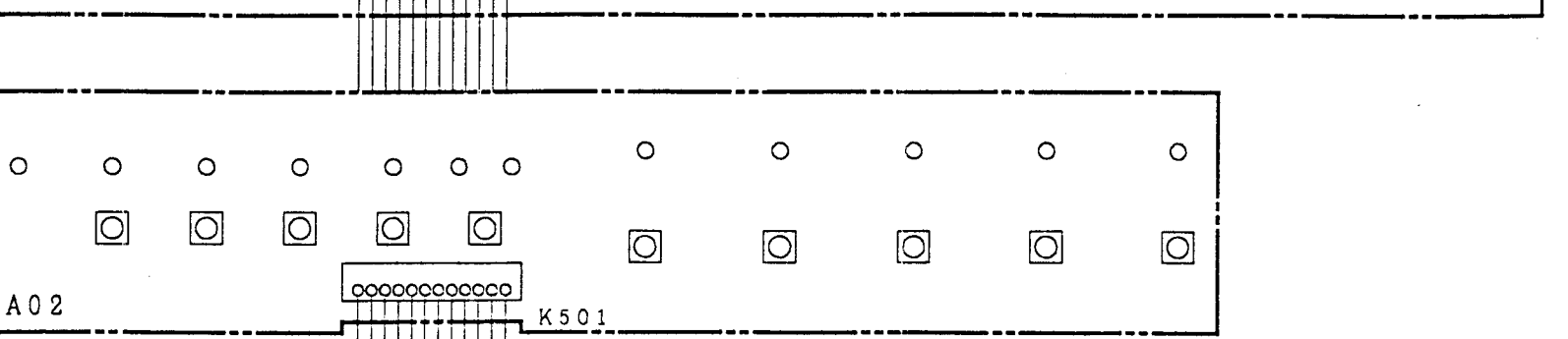
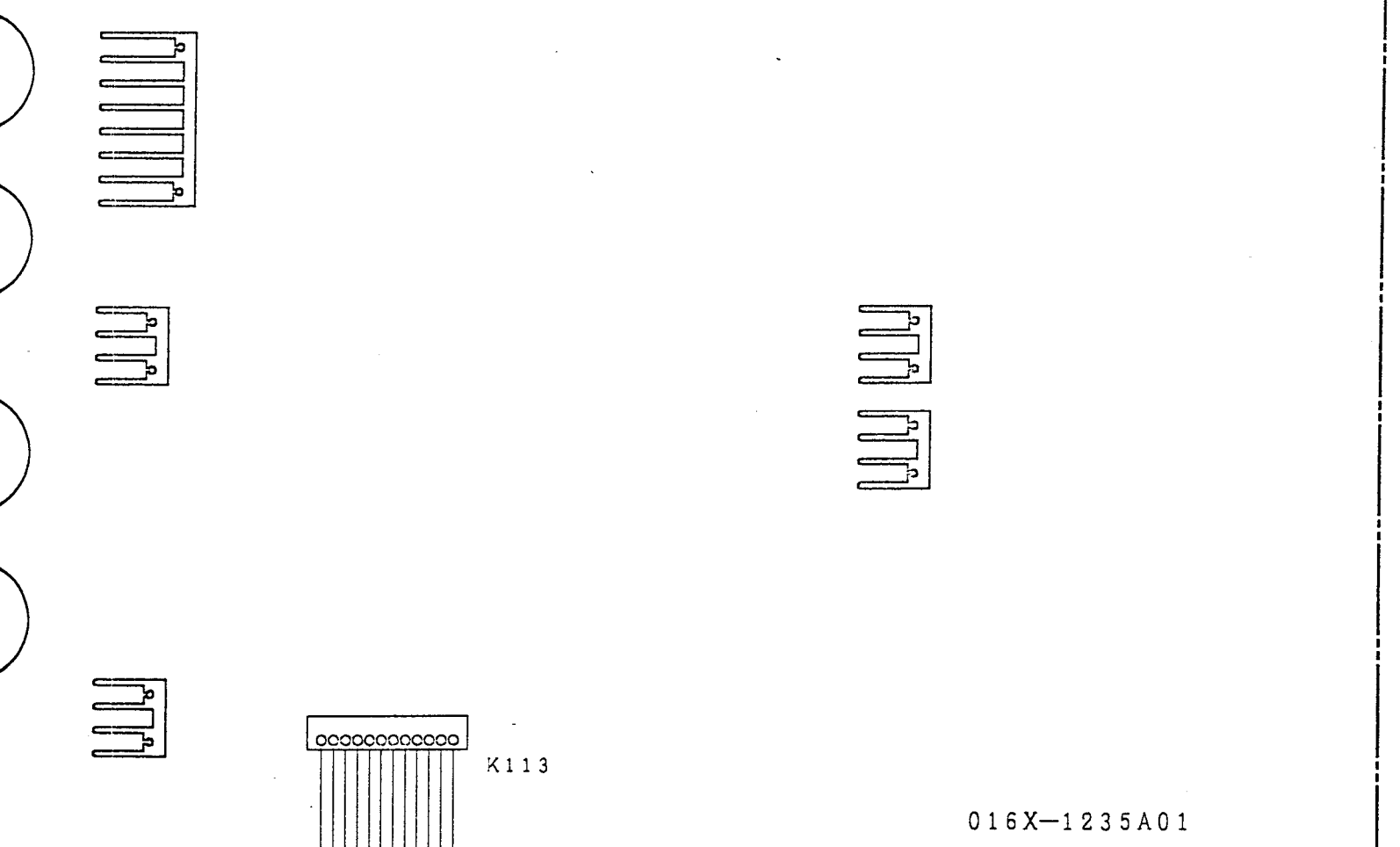

ATTENTION : Afin d'assurer une protection permanente contre les risques incendie, remplacez uniquement par un fusible de même type

CAUTION: For continued protection against fire hazard replace with same type fuse

500mA

DIGITAL TRAIN POWER SUPPLIES

MAIN POWER SUPPLIES

016X-1235A03

016X-1235A02

