



# Technical Manual

# FM STEREO TUNER RHT10

### TABLE OF CONTENTS

- Chassis Layout..... 1
- Specifications..... 2
- Block Diagram..... 3
- Adjustment..... 4
- PC Board Ass'y Parts List..... 6
- Schematic Diagram..... 12
- Wiring Diagram..... 16
- Printed Circuit Board..... 18

**THE ROTEL CO., LTD.**  
 1-36-8, OHOKAYAMA, MEGURO-KU, TOKYO 152, JAPAN  
**ROTEL ELECTRONICS CO., LTD.**  
 3F-2, NO.35, FU HSING NORTH ROAD, TAIPEI, TAIWAN, REPUBLIC OF CHINA

# Chassis Layout

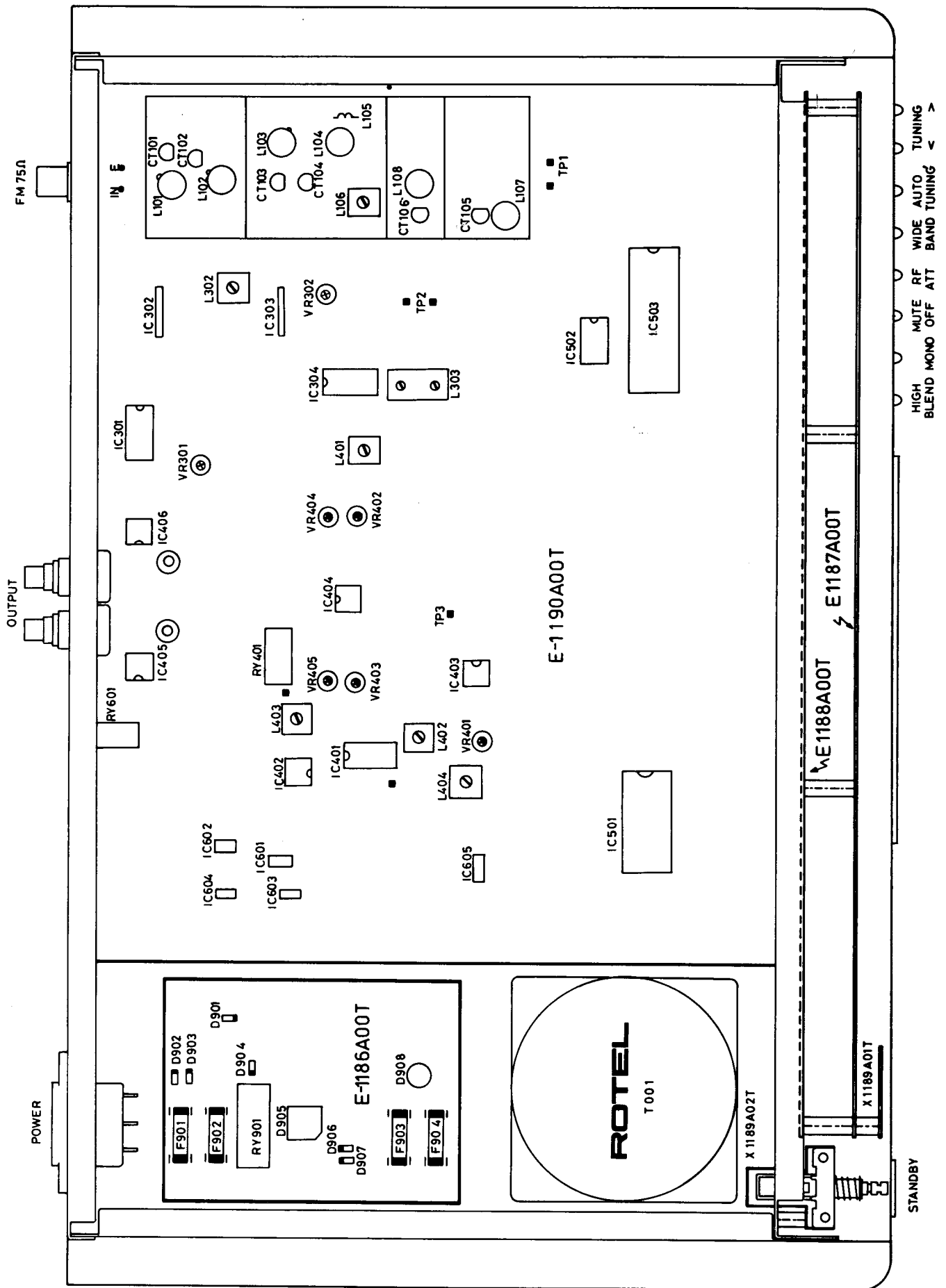

# Specifications

|  |  |
|--|--|
| Frequency Range .....                  | 87.5 to 108 MHz                            |
| Antenna Input Impedance.....           | 75 ohms unbalanced                         |
| Usable Sensitivity                     |  |
| Mono (Wide).....                       | 10.8 dBf (0.95 $\mu$ V) at 75 ohms         |
| (Narrow) .....                         | 17.2dBf (2 $\mu$ V) at 75 ohms             |
| 50 dB Quieting Sensitivity:            |  |
| Mono .....                             | 14.8 dBf (1.5 $\mu$ V) at 75 ohms          |
| Stereo .....                           | 37.2 dBf (20 $\mu$ V) at 75 ohms           |
| Capture Ratio .....                    | 1.0 dB                                     |
| Alternate Channel Selectivity:         |  |
| Wide.....                              | 60 dB                                      |
| Narrow.....                            | 80 dB                                      |
| Adjacent Channel Selectivity .....     | 25 dB (Narrow) <i>5 to 6 dB wide.</i>      |
| Spurious Response Ratio .....          | 100 dB                                     |
| Image Response Ratio .....             | 80 dB                                      |
| IF Response Ratio .....                | 100 dB                                     |
| AM Suppression Ratio .....             | 60 dB                                      |
| Sub carrier Product Ratio .....        | 60 dB                                      |
| SCA Rejection Ratio.....               | 70 dB                                      |
| Muting Threshold.....                  | 18 $\mu$ V                                 |
| Output Level.....                      | 1.5 Vrms                                   |
| Frequency Response.....                | 30 to 15,000 Hz $\pm$ 0.5 dB               |
| Signal to Noise Ratio (at 65 dBf):     |  |
| Mono .....                             | 87 dB                                      |
| Stereo .....                           | 82 dB                                      |
| Harmonic Distortion (at 65 dBf, Wide): |  |
| Mono .....                             | 0.05 % at 1 kHz                            |
| Stereo .....                           | 0.1 % at 1 kHz                             |
| Stereo Separation:                     |  |
| 100 Hz.....                            | 45 dB                                      |
| 1 kHz.....                             | 50 dB                                      |
| 10 kHz.....                            | 40 dB                                      |
| De-emphasis .....                      | 50 $\mu$ S (Europe), 75 $\mu$ S (Americas) |
| Power Requirement.....                 | 120V, 230V or 240V, 50/60Hz                |
| Power Consumption .....                | 12 W                                       |
| Overall Dimensions .....               | 470(w) x 76 (h) x 332 (d) mm               |
|  | 18 1/2"(w) x 3"(h) x 13 1/16"(d)           |
| Net Weight .....                       | 5.5 kg/ 12.1 lbs                           |

NOTE: Specifications and design are subject to possible modification without notice.

# Block Diagram

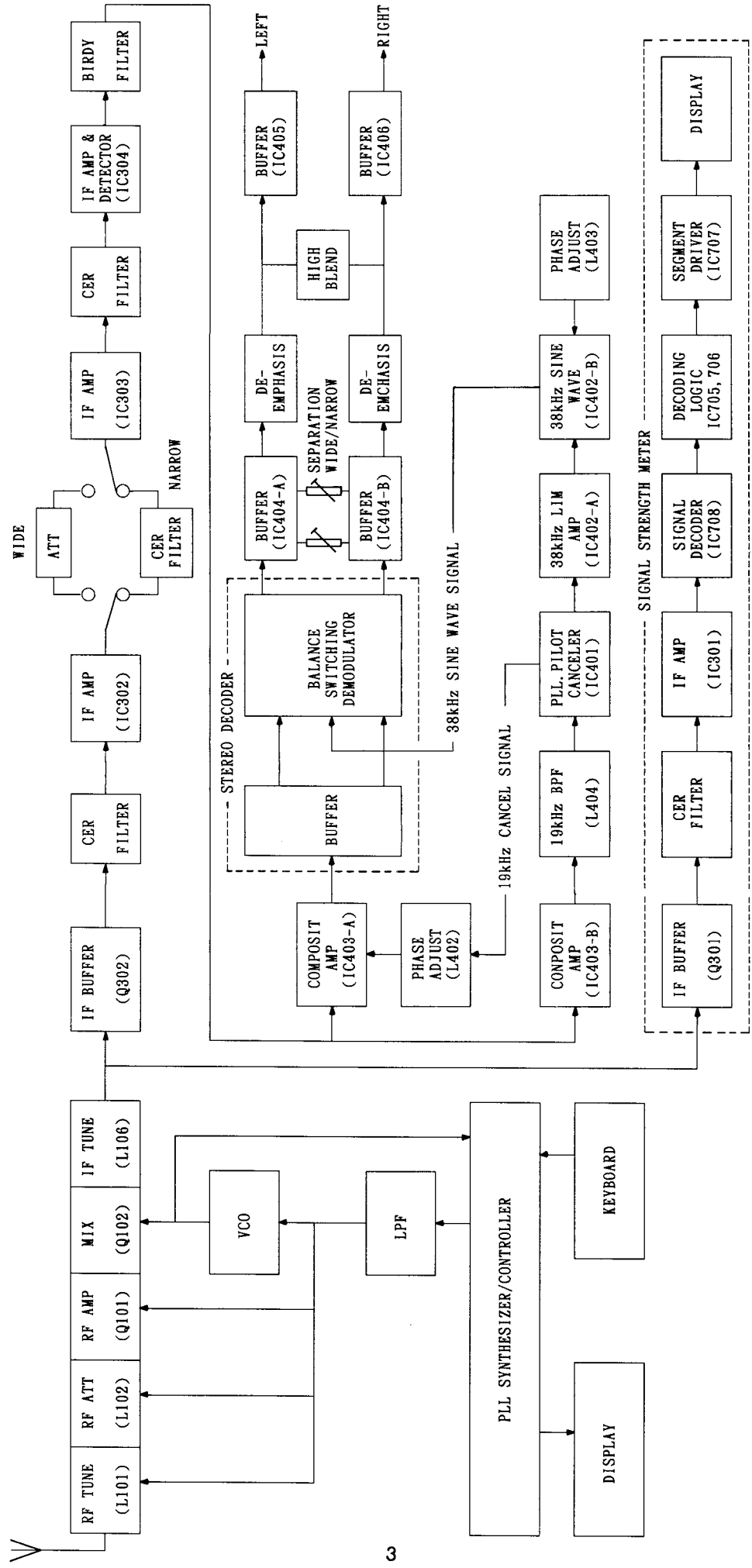

# FM IF and RF Alignment

Instruments: FM Signal Generator (400Hz,100% Modulated), THD Analyzer, Oscilloscope, AC VTVM, DC Voltmeter, Tuning Meter.

Test point : DC Voltmeter---Between TP1 and Earth on 016E1190A00T P.C.B.  
Tuning Meter---Between TP2 A and B on 016E1190A00T P.C.B.

| Step | Generator  |           | Tuning Dial Setting | Adjust                           | Adjust for                                 |
|------|--|-----------|---------------------|----------------------------------|--|
|      | Coupling   | Frequency |                     |                                  |  |
| 1    | N/A  |           | 87.5 MHz            | L107                             | 3V reading on DC Voltmeter                 |
| 2    |  |           | 108 MHz             | CT105                            | 22V reading on DC Voltmeter                |
| 3    | Repeat steps 1 and 2 unit until no further improvement is noticed.                           |           |                     |                                  |  |
| 4    | Antenna terminal   | 90 MHz    | 90 MHz              | L101,102<br>L103,104<br>L107,108 | Maximum reading on AC VTVM.                |
| 5    |  | 105 MHz   | 105 MHz             | CT101-<br>CT104<br>CT106         | Maximum reading on AC VTVM.                |
| 6    | Repeat steps 4 and 5 unit until no further improvement is noticed. (muting OFF) (RFF ATT ON) |           |                     |                                  |  |
| 7    | Antenna terminal<br>1mV input  | 90 MHz    | 90 MHz              | L303(A)                          | Adjust center on Tuning Meter              |
| 8    |  |           |                     | L303(B)                          | Minimum reading on THD Analyzer            |
| 9    | Repeat steps 7 and 8 unit until no further improvement is noticed. (Muting OFF)              |           |                     |                                  |  |
| 10   | Antenna terminal<br>5uV input  | 90 MHz    | 90 MHz              | VR302                            | Muting Level (Muting ON)                   |
| 11   | Antenna terminal<br>1mV input  | 90 MHz    | 90 MHz              | VR301                            | Signal Indicator Level To "7" (Muting OFF) |

# FM MPX Alignment

Instruments: FM Stereo Generator, AC VTVM, Oscilloscope.

Test point : When adjust pilot cancel---Between TP3 and Earth  
on 016E1190A00T P.C.B.

| Step | Generator   |  | Tuning Dial Setting | Adjust         | Adjust for  |
|------|---|--|---------------------|----------------|---|
|      | Coupling  | Frequency  |                     |                |   |
| 1    | Antenna terminal<br>1mV input   | 98 MHz Mod<br>Pilot--10%<br>1 kHz--90%<br>Sub signal<br>(L or R) | 98 MHz              | L403<br>L404   | VCO 76kHz+/-100Hz<br>Maximum reading<br>on AC VTVM<br>at output.  |
| 2    |   | 98 MHz Mod<br>Pilot--10%   |                     | VR401<br>L402  | Pilot cancel<br>Minimum reading<br>on AC VTVM<br>at TP3.          |
| 3    |   | 98 MHz Mod<br>Pilot--10%<br>1 kHz--90%<br>(L or R)               |                     | VR402<br>VR403 | Separation (Wide)<br>Minimum reading<br>on AC VTVM<br>at output.  |
| 4    |   |  |                     | VR404<br>VR405 | Separation<br>(Narrow) Minimum<br>reading on AC<br>VTVM at output |
| Note | It will be better to use 38 KHz low pass filter when adjust Separation. |  |                     |                |   |

## CHANGING THE FM BAND FOR DIFFERENT MARKETS

|              | J501  | FREQUENCY RANGE  | TUNING INTERVAL |
|--------------|-------|------------------|-----------------|
| USA          | OPEN  | 87.5 MHz—108 MHz | 100 kHz         |
| EUROPE<br>UK | CLOSE | 87.5 MHz—108 MHz | 50 kHz          |

## PRESETTING FM DE-EMPHASIS

|              | J401, J402 | DE-EMPHASIS |
|--------------|------------|-------------|
| USA          | CLOSE      | 75 $\mu$ S  |
| EUROPE<br>UK | OPEN       | 50 $\mu$ S  |

## PRESETTING FM MUTING (AUTO-STOP) LOCK RANGE

|              | J301  | LOCK RANGE   |
|--------------|-------|--------------|
| USA          | CLOSE | $\pm$ 70 kHz |
| EUROPE<br>UK | OPEN  | $\pm$ 30 kHz |

# Parts List

NOTE: THE COMPONENTS INDENTIFIED BY  $\Delta$  MARK ARE FOR SAFETY. REPLACE ONLY WITH ORIGINAL PARTS. DO NOT SUBSTITUTE.

| SYMBOL                  | PARTS NO.  | DESCRIPTION                         |
|-------------------------|------------|-------------------------------------|
| E-1186A00T PCB ASSEMBLY |            |                                     |
| R901, 902               | RM81002616 | R, METAL MK2010KFECZ.               |
| R903                    | RM84752616 | R, METAL MK247K5FECZ.               |
| C901                    | CC01009256 | CAP, CERAMIC 0.01uF 250V $\Delta$   |
| C902                    | CE01007504 | CAP, ELEC. 1uF 50V                  |
| C903, 904               | CC01009256 | CAP, CERAMIC 0.01uF 250V $\Delta$   |
| C905                    | CE04705358 | CAP, ELEC. 470uF 35V                |
| C906-909                | CC01009256 | CAP, CERAMIC 0.01uF 250V $\Delta$   |
| C910, 911               | CE64704449 | CAP, ELEC. LGS1H472MHS              |
| C912                    | CE02205449 | CAP, ELEC. 220uF 63V                |
| C913, 914               | CC01009256 | CAP, CERAMIC 0.01uF 250V $\Delta$   |
| C915                    | CE02205449 | CAP, ELEC. 220uF 63V                |
| C916-919                | CC01009256 | CAP, CERAMIC 0.01uF 250V $\Delta$   |
| C920                    | CE04705164 | CAP, ELEC. 470uF 16V                |
| D901-904                | DD1000068  | DIODE IN4003                        |
| D905                    | DD10000380 | DIODE BR-64                         |
| D906, 907               | DD1000068  | DIODE IN4003                        |
| D908                    | DD10000123 | DIODE W02                           |
| RY901                   | LY00000289 | RELAY VB-24SMCU-E $\Delta$          |
| F901, 902               | FU25000077 | FUSE 250V T1A UL/CAS $\Delta$       |
|                         | FU23000207 | FUSE 250V T1A S $\Delta$            |
| Q901                    | TR10000059 | TRANSISTOR 2SB764E/F                |
| E-1187A00T PCB ASSEMBLY |            |                                     |
| R801                    | RM81002616 | R, METAL MK2010KFECZ.               |
| R802                    | RM84752616 | R, METAL MK247K5FECZ.               |
| R803                    | RM81002616 | R, METAL MK2010KFECZ.               |
| R804-812                | RM81211618 | R, METAL MK21K21FECZ.               |
| R813-817                | RM84752616 | R, METAL MK247K5FECZ.               |
| R818                    | RM81212611 | R, METAL MK212K1FECZ.               |
| R819                    | RM81002616 | R, METAL MK2010KFECZ.               |
| R820-823                | RM82212618 | R, METAL MK222K1FECZ.               |
| R824-827                | RM81001612 | R, METAL MK2001KFECZ.               |
| R828                    | RM81002616 | R, METAL MK2010KFECZ.               |
| R829, 830               | RM82212618 | R, METAL MK222K1FECZ.               |
| R831, 832               | RM81001612 | R, METAL MK2001KFECZ.               |
| R833, 834               | RM86812616 | R, METAL MK268K1FECZ.               |
| R835-841                | RM81211618 | R, METAL MK21K21FECZ.               |
| C801-806                | CC31009465 | CAP, CERAMIC 0.01uF 50V             |
| C807, 808               | CY21008428 | CAP, LAYER 50MSA104J                |
| C809, 810               | CC31009465 | CAP, CERAMIC 0.01uF 50V             |
| D801-806                | DD40001245 | LED LN21RPH                         |
| D807, 808               | DD80000021 | DIODE IN4148                        |
| Q801                    | TR30000327 | TRANSISTOR 2SC536G-NP               |
| Q802                    | TR10000126 | TRANSISTOR 2SA608KF                 |
| Q803, 804               | TR30000327 | TRANSISTOR 2SC536G-NP               |
| FL801                   | DD40000976 | FL TUBE FIP7F8S                     |
| D809-811                | DD40001233 | LED LN513RK                         |
| IC801                   | IC00002740 | uPD4511BAC                          |
| IC802                   | IC00002107 | TC9130P                             |
| S801-808                | SH60000252 | KEY BOARD SW 4TR-2627               |
| E-1188A00T PCB ASSEMBLY |            |                                     |
| R701                    | RM34702085 | THICK FILM RS NETWORK<br>RAB-473-8K |
| R709-715                | RM84752616 | R, METAL MK247K5FECZ.               |
| R716                    | RM81502613 | R, METAL MK2015KFECZ.               |
| R717, 718               | RM81002616 | R, METAL MK2010KFECZ.               |
| R719                    | RM81502613 | R, METAL MK2015KFECZ.               |
| R720                    | RN34702085 | THICK FILM RS NETWORK<br>RAB-473-8K |
| R728-733                | RM81002616 | R, METAL MK2010KFECZ.               |
| R734                    | RM82212618 | R, METAL MK222K1FECZ.               |
| R735-737                | RM81002616 | R, METAL MK2010KFECZ.               |
| R738-740                | RM84752616 | R, METAL MK247K5FECZ.               |
| R741-743                | RM81002616 | R, METAL MK2010KFECZ.               |
| R747                    | RN32202081 | THICK FILM RS NETWORK<br>SE8223JFU  |

| SYMBOL                  | PARTS NO.  | DESCRIPTION                        |
|-------------------------|------------|------------------------------------|
| R752                    | RN32202068 | THICK FILM RS NETWORK<br>SE6223JFU |
| R758                    | RN32202081 | THICK FILM RS NETWORK<br>SE8223JFU |
| C701-704                | CC31009465 | CAP, CERAMIC 0.01uF 50V            |
| C705                    | CE01007504 | CAP, ELEC. 1uF 50V                 |
| C706                    | CE04706168 | CAP, ELEC. 47uF 16V                |
| C707                    | CE03306250 | CAP, ELEC. 33uF 25V                |
| C708, 709               | CE01007504 | CAP, ELEC. 1uF 50V                 |
| C710                    | CC31009465 | CAP, CERAMIC 0.01uF 50V            |
| C711                    | CC31010431 | CAP, CERAMIC 0.001uF 50V           |
| C712                    | CC31009465 | CAP, CERAMIC 0.01uF 50V            |
| C713                    | CE04706168 | CAP, ELEC. 47uF 16V                |
| Q701-704                | TR30000327 | TRANSISTOR 2SC536G-NP              |
| Q705, 706               | TR10000126 | TRANSISTOR 2SA608KF                |
| D701-728                | DD80000021 | DIODE IN4148                       |
| IC701, 702              | IC00002727 | IC TC4532BP                        |
| IC703                   | IC00002340 | IC TC4081BP                        |
| IC704                   | IC00001528 | IC TC4013BP                        |
| IC705                   | IC00002065 | IC TC74HC148P                      |
| IC706                   | IC00002363 | IC TC4011BP                        |
| IC707                   | IC00002740 | IC uPD4511BAC                      |
| IC708                   | IC00002739 | IC LB1407                          |
| IC709                   | IC00000573 | IC TD6301AP                        |
| X-1189A01T PCB ASSEMBLY |            |                                    |
| IC001                   | IC00002030 | REMOTE RECEIVER SBX1610-02         |
| X-1189102T PCB ASSEMBLY |            |                                    |
| S001                    | SH11000458 | 1 KEY PUSH SW SUN 4TR-2911         |
| X-1189A03T PCB ASSEMBLY |            |                                    |
| D001                    | DD40001257 | LED LN16WP                         |
| E-1190A00T PCB ASSEMBLY |            |                                    |
| R101, 102               | RM84751612 | R, METAL MK24K75FECZ.              |
| R103                    | RM82743612 | R, METAL MK227K4FECZ.              |
| R105                    | RM82743612 | R, METAL MK227K4FECZ.              |
| R106, 107               | RM81003610 | R, METAL MK2100KFECZ.              |
| R108                    | RM84752616 | R, METAL MK247K5FECZ.              |
| R109                    | RM84759611 | R, METAL MK247R5FECZ.              |
| R110                    | RM81500616 | R, METAL MK2150RFECZ.              |
| R111, 112               | RM82742619 | R, METAL MK227K4FECZ.              |
| R113, 114               | RM81003610 | R, METAL MK2100KFECZ.              |
| R115                    | RM84759611 | R, METAL MK247R5FECZ.              |
| R116                    | RM82211614 | R, METAL MK22K21FECZ.              |
| R117                    | RM81000619 | R, METAL MK2100RFECZ.              |
| R118                    | RM82211614 | R, METAL MK22K21FECZ.              |
| R119                    | RM81002616 | R, METAL MK2010KFECZ.              |
| R120                    | RM84752616 | R, METAL MK247K5FECZ.              |
| R121                    | RM81002616 | R, METAL MK2010KFECZ.              |
| R122                    | RM84752616 | R, METAL MK247K5FECZ.              |
| R123                    | RM81002616 | R, METAL MK2010KFECZ.              |
| R124                    | RM84750619 | R, METAL MK2475RFECZ.              |
| R125                    | RM81003610 | R, METAL MK2100KFECZ.              |
| R126                    | RM82211614 | R, METAL MK22K21FECZ.              |
| R127                    | RM84759611 | R, METAL MK247R5FECZ.              |
| R128, 129               | RM81002626 | R, METAL MK2010KFECZ.              |
| R130                    | RM84759611 | R, METAL MK247R5FECZ.              |
| R131                    | RM82742619 | R, METAL MK227K4FECZ.              |
| R132                    | RM81003610 | R, METAL MK2100KFECZ.              |
| R133                    | RM82742619 | R, METAL MK227K4FECZ.              |
| R134                    | RM84750619 | R, METAL MK2475RFECZ.              |
| C101                    | CC33312438 | CAP, CERAMIC 33P 50V               |
| C102                    | CC34712436 | CAP, CERAMIC 47P 50V               |
| C103                    | CC31009465 | CAP, CERAMIC 0.01uF 50V            |

# Parts List

| SYMBOL    | PARTS NO.   | DESCRIPTION              |
|-----------|-------------|--------------------------|
| C104      | CC15013410  | CAP,CERAMIC 5P CH 50V    |
| C105      | CC31009465  | CAP,CERAMIC 0.01uF 50V   |
| C106      | CC31010431  | CAP,CERAMIC 0.001uF 50V  |
| C107      | CC31009465  | CAP,CERAMIC 0.01uF 50V   |
| C108      | CC13013417  | CAP,CERAMIC 3P CH 50V    |
| C109      | CC34712436  | CAP,CERAMIC 47P 50V      |
| C110      | CC31009465  | CAP,CERAMIC 0.01uF 50V   |
| C111      | CC31010431  | CAP,CERAMIC 0.001uF 50V  |
| C112      | CC13013417  | CAP,CERAMIC 3P CH 50V    |
| C113      | CC15013410  | CAP,CERAMIC 5P CH 50V    |
| C114      | CC13013417  | CAP,CERAMIC 3P CH 50V    |
| C115      | CE01007504  | CAP,ELEC. 1uF 50V        |
| C116      | CC31011435  | CAP,CERAMIC 100P 50V     |
| C117-119  | CC31009465  | CAP,CERAMIC 0.01uF 50V   |
| C120      | CE04705164  | CAP,ELEC. 470uF 16V      |
| C121      | CC15013410  | CAP,CERAMIC 5P CH 50V    |
| C122      | CC17013412  | CAP,CERAMIC 7P CH 50V    |
| C123      | CC33312438  | CAP,CERAMIC 33P 50V      |
| C124      | CC15013410  | CAP,CERAMIC 5P CH 50V    |
| C125,126  | CC31009465  | CAP,CERAMIC 0.01uF 50V   |
| C127,128  | CC15013410  | CAP,CERAMIC 5P CH 50V    |
| C129      | CC31009465  | CAP,CERAMIC 0.01uF 50V   |
| C130,131  | CC15013410  | CAP,CERAMIC 5P CH 50V    |
| C132      | CC17013412  | CAP,CERAMIC 7P CH 50V    |
| CT101-106 | CF00000184  | FILM TRIMMER CAP. VCT51A |
| D101      | DD10000317  | DIODE 1SS110             |
| D102      | DD50000055  | DIODE SVC211SPA          |
| D103      | DD10000317  | DIODE 1SS110             |
| D104      | DD50000055  | DIODE SVC211SPA          |
| D105-108  | DD50000055  | DIODE SVC211SPA          |
| Q101,102  | TR50000140  | TRANSISTOR 3SK107F       |
| Q103      | TR300000327 | TRANSISTOR 2SC536G-NP    |
| Q104,105  | TR10000126  | TRANSISTOR 2SA608KF      |
| Q106      | TR300000327 | TRANSISTOR 2SC536G-NP    |
| Q107      | TR50000103  | TRANSISTOR 2SK544F       |
| Q108      | TR30000133  | TRANSISTOR 2SC1674       |
| Q109      | TR50000103  | TRANSISTOR 2SK544F       |
| L101,102  | LC23390009  | FM ANT. COIL TRL-339     |
| L103      | LC23380004  | FM RF COIL TRL-338       |
| L104      | LC23370000  | FM RF COIL TRL-337       |
| L105      | LM00000073  | MICRO INDUCTOR TRL-239   |
| L106      | LC02330000  | FM IF COIL TRL-233T      |
| L107,108  | LC23360005  | FM OSC COIL TRL-336      |
| R301      | RM84759611  | R,METAL MK247R5FECZ.     |
| R302      | RM83320617  | R,METAL MK2332RFECZ.     |
| R303      | RM81003610  | R,METAL MK2100KFECZ.     |
| R304      | RM83320617  | R,METAL MK2332RFECZ.     |
| R305-307  | RM84752616  | R,METAL MK247K5FECZ.     |
| R308      | RM81213615  | R,METAL MK2121KFECZ.     |
| R309      | RM84759611  | R,METAL MK247R5FECZ.     |
| R310      | RM81003610  | R,METAL MK2100KFECZ.     |
| R311      | RM83320617  | R,METAL MK2332RFECZ.     |
| E312      | RM84759611  | R,METAL MK247R5FECZ.     |
| R313,314  | RM83320617  | R,METAL MK2332RFECZ.     |
| R315      | RM84759611  | R,METAL MK247R5FECZ.     |
| R316      | RM82210610  | R,METAL MK2221RFECZ.     |
| R317      | RM83320617  | R,METAL MK2332RFECZ.     |
| R318      | RM81001612  | R,METAL MK2001KFECZ.     |
| R319.320  | RM83320617  | R,METAL MK2332RFECZ.     |
| R321      | RM84759611  | R,METAL MK247R5FECZ.     |
| R322      | RM82212618  | R,METAL MK222K1FECZ.     |
| R323      | RM81003610  | R,METAL MK2100KFECZ.     |
| R324      | RM82212618  | R,METAL MK222K1FECZ.     |
| R325      | RM84759611  | R,METAL MK247R5FECZ.     |
| R326      | RM81002616  | R,METAL MK2010KFECZ.     |
| R327      | RM81000619  | R,METAL MK2100RFECZ.     |
| R328      | RM82212618  | R,METAL MK222K1FECZ.     |
| R329      | RM84751612  | R,METAL MK24K75FECZ.     |
| R330      | RM81002616  | R,METAL MK2010KFECZ.     |

| SYMBOL   | PARTS NO.   | DESCRIPTION                    |
|----------|-------------|--------------------------------|
| R331     | RM84751612  | R,METAL MK24K74FECZ.           |
| R332     | RM81002616  | R,METAL MK2010KFECZ.           |
| R333     | RM82212618  | R,METAL MK222K1FECZ.           |
| R334     | RM81002616  | R,METAL MK2010KFECZ.           |
| R335     | RM84752616  | R,METAL MK247K5FECZ.           |
| R336     | RM83321610  | R,METAL MK23K32FECZ.           |
| R337     | RM84762616  | R,METAL MK247K5FECZ.           |
| R338     | RM81003610  | R,METAL MK2100KFECZ.           |
| R339     | RM81001612  | R,METAL MK2001KFECZ.           |
| R340,341 | RM82211614  | R,METAL MK22K21FECZ.           |
| R342,343 | RM81000619  | R,METAL MK2100RFECZ.           |
| R344     | RM83320617  | R,METAL MK2332RFECZ.           |
| R345     | RM81002616  | R,METAL MK2010KFECZ.           |
| R346     | RM84752616  | R,METAL MK247K5FECZ.           |
| R347     | RM86810619  | R,METAL MK2681RFECZ.           |
| R348     | RM82212618  | R,METAL MK222K1FECZ.           |
| R349     | RM81002616  | R,METAL MK2010KFECZ.           |
| R350-352 | RM84752616  | R,METAL MK247K5FECZ.           |
| R353     | RM88251610  | R,METAL MK28K25FECZ.           |
| R354     | RM84759611  | R,METAL MK247R5FECZ.           |
| R355     | RM82431614  | R,METAL MK22K43FECZ.           |
| R356     | RM82212618  | R,METAL MK222K1FECZ.           |
| C301-303 | CC31009465  | CAP,CERAMIC 0.01uF 50V         |
| C304-312 | CC05009457  | CAP,CERAMIC 0.047uF 50V        |
| C313-328 | CC31009465  | CAP,CERAMIC 0.01uF 50V         |
| C329,330 | CE01006251  | CAP,ELEC. 10uF 25V             |
| C331     | CC31009465  | CAP,CERAMIC 0.01uF 50V         |
| C332-334 | CC05009457  | CAP,CERAMIC 0.047uF 50V        |
| C335     | CE02206508  | CAP,ELEC. 22uF 50V             |
| C336     | CS33311310  | CAP,POLY. 160V 330P            |
| C337,338 | CE01007504  | CAP,ELEC. 1uF 50V              |
| C339-343 | CC05009457  | CAP,CERAMIC 0.047uF 50V        |
| C344     | CE51005679  | CAP,ELEC. 25BGF100M            |
| C345     | CC05009457  | CAP,CERAMIC 0.047uF 50V        |
| C346     | CE51005679  | CAP,ELEC. 25BGF100M            |
| C347     | CE01005258  | CAP,ELEC. 100uF 25V            |
| X301,302 | LF00000099  | CERAMIC FILTER SFE10.7MS3GY-A  |
| X303     | LF00000415  | CERAMIC FILTER SFE10.7MXK-A    |
| X304     | LF00000439  | CERAMIC FILTER SFE10.7M5-A     |
| X305     | LF00000427  | CERAMIC FILTER SFE10.7MHY-A    |
| X306     | LF00000415  | CERAMIC FILTER SFE10.7MXK-A    |
| D301-309 | DD80000021  | DIODE IN4148                   |
| Q301,302 | TR50000103  | TRANSISTOR 2SK544F             |
| Q303-307 | TR300000327 | TRANSISTOR 2SC536G-NP          |
| Q308,309 | TR10000126  | TRANSISTOR 2SA608K             |
| VR301    | RV40000095  | R,SEMI-FIXED VM6CKPV-1S-B 47KB |
| VR302    | RV40000125  | R,SEMI-FIXED VM6CKPV-1S-B 10KB |
| IC301    | IC00001103  | IC LA1235                      |
| IC302    | IC00001516  | IC TA7302P                     |
| IC303    | IC00001656  | IC MPC1163H                    |
| IC304    | IC00001103  | IC LA1235                      |
| L301     | LM00000073  | MICRO FILTER TRL-239           |
| L303     | LC31090007  | IF COIL RLV-109T               |
| R401     | RM81000619  | R,METAL MK2100RFECZ.           |
| R402     | RM82211614  | R,METAL MK22K21FECZ.           |
| R403     | RM84751612  | R,METAL MK24K75FECZ.           |
| R404     | RM86812616  | R,METAL MK268K1FECZ.           |
| R405     | RM83322614  | R,METAL MK233K2FECZ.           |
| R406     | RM81003610  | R,METAL MK2100KFECZ.           |
| R407     | RM88250617  | R,METAL MK2825RFECZ.           |
| R408     | RM81001612  | R,METAL MK2001KFECZ.           |
| R409     | RM84759611  | R,METAL MK247R5FECZ.           |
| R411-413 | RM81002616  | R,METAL MK2010KFECZ.           |
| R414     | RM85621610  | R,METAL MK25K62FECZ.           |
| R416     | RM82211614  | R,METAL MK22K21FECZ.           |
| R417     | RM84752616  | R,METAL MK247K5FECZ.           |
| R418     | RM84759611  | R,METAL MK247R5FECZ.           |



# Parts List

| SYMBOL    | PARTS NO.  | DESCRIPTION                  |
|-----------|------------|------------------------------|
| R419      | RM83322614 | R, METAL MK233K2FECZ.        |
| R420      | RM81002616 | R, METAL MK2010KFECZ.        |
| R421, 422 | RM84751612 | R, METAL MK24K75FECZ.        |
| R423, 424 | RM81003610 | R, METAL MK2100KFECZ.        |
| R425      | RM84752616 | R, METAL MK247K5FECZ.        |
| R426      | RM83323618 | R, METAL MK2332KFECZ.        |
| R427      | RM82213611 | R, METAL MK2221KFECZ.        |
| E428      | RM81003610 | R, METAL MK2100KFECZ.        |
| R429, 430 | RM81001612 | R, METAL MK2001KFECZ.        |
| R431      | RM82212618 | R, METAL MK222K1FECZ.        |
| R432      | RM81002616 | R, METAL MK2010KFECZ.        |
| R433      | RM82212618 | R, METAL MK222K1FECZ.        |
| R434      | RM83321610 | R, METAL MK23K32FECZ.        |
| R435      | RM84752616 | R, METAL MK247K5FECZ.        |
| R436, 437 | RM82212618 | R, METAL MK222K1FECZ.        |
| R438      | RM82743612 | R, METAL MK2274KFECZ.        |
| R439      | RM83322614 | R, METAL MK233K2FECZ.        |
| R440      | RM84751612 | R, METAL MK24K75FECZ.        |
| R441, 442 | RM85621610 | R, METAL MK25K62FECZ.        |
| R443, 444 | RM84751612 | R, METAL MK24K75FECZ.        |
| R447      | RM84751612 | R, METAL MK24K75FECZ.        |
| R448      | RM84751612 | R, METAL MK24K75FECZ.        |
| R449      | RM88251610 | R, METAL MK28K25FECZ.        |
| R450      | RM88251610 | R, METAL MK28K25FECZ.        |
| R451, 452 | RM82211614 | R, METAL MK22K21FECZ.        |
| R453, 454 | RM86819611 | R, METAL MK268R1FECZ.        |
| R455      | RM86810619 | R, METAL MK2681RFECZ.        |
| R456, 457 | RM84751612 | R, METAL MK24K75FECZ.        |
| R458, 459 | RM83321610 | R, METAL MK23K32FECZ.        |
| R460, 461 | RM84751612 | R, METAL MK24K75FECZ.        |
| R462      | RM82212618 | R, METAL MK222K1FECZ.        |
| R463, 464 | RM61802056 | R, METAL VSH183              |
| R465      | RM81004613 | R, METAL MK2001MFECZ.        |
| R466      | RM81000619 | R, METAL MK2100RFECZ.        |
| R467, 468 | RM67502058 | R, METAL VSH753              |
| R469-472  | RM64702050 | R, METAL VSH473              |
| R473      | RM82213611 | R, METAL MK2221KFECZ.        |
| R474      | RM81004613 | R, METAL MK2001MFECZ.        |
| R475      | RM81002616 | R, METAL MK2010KFECZ.        |
| R476      | RM84752616 | R, METAL MK247K5FECZ.        |
| R479, 480 | RM65600053 | R, METAL VSH561              |
| R481, 482 | RM61001059 | R, METAL VSH102              |
| R483, 484 | RM64702050 | R, METAL VSH473              |
| R485, 486 | RM61000055 | R, METAL VSH101              |
| R488, 489 | RM81002616 | R, METAL MK2010KFECZ.        |
| R490      | RM84752616 | R, METAL MK247K5FECZ.        |
| R491      | RM84759611 | R, METAL MK247R5FECZ.        |
| C401      | CE51006477 | CAP, ELEC. 50BGF10M          |
| C402      | CE54705640 | CAP, ELEC. 25BGF470M         |
| C403      | CE51006477 | CAP, ELEC. 50BGF10M          |
| C404      | CE61005743 | CAP, ELEC. 16BGF100M         |
| C406      | CE51005679 | CAP, ELEC. 25BGF100M         |
| C407      | CM01009427 | CAP, MYLAR 103J 50V          |
| C408      | CE54707478 | CAP, ELEC. 50BGF4R7M         |
| L401      | LC23060009 | MPX FILTER TRL306            |
| L402      | LC23730003 | COIL TRL373                  |
| L403      | LM00000360 | MICRO INDUCTOR RLV312        |
| L404      | LC23730003 | COIL TRL373                  |
| R501      | RM81000619 | R, METAL MK2100RFECZ.        |
| R502      | RM81001612 | R, METAL MK2001KFECZ.        |
| R503-505  | RM84752616 | R, METAL MK247K5FECZ.        |
| R506      | RM81002616 | R, METAL MK2010KFECZ.        |
| R507      | RM84752616 | R, METAL MK247K5FECZ.        |
| R508-511  | RM82212618 | R, METAL MK222K1FECZ.        |
| R512      | RM84752616 | R, METAL MK247K5FECZ.        |
| R513      | RN31003080 | THICK FILM RS NETWORK A8104J |
| R521-530  | RM82212618 | R, METAL MK222K1FECZ.        |
| R531, 532 | RM81003610 | R, METAL MK2100KFECZ.        |
| R536      | RM81003610 | R, METAL MK2100KFECZ.        |

| SYMBOL    | PARTS NO.  | DESCRIPTION              |
|-----------|------------|--------------------------|
| R538      | RM84752616 | R, METAL MK247K5FECZ.    |
| R539, 540 | RM81002616 | R, METAL MK2010KFECZ.    |
| R541      | RM83322614 | R, METAL MK233K2FECZ.    |
| R542-545  | RM81002616 | R, METAL MK2010KFECZ.    |
| R546      | RM82211614 | R, METAL MK22K21FECZ.    |
| R547      | RM88251610 | R, METAL MK28K25FECZ.    |
| R548, 549 | RM81000619 | R, METAL MK2100RFECZ.    |
| R550      | RM88251610 | R, METAL MK28K25FECZ.    |
| R551, 552 | RM82740611 | R, METAL MK2274RFECZ.    |
| R553, 554 | RM86812616 | R, METAL MK268K1FECZ.    |
| C501      | CC31009465 | CAP, CERAMIC 0.01uF 50V  |
| C502      | CE01005167 | CAP, ELEC. 10uF 16V      |
| C503      | CC31009465 | CAP, CERAMIC 0.01uF 50V  |
| C504      | CE01338508 | CAP, ELEC. 0.33uF 50V    |
| C505, 506 | CC32211432 | CAP, CERAMIC 220P 50V    |
| C510, 511 | CC01512434 | CAP, CERAMIC 15P 50V     |
| C512      | CE04705103 | CAP, ELEC. 470uF 10V     |
| C513      | CC31009465 | CAP, CERAMIC 0.01uF 50V  |
| C514      | CE52208951 | CAP, ELEC. FYD0H224Z     |
| C515      | CE01005106 | CAP, ELEC. 100uF 10V     |
| C516-519  | CC31009465 | CAP, CERAMIC 0.01uF 50V  |
| C520      | CE51005540 | CAP, ELEC. 35BGF100M     |
| C521      | CM04709426 | CAP, MYLAR 473J 50V      |
| C522      | CE01338508 | CAP, ELEC. 0.33uF 50V    |
| C523, 524 | CE01007504 | CAP, ELEC. 1uF 50V       |
| Q501-516  | TR30000327 | TRANSISTOR 2SC536G-NP    |
| Q517      | TR50000127 | TRANSISTOR 3SK246-Y      |
| Q518      | TR30000509 | TRANSISTOR 2SC1570       |
| IC501     | IC00001759 | IC LC6522C-3433          |
| IC503     | IC00001346 | IC TC9157AP              |
| IC504     | IC00000482 | IC TD6104P               |
| D501-545  | DD80000021 | DIODE IN4148             |
| X501      | LF00000294 | CERAMIC FILTER CSB800J   |
| X502      | DD60000040 | CRYSTAL OSC. HC49U7.2MHZ |
| R601, 602 | RM81502613 | R, METAL MK2015KFECZ.    |
| R603      | RM83321610 | R, METAL MK23K32FECZ.    |
| R604      | RM81002616 | R, METAL MK2010KFECZ.    |
| R607-609  | RM81002616 | R, METAL MK2010KFECZ.    |
| R610      | RM84752616 | R, METAL MK247K5FECZ.    |
| R611      | RM88250617 | R, METAL MK2825RFECZ.    |
| R612      | RM86812616 | R, METAL MK268K1FECZ.    |
| R613, 614 | RM81002616 | R, METAL MK2010KFECZ.    |
| R615      | RM84752616 | R, METAL MK247K5FECZ.    |
| R616      | RM82741615 | R, METAL MK22K74FECZ.    |
| R617      | RM82211614 | R, METAL MK222K1FECZ.    |
| R618      | RM83323618 | R, METAL MK2332KFECZ.    |
| R619      | RM84752616 | R, METAL MK247K5FECZ.    |
| R620      | RM81002616 | R, METAL MK2010KFECZ.    |
| R621      | RM81003610 | R, METAL MK2100KFECZ.    |
| R622      | RM81002616 | R, METAL MK2010KFECZ.    |
| R623      | RM84752616 | R, METAL MK247K5FECZ.    |
| R624      | RM81000619 | R, METAL MK2100RFECZ.    |
| R625-627  | RM84752616 | R, METAL MK247K5FECZ.    |
| R628, 629 | RM81002616 | R, METAL MK2010KFECZ.    |
| R630      | RM84753610 | R, METAL MK2475KFECZ.    |
| R631      | RM85620616 | R, METAL MK2562RFECZ.    |
| R632      | RM83322614 | R, METAL MK233K2FECZ.    |
| R634      | RM85620616 | R, METAL MK2562RFECZ.    |
| C601      | CE51005540 | CAP, ELEC. 35BGF100M     |
| C602      | CE64706677 | CAP, ELEC. 25BGF47M      |
| C603      | CE02205449 | CAP, ELEC. 220uF 63V     |
| C604      | CE72205645 | CAP, ELEC. 25V 220uF HFS |
| C605      | CE74705256 | CAP, ELEC. 25V 470uF HFS |
| C606      | CE72205645 | CAP, ELEC. 25V 220uF HFS |
| C607      | CE74705256 | CAP, ELEC. 25V 470uF HFS |
| C608      | CE04706508 | CAP, ELEC. 47uF 50V      |
| C609      | CE04706259 | CAP, ELEC. 47uF 25V      |
| C610, 611 | CE51005679 | CAP, ELEC. 25BGF100M     |
| C612, 613 | CE51005679 | CAP, ELEC. 100uF 25V     |
| C614      | CE01005167 | CAP, ELEC. 100uF 16V     |

# Parts List

| SYMBOL     | PARTS NO.  | DESCRIPTION                         |
|------------|------------|-------------------------------------|
| C409       | CY24708425 | CAP, LAYER 50MSA474J                |
| C410       | CY21008428 | CAP, LAYER 50MSA104J                |
| C411, 412  | CM01009427 | CAP, MYLAR 103J 50V                 |
| C413       | CE01007504 | CAP, ELEC. 1uF 50V                  |
| C414, 415  | CE64706677 | CAP, ELEC. 25BGF47M                 |
| C416       | CS41000429 | CAP, STYROL 1000P 50V               |
| C417       | CM01009427 | CAP, MYLAR 103J 50V                 |
| C419       | CM04709426 | CAP, MYLAR 473J 50V                 |
| C420       | CS31510302 | CAP, POLY. 1500P 160V               |
| C423, 424  | CE51005679 | CAP, ELEC. 25BGF100M                |
| C427, 428  | CE51005679 | CAP, ELEC. 25BGF100M                |
| C430       | CS31510302 | CAP, POLY. 1500P 160V               |
| C431, 432  | CS33310304 | CAP, POLY. 3300P 160V               |
| C433       | CM01010429 | CAP, MYLAR 102J 50V                 |
| C434       | CM01009427 | CAP, MYLAR 103J 50V                 |
| C435, 436  | CE51006477 | CAP, ELEC. 50BGF10M                 |
| C436-440   | CS31011310 | CAP, POLY. 100P 160V                |
| C441, 442  | CE72205645 | CAP, ELEC. 220uF 25V HFS            |
| C443, 444  | CP61008321 | CAP, M.P 104K 100V                  |
| C445, 446  | CE74705256 | CAP, ELEC. 220uF 25V HFS            |
| C447, 448  | CP61008321 | CAP, M.P 104K 100V                  |
| C449, 450  | CE64706677 | CAP, ELEC. 25BGF47M                 |
| D401       | DD20000168 | DIODE RD5.6E                        |
| D402, 403  | DD80000021 | DIODE IN4148                        |
| D404       | DD20000168 | DIODE RD5.6E                        |
| D405, 406  | DD80000021 | DIODE IN4148                        |
| D407       | DD20000168 | DIODE RD5.6E                        |
| D408       | DD80000021 | DIODE IN4148                        |
| Q401, 402  | TR30000431 | TRANSISTOR 2SC1570                  |
| Q403, 404  | TR30000327 | TRANSISTOR 2SC536G-NP               |
| Q405       | TR10000254 | TRANSISTOR 2SA1345                  |
| Q406       | TR30000327 | TRANSISTOR 2SC536G-NP               |
| Q407       | TR30000492 | TRANSISTOR 2SC3399                  |
| Q408       | TR50000127 | TRANSISTOR 2SK246-Y                 |
| Q409       | TR30000431 | TRANSISTOR 2SC1570                  |
| Q410, 411  | TR10000102 | TRANSISTOR 2SA929                   |
| Q412       | TR30000431 | TRANSISTOR 2SC1570                  |
| Q413       | TR10000369 | TRANSISTOR 2SA1238                  |
| Q414       | TR30000649 | TRANSISTOR 2SC3065                  |
| Q415       | TR10000369 | TRANSISTOR 2SA1238                  |
| Q416       | TR30000649 | TRANSISTOR 2SC3065                  |
| Q417       | TR50000176 | TRANSISTOR 2SA366                   |
| Q418       | TR10000126 | TRANSISTOR 2SA608KF                 |
| Q419, 420  | TR30000327 | TRANSISTOR 2SC536G-NP               |
| Q421       | TR10000126 | TRANSISTOR 2SA608KF                 |
| IC401      | IC00002752 | IC LA3433                           |
| IC402-404  | IC00001693 | IC NE5532AN                         |
| IC405, 406 | IC00002478 | IC AD847JN                          |
| RY401      | LY00000253 | RELAY RY-12W $\Delta$               |
| X401       | LF00000403 | CERAMIC FILTER CSB456F15            |
| VR401      | RV40000101 | R, SEMI-FIXED VM6CKPV-1S-B<br>20KB  |
| VR402, 403 | RV40000113 | R, SEMI-FIXED VM6CKPV-1S-B<br>3.3KB |
| VR404, 405 | RV40000095 | R, SEMI-FIXED VM6CKPV-1S-B<br>47KB  |
| C615       | CE04706168 | CAP, ELEC. 47uF 16V                 |
| C616       | CE04707252 | CAP, ELEC. 4.7uF 25V                |
| D601       | DD80000021 | DIODE IN4148                        |
| D602       | DD20000193 | DIODE RD15E                         |
| D603       | DD10000391 | DIODE E-562                         |
| D604, 605  | DD20000193 | DIODE RV15                          |
| D606       | DD10000391 | DIODE E562                          |
| D607, 608  | DD80000021 | DIODE IN4148                        |
| D609       | DD20000016 | DIODE RD12E                         |
| D610-613   | DD80000021 | DIODE IN4148                        |
| D614       | DD10000068 | DIODE IN4003                        |
| Q601, 602  | TR30000509 | TRANSISTOR 2SC1570                  |
| Q603       | TR30000327 | TRANSISTOR 2SC536G-NP               |
| Q604       | TR10000047 | TRANSISTOR W/MICA 2SB631KE          |

| SYMBOL    | PARTS NO.  | DESCRIPTION                                  |
|-----------|------------|--|
| Q605      | TR10000126 | TRANSISTOR 2SA608KF                          |
| Q606      | TR40000069 | TRANSISTOR W/MICA 2SD600K                    |
| Q607, 608 | TR30000492 | TRANSISTOR 2SC3399                           |
| Q609      | TR10000126 | TRANSISTOR 2SA608KF                          |
| Q610, 611 | TR30000327 | TRANSISTOR 2SC536G-NP                        |
| Q612      | TR30000492 | TRANSISTOR 2SC3399                           |
| Q613      | TR10000126 | TRANSISTOR 2SA608KF                          |
| Q614      | TR10000059 | TRANSISTOR 2SB764E/F                         |
| Q615, 616 | TR30000327 | TRANSISTOR 2SC536G-NP                        |
| Q617      | TR10000059 | TRANSISTOR 2SB764E/F                         |
| Q618      | TR10000126 | TRANSISTOR 2SA608K                           |
| Q619      | TR30000327 | TRANSISTOR 2SC536G-NP                        |
| Q620      | TR10000254 | TRANSISTOR 2SA1345                           |
| Q621      | TR30000492 | TRANSISTOR 2SC3399                           |
| Q622      | TR30000327 | TRANSISTOR 2SC536G-NP                        |
| Q623      | TR30000492 | TRANSISTOR 2SC3399                           |
| Q624      | TR30000327 | TRANSISTOR 2SC536G-NP                        |
| IC601     | IC00000615 | IC NJM78M05                                  |
| IC602     | IC00000974 | IC NJM78M12                                  |
| IC603     | IC00001267 | IC NJM78M15                                  |
| IC604     | IC00000974 | IC NJM79M12                                  |
| IC605     | IC00000615 | IC NJM78M05                                  |
| RY601     | LY00000253 | RELAY RY12W $\Delta$                         |
| OTHERS    |            |  |
|           | AB00000675 | BOTTOM BOARD PT3-05C00T                      |
|           | AF30000188 | FRONT CHASSIS PT2-03B00T                     |
|           | AM00002037 | SUB CHASSIS PT2-04C00T                       |
|           | AS01000269 | RJ SIDE CHASSIS PK3-08D00T                   |
|           | PT00000345 | POWER TRANSFORMER<br>T-1042P02 $\Delta$      |
|           | CK00000035 | SPARK KILLER DE7150F472M $\Delta$            |
|           | BC00000143 | CYLINDER BUSH 4TVL-8#2<br>6F $\times$ 12H    |
|           | BC00000283 | CYLINDER BUSH 4TVL-8#1<br>6F $\times$ 10H    |
|           | BC00000751 | CYLINDER BUSH 4TVL-8#13<br>6F $\times$ 5H    |
|           | BC00000763 | CYLINDER BUSH 4TVL-8#14<br>6F $\times$ 7H    |
|           | BC00000775 | CYLINDER BUSH 4TVL-8#15<br>6F $\times$ 13.5H |
|           | FT00000205 | ZNS FOOT PK4-07A00T                          |
|           | SB00000820 | P.V.C SHIELD PLATE<br>C-4463A00T             |
|           | SP10006211 | P.C.B SUPPORT PK4-28A00T                     |
|           | SP40000838 | SHIELD COVER 4TTR-10A#2                      |
|           | AR30000209 | PRINTED REAR CHASSIS<br>TRP-611              |
|           | SA00002223 | AC INLET SOCKET 4TR-2786                     |
|           | VC00000050 | VOLTAGE SELECTOR C-4304A02<br>FS907K         |
|           | NP00002073 | NAME PLATE 120V N-756                        |
|           | NP00002097 | NAME PLATE 240V N-758                        |
|           | NP00002085 | NAME PLATE 230V N-757                        |
|           | AA30000424 | FRONT PANEL PT2-01A00                        |
|           | AW00000654 | RJ SENSOR WINDOW PT4-12A00T                  |
|           | AW00000678 | PANEL WINDOW PT4-06A00T                      |
|           | BU00001121 | PUSH BUTTON RING PK4-19B00T                  |
|           | KB20002966 | PUSH BUTTON 5F PT4-07A00                     |
|           | OM10001557 | LED TACT MOLD PT3-14A00T                     |
|           | OM10001569 | TACT MOLD PT3-15A00T                         |
|           | OM10001624 | ORNAMENTAL BAR PT4-09A00                     |
|           | BU00001285 | LED BUSH PT4-16A00T                          |
|           | BU00001327 | RUBBER BUSH C-4449A01                        |
|           | AG00000317 | RJ REMOTE CONTROL HANDSET<br>RHT-10AT        |

# Parts List

| SYMBOL | PARTS NO.  | DESCRIPTION                              |
|--------|------------|--|
|        | AU00001341 | TOP COVER PK3-05A00                      |
|        | KB20002978 | PUSH BUTTON PK4-16A00                    |
|        | OM10001545 | FL ORNAMENTAL PLATE<br>PT4-10B00T        |
|        | OM70000314 | FILTER BOARD C-4462A01T                  |
|        | OM70000326 | FILTER BOARD C-4462A02T                  |
|        | MN10003001 | OWNER'S MANUAL RHT-10                    |
|        | PL00001208 | STYROL PLATE (A) PK4-40A02T              |
|        | PL00001210 | STYROL PLATE (B) PK4-40A03T              |
|        | PL00001221 | STYROL PLATE (C) PK4-40A04T              |
|        | PL00001233 | STYROL PLATE (D) PK4-40A05T              |
|        | TN10004293 | INSIDE CARTON PT4-20A00                  |
|        | TN20002858 | SHIPPING CARTON PT4-211A00T              |
|        | TN30000022 | SIDE SHEET PK4-37B00                     |
|        | CD00000358 | AC POWER CORD C-4392A01<br>-U,C $\Delta$ |
|        | CD00000360 | AC POWER CORD C-4393A01<br>-H,E $\Delta$ |
|        | CD00000371 | AC POWER CORD C-4393A02<br>-K1 $\Delta$  |
|        | CD00000383 | AC POWER CORD C-4423A01<br>-G $\Delta$   |

# Schematic Diagram

## Schematic Diagram RHT-10

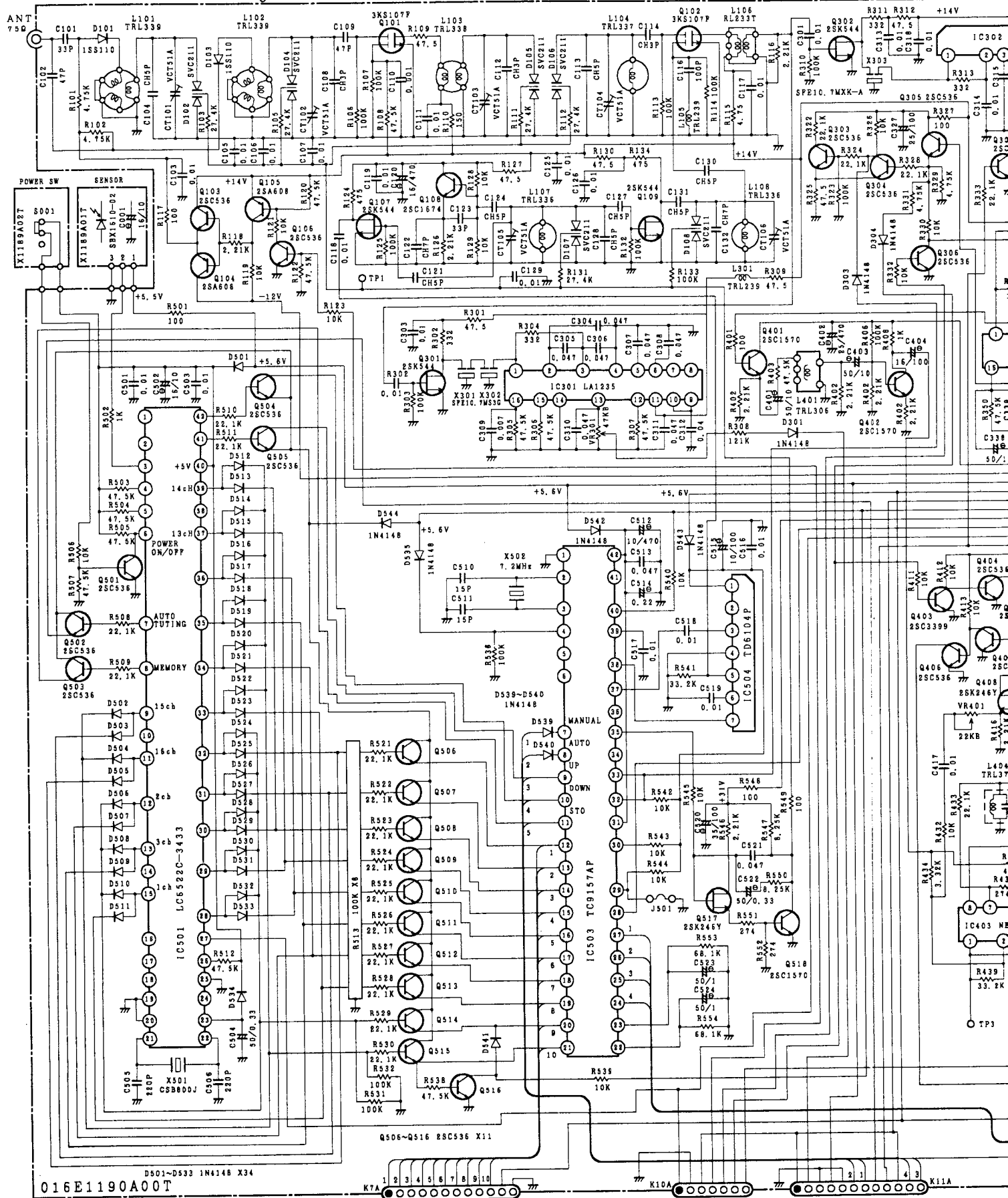

016E1190A00T

D501-D533 1N4148 X34

K7A

K10A

K11A

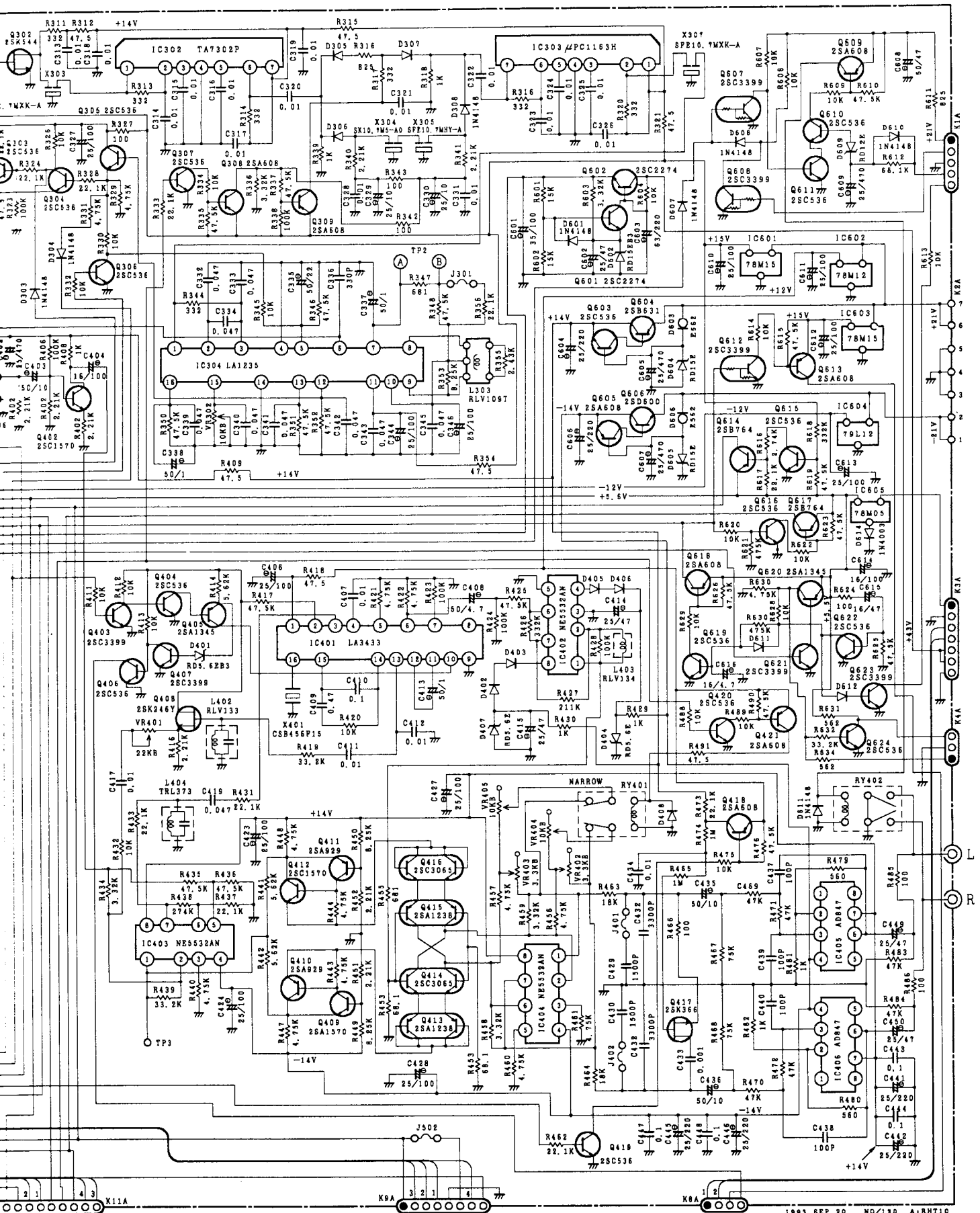

# Schematic Diagram

## Schematic Diagram RHT-10

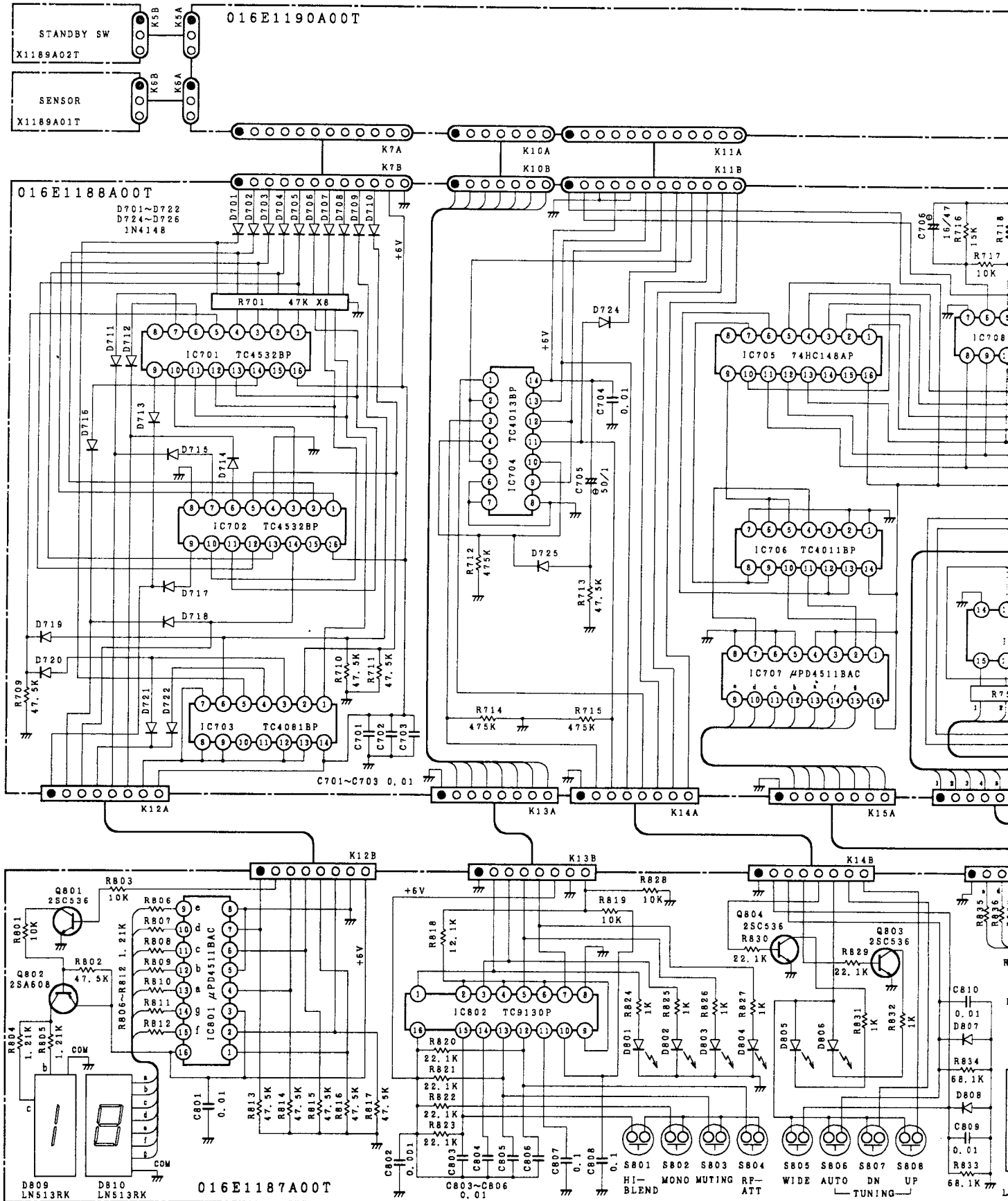

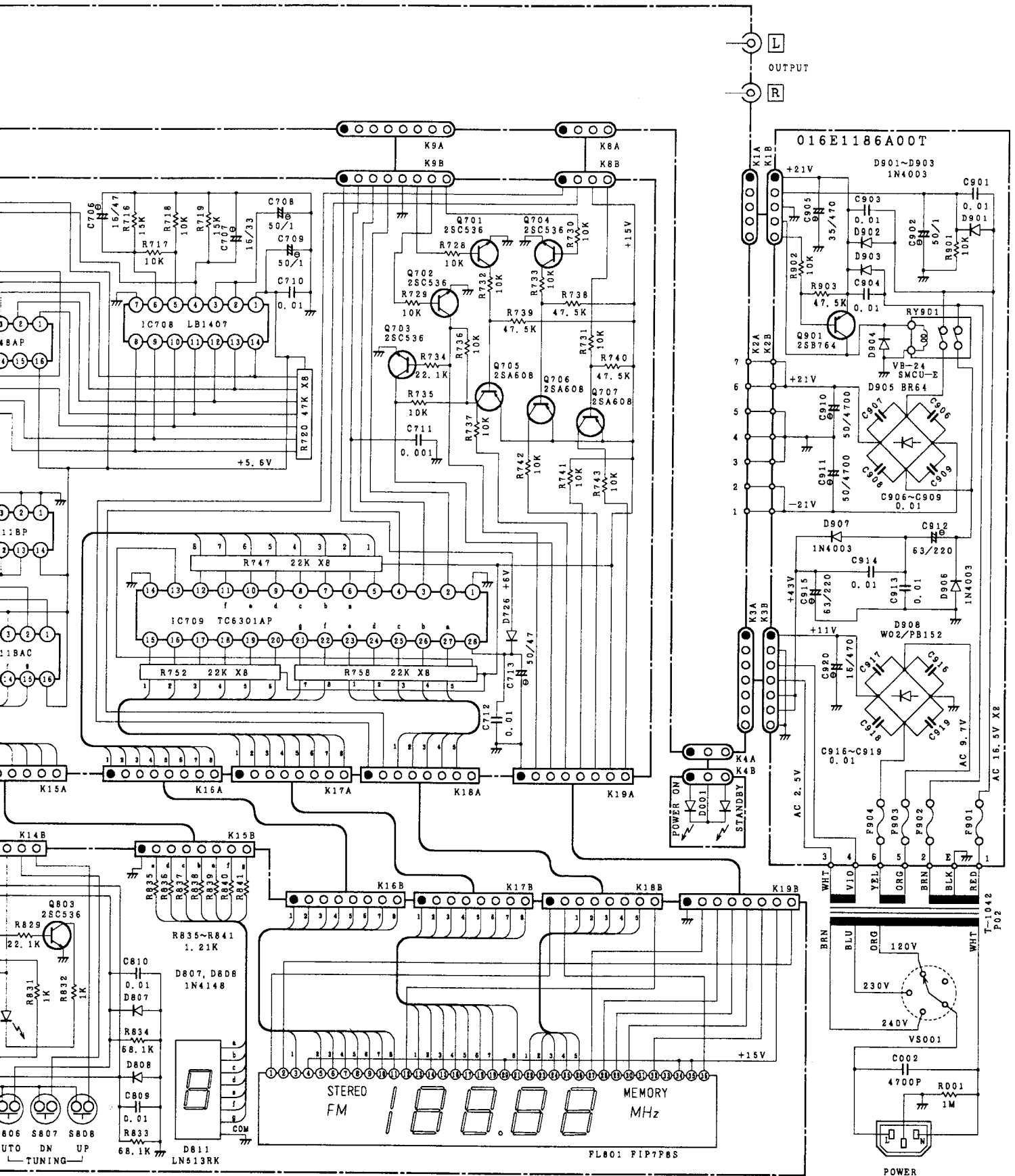

L  
R  
OUTPUT

016E1186A00T

D901~D903  
IN4003

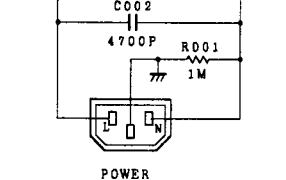
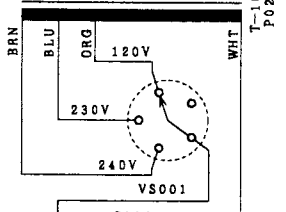
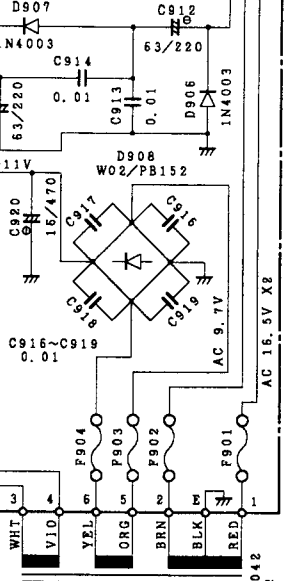
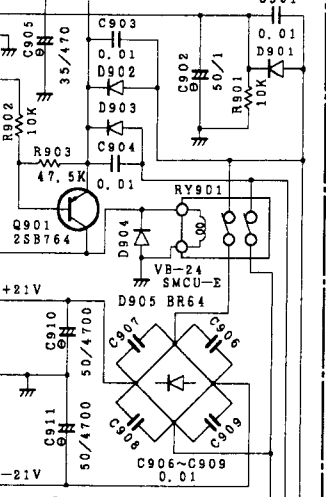

# Wiring Diagram

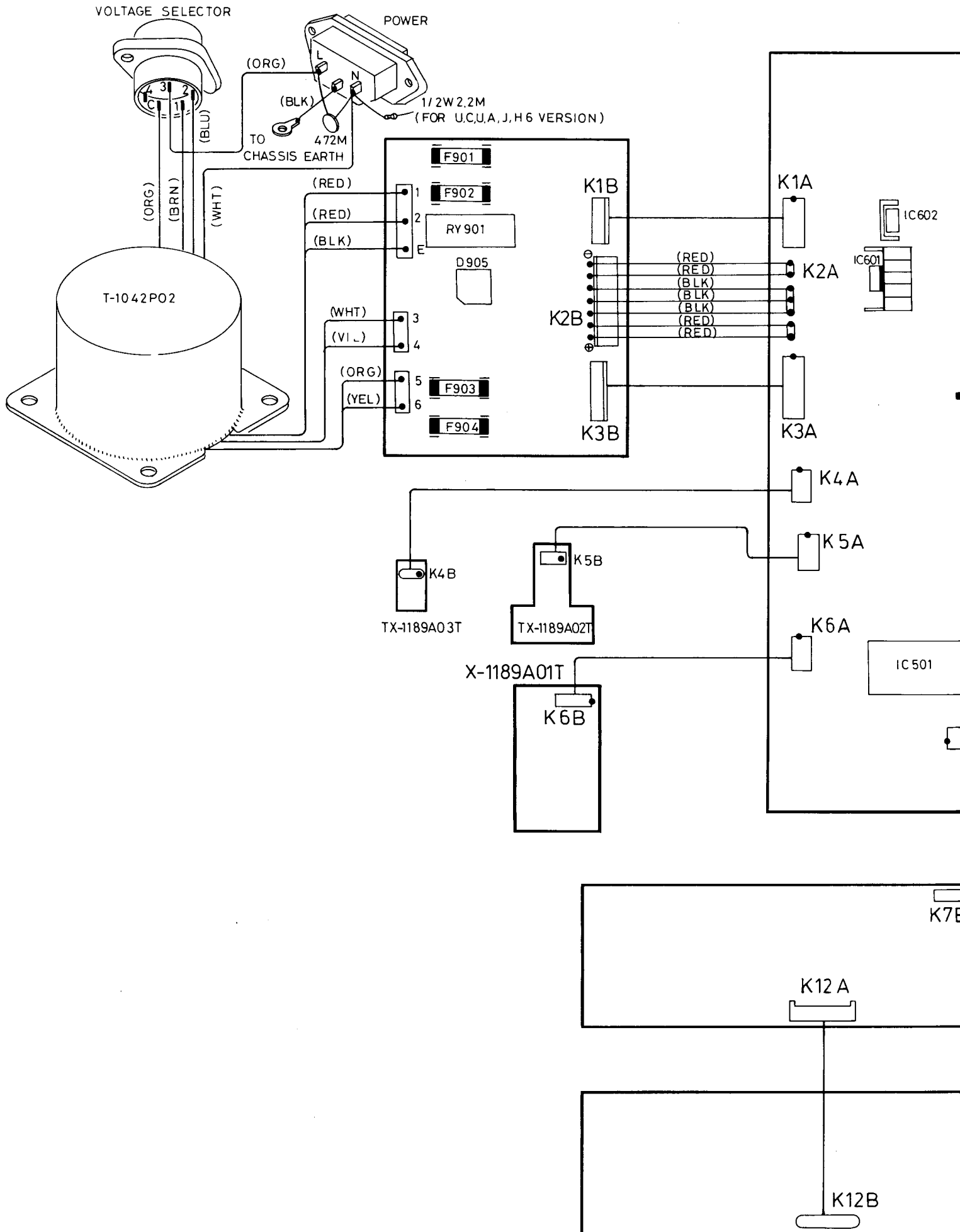



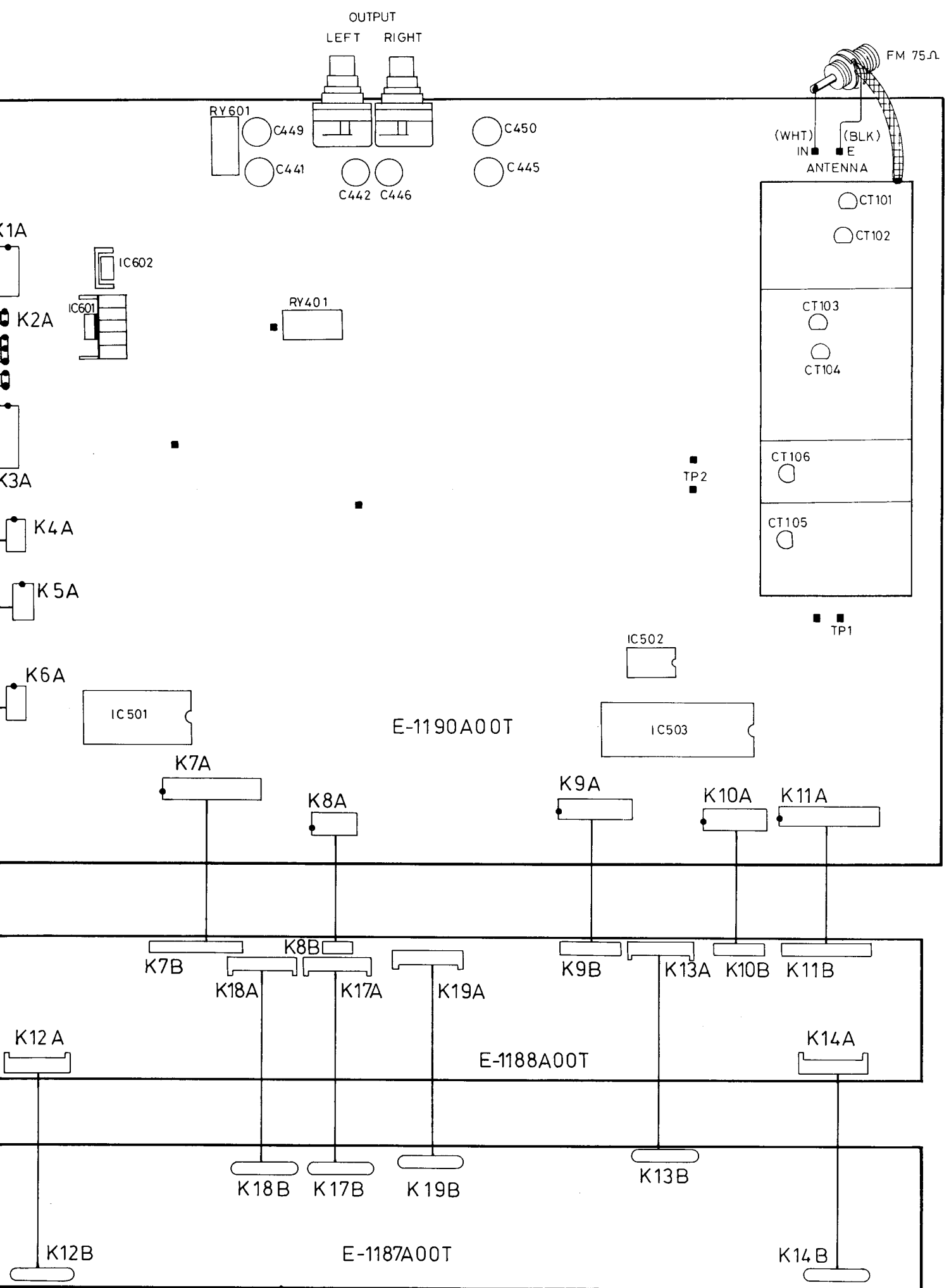

# Printed Circuit Boards

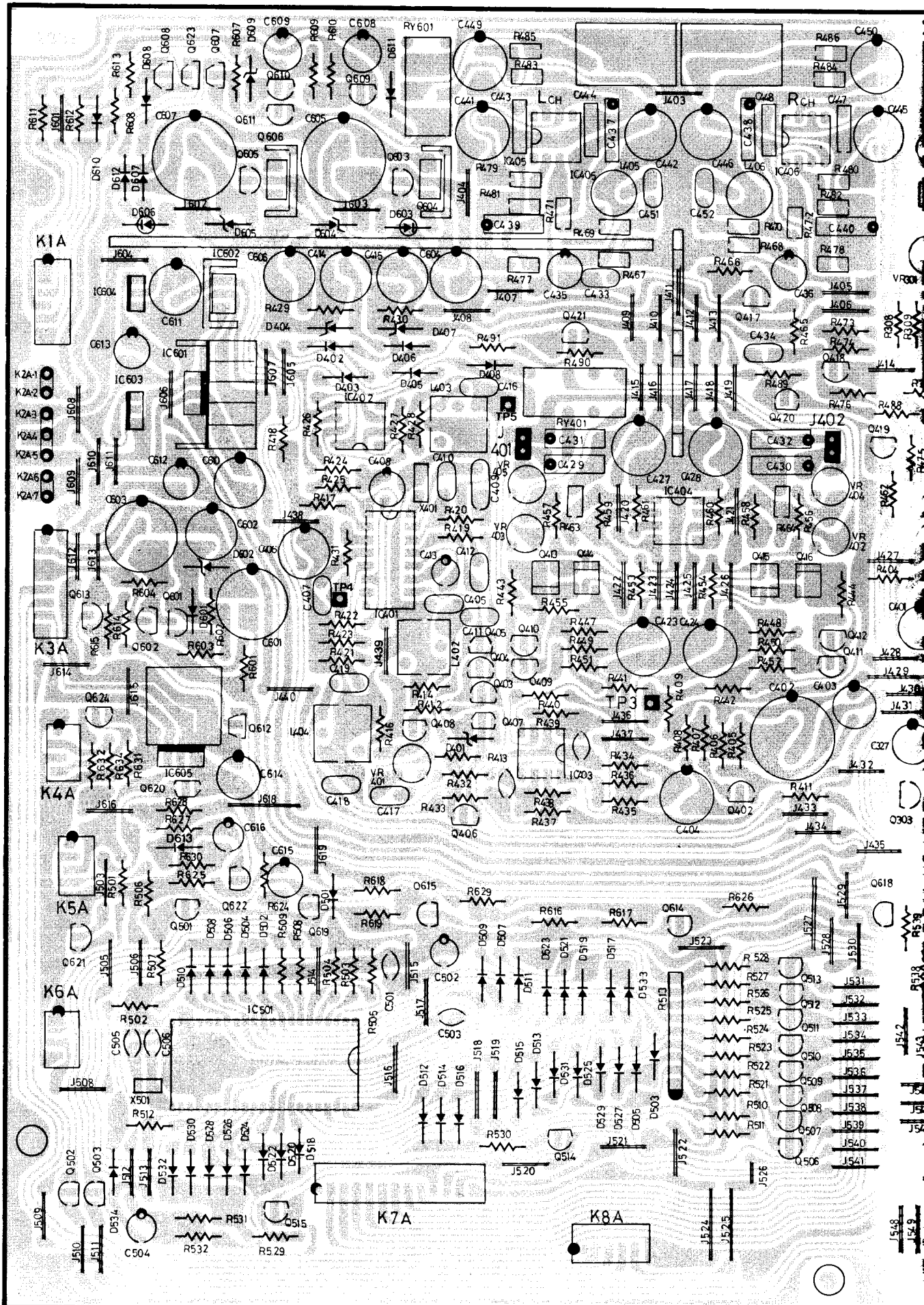

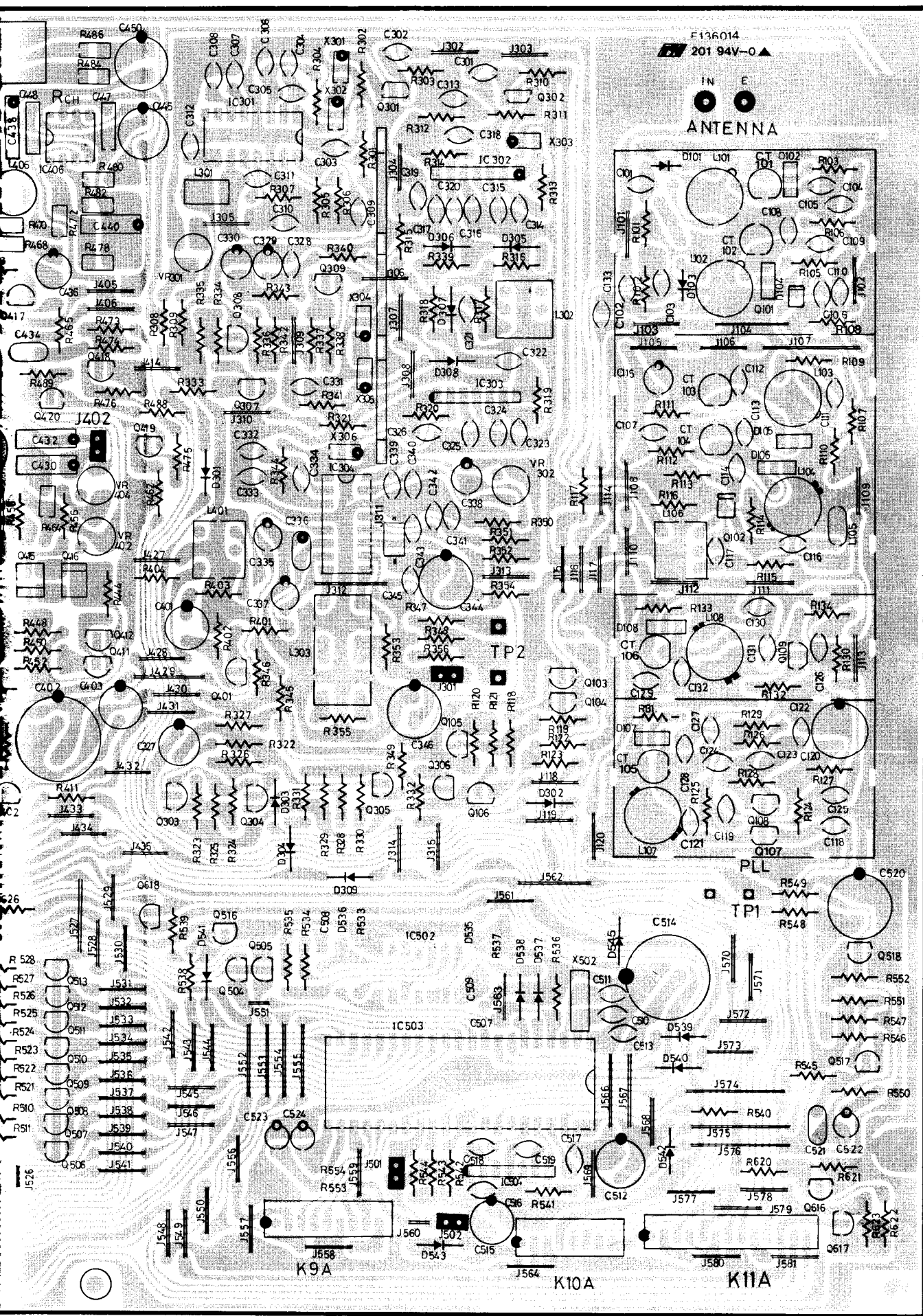

# Printed Circuit Boards

