

SABA Service-Instruction

T 233
T 234

SOFT OPERATING STEREO CASSETTE DECK CD 110
SOFT OPERATING STEREO CASSETTE DECK CD 11

CD 110
CD 11

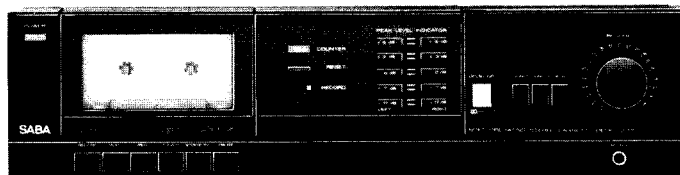

CD 110

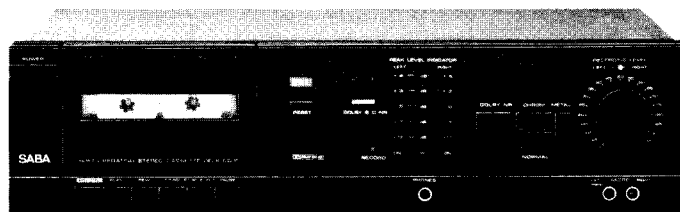

CD 11

Wichtige Hinweise

Die Sicherheit des Gerätes muß nach einer Reparatur oder Überprüfung erhalten bleiben. Es dürfen deshalb keine konstruktiven Merkmale des Gerätes sicherheitsmindernd verändert werden (z. B. müssen Abdeckungen ordnungsgemäß angebracht sein).

Ersatzteile müssen hinsichtlich ihrer Daten und ihrer Merkmale dem getauschten Teil entsprechen, damit die Sicherheit des Gerätes nicht vermindert wird. Verwenden Sie deshalb nur Original-Ersatzteile.

Important note

The unit must remain safe after repair or checking. Therefore, no design features of the unit may be altered which would result in a reduction of safety (e. g. covers must be properly replaced).

With regards to their data and technical features, spare parts must correspond with the replaced part, so as not to reduce the safety of the unit. Therefore, only use original spare parts.

Avvisi importanti











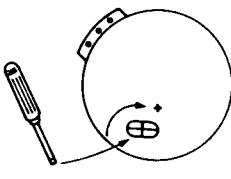
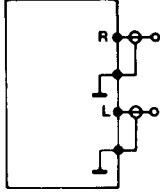
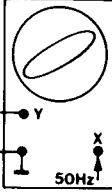

La sicurezza dell'apparecchio deve rimanere conservata anche dopo una riparazione o un controllo. Perciò non è permesso di variare connotati costruttivi dell'apparecchio in modo che non garantiscono la sicurezza originaria (p. es. gli schemi di protezione devono essere fissati a regola d'arte).

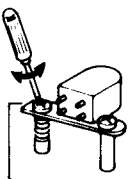
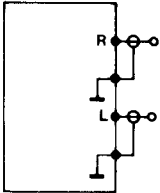
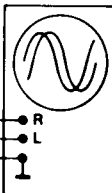
I pezzi di ricambio devono corrispondere al pezzo da sostituire nei loro dati e nei loro connotati per garantire la stessa sicurezza dell'apparecchio. Usate perciò solo ricambi originali.

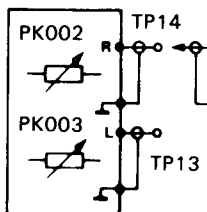
Recommandations importantes

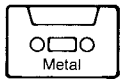
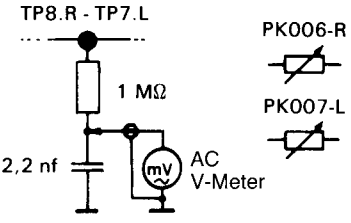
L'appareil doit remplir les mêmes conditions de sécurité après une réparation ou une révision. Aucune caractéristique de construction de l'appareil ne doit donc être modifiée de telle sorte que la sécurité de l'appareil en soit diminuée (par ex., les couvercles doivent être remis en place correctement).

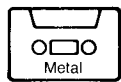
Les caractéristiques et les propriétés des pièces de rechange doivent coïncider avec celles de la pièce qui est remplacée afin de ne pas réduire la sécurité de l'appareil. N'utilisez donc que des pièces de rechange d'origine.

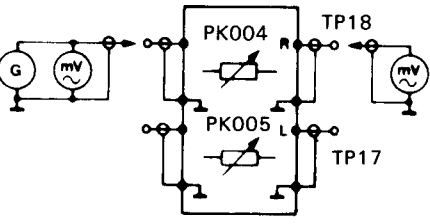
<p>1</p> <p>Bandzug Tensione del nastro Tape tension Tension de bande</p>			<p>«→»</p> <p>40 g/cm <math>\mathcal{M}</math> <math>< 70</math> g/cm</p> <p>«←>»</p> <p>80 g/cm <math>\mathcal{M}</math> <math>< 160</math> g/cm</p>
<p>2</p> <p>Bandgeschwindigkeit Velocità del nastro Tape speed Vitesse de défilement</p>	  <p>f = 50 Hz</p>	 	 <p>50Hz</p>
<p>3</p> <p>Tonkopfeinstellung Regolazione di azimut Azimuth adjustment Réglage d'azimut</p>	  <p>f = 10 kHz (6,3 kHz)</p>	 	<p>PR = PL</p> 
<p>4</p> <p>Wiedergabeempfindlichkeit Sensibilità di riproduzione Playback sensitivity Gain en lecture</p>	  <p>400 Hz</p>		<p>Vs = 530 mV 0 dB ± 0,5</p>
<p>5</p> <p>Vormagnetisierung Corrente di premagnetizzazione Bias adjustment Courant de prémagnétisation</p>	 	<p>TP8.R - TP7.L</p> 	<p>V = 32 mV ± 0,5 dB</p>
<p>6</p> <p>Aufnahmeempfindlichkeit Sensibilità registrazione Record sensitivity Gain en enregistrement</p>	   <p>Ve = 50 mV ± 1 dB f = 400 Hz</p>		<p>V = 110 mV ± 0,5 dB</p>

SABA				
CD 11		T 234		3
Pos.	No.	Bezeichnung	Description	
		<u>Grund Platine</u>	<u>Main Board</u>	
3531	171 000	A1	TK 001	RC4558P
3531	227 000	AK	IK 002	MC/R12CT oder SFC2812EC
4900	040 462	AF	TK 003,004	BC651C
352R	509 000	AB	TK 071,010	BC349C
352R	501 000	AB	TK 011,012	BC338-40
352R	461 000	AH	TK 013	BD135
352R	515 000	AC	TK 014,015	BC558C
4900	056 407	AH	LJ 001,002	23 mH
4900	056 117	AG	LJ 003,004	36mH
4900	056 124	AM	LK 001,002	Filter
4900	056 126	AH	LK 003	Filter
4900	056 124	AG	LK 004,005	6,8mH
4900	056 430	AC	BK 064	20 Ohm/5%/1W

4900 056 360	AD	PK002...005	Pot1 22 K
4900 056 129	AD	PK 006,007	Pot1 100 K
4900 056 410	AW	SK 002	Tastensatz Dolby, NH, Normal, Chrom Metal
4900 056 131	AM	SK 003	Schalter Ein-Aus
4900 056 411	AL	SK 004	Schalter Aufn./ Wdg.
4900 056 236	AI	BK 004	Buchse DIN 7 pol.
<u>Dolby Platine</u>			
4900 056 116	BE	LJ 050	TEA0665
4900 056 117	AG	LJ 050	36 mH 5%
4900 018 366			
A = Austauschteil		R = Reparatur-Umtauschteil (kein Voraussatz möglich)	
⚠ Sicherheitsbauteil		⚠ Componente di sicurezza	
Bei Ersatz nur Originalteile verwenden		In caso di sostituzione usare componenti originali	
When repairing, use original parts only		Subject to modification without notice!	
Modifications réservées!		Modifications réservées!	

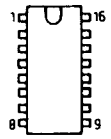

TA7629P

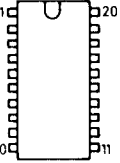

U2068

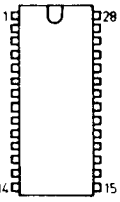

TEA0665

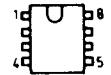

LM393
RC4558P
U267B



TLHG200
TLHR6200

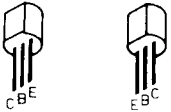

BC338 BC651C
BC548C BC558C BC550C

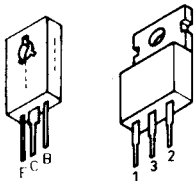

BD135 MC7812CT
SFC2812EC

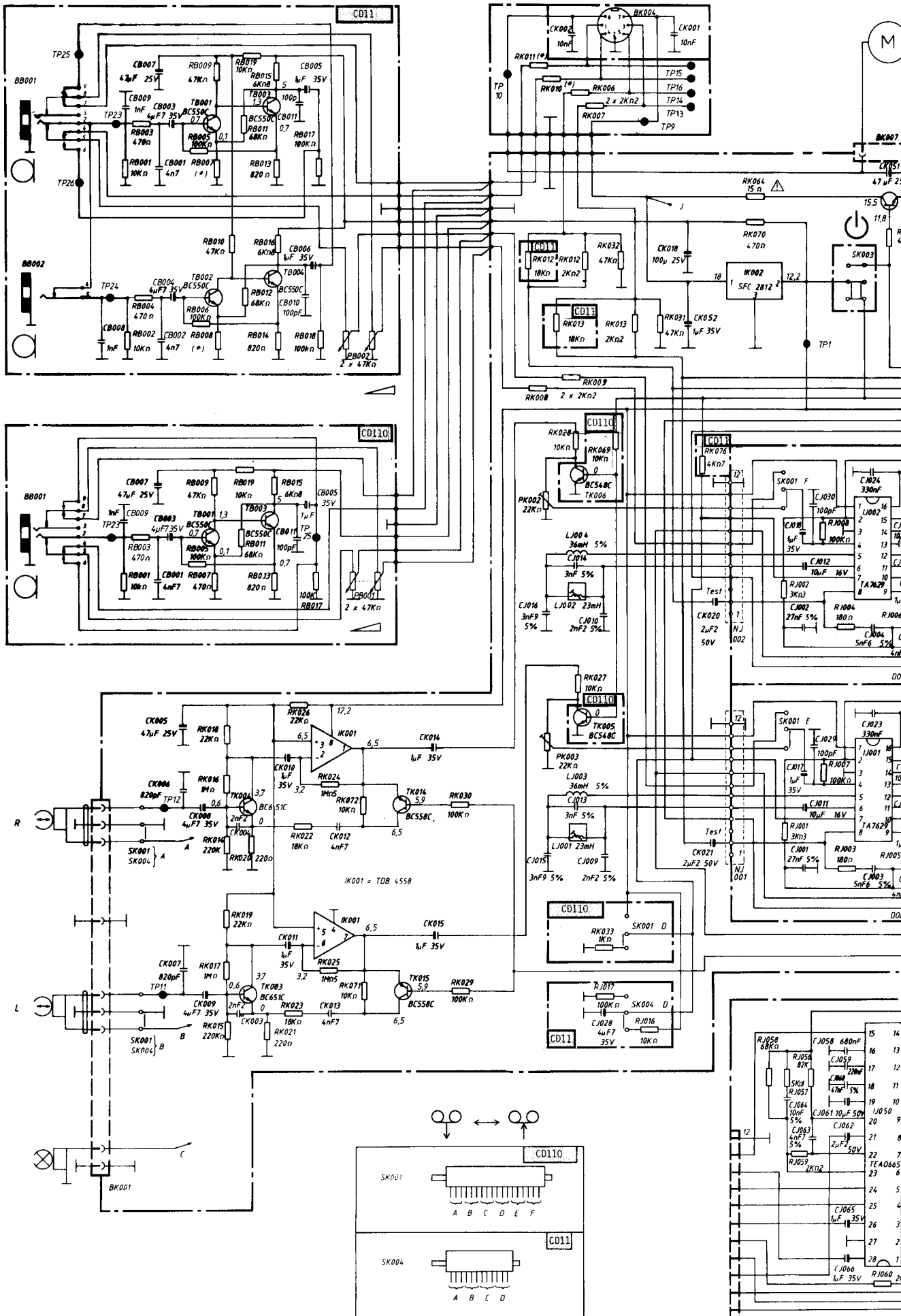

Platine bestückt je nach Ausführung CD 110/CD 11
 Piastra montati secondo le versioni degli apparecchi CD 110/CD 11
 PCB's inserted according to the versions CD 110/CD 11
 Platines câblés selon les versions d'appareils CD 110/CD 11

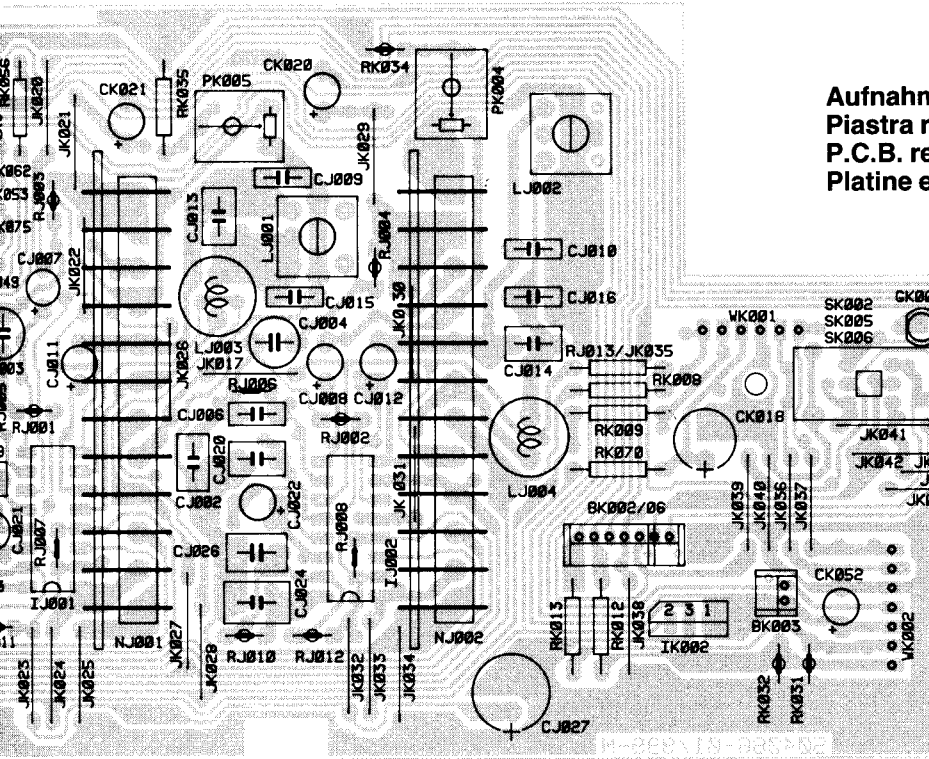

Aufnahme/Wiedergabe-Entzerrerplatte
 Piastra registrazione/riproduzione
 P.C.B. record/playback
 Platine enregistrement/lecture

Anzeigeplatte
 Piastra indicatore
 P.C.B. indicators
 Platine voyants

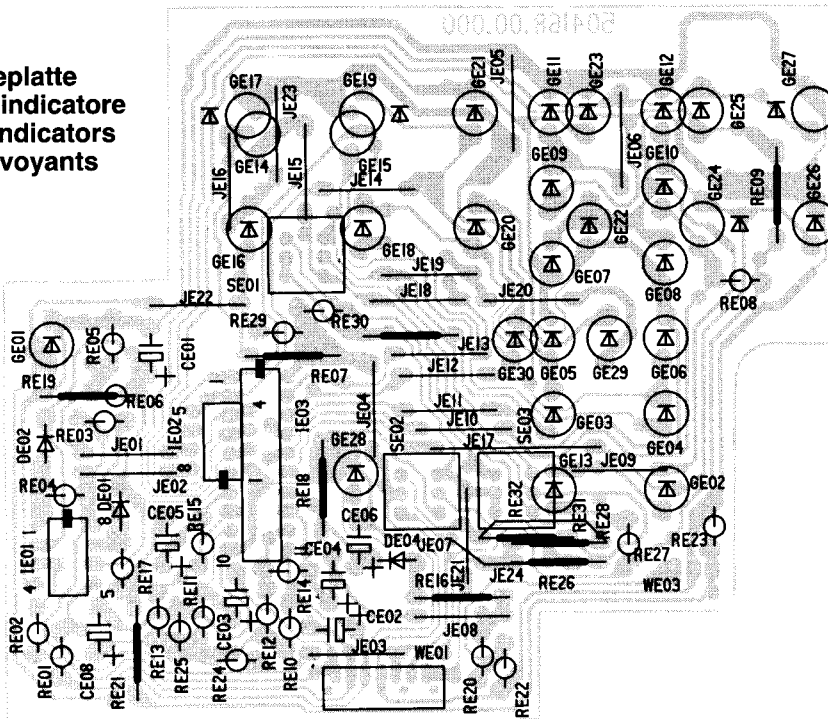

Dolby-Platte
 Piastra Dolby
 P.C.B. Dolby
 Platine Dolby

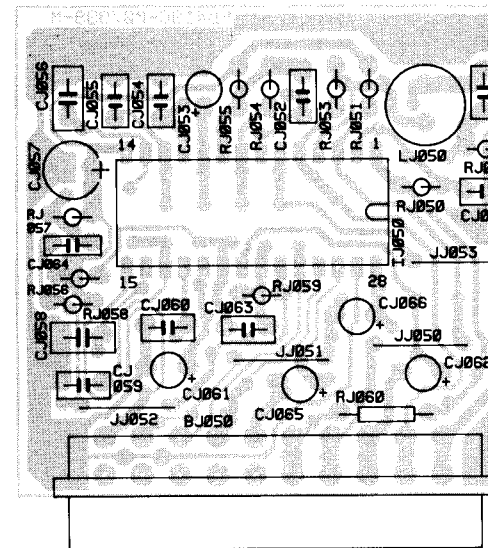

Mikrofonbuchsen/Aussteuerungsregler-Platte
 Piastra prese microfoni/comandi del livello di registrazione
 P.C.B. micro-jack/level control
 Platine prises micro/pot. niveau d'enregistrement

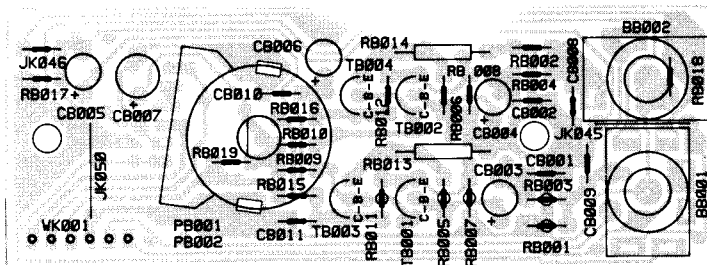

Buchsenplatte · Piastra presa
 P.C.B. socket · Platine prise

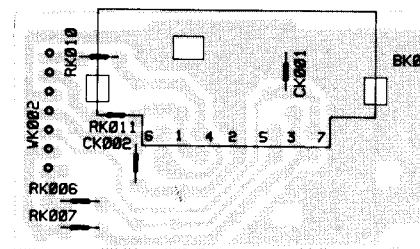

SABA Ersatzteilliste		CD 110	T 233	Seite 1
Position	Teil	Bemerkungen	Best.-Nr.	Preisgruppe
	Verpackung kpl.		4900 056 681	AM
	Zubehör			
	DIN-Kabel 7 pol.		4900 056 758	BA
	Gehäuse			
	Frontplatte		4900 056 682	BB
	Anzeigefenster		4900 056 756	AK
	Cassettenklappe		4900 056 690	AO
	Fenster		4900 056 689	AK
	Taste			
	POWER		4900 056 683	AH
	DOLBY NR		4900 056 757	AC
	NORM-CHROM-METAL		4900 056 686	AC
	RECORD...PAUSE		4900 056 684	AC
	Knopf RECORD Aufnahmepegel		4900 056 687	AG
	Gehäuseabdeckung		4900 056 688	AT
	Gehäusefuß		4900 056 627	AB
	Laufwerk			
1	Zahnrad		4900 056 704	AF
2	Drehfeder		4900 056 705	AA
3	Hebel Pause		4900 056 706	AC
4	Hebel Tastenentriegelung		4900 056 707	AC
5	Schwungrad		4900 056 708	AR
6	Antriebsriemen		4900 056 694	AG
7	Druckfeder		4900 056 709	AA
8	Pausensperre		4900 056 710	AC
9/51	Druckfeder		4900 056 711	AA
10	Druckfeder		4900 056 712	AA
11	Grundplatte Cassettenführung	rechts	4900 056 713	AL
12	Zählwerkriemen		4900 056 693	AG
13	Drehfeder		4900 056 714	AB
14	Zählwerk		4900 056 691	AS
15	Rasthebel f. Cass.Klappe		4900 056 715	AG
16	Hebel Laufwerksteuerung		4900 056 719	AC
17	Drehfeder		4900 056 717	AB
18	Blattfeder		4900 056 718	AC
19	Hebel für Tasten		4900 056 719	AC
20	Zugfeder		4900 056 720	AA
21	Zwischenrolle		4900 056 721	AF
22	Andruckrolle		4900 056 692	AI
23/56	Zugfeder		4900 056 722	AA
24	Drehfeder		4900 056 723	AB
25	Zugfeder		4900 056 724	AA
26	Drehfeder		4900 056 725	AA
27	Druckfeder		4900 056 726	AA
28	Tonkopf		4900 056 697	BC
29	Kopftträger		4900 056 727	AD
30	Löschkopf		4900 056 696	AP
31	Drehfeder		4900 056 728	AC
32	Dämpfer kpl. f. Cassettenfach		4900 056 729	AK
33	Cassettenhalter		4900 056 730	AN
34	Blattfeder		4900 056 731	AB
35	Aufwickelbandteller		4900 056 699	AI
36	Abwickelbandteller		4900 056 698	AC
37	Druckfeder		4900 056 732	AA
38	Kunststofflager		4900 056 733	AC
39	Rolle, Schneller Vor- u. Rücklauf		4900 056 734	AC
40	Druckfeder		4900 056 735	AA
41	Bandtellergrundplatte		4900 056 736	AL

SABA Ersatzteilliste		CD 110	T 233	Seite 2
Position	Teil	Bemerkungen	Best.-Nr.	Preisgruppe
42	Aufnahmesperrhebel		4900 056 737	AC
43	Zugfeder		4900 056 738	AB
44	Rutschkupplung		4900 056 739	AN
45	Zahnrad		4900 056 740	AC
46	Zahnrad		4900 056 741	AC
47	Laufwerk		4900 056 742	AC
48	Drehfeder		4900 056 761	AB
49	Grundplatte Cassettenführung	links	4900 056 743	AH
50	Druckfeder		4900 056 744	AA
53	Antriebsriemen		4900 056 745	AA
54	Antriebsriemen		4900 056 746	AK
55	Gummidurchführung		4900 056 747	AA
56	Tonwellengegenlager		4900 056 748	AC
57	Motor		4900 051 017	BL
	Riemenscheibe f. Motor		4900 056 760	AC
58	Zugfeder		4900 056 749	AB
	Aussteuerungsanzeige-Platine			
	IE 01	LM393	4900 056 702	AL
	IE 02	U267B	4900 046 445	AN
	BE 01,02	1N4148	4900 216 000	AA
	GE 01,09,11	LED TLHR6200 (rot)	4900 056 752	AF
	GE 03,05,07	LED TLHG6200 (grün)	4900 056 753	AF
	Poti Platine			
	TB 01,03	BC550C	3528 512 000	AF
	PB 01	Poti 2x47 K Aufnahmepegel	4900 056 700	AM
	BB 01	Mikrofonbuchse 6,35 mm	4900 056 404	AM
	Grund-Platine			
	IJ 01,02	TA7629P	4900 037 462	AT
	IK 01	RC4558P	3531 171 000	AI
	LK 02	MC7812CT	3531 227 000	AM
	TK 03,04	BC651C	4900 040 462	AF
	TK 05...10	BC548C	3528 509 000	AR
	TK 11,12	BC338-40	3528 501 000	AG
	TK 13	8D135	3528 461 000	AH
	TK 14,15	BC558C	3528 515 000	AC
	DK 01	1N4148	3512 216 000	AA
	GK 01	LED TLHR 6205 (rot)	4900 056 613	AG
	LJ 01,02		4900 056 407	AH
	LJ 03,04		4900 056 408	AG
	LK 01,02		4900 056 125	AM
	LK 03		4900 056 126	AH
	LK 04,05	Poti 22 K	4900 056 174	AG
	PK 02...05	Poti 100 K	4900 055 960	AD
	PK 06, 07	Poti 100 K	4900 056 129	AD
	SK 01	Schalter Aufn.-Wdg.	4900 056 701	AL
	SK 02	Schalter 4 x	4900 056 410	AX
		Dolby-Norm-Chrom-Metal		
	SK 07	Schalter Ein-Aus	4900 056 131	AM
	BK 04	DIN-Buchse 7 pol.	4900 056 236	AI
	4900 018 339			

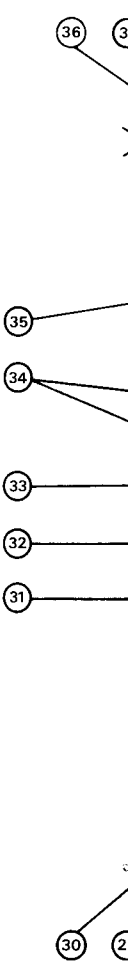

SABA		CD 11	T 234	1
Pos.	No.	Bezeichnung	Description	
	4900 056 381	AM Verpackung kpl.	Packing cpl.	
		Zubehör	Accessory	
	4900 056 758	BA DIN-Kabel 7 pol.	DIN-Cable 7 pin	
		Gehäuse	Cabinet	
	4900 056 382	BA Frontplatte	Front Panel	
	4900 056 426	AN Anzeigefenster (Zierblende)	Indicator Window	
	4900 056 394	AT Cassettenklappe	Cassette Door	
	4900 056 730	AN Cassettenhalter	Cassette Holder	
	4900 056 731	AB Blattfeder	Spring	
	4900 056 729	AK Dämpfer	Damper	
	4900 056 728	AC Drehfeder	Spring	
		Taste	Button	
	4900 056 303	AG Ein-Aus	Power	
	4900 056 386	AE Dolby blau	Dolby blue	
	4900 056 387	AF Dolby NR	Dolby NR	
	4900 056 307	AE Chrom, Norm., Metal	Chrom, Norm., Metal	
	4900 056 684	AC Aufnahme...Pause	Record...Pause	
		Knopf	Knob	
	4900 056 389	AG Aufnahmepegel links	Rec.Level left	
	4900 056 390	AG Aufnahmepegel rechts	Rec.Level right	
	4900 056 391	AS Gehäuseabdeckung	Top Cover	
	4900 056 319	AB Gehäusefuß	Foot	
		Chassis	Chassis	
	4900 056 416	AF Hebel f. Taste Ein-Aus	Lever f. Button Power	
	4900 056 419	AA Druckfeder	Spring	
	4900 056 414	AF Hebel f. Schalter Aufn.-Wdg.	Lever f. Switch Rec Play	
	4900 056 418	AB Zugfeder	Spring	
	4900 056 417	AE Achse f. Taste Dolby...Metal	Axle f. Button Dolby...Metal	
		Laufwerk	Mechanism	
1	4900 056 704	AF Zahnrad	Gear	
2	4900 056 705	AA Drehfeder	Spring	
3	4900 056 706	AC Hebel Pause	Auto Lock Arm	
4	4900 056 707	AC Hebel Tastenentriegelung	Auto Arm	
5	4900 056 708	AR Schwungrad	Flywheel	
6	4900 056 694	AG Riemen Antrieb	Belt	
7	4900 056 709	AA Druckfeder	Spring	
8	4900 056 710	AC Pausensperre	Pause Cam	
9	4900 056 711	AA Druckfeder	Spring	
10	4900 056 712	AA Druckfeder	Spring	
11	4900 056 422	AK Grundplatte f. Schieber	Lever Holder Pause	
		Pause...Rücklauf	RF	
12	4900 056 693	AG Riemen Zählwerk	Counter Belt	
13	4900 056 714	AB Drehfeder	Spring	
14	4900 056 691	AS Zählwerk	Counter	
15	4900 056 423	AG Rasthebel f. Cassettenklappe	Eject Lever	
16	4900 056 716	AC Hebel Laufwerksteuerung	Lock Arm	
17	4900 056 717	AB Drehfeder	Spring	
18	4900 056 719	AC Hebel f. Tasten	Button Lever	
19	4900 056 692	AI Andruckrolle	Pinch Roller	
20	4900 056 722	AA Zugfeder	Spring	
21	4900 056 723	AB Drehfeder	Spring	
22	4900 056 724	AA Zugfeder	Spring	
23	4900 056 725	AA Drehfeder	Spring	
24	4900 056 401	BC Tonkopf	Rec Play Head	

SABA		CD 11	T 234	2
Pos.	No.	Bezeichnung	Description	
25	4900 056 696	AF Löschkopf	Erase Head	
26	4900 056 726	AA Druckfeder	Spring	
27	4900 056 727	AD Kopftträger	Head Base	
28	4900 056 721	AF Zwischenrad	Play Idler	
29	4900 056 720	AA Zugfeder	Spring	
30	4900 056 424	AB Blattfeder	Pack Spring	
31	4900 056 737	AC Aufnahmesperrhebel	Rec. Sensor	
32	4900 056 699	AI Aufwickelbandteller	Take up Reel	
33	4900 056 698	AG Abwickelbandteller	Supply Reel	
34	4900 056 732	AA Druckfeder	Spring	
35	4900 056 733	AC Kunststofflager	Auto Clutch	
36	4900 056 734	AC Rad Schnelllauf	FF Gear	
37	4900 056 735	AA Druckfeder	Spring	
38	4900 056 736	AL Bandtellergrundplatte	Reel Base	
39	4900 056 738	AB Zugfeder	Spring	
40	4900 056 425	AM Rutschkupplung	Clutch Arm Ass'y	
41	4900 056 740	AC Zahnrad	Auto Gear	
42	4900 056 741	AC Zahnrad	Auto Cam Gear	
43	4900 056 742	AC Zahnrad	Auto Pulley	
44	4900 056 761	AB Drehfeder	Spring	
45	4900 056 743	AH Grundplatte f. Schieber	Lever Holder Rec.	
		Aufn.Wdg.	Play	
46	4900 056 744	AA Druckfeder	Spring	
47	4900 056 711	AA Druckfeder	Spring	
48	4900 056 722	AA Zugfeder	Spring	
49	4900 056 745	AH Riemen Antrieb	FF Belt	
50	4900 056 746	AK Riemen Motor-Schwungrad	Drive Belt	
51	4900 056 748	AC Gegenlager Schwungrad	Capstan Holder	
52	4900 056 747	AA Gummilager Motor	Motor Cushion	
53	4900 051 017	BL Motor	Motor	
	4900 056 760	AC Riemenscheibe f. Motor	Pulley f. Motor	
54	4900 056 749	AB Zugfeder	Spring	
		Aussteuerungsanzeige	Level Indicator	
		Platine	Board	
	4900 056 413	AU IE 003 U2068B		
	4900 050 647	AC DE 001,004 BAT41		
	4900 056 753	AF GE 002...008,013,014		
		LED grün TLHG6200		
	4900 056 752	AF GE 009...012, 028		
		LED rot TLHR6200		
	4900 056 312	AL SE 001 Schalter Dolby B/C	SE 001 Switch Dolby B/C	
		Kopfhörer Buchsen Platine	Headphones Jack Board	
	4900 056 412	AI BE 003 Buchse Kopfhörer	BE 003 Headphones Jack	
		Aussteuerungs-Regler	Rec. Level VR Board	
		Platine		
	3528 512 000	AF TB 001...004 BC550C		
	4900 056 409	AR PB 002 Poti 2x47K Aufnahmepegel	PB 002 VR 2x47K Record Level	
	4900 056 404			

Laufwerk CD 110 · Meccanismo di scorrimento CD 110 · Mech.-Ass'y CD 110 · Systemé d'entraînement CD 110

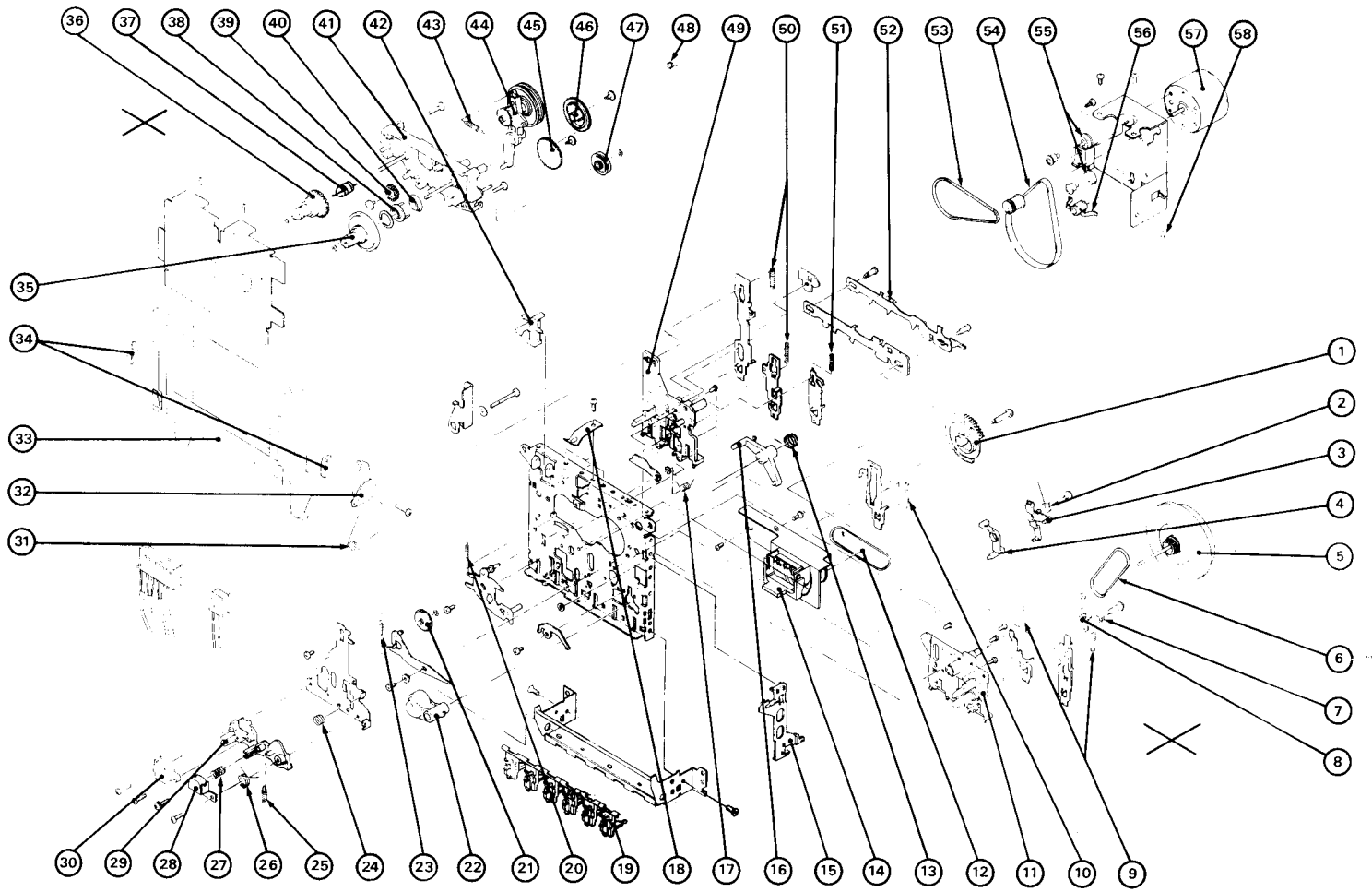

Laufwerk CD 11 · Meccanismo di scorrimento CD 11 · Mech.-Ass'y CD 11 · Systemé d'entraînement CD 11

