

FM AM STEREO TUNER MT 110

MT 110

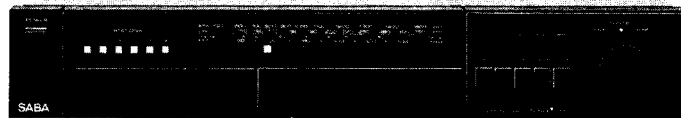

Wichtige Hinweise

Die Sicherheit des Gerätes muß nach einer Reparatur oder Überprüfung erhalten bleiben. Es dürfen deshalb keine konstruktiven Merkmale des Gerätes sicherheitsmindernd verändert werden (z. B. müssen Abdeckungen ordnungsgemäß angebracht sein).

Ersatzteile müssen hinsichtlich ihrer Daten und ihrer Merkmale dem getauschten Teil entsprechen, damit die Sicherheit des Gerätes nicht vermindert wird. Verwenden Sie deshalb nur Original-Ersatzteile.

Avvisi importanti

La sicurezza dell'apparecchio deve rimanere conservata anche dopo una riparazione o un controllo. Perciò non è permesso di variare connotati costruttivi dell'apparecchio in modo che non garantiscono la sicurezza originaria (p. es. gli schemi di protezione devono essere fissati a regola d'arte).

I pezzi di ricambio devono corrispondere al pezzo da sostituire nei loro dati e nei loro connotati per garantire la stessa sicurezza dell'apparecchio. Usate perciò solo ricambi originali.

Important note

The unit must remain safe after repair or checking. Therefore, no design features of the unit may be altered which would result in a reduction of safety (e.g. covers must be properly replaced).

With regards to their data and technical features, spare parts must correspond with the replaced part, so as not to reduce the safety of the unit. Therefore, only use original spare parts.

Recommandations importantes

L'appareil doit remplir les mêmes conditions de sécurité après une réparation ou une révision. Aucune caractéristique de construction de l'appareil ne doit donc être modifiée de telle sorte que la sécurité de l'appareil en soit diminuée (par ex., les couvercles doivent être remis en place correctement).

Les caractéristiques et les propriétés des pièces de rechange doivent coïncider avec celles de la pièce qui est remplacée afin de ne pas réduire la sécurité de l'appareil. N'utilisez donc que des pièces de rechange d'origine.

Gedruckte Schaltung · Piastra stampate

Bauteileseite

Lato componenti

Printed Circuit · Circuit imprimé

Component side

Côté d'insertion

**HF/ZF-Platte
Piastra RF/FI
RF/IF-PCB.
Platine HF/FI**

**Ein/Aus Schalterplatte
Piastra interruttore
On/off switch PCB.
Platine inter M/A**

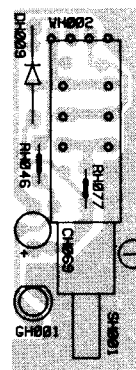

**Festsendereinstellung
Piastra di preselezione
Pretuning PCB.
Platine présélection**

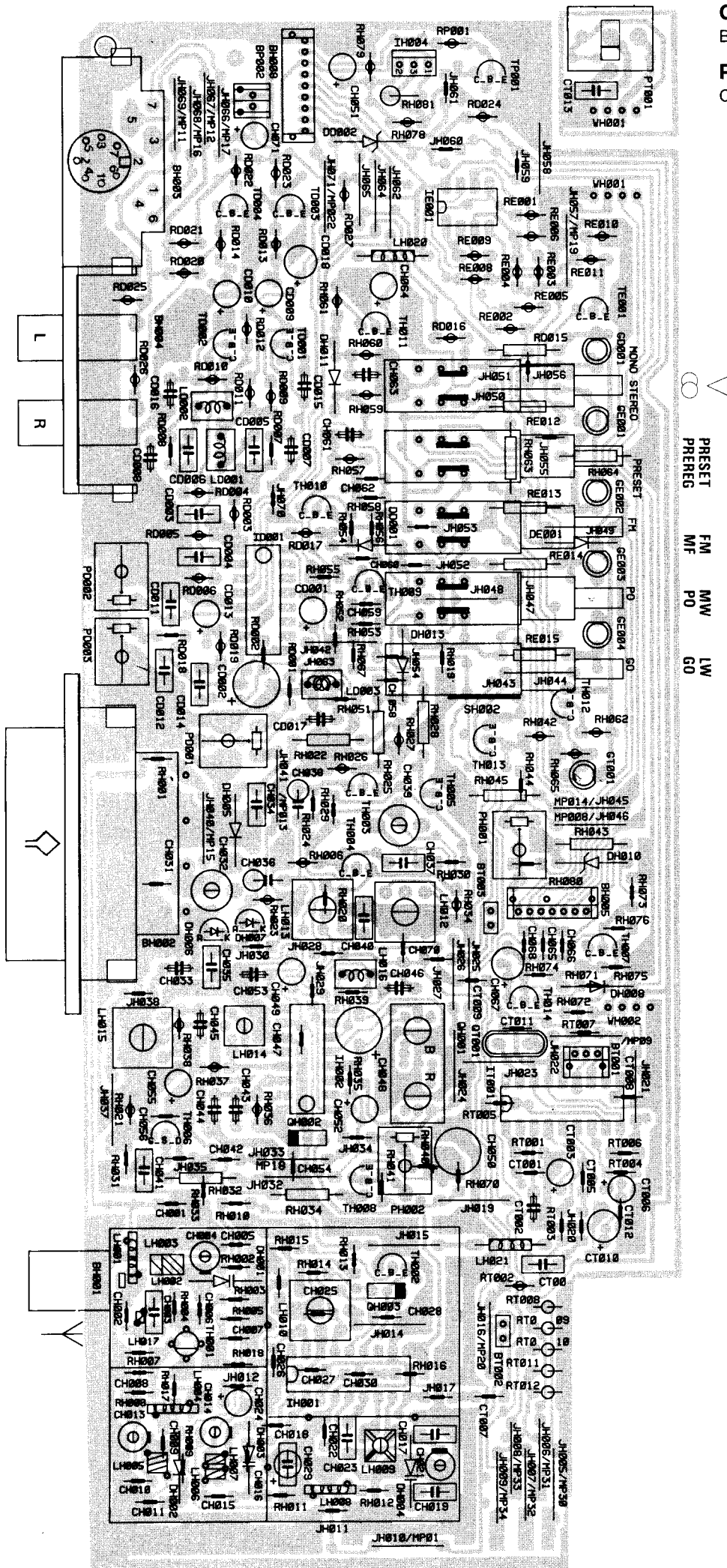
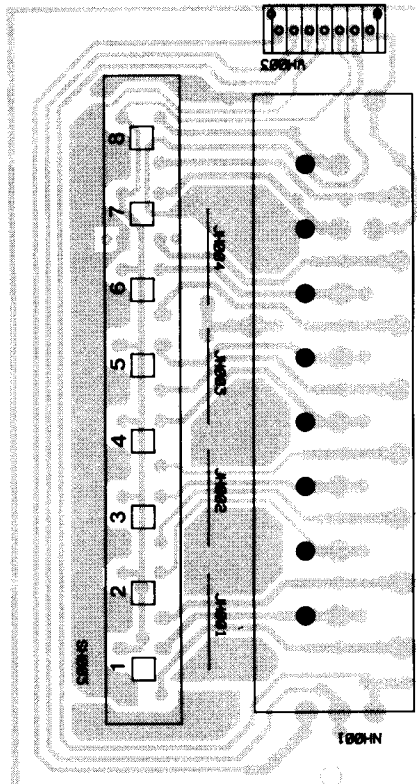

PRESET
PREREG
FM
MW
LW
GO

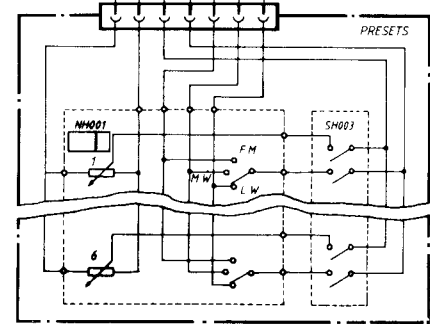
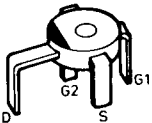
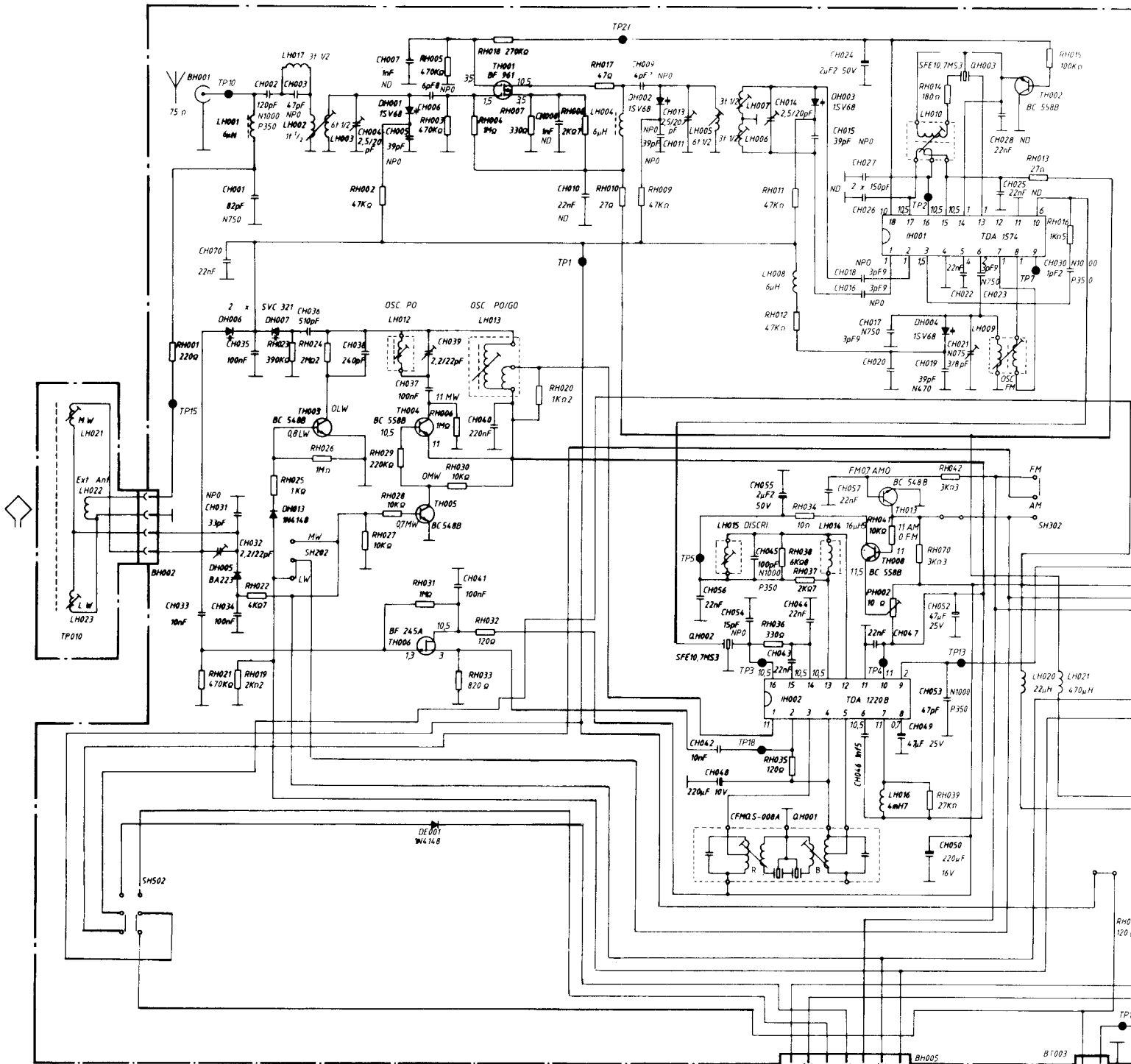

BF961

BC548B
BC550C
BC558B/C
BC560C

BF245A

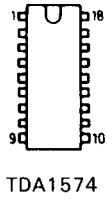
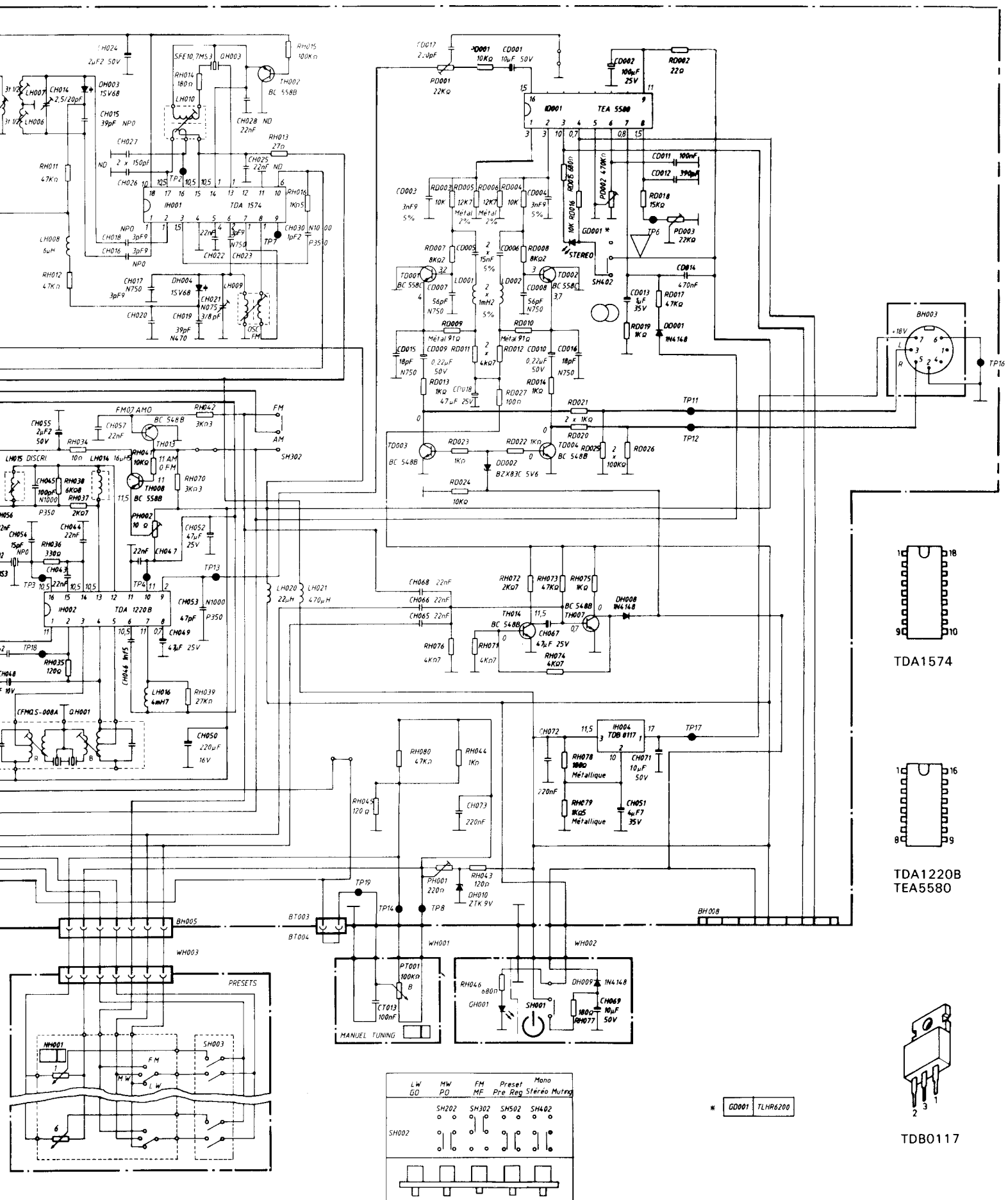

TDA1574

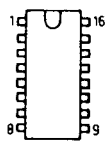

TDA1220B
TEA5580

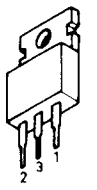

TDB0117

LW	MW	FM	Preset	Mono
GO	PQ	ME	Pre Reg	Stereo Muting
	SH202	SH302	SH502	SH402
SH002				

* GD001 TLH6200

Position	V
	Z
	D
	F
	G
	FI
	GO
	TP
	K
	S
	SI
	Co
	Cl
	S
	Z
	S
	P
	S
	D
	GR
	SH
	F
	NF
	SH
	Gr
	ID
	I
	I
	I
	T
	T
	OC
	TH
	TH
	DD
	01

FM					
			f		
	1			PH001	V = 1 V ± 10 mV
IF FI ZF	2		10,7 MHz	PH002 (Amp)	
	3			LH015 (sym)	
		$V_e \approx 100 \mu V$			
FM MF	4		87,5 MHz	LH009	TP11 Max.
	5		108,15 MHz	CH021	
	6		90 MHz	LH002/3, LH005/6/7/10	
	7		101 MHz	CH004/13/14	
		$V_e \approx 1,5 \mu V$			

Decoder					
			f		
	1	$V_e \approx 1 \text{ mV stéréo}$	98 MHz	98 MHz	TP6 → 228 kHz ± 2 kHz
	2		98 MHz	98 MHz	TP11 Diaphonie min.
	3		98 MHz	98 MHz	TP11 19 kHz min.

AM					
			f		
			30% mod 1000 Hz		
IF FI ZF	1	TP15 $V_e \approx 100 \mu V$	≈ 460 kHz	QH001R	TP11 Max.
				QH001B	
MW	2	TP15 $V_e \approx 100 \mu V$	510 kHz	LH012	TP11 Max.
	3		1630 kHz	CH039	
PO	4	TP15 $V_e \approx 10 \mu V$	600 kHz	LH021	
	5		1500 kHz	CH032	
LW	6	TP15 $V_e \approx 100 \mu V$	145 kHz	LH013	TP11 Max.
GO	7	TP15 $V_e \approx 10 \mu V$	150 kHz	LH023	

Seilzu
Functio
Cord
Cordo

Ersatzteilliste · Lista ricambi · List of spare parts · Liste de pièces détachées

SABA Ersatzteilliste		MT 110	HiFi 254	Seite 1
Position	Teil	Bemerkungen	Best-Nr.	Preisgruppe
	<u>Verpackung kpl.</u>		4900 056 521	AL
	<u>Zubehör</u>			
	DIN-Kabel 7 pol.		4900 056 758	BA
	Ferritantenne kpl.		4900 056 540	AZ
	<u>Gehäuse</u>			
	Frontplatte		4900 056 522	BA
	Anzeigefenster Stereo		4900 056 546	AH
	Skalenfenster		4900 056 548	AK
	Klappe Festsendereinstellung		4900 056 529	AM
	Gehäuseoberteil		4900 056 528	AL
	Taste			
	POWER		4900 056 523	AI
	STATIONS		4900 056 524	AB
	LW...MONO		4900 056 525	AC
	Knopf			
	TUNING FINE		4900 056 526	AD
	TUNING COARSE		4900 056 527	AF
	Skalenzeiger		4900 056 545	AH
	Gehäusefuß		4900 056 627	AB
	<u>Chassis</u>			
	Seilrolle		4900 056 541	AE
	Achse		4900 056 539	AB
	Zugfeder (Seil)		4900 056 542	AB
	<u>Senderwahl Platine</u>			
	PT 001 Poti 100 K Manuell Tuning		4900 056 535	AX
	<u>Schalter Platine</u>			
	DH 009 IN4148		3512 216 000	AA
	GH 001 LED rot TLHR6205		4900 056 613	AG
	SH 001 Schalter Ein-Aus		4900 056 543	AK
	<u>Festsender-Einstellplatine</u>			
	NH 001 Festsendereinstell-Block		4900 056 533	AY
	SH 003 Schaltersatz 6 x Festsender		4900 056 538	AW
	<u>Grund-Platine</u>			
	ID 001 TEA5580		4900 049 785	AS
	IH 001 TDA1574		4900 055 936	AT
	IH 002 TDA12208		4900 056 544	AO
	IH 004 LM317T		4900 049 786	AN
	TD 001,002 BC558C		3528 515 000	AC
	TD 003,004, TH 003,005, 007,013,014 BC548B		3528 509 000	AB
	TH 001 BF961		3528 540 032	AK
	TH 002,004,008 BC558B		3528 514 000	AE
	TH 006 BF245A		3528 196 000	AL
	DD 001, DE 001, DH 008, 013 IN4148		3512 216 000	AA

SABA Ersatzteilliste		MT 110	HiFi 254	Seite 2
Position	Teil	Bemerkungen	Best-Nr.	Preisgruppe
	DD 002 BZX83C5V6		3512 605 000	AD
	DH 001...004 1SV68		4900 028 805	AI
	DH 005 BA223		4900 046 371	AE
	DH 006, 007 SVC321C		4900 046 372	AL
	DH 10 (IC) ZTK9		4900 056 531	AH
	GD 001 LED rot TLHR 6200		4900 056 752	AF
	Stereo			
	LD 001, 002		4900 056 232	AE
	LD 003		4900 056 532	AA
	LH 001, 004, 008		4900 055 944	AD
	LH 002		4900 055 945	AC
	LH 003		4900 055 946	AC
	LH 005		4900 055 947	AC
	LH 006, 007		4900 055 948	AC
	LH 009		4900 055 949	AH
	LH 010		4900 055 950	AH
	LH 012		4900 055 954	AG
	LH 013		4900 056 238	AG
	LH 014		4900 056 239	AH
	LH 015		4900 056 240	AH
	LH 016		4900 055 937	AF
	LH 017		4900 055 956	AC
	LH 020		4900 056 234	AD
	LH 021		4900 056 235	AD
	QH 001 455 KHz		4900 055 963	AW
	QH 002, 003 Keramik Filter		4900 056 242	AH
	CH 004,013,014,021 Trimmer 2,5 - 20 pF		4900 055 941	AI
	CH 032,039 Trimmer 2-22 pF		4900 055 942	AG
	PD 001,003 Poti 22 K		4900 056 240	AD
	PD 002 Poti 470 K		4900 055 959	AD
	PH 001 Poti 220 Ohm		4900 056 534	AD
	PH 002 Poti 10 Ohm		4900 056 241	AF
	SH 002 (202...502)		4900 056 537	AX
	Schaltersatz LW...Mono			
	BH 002 Buchse Ferritantenne		4900 055 939	AO
	BH 003 Buchse DIN 7 pol.		4900 056 236	AI

Seilzug
 Funzionamente fune
 Cord drive
 Cordonnet d'entraînement

