

Schaltschema für SABA-Meersburg-Automatic 8

Konstruktionsänderung vorbehalten!

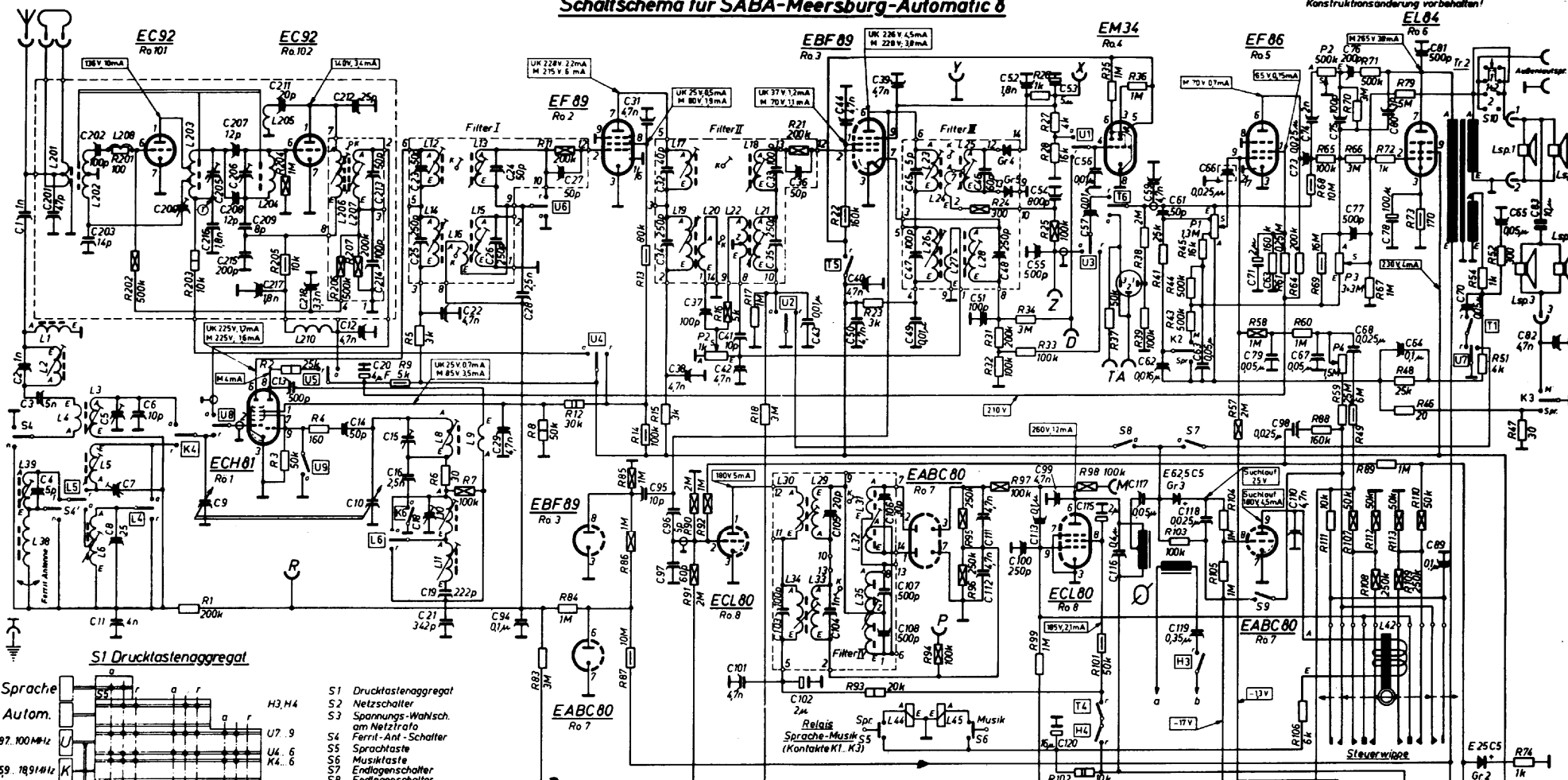

S1 Drucktastenaggregat

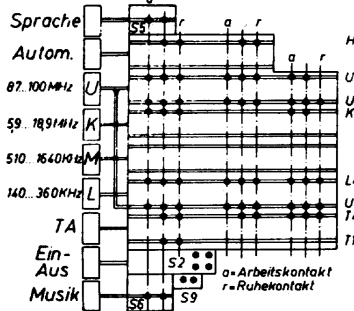

- S1 Drucktastenaggregat
- S2 Netzschalter
- S3 Spannungswahlsch. am Netztrfo
- S4 Ferrit-Ant-Schalter
- S5 Sprachtaste
- S6 Musiktaste
- S7 Endlagenschalter
- S8 Endlagenschalter
- S9 Stummenschalter
- S10 Lautsprecher-Umschalter

Ferritantennen-Schalter S4

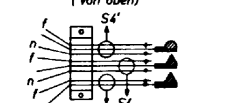

Belast.d.Widerst.

- 1/10 W
- 1/4 W
- 1/2 W
- 1 W
- 2 W
- 4 W

Röhren-Anschlüsse

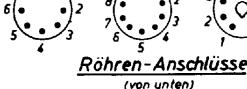

Meßbuchsen

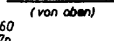

Lautspr.-Buchse

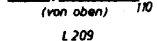

Filter-Anschlüsse

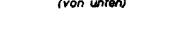

Gleichspannungsmessung mit Drehspul-Instrument Ri > 20kOhm/Volt
(z.B. Mikro-Multizet oder Röhrenvoltmeter)

Sicherungen:
S1 1Q5A bei 105V u 220V
S2 1Q8A bei 110V, 130V u 155V

57050-3000

SABA ITALIA - Modd. Meersburg e Breisgau. Apparecchi a modulazione d'ampiezza e di frequenza, ad onde lunghe, medie, corte e ultracorte. Sono provvisti di dispositivo elettronico a quattro valvole per la ricerca automatica delle emittenti. Sono ambedue del tipo ad alta fedeltà musicale. Medie frequenze a 460 kc/s e a 10,7 Mc/s. Potenza indistorta d'uscita 3 watt. Consumo 50 watt.