

SABA Service-Instruction

T 233
T 234

SOFT OPERATING STEREO CASSETTE DECK CD 110
SOFT OPERATING STEREO CASSETTE DECK CD 11

CD 110
CD 11

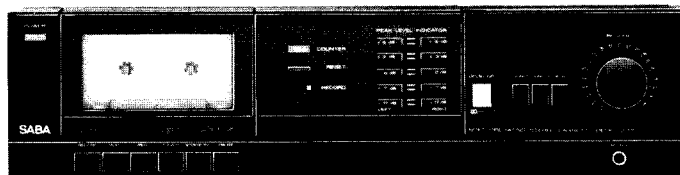

CD 110

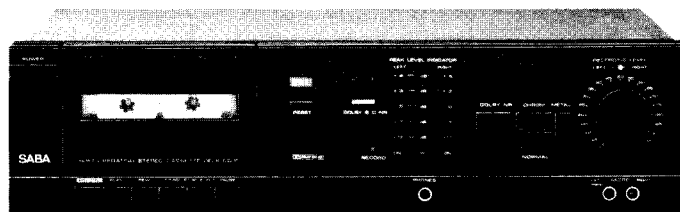

CD 11

Wichtige Hinweise

Die Sicherheit des Gerätes muß nach einer Reparatur oder Überprüfung erhalten bleiben. Es dürfen deshalb keine konstruktiven Merkmale des Gerätes sicherheitsmindernd verändert werden (z. B. müssen Abdeckungen ordnungsgemäß angebracht sein).

Ersatzteile müssen hinsichtlich ihrer Daten und ihrer Merkmale dem getauschten Teil entsprechen, damit die Sicherheit des Gerätes nicht vermindert wird. Verwenden Sie deshalb nur Original-Ersatzteile.

Important note

The unit must remain safe after repair or checking. Therefore, no design features of the unit may be altered which would result in a reduction of safety (e. g. covers must be properly replaced).

With regards to their data and technical features, spare parts must correspond with the replaced part, so as not to reduce the safety of the unit. Therefore, only use original spare parts.

Avvisi importanti











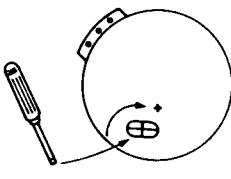
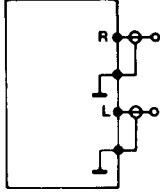
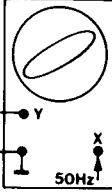

La sicurezza dell'apparecchio deve rimanere conservata anche dopo una riparazione o un controllo. Perciò non è permesso di variare connotati costruttivi dell'apparecchio in modo che non garantiscono la sicurezza originaria (p. es. gli schemi di protezione devono essere fissati a regola d'arte).

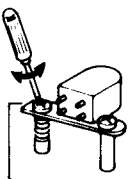
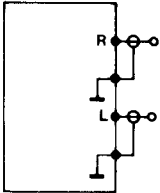
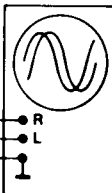
I pezzi di ricambio devono corrispondere al pezzo da sostituire nei loro dati e nei loro connotati per garantire la stessa sicurezza dell'apparecchio. Usate perciò solo ricambi originali.

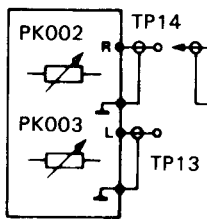
Recommandations importantes

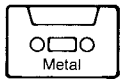
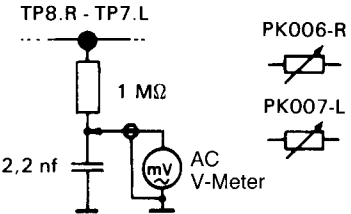
L'appareil doit remplir les mêmes conditions de sécurité après une réparation ou une révision. Aucune caractéristique de construction de l'appareil ne doit donc être modifiée de telle sorte que la sécurité de l'appareil en soit diminuée (par ex., les couvercles doivent être remis en place correctement).

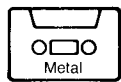
Les caractéristiques et les propriétés des pièces de rechange doivent coïncider avec celles de la pièce qui est remplacée afin de ne pas réduire la sécurité de l'appareil. N'utilisez donc que des pièces de rechange d'origine.

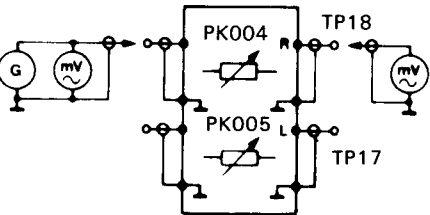
<p>1</p> <p>Bandzug Tensione del nastro Tape tension Tension de bande</p>			<p>«→»</p> <p>40 g/cm <math>\mathcal{M}</math> <math>< 70</math> g/cm</p> <p>«←>»</p> <p>80 g/cm <math>\mathcal{M}</math> <math>< 160</math> g/cm</p>
<p>2</p> <p>Bandgeschwindigkeit Velocità del nastro Tape speed Vitesse de défilement</p>	  <p>f = 50 Hz</p>	 	 <p>50Hz</p>
<p>3</p> <p>Tonkopfeinstellung Regolazione di azimut Azimuth adjustment Réglage d'azimut</p>	  <p>f = 10 kHz (6,3 kHz)</p>	 	<p>PR = PL</p> 
<p>4</p> <p>Wiedergabeempfindlichkeit Sensibilità di riproduzione Playback sensitivity Gain en lecture</p>	  <p>400 Hz</p>		<p>Vs = 530 mV 0 dB ± 0,5</p>
<p>5</p> <p>Vormagnetisierung Corrente di premagnetizzazione Bias adjustment Courant de prémagnétisation</p>	 	<p>TP8.R - TP7.L</p> 	<p>V = 32 mV ± 0,5 dB</p>
<p>6</p> <p>Aufnahmeempfindlichkeit Sensibilità registrazione Record sensitivity Gain en enregistrement</p>	   <p>Ve = 50 mV ± 1 dB f = 400 Hz</p>		<p>V = 110 mV ± 0,5 dB</p>

SABA				
CD 11		T 234		3
Pos.	No.	Bezeichnung	Description	
		<u>Grund Platine</u>	<u>Main Board</u>	
3531	171 000	A1	TK 001	RC4558P
3531	227 000	AK	IK 002	MC/R12CT oder SFC2812EC
4900	040 462	AF	TK 003,004	BC651C
352R	509 000	AB	TK 071,010	BC349C
352R	501 000	AB	TK 011,012	BC338-40
352R	461 000	AH	TK 013	BD135
352R	515 000	AC	TK 014,015	BC558C
4900	056 407	AH	LJ 001,002	23 mH
4900	056 117	AG	LJ 003,004	36mH
4900	056 124	AM	LK 001,002	Filter
4900	056 126	AH	LK 003	Filter
4900	056 124	AG	LK 004,005	6,8mH
4900	056 430	AC	BK 064	20 Ohm/5%/1W

4900 056 960	AD	PK002...005	Pot1 22 K	
4900 056 129	AD	PK 006,007	Pot1 100 K	
4900 056 410	AW	SK 002	Tastensatz Dolby, NH, Normal, Chrom Metal	SK 002 Switch Dolby, NH, Norm, Chr., Metal
4900 056 131	AM	SK 003	Schalter Ein-Aus	SK 003 Switch Power
4900 056 411	AL	SK 004	Schalter Aufn./ Wdg.	SK 004 Switch Rec. Play
4900 056 236	AI	BK 004	Buchse DIN 7 pol.	BK 004 DIN Jack 7 pin
<u>Dolby Platine</u>				
4900 056 116	BE	LJ 050	TEA0665	
4900 056 117	AG	LJ 050	36 mH 5%	
4900 01R 366				
<p>A = Austauschteil R = Reparatur-Umtauschteil (kein Voraussatz möglich)</p> <p>⚠ Sicherheitsbauteil ⚠ Componente di sicurezza ⚠ Safety part</p> <p>Benutzen Sie Originalteile In caso di sostituzione usare componenti originali When repairing, use original parts only</p> <p>Änderungen vorbehalten! Con riserva di modifiche! Subject to modification without notice! Modifications réservées!</p>				

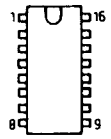

TA7629P

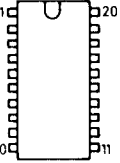

U2068

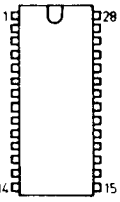

TEAO665

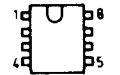

LM393
RC4558P
U267B



TLHG200
TLHR6200

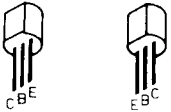

BC338 BC651C
BC548C BC558C BC550C

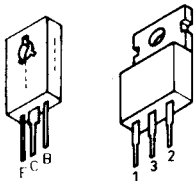

BD135 MC7812CT
SFC2812EC

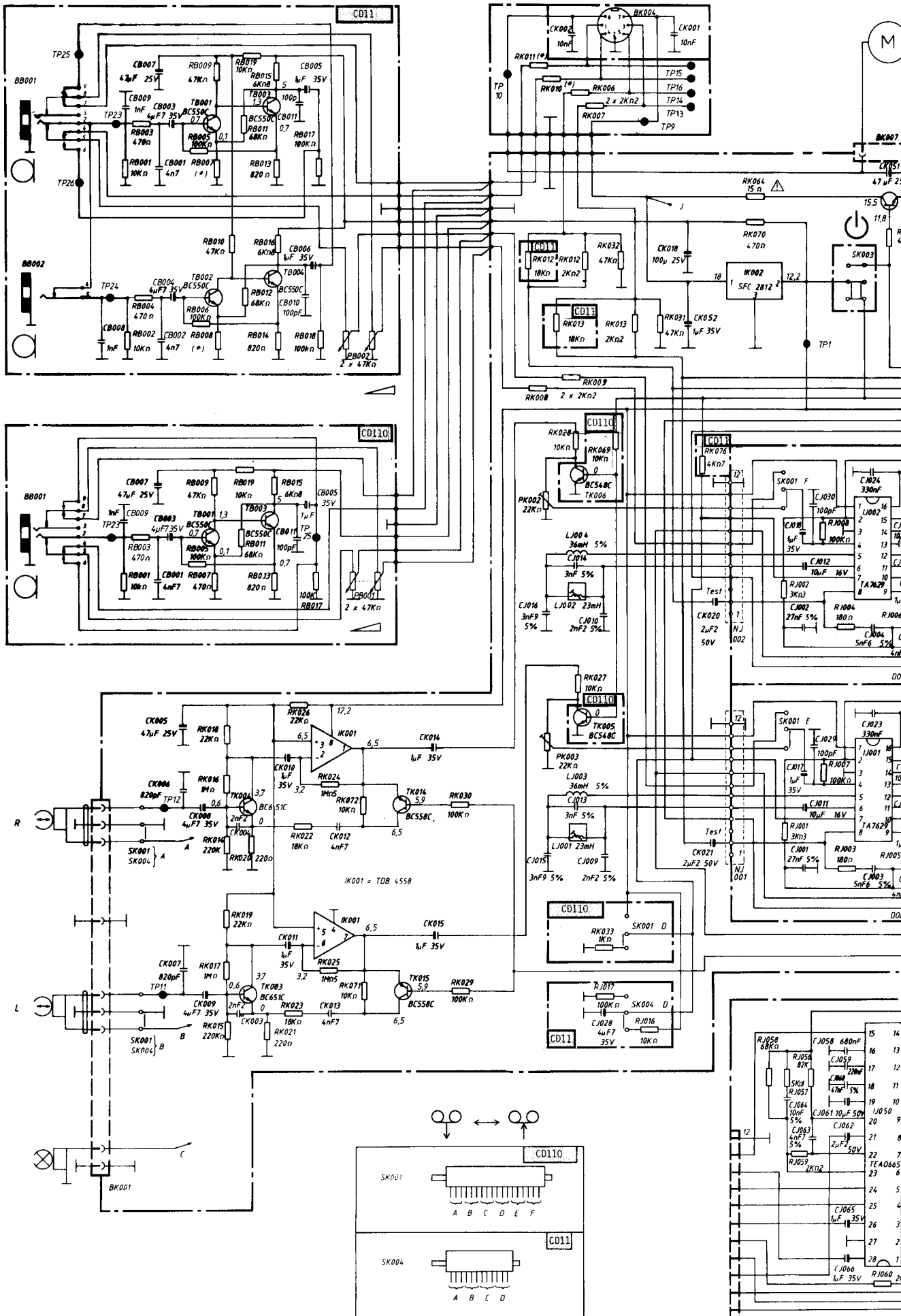

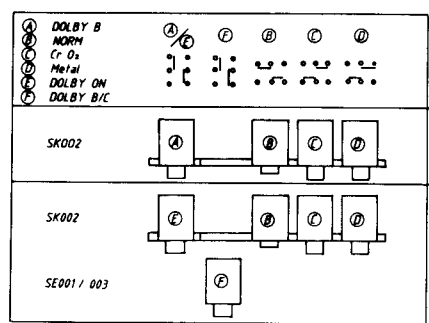
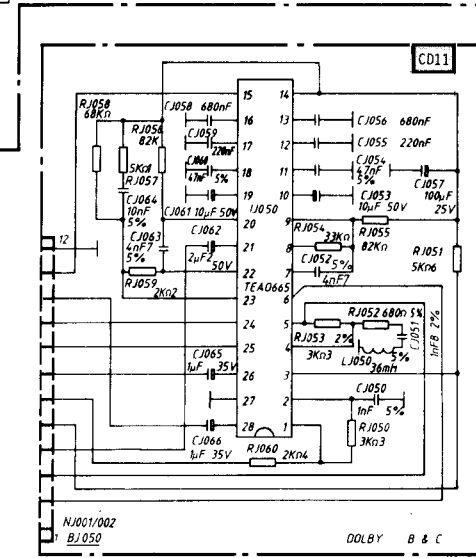
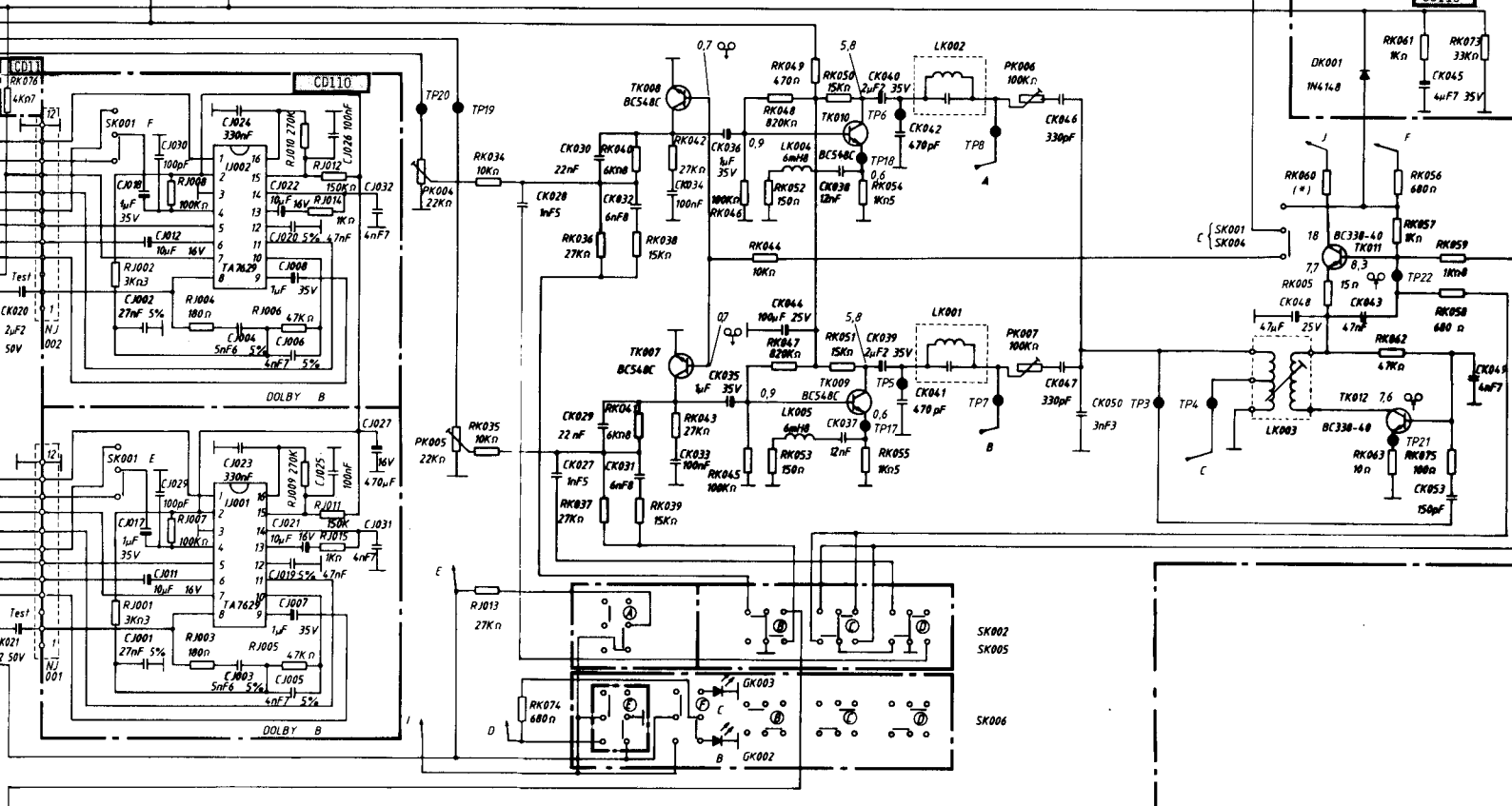
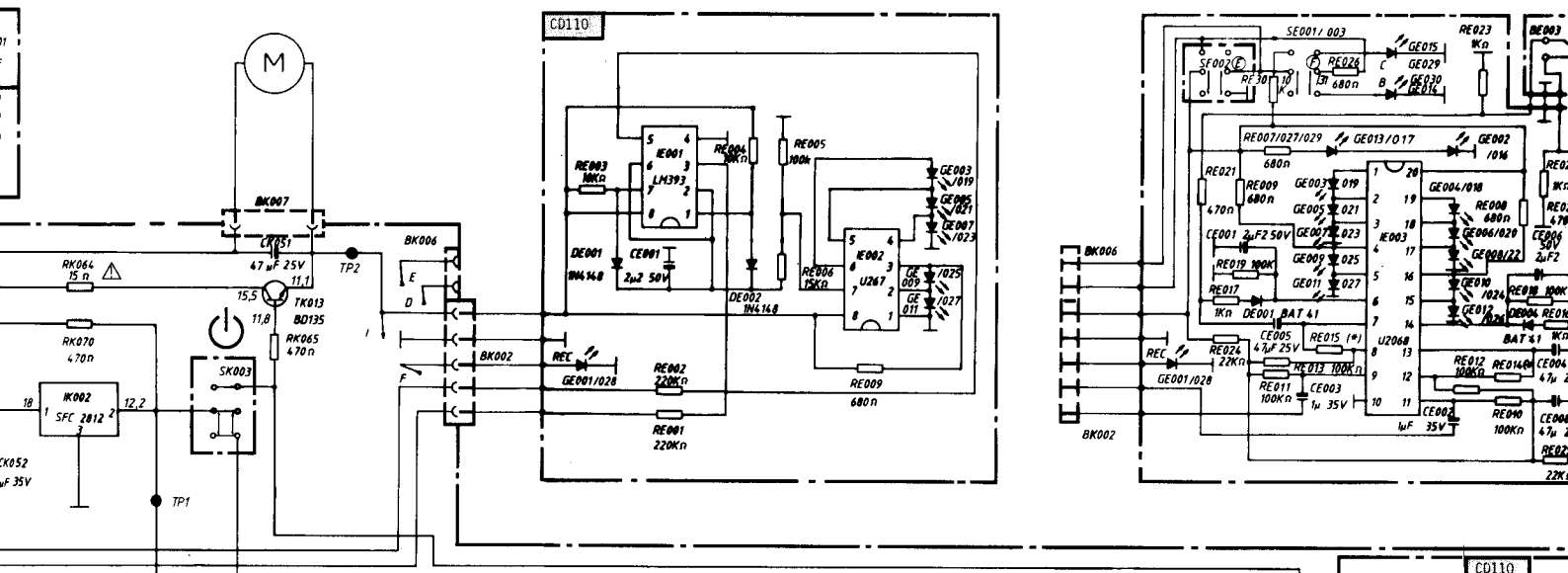

	AK 010/011	RE 014/015	RB 007/008
CD110	47K n		
CD111	22K n	56K n	330 n

Bauteil oder Platine bestückt je nach Ausführung.
 Componenti o piastre montati secondo versioni degli apparecchi.
 Components or Pcb's inserted according to the versions.
 Composants ou platines câblés selon versions d'appareils.

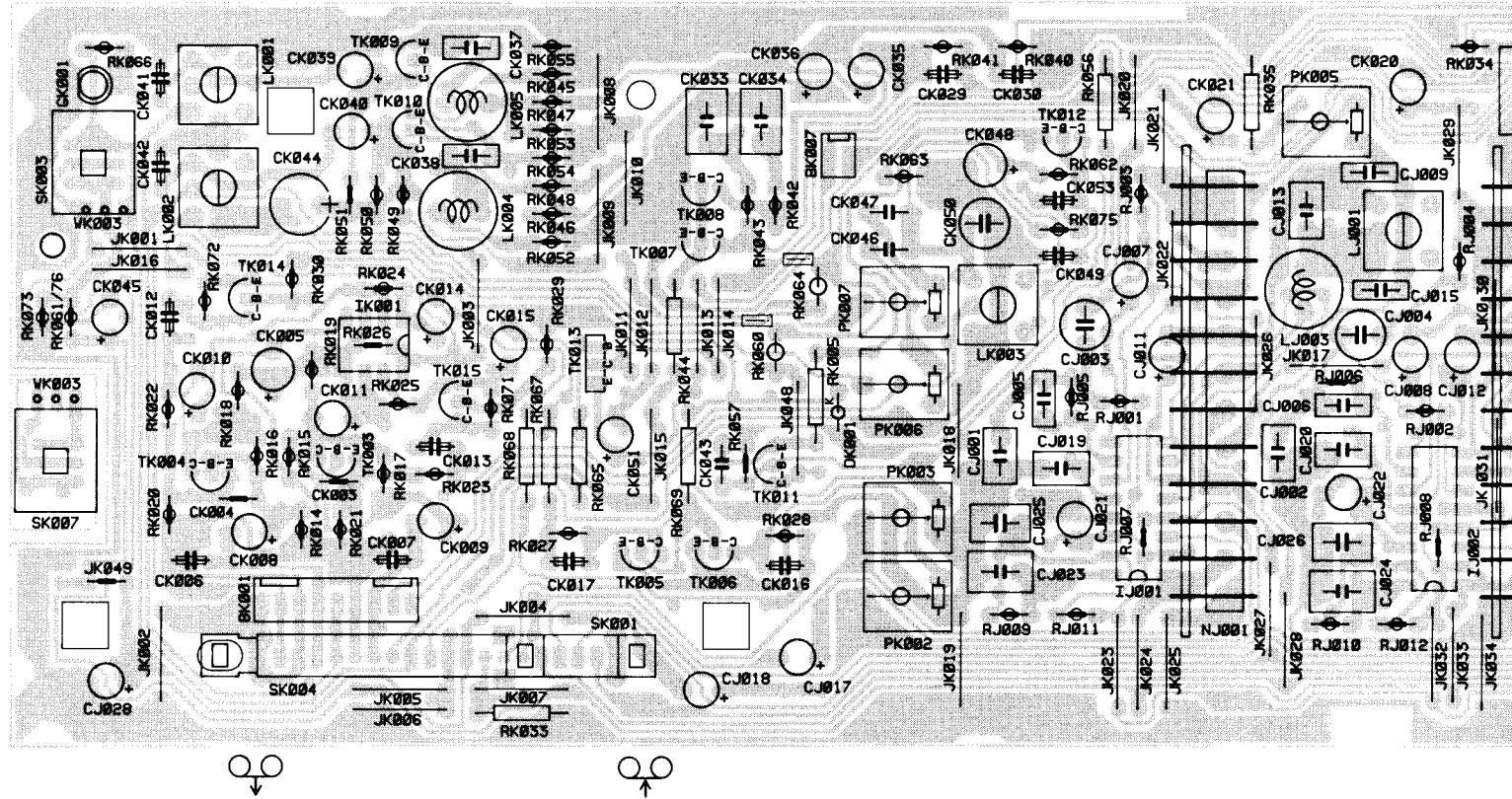

Buchse/BK 004 · Presa/BK 004 · Jack/BK 004 · Prise/BK 004

Anzeigeplatte
Piastra indicatore
P.C.B. indicators
Platine voyants

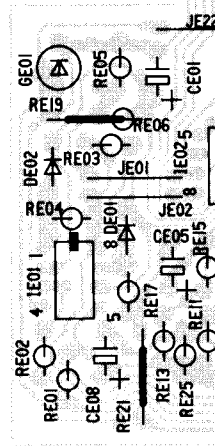
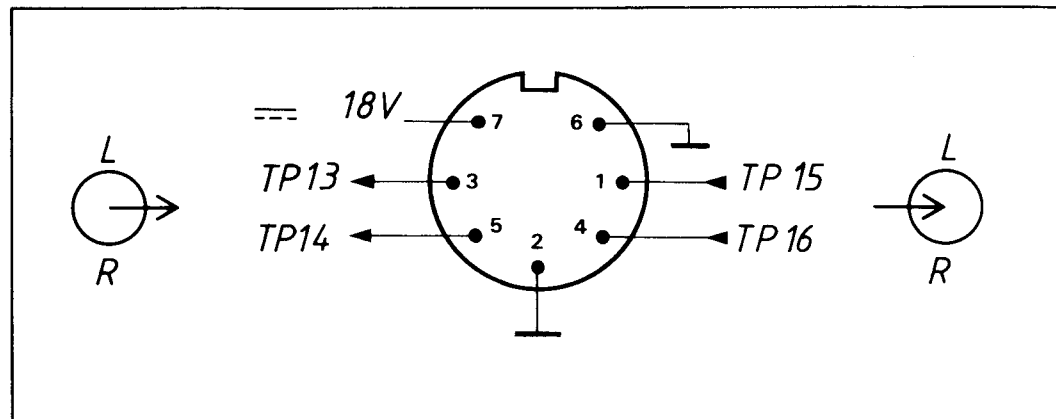

IJ50 c

Mikrofonbuch
Piastra prese
P.C.B. micro-
Platine prises

IJ001					
IJ002					
1	12,2	12,2	9	0	0
2	6,1	6,1	10	0	0
3	0	0	11	0	0
4	5,2	5,2	12	6,1	6,1
5	6	6	13	0	0
6	6,1	6,1	14	6,2	6,2
7	12,2	12,2	15	6,3	5,8
8	6,1	6,1	16	9,1	5,4

1	5,7	11	5,9	21	6
2	5,7	12	0,8	22	6
3	5,7	13	0,8	23	6
4	5,7	14	5,9	24	0,4
5	0	15	12,2	25	9,7
6	0	16	0,8	26	5,8
7	5,7	17	0,8	27	0
8	5,8	18	5,8	28	4,2
9	5,8	19	5,8		
10	5,9	20	5,8		

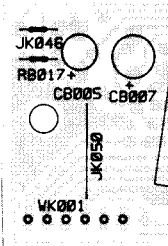

Platine bestückt je nach Ausführung CD 110/CD 11
 Piastra montati secondo le versioni degli apparecchi CD 110/CD 11
 PCB's inserted according to the versions CD 110/CD 11
 Platines câblés selon les versions d'appareils CD 110/CD 11

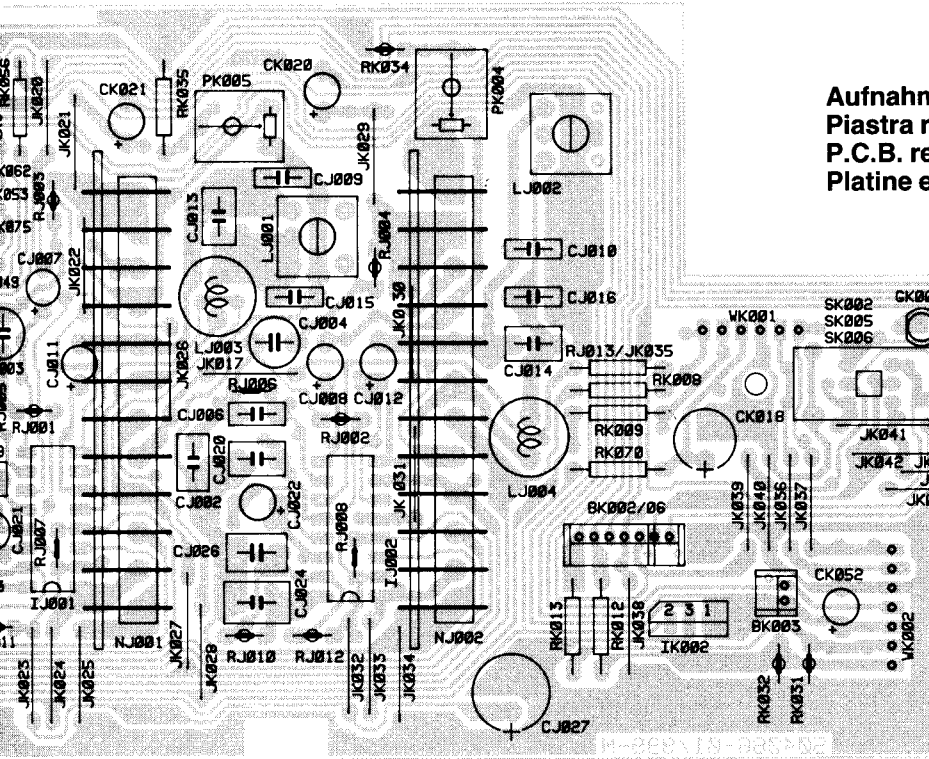

Aufnahme/Wiedergabe-Entzerrerplatte
 Piastra registrazione/riproduzione
 P.C.B. record/playback
 Platine enregistrement/lecture

Anzeigeplatte
 Piastra indicatore
 P.C.B. indicators
 Platine voyants

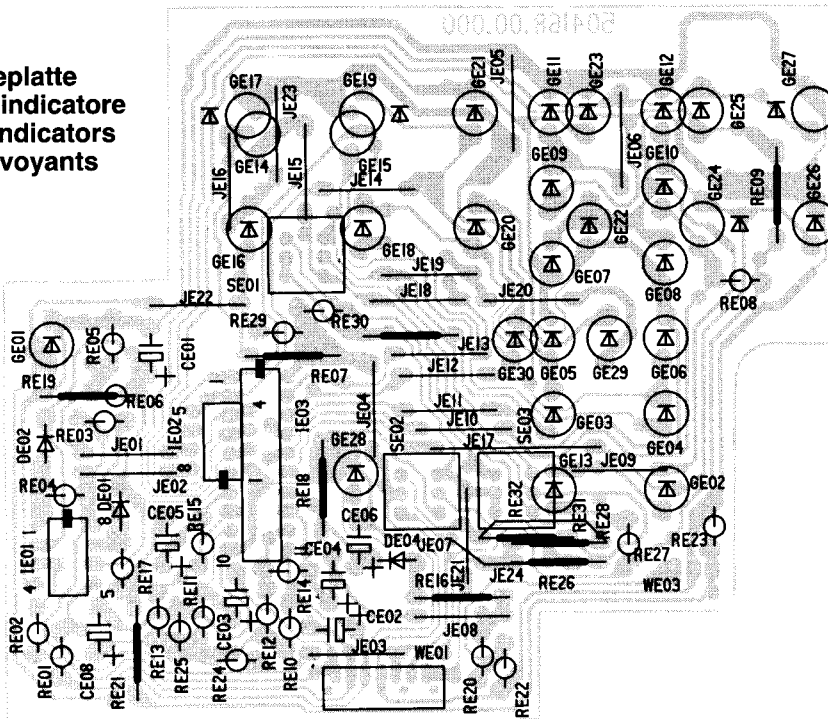

Dolby-Platte
 Piastra Dolby
 P.C.B. Dolby
 Platine Dolby

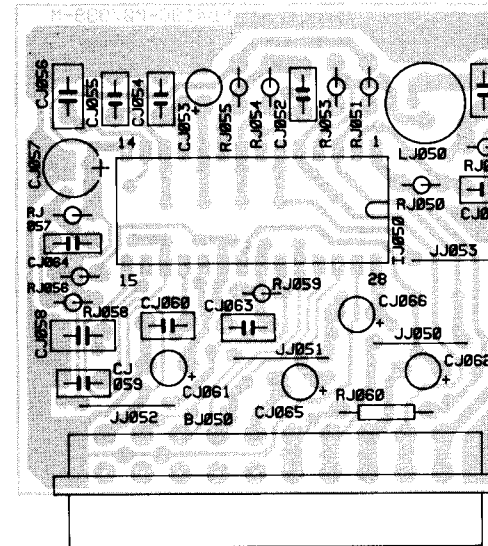

Mikrofonbuchsen/Aussteuerungsregler-Platte
 Piastra prese microfoni/comandi del livello di registrazione
 P.C.B. micro-jack/level control
 Platine prises micro/pot. niveau d'enregistrement

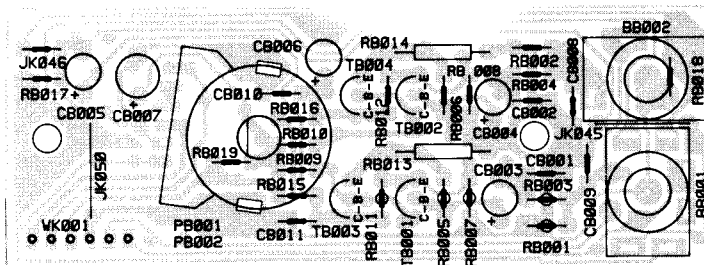

Buchsenplatte · Piastra presa
 P.C.B. socket · Platine prise

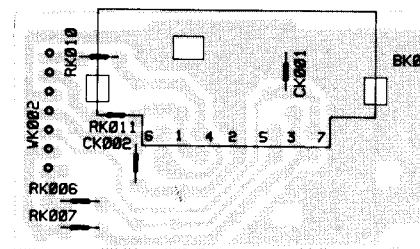

Laufwerk CD 110 · Meccanismo di scorrimento CD 110 · Mech.-Ass'y CD 110 · Systemé d'entraînement CD 110

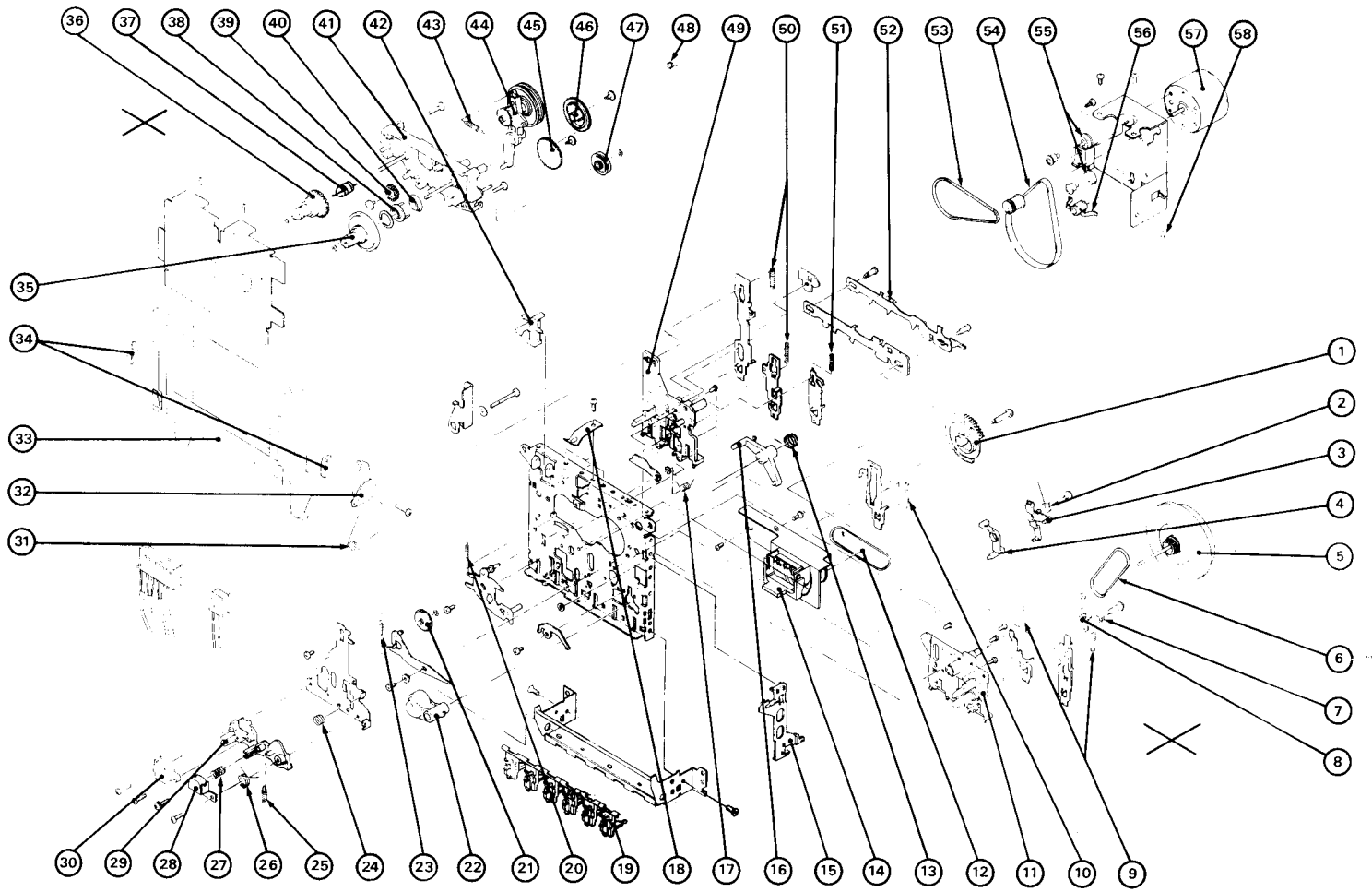

Laufwerk CD 11 · Meccanismo di scorrimento CD 11 · Mech.-Ass'y CD 11 · Systemé d'entraînement CD 11

