

OPERATING INSTRUCTIONS & SERVICE MANUAL

SOLID-STATE AM/FM STEREO TUNER AMPLIFIER

SANSUI 200

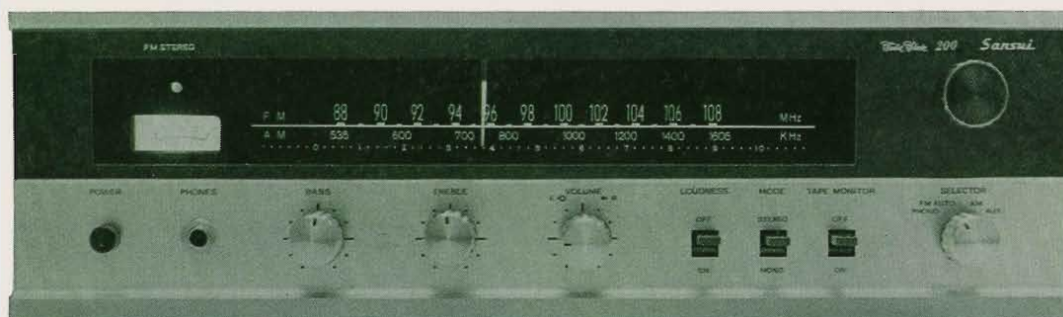

Sansui

SANSUI ELECTRIC COMPANY LIMITED

In selecting the Sansui 200 AM/FM Multiplex Stereo Tuner Amplifier, you have made a wise choice, one that will offer you years of quality stereo enjoyment.

Like all Sansui products, the 200 combines the finest in internal engineering, performance and design. It has been precision built, tested and re-tested to perform flawlessly within the limits of its specifications.

This manual has been prepared to help you keep the 200 in perfect operating conditions. It explains all of the 200's unique features, installation and playing procedures, as well as some basic maintenance requirements.

Please read the contents of this manual carefully before operating the receiver. You will then be better prepared to hear the 200 perform up to its capabilities.

CONTENTS

SWITCHES AND CONTROLS	3, 4
OPERATION	5, 6
—SPEAKER CONNECTION	
—RECORD PLAYING	
OPERATION	7, 8
—ANTENNA CONNECTION	
—RADIO RECEPTION	
OPERATION	9, 10
—TAPE PLAYBACK	
—TAPE RECORDING	
MAINTENANCE.....	11, 12, 13
SPECIFICATIONS	14
SCHEMATIC DIAGRAM	15, 16
TROUBLESHOOTING CHART	17, 18
DISASSEMBLE PROCEDURE/DIAL MECHANISM	19
ALIGNMENT	
—TEST POINTS.....	20
—FM TUNER ALIGNMENT PROCEDURE.....	21
—FM MULTIPLEX ALIGNMENT PROCEDURE	22
—AM TUNER ALIGNMENT PROCEDURE	23
PRINTED CIRCUIT SHEETS AND PARTS LIST	
.....	24, 25, 26, 27, 28
OTHER PARTS AND THEIR POSITION ON CHASSIS	
.....	29, 30

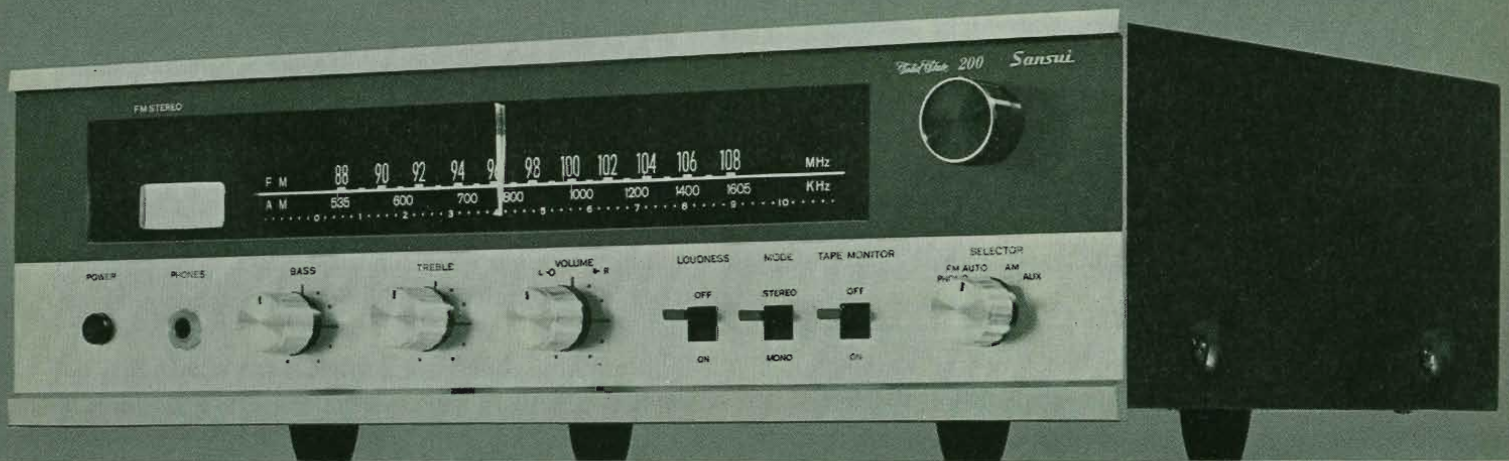

SWITCHES AND CONTROLS

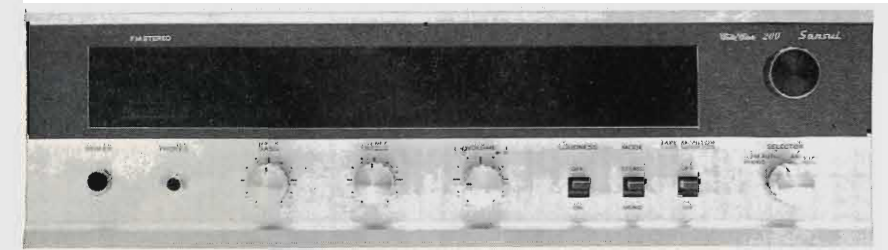

FM Stereo Indicator

This indicator automatically lights up when a stereo program is received. During mono reception, it remains unlit.

Tuning Meter

This meter aids in pinpointing a station. The station, on either FM or AM band, is correctly tuned when the pointer has swung as far to the right as it will go.

Power Switch

Push to turn the power on; push again to turn the power off.

Headphones Jack

To monitor a tape or to enjoy late-night listening through a headset without disturbing others, plug into this jack. Your speakers are turned off when the headphones are plugged into. This jack will accept any standard phono plug, but dynamic stereo headphones (Sansui SS-2) are recommended for use.

Bass Control

This control is used to boost or cut low-end response according to personal taste, speaker response and listening conditions. With the control in the mid-position the bass tones will sound exactly as recorded or broadcast. To emphasize the bass, turn it clockwise. To decrease the intensity of the bass tones, turn it counterclockwise.

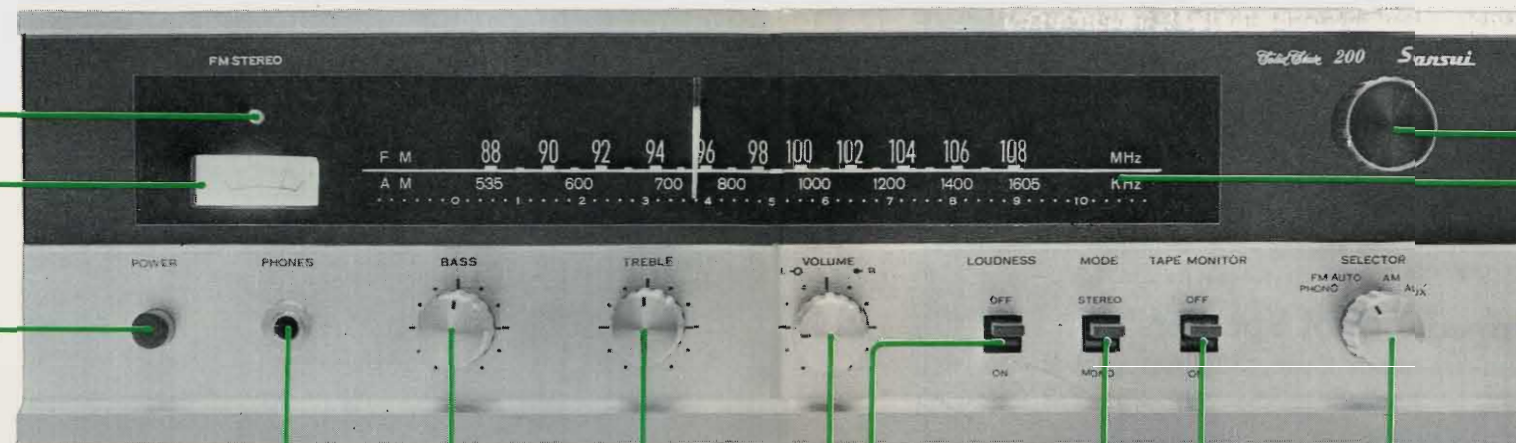

Treble Control

Use in the same manner as the BASS control to boost or reduce high-end frequency response.

Volume Control

This control consists of two concentric knobs. The outer black ring affects the right channel, and the inner silver knob, the left. The pair can be used simultaneously or independently, as required.

Normally, the entire control rotates as one unit. If you wish to increase the overall sound level of both channels, simply turn the VOLUME control clockwise.

If you want to balance the sound levels in the right and left channels in stereo mode, hold one of the knobs in place while adjusting the other.

Mode Switch

STEREO: The MODE switch in the STEREO position connects the left input to the left speaker and the right input to the right speaker. To listen to an FM multiplex stereo program, stereo record or stereo tape, set this switch to STEREO. **MONO:** The MODE switch in the MONO position connects either right or left, or both inputs, to the speakers of both channels.

Loudness Switch

This switch provides the correct amount of bass and treble boost required to compensate for an apparent loss of bass and treble at low listening levels.

Tuning Knob

Turn this knob to select the desired FM or AM stations.

Dial Scales

The upper scale indicates FM and the lower AM. To select a desired station, turn the Tuning knob at the right of the dial.

Selector Switch

Select the desired program source with this switch.

PHONO—Turn to this position to hear records being played on a phonograph connected to the PHONO input jacks on the rear.

FM AUTO—To hear FM broadcasts. In this position, the switch automatically selects the correct mode.

AM—To hear AM broadcasts.

AUX—To hear a component connected to the AUX inputs on the rear.

Tape Monitor Switch

This switch enables you to compare a recorded tape with the original program. When it is turned on, the tape being recorded is heard from the speakers. Monitoring is possible with 3-head tape recorders only. When you play back through the amplifier, it should be in the ON position as well. In all other cases, make sure it is in the OFF position.

OPERATION

— SPEAKER CONNECTION — RECORD PLAYING

LOUDSPEAKERS

Connection

Connect a pair of speakers to the SPEAKERS terminals on the rear of the 200 in this manner:

1. Connect the speaker on your right (as viewed from the listening area) to the red terminal marked (+) RIGHT.
2. Connect the lead from the common terminal of the right channel speaker (marked — or C) to the black terminal marked (–) RIGHT.
3. Connect the left channel speaker to the red terminal marked (+) LEFT.
4. Connect the lead from the common terminal of the left channel speaker to the black terminal marked (–) LEFT.

To connect to the terminals of the 200:

1. Depress the colored terminal button.
2. Push the stripped end of the lead wire in the hole as illustrated.
3. Release the button.

After connecting, make sure the wires are not shorted between the terminals. If shorted, the quick-acting fuse blows out and the amplifier becomes off.

If Speaker Polarities Are Not Matched...

You have connected the speakers. You are anxious to hear dynamic stereo sound; you turn the receiver on, set it in the desired mode and wait. What you hear disappoints you, however. It is as if sound is missing at both ends and in the center; you don't sense the continuity between the right and left speakers. The strong feeling of direction unique to true stereo sound is lacking. The heaviness of bass sound may be absent, too. In a word, sound is not natural.

If you experience such a phenomenon, it is because the polarities (+ and –) of the speakers are not matched with those of the receiver. The disappointing phenomenon described above is particularly conspicuous when the receiver is operating in the monophonic mode. If you suspect you have such

trouble when hearing an FM monophonic broadcast, for example, examine the speaker connections once. The unmatched polarities can be matched very simply by reversing the (+) and (–) connections of either speaker. Once they are matched, two speakers reproducing a monophonic material will sound as if there were only one speaker in the center.

Impedance of Speakers

Speakers of any make with impedance of 4 to 16 Ω may be hooked to the 200, with the following reservations:

1. Do not connect a pair of 4 Ω speakers in parallel to either right or left channel.
2. Do not connect more than one speaker of any impedance to either channel.
3. Do not connect speakers with other than specified impedance.

Failure to observe any of the above cautions may cause the quick-acting fuses to blow or distort the sound.

RECORD PLAYER

Connecting a Record Player

A record player or turntable using a 2 ~ 10mV magnetic cartridge with a built-in transformer is recommended for use with the 200.

1. Connect the left channel output of the player to the LEFT PHONO input on the rear of the amplifier.
2. Connect the right channel output of the player to the RIGHT PHONO input.
3. If a monophonic player or turntable is used, it may be connected to either LEFT or RIGHT PHONO jack.

NOTE: Although it is not recommended from a standpoint of tone quality, if a player with a crystal cartridge must be used, connect the output(s) of the player to the AUX jack(s) on the rear of the amplifier.

Playing a Record

1. Set the SELECTOR to PHONO.
2. Set the MODE switch to MONO if a monophonic phonograph is to be used, or to STEREO if a stereo phonograph is to be used.
3. Make appropriate settings of controls and switches on the phonograph.
4. Balance the sound levels in the right and left channels with the VOLUME control.
5. Use other controls and switches so suit taste and room acoustics.

NOTE:

- 1) If a monophonic record is to be played on a stereo phonograph, operate the receiver exactly in the same way for a stereo record for better results.
- 2) The balance of the sound levels in the right and left channels is most easily adjusted by playing a monophonic record through the receiver in the same way as a stereo record. Adjust it so that the two speakers will sound as if there were only one speaker in the center. To actually adjust, hold one of the VOLUME knobs in place while adjusting the other until the sound is correctly centered.

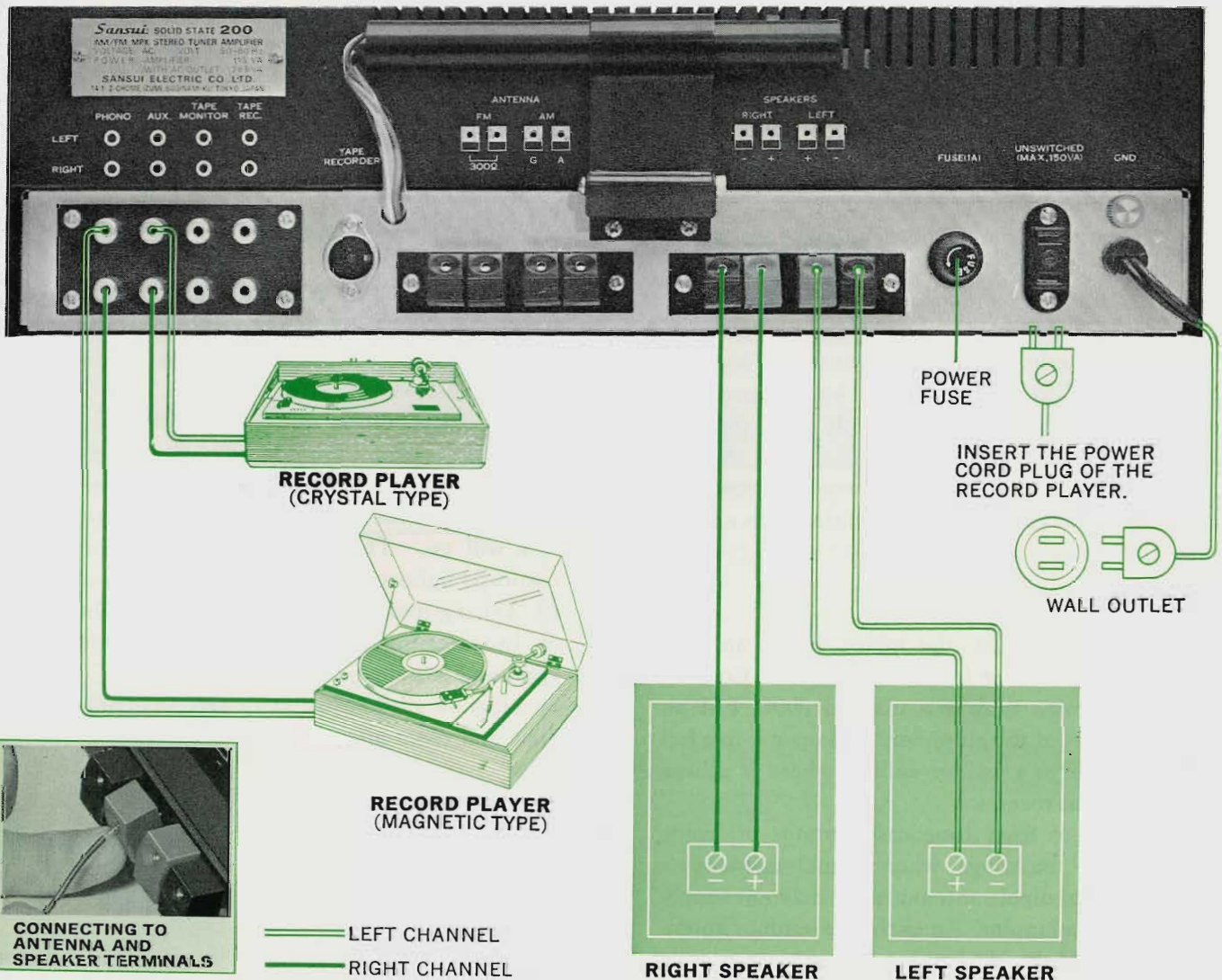

OPERATION

— ANTENNA CONNECTION — RADIO RECEPTION

ANTENNA CONNECTIONS

The efficiency of antennas greatly affects the quality of radio reception. To enjoy noise-free reception, use antennas as described below.

Built-in AM Ferrite Bar Antenna

A highly sensitive ferrite bar antenna is attached on the rear panel of the 200 to receive AM broadcasts. To use, pull it down and away from the receiver as shown on page 8. Except in weak signal areas remote from broadcast stations or inside ferroconcrete buildings, it should provide quality reception of those broadcasts.

Outdoor AM Antenna

In weak signal areas distant from broadcast stations or inside ferroconcrete buildings, the built-in ferrite bar antenna alone may fail to provide good reception of AM broadcasts. If this is the case, connect the PVC wire accompanying the receiver to the antenna terminal marked AM-A on the rear panel. Then run this wire outdoors and set it up as an antenna a little distance away from the buildings. For better results, ground the antenna terminal marked AM-G at the same time. As the sensitivity of an outdoor antenna varies greatly with its position, install it in the position which affords the best reception while actually listening to a broadcast. For reasons of safety, it should be outfitted with a lightning arrester.

FM Antennas

In strong signal areas, the folded dipole antenna (supplied) is adequate for FM reception. Connect it to the antenna terminals marked 300Ω FM on the rear panel of the amplifier, then open it to a full "T", and tack to a wall or ceiling where it allows the best signal reception.

In area remote from broadcast stations or inside ferroconcrete buildings where signal intensity is low, the folded dipole antenna alone may not supply sufficient signal inputs. An exclusive outdoor antenna for the FM band then becomes necessary just

as for. Two types of outdoor FM antennas, 300Ω balanced and 75Ω unbalanced, are commercially available. The usual choice is the 300Ω balanced type. On the receiver side, the feeder wire of this antenna is connected to the 300Ω FM antenna terminals. Where the 75Ω unbalanced type is used and wired through a distributor, it is necessary to convert 75Ω to 300Ω by the use of a 300-ohm converter.

The farther you live from broadcasting stations, the greater difference the choice and positioning of an outdoor FM antenna makes in the quality of reception. The properties of FM broadcast signals are such that merely extending the length of the antenna does not increase sensitivity. What is more important is its direction and height, which should be determined so as to afford the best reception while actually listening to a broadcast.

FM Radio Reception

To receive FM broadcasts:

1. Turn the SELECTOR to FM AUTO.
2. Set the MODE switch to STEREO.
3. Push the POWER switch on and the dial scales are illuminated in green.
4. Select the desired station on the FM tuning dial scale with the tuning knob, while watching the tuning meter. The station is correctly tuned when the tuning meter pointer swings to the right as far as it will go. The FM STEREO indicator automatically lights up when a stereo program is received. During mono reception, it remains unlit.
5. In stereo mode, balance the sound levels in the right and left channels with the VOLUME knobs.
6. Operate all other controls and switches to suit taste and room acoustics.

AM Radio Reception

To receive AM broadcasts:

1. Turn the SELECTOR to AM.
2. Set the MODE switch to either MONO or STEREO position.
3. Push the POWER switch on and the dial scales

are illuminated in green.

4. Tune in the desired station by turning the tuning knob for the maximum deflection of the

tuning meter pointer.

5. Use all other controls and switches to suit taste and room acoustics.

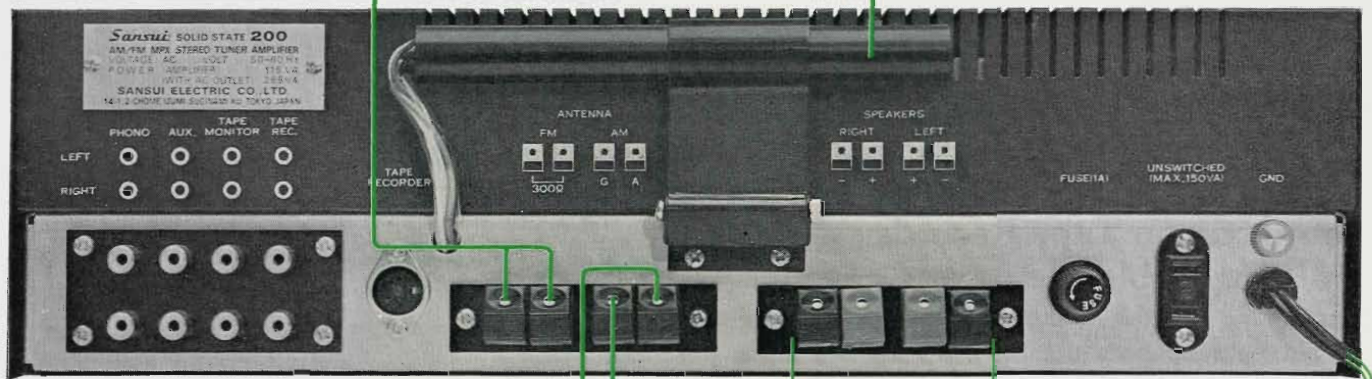
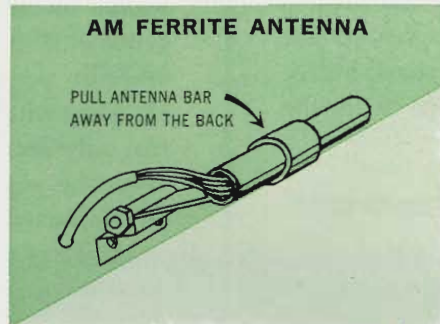
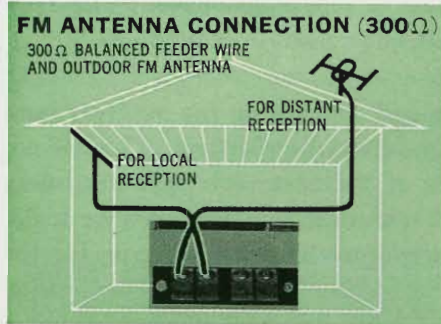

SEE "SPEAKER CONNECTIONS"

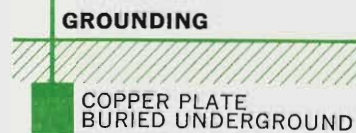
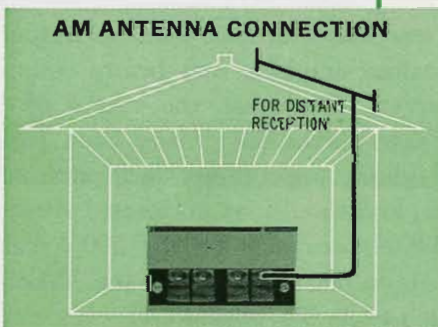

OPERATION

— TAPE PLAYBACK — TAPE RECORDING

TAPE RECORDERS

Tape recorders can be connected to record from, and playback through, the amplifier. But a tape deck cannot be used with the 200. For use with a tape recorder having its own playback preamplifier as well as separate recording and playback heads, the 200 can compare the recorded tape with the program source.

Connecting a Tape Recorder with a DIN Connector Cable

If the DIN connector cable is not yet connected to your tape recorder, insert the DIN connector at one of its ends into the DIN socket on the recorder first; then, insert the one on the other end into a similar socket marked TAPE RECORDER on the rear of the 200. The DIN connection system, based on the German DIN Standards and designed to simplify interconnections between the tape recorder and amplifier, enables tape recording and playback merely by plugging a cable with 5-pin connectors into their respective sockets.

Connecting a Tape Recorder with Pin Plug Cables

If your tape recorder lacks the DIN socket and only has pin jacks, connect it to the 200 with two pairs of shielded cables having a pin plug on each end, as follows:

To Record—Connect the right and left channel input jacks of the recorder to the RIGHT and LEFT TAPE REC. jacks on the rear of the 200 with a pair of such cables. If the recorder is a monophonic one, it may be connected to either right or left jack.

To Play—Connect the right and left channel output jacks of the recorder to the RIGHT and LEFT TAPE MON. jacks with another pair of such cables. Again use only one jack for a monophonic tape recorder.

Tape Monitoring

To record a tape and monitor the recorded tape almost simultaneously, the recorder must be connected by the use of pin plug cables. The DIN connectors do not allow such operation.

NOTE:

- 1) The switches and controls on the receiver control only the sound from the speakers. They do not affect the signals at the receiver's tape recording terminals, which are therefore recorded in a flat state. Thus, to monitor the recorded tape for the purpose of checking on the quality of recording, keep the various switches and controls on the receiver neutral (flat).
- 2) Whenever possible, avoid recording from microphones placed in front of the speaker(s), as it will considerably impair the tone quality. Instead, feed the signals from the receiver's tape recording terminals direct into the input terminals of the recorder.
- 3) The machine referred to as a tape recorder in this section includes only that kind of tape recorder which contains a playback preamplifier.
- 4) Tape monitoring is possible only with a tape recorder having three heads (erase head, plus separate record and play heads).
- 5) Unless you are recording a tape and want to monitor it or playing back a recorded tape, be sure to keep the TAPE MONITOR switch in the OFF position.
- 6) A tape deck does not have a playback preamplifier, and its output is delivered direct from its playback head. So if you want to connect a tape deck to the 200, it is essential that you feed its output to a separate equalizer amplifier first before coupling it to the receiver. In contrast, the output of a tape recorder or tape player has already been passed through a playback preamplifier incorporating such an amplifier, and should be connected direct to the TAPE MON. terminals on the 200's rear panel. To hear it, do not forget to set the TAPE MONITOR switch to its ON position.

Recording with a Tape Recorder

To record a tape on a tape recorder:

1. Set the SELECTOR to the desired program source (either PHONO, FM AUTO, AM or AUX).
2. Set the MODE switch to either STEREO or MONO, depending on the type of tape recorder used.
3. Make appropriate settings of controls and switches on the tape recorder.
4. Use other pertinent controls and switches on the

receiver, as required.

Playing a Recorded Tape

To play back a recorded tape on a tape recorder:

1. Set the TAPE MONITOR switch to its ON position.
2. Make appropriate settings of controls and switches on the tape recorder.
3. Use all other pertinent controls and switches on the receiver to suit taste and room acoustics.

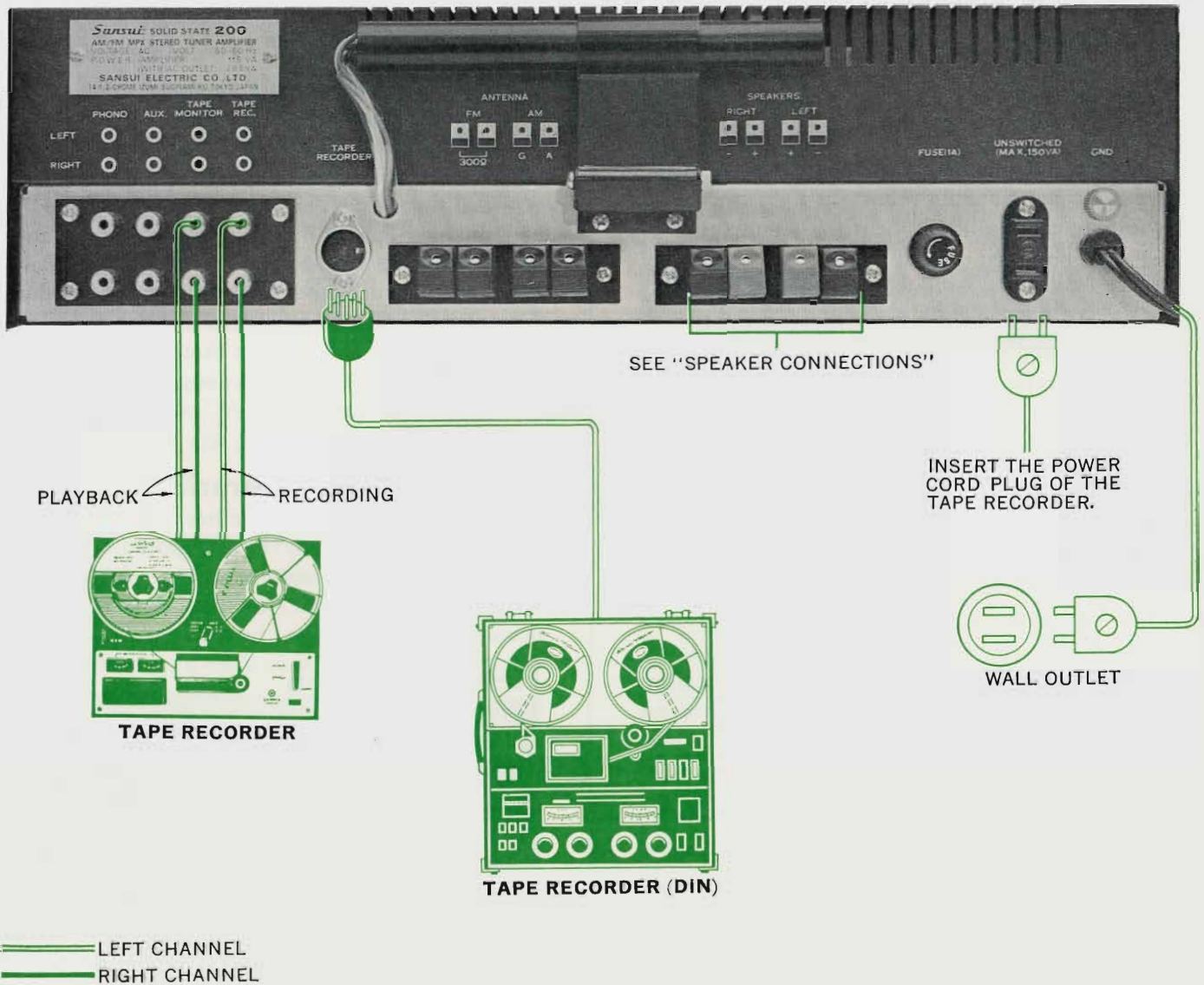

How to Eliminate Unpleasant Noise on Broadcast Bands

AM Band:

If you live far from broadcast stations, in the mountains or in a valley where it is difficult for radio signals to reach, inside a ferroconcrete building, or in an area where a number of large ferroconcrete buildings are crowded together, your 200 as it is may fail to provide really clear, noise-free reception of AM broadcasts. This situation can be corrected to a great extent by connecting a PVC wire to the AM antenna terminal on the receiver's rear panel and spreading it along a wall or the ceiling of room. If this should fail to reduce noise sufficiently or give you satisfactory sensitivity, and especially if you live inside a ferroconcrete building, erect an outdoor antenna a short distance away from the wall of the building. Further, some types of noise may be heard only at certain hours of the day or with only certain broadcast stations. This is usually due to the unique properties of AM broadcast signals, and can often be remedied by grounding the receiver or reversing the inserted position of the power cord plug.

FM Band:

The noise that you may hear with FM broadcasts is generally attributable to two causes. It may be caused by insufficient signal inputs into the antenna, or it may be produced by external electrical appliances. To eliminate or reduce such noise, follow these directions:

- 1) The antenna cannot receive sufficient signal inputs if it is improperly positioned or if broadcast stations are very distant. If you are using the dipole feeder antenna which comes with the receiver as instructed on page 7 under **FM Antennas**, try changing its position and see if you can obtain better sensitivity and reduce noise.
- 2) If the above measure fails to cut noise drastically, try installing an indoor TV antenna for greater sensitivity, or, better yet, erect an exclusive FM antenna (or TV antenna) outdoors in the position

which gives you the best reception. If one antenna is to be shared both for TV and FM radio receptions through the use of a splitter, make certain the TV reception is not affected.

3) Merely extending the length of the antenna or spreading it around many corners may sometimes increase noise.

4) With FM broadcasts, the transmitting condition of each station (such as the efficiency of the station's output antenna) has a great bearing upon the sensitivity. This may result in a situation where station A is received quite clearly, but station B is barely audible.

Noise Persistent on All Bands:

Other types of noise than those described may be heard at certain hours of the day, especially in an area where a number of ferroconcrete buildings are crowded together. These are usually produced by electrical appliances in those buildings, and can be easily distinguished from the types of noise described above because of their relationship with the hours. The situation can be corrected if it is an electrical appliance in your own house that is producing the noise. Simply attach a noise suppressor to that appliance. Or attach it to the AC power source of the receiver itself.

FM Multiplex Separation

The FM multiplex separation has been pre-adjusted at the factory, but may be readjusted, if desired. To readjust, turn the separation control VR located in the chassis so that the desired separation is achieved with FM stereo broadcasts.

Heat Dissipation

Transistors being relatively sensitive to heat, careful consideration has been given in designing the 200 to the efficiency of heat dissipation from the rear panel. For this reason, it is strongly recommended not to place anything on top of the receiver, encase it in a tightly closed box or operate it in direct sunlight. If either of these conditions cannot be avoided, take special care to increase the heat dissipation, or it may eventually lead to a breakdown.

If Booming Noise is Heard When Playing a Record....

Unpleasant booming hum or howling noise may be heard when playing a record or a recorded tape. This is almost invariably due to one of these reasons:

- 1) If the phonograph is placed directly on a speaker enclosure or very close to it, the vibration of the speaker will be transmitted to the phonograph, resulting in a booming phenomenon called howling. This can be easily corrected by separating the phonograph away from the phonograph or placing a thick cushion underneath the phonograph.
- 2) Booming noise is produced if the phonograph or tape recorder is connected with wires or cables other than shielded cables.
- 3) If neither of the above reasons applies, check the connections of various cable. Shielding wire and conductor of a shielded cable may be conversely soldered to a pin plug; the phonograph motor may not be grounded, or the grounding of its tonearm may be incomplete. In either case, unpleasant booming noise could result.

Connection of Additional Components

To connect such audio components as a tape recorder or phonograph, be sure to use thick, shielded cables which distribute only a minimum capacitance. The use of ordinary lamp cord usually results in picking up hum.

The length of such cable should not exceed 6 or 7

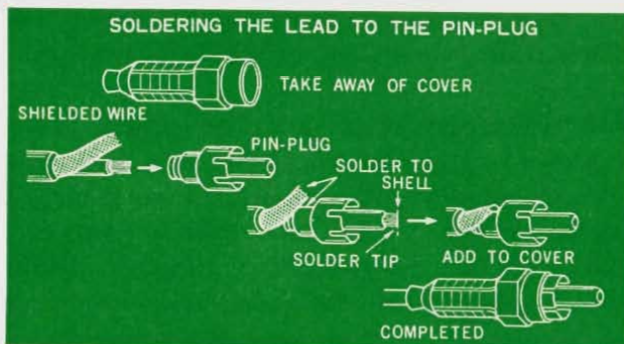

feet. The longer they are, the more the high frequencies of the program is attenuated.

To connect a monophonic component, use either the right or left channel terminal, whichever is easier to connect.

Grounding

Connect one end of a piece of PVC wire or enameled wire to the antenna terminal marked G, attach a small copper plate or bar to the other end and bury it deep under the ground. Whenever an external antenna is attached to the receiver, the receiver should be grounded in this manner.

Or also, it may be grounded by the use of the "GND" terminal. Attach a piece of PVC wire to it and bury it underground in the manner described above. This usually helps to prevent the audio amplifier from picking up noise, and also considerably cuts down noise on the broadcast bands.

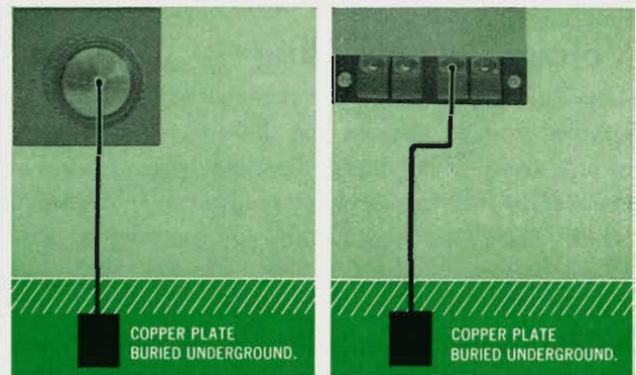

Power Handling Capacity of Speakers

Most speaker specifications include a maximum power rating. This rating, in watts, is not to be confused with required amplifier power. It is, rather, the maximum power which may be applied to the speaker for any length of time without actually damaging it. If the speaker with relatively small capacity is connected to the amplifier, it may be damaged at high listening levels.

MAINTENANCE

AC Outlet

One AC outlet is provided on the receiver's rear panel, and can be used like any other outlet for AC house current. Plug a phonograph or tape recorder into this outlet for power supply.

The outlet has a maximum capacity of 150VA, and is not controlled by the POWER switch on the receiver's front panel.

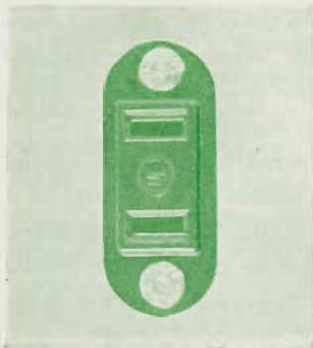

Voltage Selector Plug

The Voltage Adjustor on the rear of the chassis enables you to operate the 200 at correct voltage in any areas. The voltage has been pre-adjusted at the factory, but can be easily readjusted as follows:

STEP I Set arrow of main voltage selector plug to required voltage: 100, 110, 117, 127, 220, 230, 240 or 250 volts.

STEP II If numerals of voltage are printed in red, set arrow of adjacent sub V.S. plug to position marked red. If they are printed in white, set arrow to position marked white.

NOTE: The Voltage Adjustor can be used to eliminate the trouble caused by the considerable voltage fluctuation. In this case, it should be set to the peak voltage.

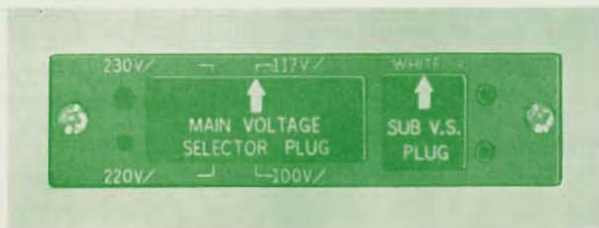

Should the Power Fuse Blow....

If the receiver should fail to turn on and you think it is because the power fuse has blown, remove the power cord from its wall outlet, unscrew and take out the fuse holder on the rear panel to see if it has blown. If it has, replace it with a 1A glass-tubed fuse. Using thin wire or a fuse of a different capacity as a stop-gap measure is very dangerous and should be absolutely avoided.

If the fuse has blown because of a trouble in the receiver, be sure to find and eliminate it first before replacing the fuse. Should the new fuse blow when the POWER switch is pushed, it is very likely that the power amplifier circuit is at fault and it should be repaired.



Should a Quick-acting Fuse Blow..

The expensive silicon power transistors in the 200 are safely protected by a pair of quick-acting fuses in the right and left channels. Should the output circuit be short-circuited (e.g., at speaker terminals) for some reasons or should an overcurrent from the input circuit flow into the power transistors, one or both of these quick-acting fuses will instantly blow and the sound will be cut off. If this happens, shut off the power supply immediately, discover and eliminate the cause, then replace the blown fuses.

Replacing Quick-acting Fuses

If one or both quick-acting fuses should blow, replace them with 1.0A quick-acting fuses (supplied). Never use other kinds of fuse, or the silicon power transistors may be damaged in the future. Before replacing be sure to discover and eliminate the cause of the blowout.

SPECIFICATIONS

AUDIO SECTION

POWER OUTPUT:

MUSIC POWER (IHF):	17W (at 4 ohms load) 14W (at 8 ohms load)
CONTINUOUS POWER:	6.5/6.5W (at 4 ohms load) 5/5W (at 8 ohms load)

TOTAL HARMONIC DISTORTION:

less than 1% at rated output

POWER BANDWIDTH (IHF): 30 to 25,000Hz

FREQUENCY RESPONSE: (at normal listening level)

AUX OVERALL: 25 to 30,000Hz \pm 2dB

CHANNEL SEPARATION: (at 1,000Hz rated output)

PHONO: better than 40dB

AUX: better than 40dB

HUM AND NOISE (IHF)

PHONO: better than 65dB

AUX: better than 70dB

INPUT SENSITIVITY: (at 1,000Hz rated output)

PHONO: 3mV (50k ohms)

AUX: 180mV (100k ohms)

TAPE MON (PIN): 180mV (100k ohms)

TAPE RECORDER (DIN): 180mV (100k ohms)

RECORDING OUTPUT

TAPE REC (PIN): 180mV

TAPE RECORDER (DIN): 30mV

LOAD IMPEDANCE: 4 to 16 ohms

DAMPING FACTOR: 35 at 8 ohms load

EQUALIZER PHONO: RIAA, NF type

TONE CONTROLS

BASS: \pm 11dB at 50Hz

TREBLE: \pm 8dB at 10,000Hz

LOUDNESS CONTROL: +8dB at 50Hz, +3dB at 10,000Hz
(Volume Control at -30dB)

SWITCHES

MODE: STEREO, MONO

TAPE MONITOR: OFF, ON

SELECTOR: PHONO, FM AUTO, AM,
AUX

OTHER SPECIAL FEATURES:

DIN Connector for Tape Recorder, Direct Tape Monitor,
Headphone Jack.

TUNER SECTION

FM

TUNING RANGE: 88 to 108MHz

SENSITIVITY (20dB quieting): 2.3 μ V
(IHF): 5.5 μ V

HARMONIC DISTORTION: 1%

SIGNAL TO NOISE RATIO: better than 50dB

SELECTIVITY: better than 35dB at 98MHz

CAPTURE RATIO (IHF): 3.5dB

IMAGE FREQUENCY REJECTION:

better than 55dB at 98MHz

IF REJECTION: better than 65dB at 98MHz

SPURIOUS RESPONSE REJECTION:

better than 65dB at 98MHz

SPURIOUS RADIATION: less than 34dB

ANTENNA INPUT IMPEDANCE:

300 ohms balanced

FM STEREO SEPARATION: better than 30dB

AM

TUNING RANGE: 535 to 1,605 kHz

SENSITIVITY: 51dB/m at 1,000 kHz (bar
antenna)

IMAGE FREQUENCY REJECTION:

better than 30dB at 1,000 kHz

IF REJECTION: better than 45dB

SELECTIVITY: better than 20dB

OTHER SPECIAL FEATURES

FM Linear Scale Dial, Signal Strength Meter, Flywheel
Tuning, AM Ferrite Bar Antenna, FM Stereo Auto, FM
SCA Filter.

TRANSISTORS AND DIODES

TRANSISTOR: 29 FET: 1

VARISTORS: 2 DIODES: 14

POWER REQUIREMENTS

POWER VOLTAGE: 100, 110, 117, 127, 220,
230, 240, 250V 50/60Hz

POWER CONSUMPTION: 45VA (Max Signal)

DIMENSIONS: 15-3/4"W, 4-3/4"H,
11"D

WEIGHT: 13.2 lbs.

* All rights reserve specifications subject to change without notice.

SCHEMATIC DIAGRAM

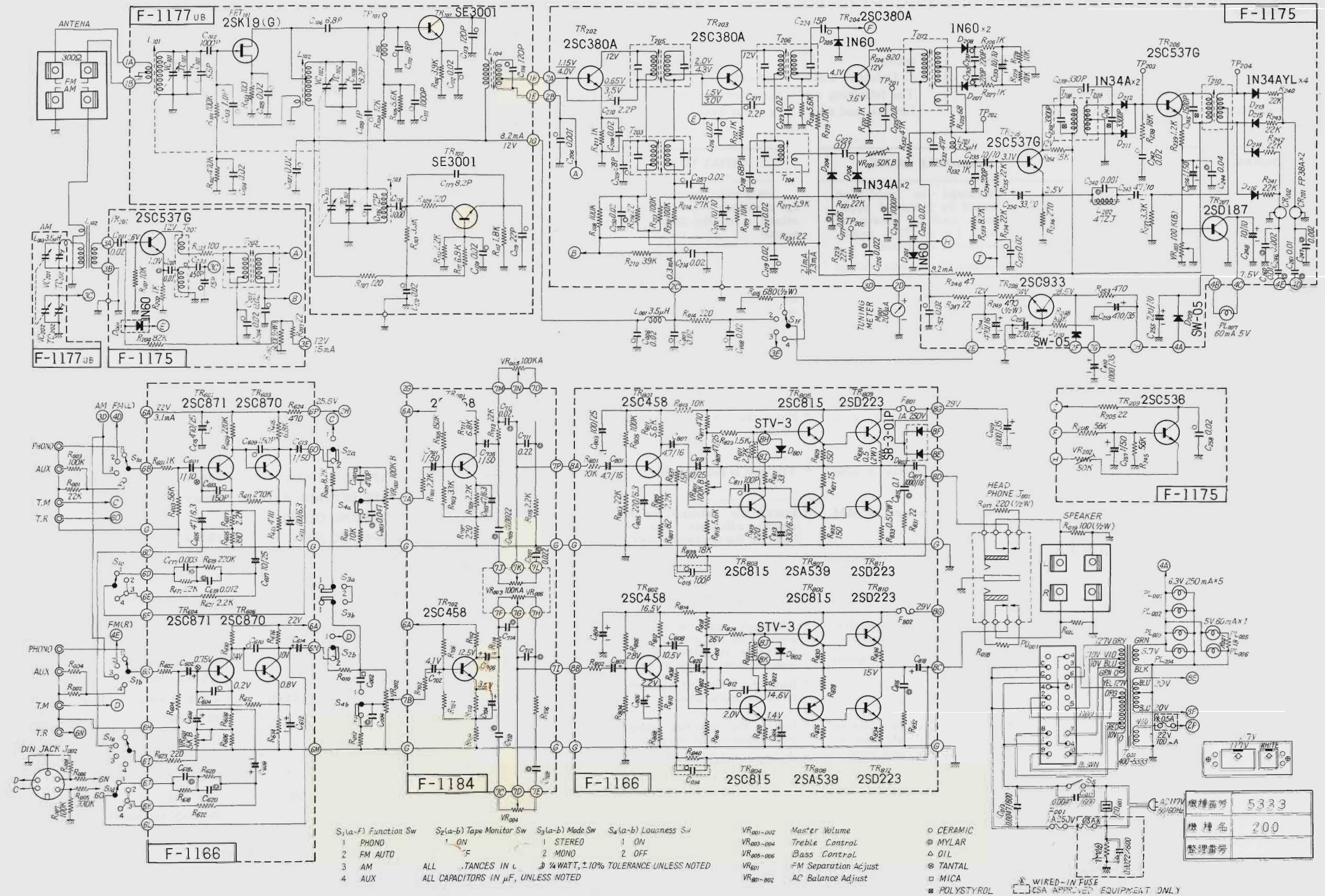

- S_{1(a-f)} Function Sw
 1 PHONO
 2 FM AUTO
 3 AM
 4 AUX
- S_{2(a-b)} Tape Monitor Sw
 ON
 OFF
- S_{3(a-b)} Mode Sw
 1 STEREO
 2 MONO
- S_{4(a-b)} Loudness Sw
 1 ON
 2 OFF
- S₅
- ALL TAPANCES IN μ 3/4 WATT, $\pm 10\%$ TOLERANCE UNLESS NOTED
 ALL CAPACITORS IN μ F, UNLESS NOTED

- VR₀₀₁₋₀₀₂ Master Volume
 VR₀₀₃₋₀₀₄ Treble Control
 VR₀₀₅₋₀₀₆ Bass Control
 VR₆₀₁ FM Separation Adj. just
 VR₈₀₁₋₈₀₂ AC Balance Adj. just

- CERAMIC
 ● MYLAR
 △ OIL
 □ TANTAL
 □ MICA
 ■ POLYSTYROL

* WIRED-IN FUSE
 [] CSA APPROVED EQUIPMENT ONLY

機種番号	5333
機種名	200
整理番号	

TROUBLESHOOTING CHART

If the amplifier is otherwise operating satisfactorily, the more common causes of trouble may generally be attributed to the following:

1. Incorrect connections or loose terminal contacts. Check the speakers, record player, tape recorder, antenna and line cord.
2. Improper operation. Before operating any audio com-

ponent, be sure to read the manufacturer's instructions.

3. Improper location of audio components. The proper positioning of components, such as speakers and turntable, is vital to stereo.
4. Defective audio components.

The following are some other common causes of malfunction and what to do about them.

PROGRAM	SYMPTOM	PROBABLE CAUSE	WHAT TO DO
AM,FM or MPX reception	A. Constant or intermittent noise heard at times or in a certain area	<ul style="list-style-type: none"> * Discharge or oscillation caused by electrical appliances, such as fluorescent lamp, TV set, D.C. motor, rectifier or oscillator * Natural phenomena, such as atmospherics, statics or thunderbolts * Insufficient antenna input due to ferroconcrete wall or long distance from the station * Wave interference from other electrical appliances 	<ul style="list-style-type: none"> * Attach a noise limiter to the electrical appliance causing the noise, or attach it to the amplifier's power source * Install an outdoor antenna and ground the amplifier to raise the signal-to-noise ratio * Reverse the power cord plug-receptacle connections * If the noise occurs at a certain frequency, attach a wave trap to the ANT. input * Keep the set at a proper distance from other electrical appliances
	B. The needle of the tuning meter does not move sharply	<ul style="list-style-type: none"> * Receiver is located in a weak signal area 	<ul style="list-style-type: none"> * Place the set for maximum signal strength
	C. The zero point of the meter diverges much	<ul style="list-style-type: none"> * Regional difference in field intensity 	<ul style="list-style-type: none"> * The unit is not at fault
AM reception	A. Noise heard at a particular time of a day, in a certain area or over part of dial	<ul style="list-style-type: none"> * Due to the nature of AM broadcasts 	<ul style="list-style-type: none"> * Install the antenna for maximum antenna efficiency. See "ANTENNA" in the operating instructions. * In some cases, the noise can be eliminated by grounding the amplifier or reversing the power cord plug-receptacle connections
	B. High-frequency noise	<ul style="list-style-type: none"> * Adjacent-channel interference or beat interference * TV set too close to audio system 	<ul style="list-style-type: none"> * Although such noise cannot be eliminated by the amplifier, it is advisable to adjust the TREBLE control from midpoint to left * Keep the TV set at a proper distance from the audio system
FM reception	A. Noisy	<ul style="list-style-type: none"> * Poor noise limiter effect or too low S/N ratio due to insufficient antenna input <p>Note: FM reception is affected considerably by transmission conditions of stations: power and antenna efficiency. As a result, you may receive one station quite well while receiving another station poorly</p>	<ul style="list-style-type: none"> * Install the antenna (supplied) for maximum signal strength * If this does not prove effective, use an outdoor antenna designed exclusively for FM. When you use a TV antenna for both TV and FM with a splitter, make sure TV reception is not affected * An excessively long antenna may cause noise

PPOGRAM	SYMPTOM	PROBABLE CAUSE	WHAT TO DO
FM reception (cont'd)	B. A series of pops	* Starting of an automobile engine	* Install the antenna and its lead-in wire at a proper distance from the road or raise the antenna input as described previously
	C. Distortion or no sound during reception	* Frequency swing	* Retune if station is not in tune due to mechanical vibration
	D. Tuning noise between stations	* This results from the nature of the FM reception. As the station signal becomes weak, the noise limiter effect is decreased, and the amplification of the limiter, in turn, is enlarged, generating a noise	* The unit is not at fault * Reduce the sound level, and then select the desired station
FM-MPX reception	A. Noise heard during FM-MPX reception but not heard during FM mono reception	* Weaker signal because the service area of the FM-MPX broadcast is only half that of the FM mono broadcast	* Install the antenna for maximum antenna input * Turn the TREBLE control from midpoint, left
	B. Channel separation gets worse during reception	* Excess heat	* Circulation of air is important to the amplifier. Be sure that air is flowing under the amplifier
	C. The stereo indicator blinks on and off even though stereo station is not received	* Interference	* The indicator is not at fault
Record' playing or tape playback	A. Hum or howling	* Record player placed directly on speaker * Wire other than shielded wire used * Loose terminal contact * Shielded wire too close to line cord, fluorescent lamp or other electrical appliances * Nearby amateur radio station or TV transmission antenna	* Place a cushion between the player and the speaker box or place them away from each other * The connecting shielded wire should be as short as possible * Turn the BASS control from midpoint, left * Consult the nearest Radio Regulatory Bureau
	B. Surface noise	* Worn or dusty record * Worn needle * Dusty needle * Improper needle pressure	* Replace or clean * Adjust the TREBLE control from midpoint, left * Correct needle pressure
All stereo programs	The outer and inner knobs of VOLUME control are not in the same position when equal sound comes from left and right channels	* It is important to adjust for equal sound from both channels. Both knobs should not always be set to the same position	* Set the MODE switch to MONO and then set the VOLUME knobs to a position where equal sound comes from both channels

DISASSEMBLE PROCEDURE / DIAL MECHANISM

REMOVING THE FRONT PANEL, BONNET AND BOTTOM BOARD

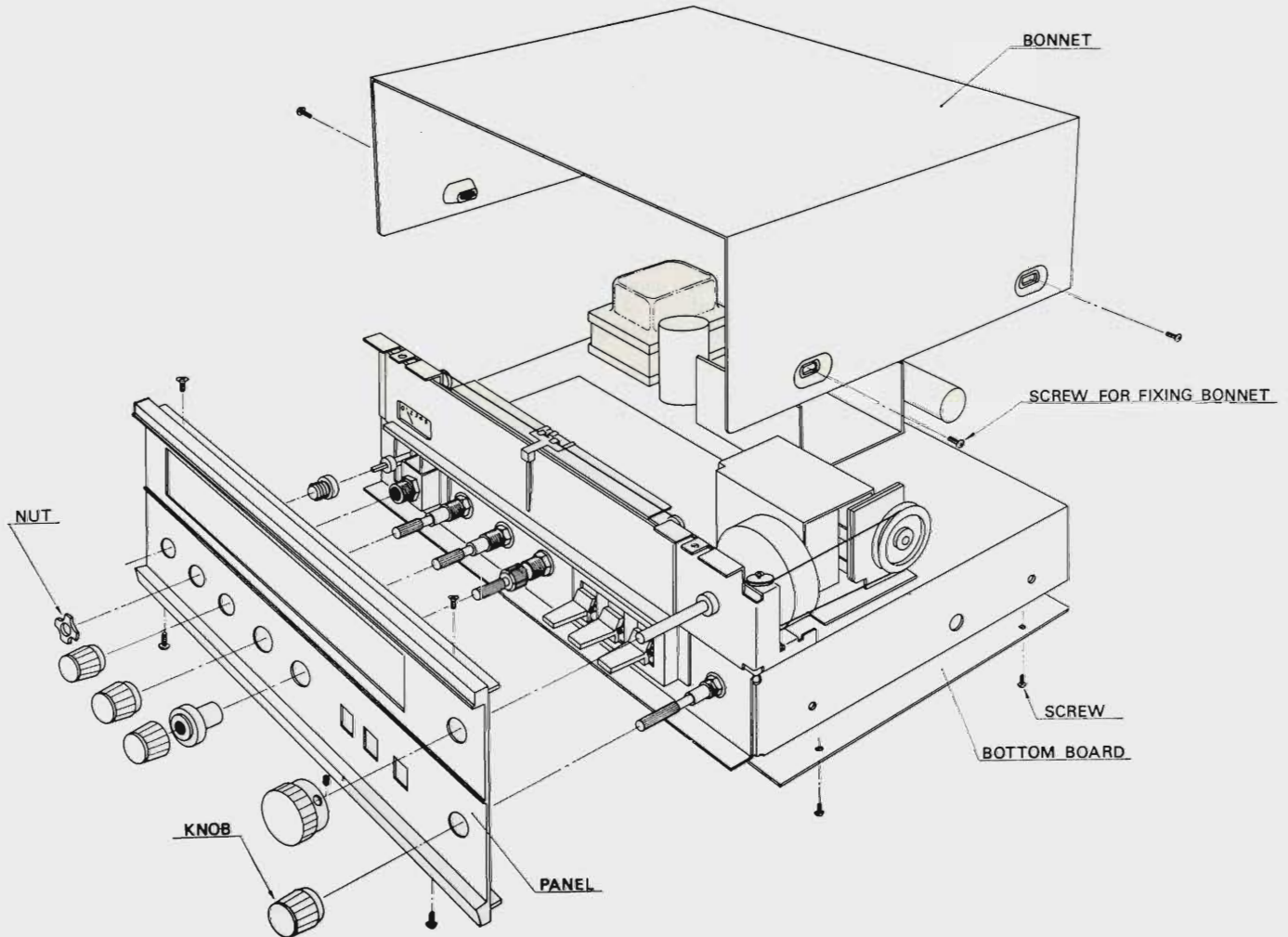

DIAL MECHANISM

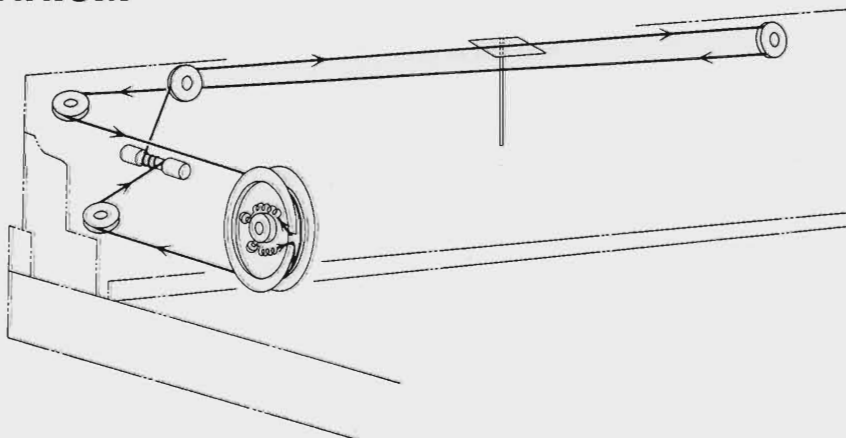

ALIGNMENT

TEST POINTS

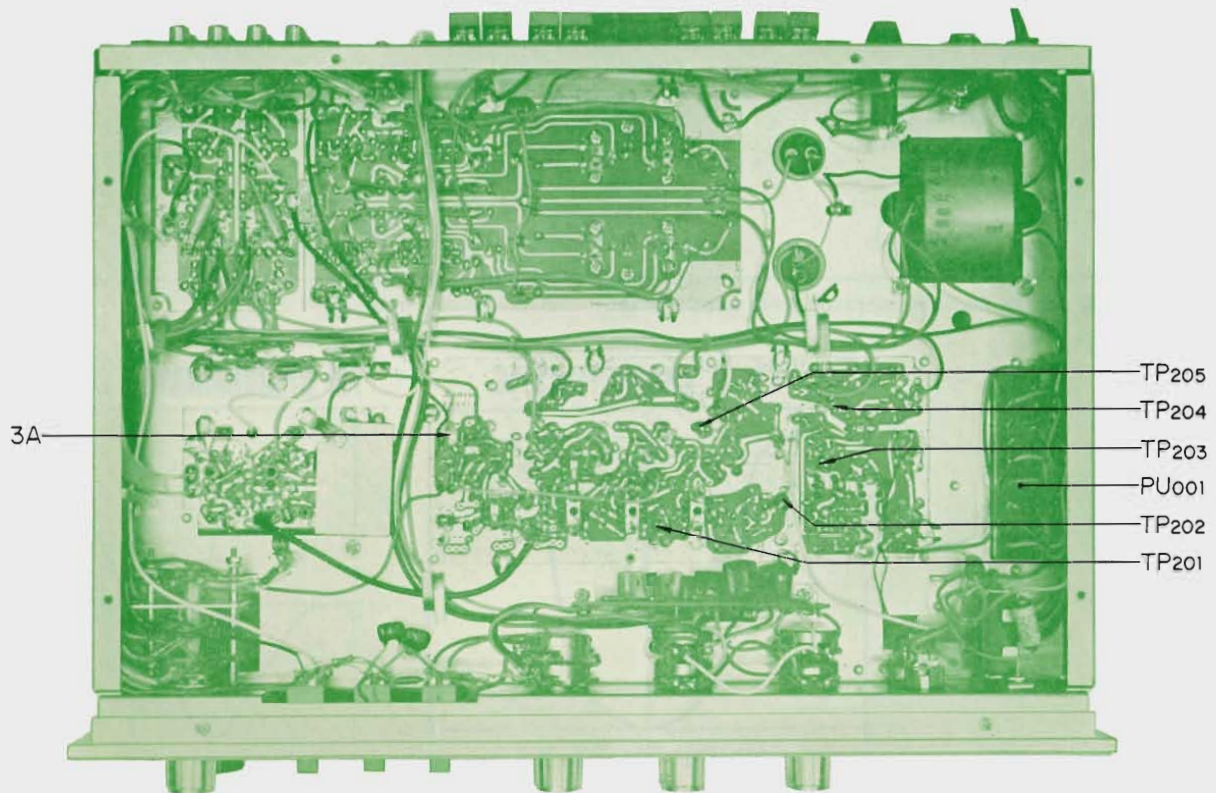
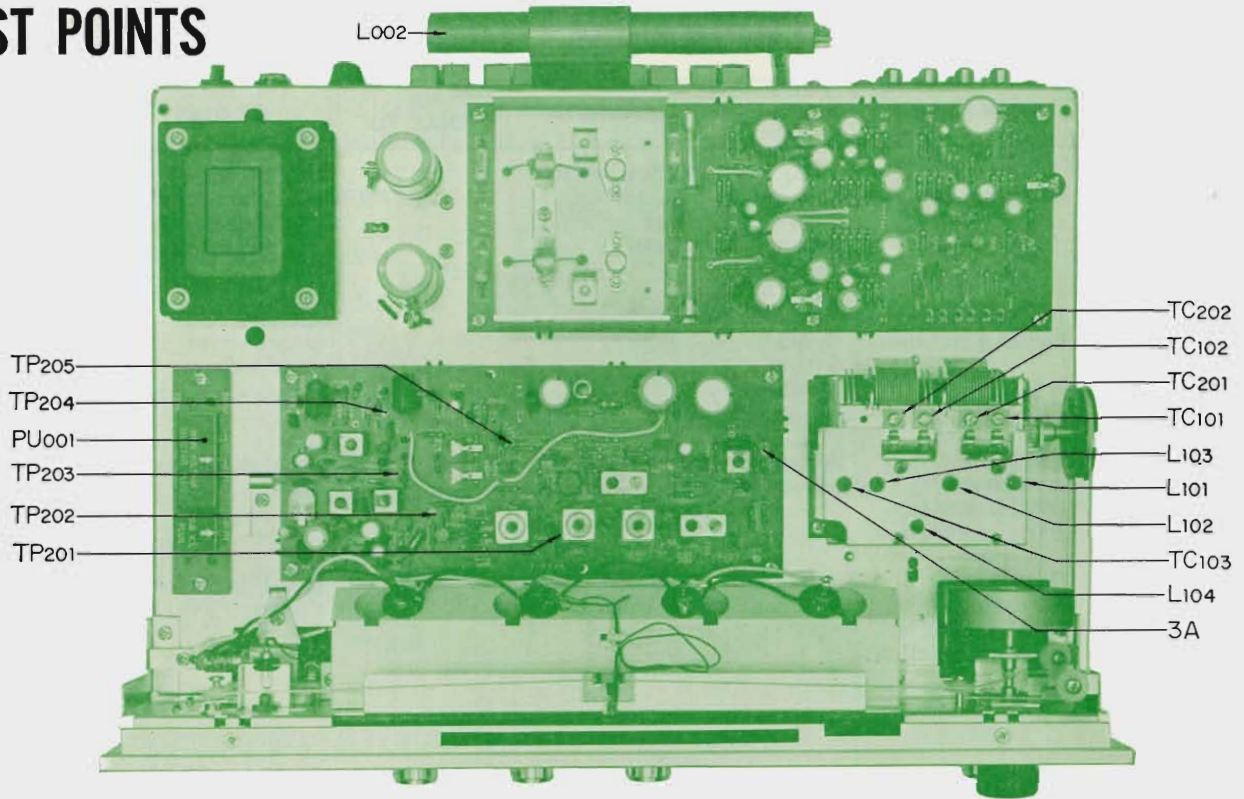

ALIGNMENT

FM TUNER ALIGNMENT PROCEDURE

STEP	ALIGN	GENERATOR	FEED SIGNAL TO	CONNECT	SET DIAL TO	ADJUST	ADJUST FOR
1.	IF transformer	10.7MHz sweep generator	TP ₁₀₁ through 0.02 μ F ceramic capacitor	Oscilloscope to TP ₂₀₁ through 0.02 μ F ceramic capacitor		Primary and secondary of IF transformers (L ₁₀₄ , T ₂₀₅ , T ₂₀₆)	Best wave form
2.	Discriminator	10.7MHz sweep generator	TP ₁₀₁ through 0.02 μ F ceramic capacitor	Oscilloscope to TP ₂₀₂		Primary and secondary of discriminator transformer (T ₂₀₇)	S curve
3.	Local oscillator	FM signal generator, 88MHz/400Hz, 100% modulation	Antenna terminals	Oscilloscope and V.T.V.M. to load terminals	88MHz	Local oscillator coil (L ₁₀₃)	Maximum
4.	Local oscillator	FM signal generator, 108MHz/400Hz, 100% modulation	Antenna terminals	Oscilloscope and V.T.V.M. to load terminals	108MHz	Local oscillator trimmer (TC ₁₀₃)	Maximum
5.	Reiterate 3 and 4.						
6.	Antenna and high-frequency amp. circuits	FM signal generator, 90MHz/400Hz, 100% modulation	Antenna terminals	Oscilloscope and V.T.V.M. to load terminals	90MHz	Antenna and RF coils (L ₁₀₁ , L ₁₀₂)	Maximum
7.	Antenna and high-frequency amp. circuits	FM signal generator, 106MHz/400Hz, 100% modulation	Antenna terminals	Oscilloscope and V.T.V.M. to load terminals	106MHz	Antenna and RF trimmers (TC ₁₀₁ , TC ₁₀₂)	Maximum
8.	Reiterate 6 and 7.						

NOTE: To align, set the signal generator level to minimum.

FM IF CHARACTERISTIC

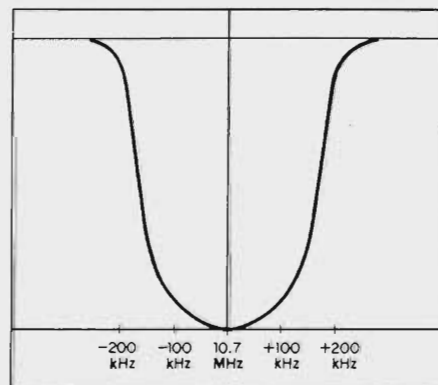

FM DISCRIMINATOR CHARACTERISTIC

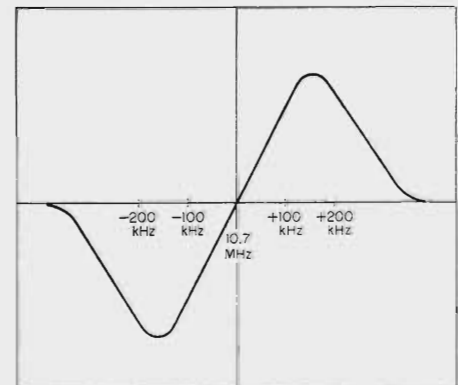

FM MULTIPLEX ALIGNMENT PROCEDURE

1. Do not attempt to align the Multiplex Circuit unless the following equipments are available:
 a. Stereo Signal Generator b. Oscilloscope c. AC. V.T.V.M. d. Audio Oscillator

STEP	ALIGN	GENERATOR	FEED SIGNAL TO	CONNECT	ADJUST	ADJUST FOR
1.	19kHz tuning coil	Stereo signal generator, 98MHz 40% modulation, L or R channel	Antenna terminals	V.T.V.M. and oscilloscope to TP ₂₀₈	T ₂₀₈ and T ₂₀₉	Maximum
2.	38kHz tuning coil	Stereo signal generator, 98MHz 40% modulation, L or R channel	Antenna terminals	V.T.V.M. and oscilloscope to TP ₂₀₄	T ₂₁₀	Maximum
3.	Separation	Stereo signal generator, 98MHz 40% modulation, L or R channel	Antenna terminals	V.T.V.M. and oscilloscope to load terminals	T ₂₁₀ VR ₆₀₁	(1) Minimum by turning T ₂₁₀ about 1/4, while watching R (or L) channel output (2) Best separation by turning VR ₆₀₁

ALIGNMENT

AM TUNER ALIGNMENT PROCEDURE

NOTE: To align, set the signal generator level to minimum.

STEP	ALIGN	GENERATOR	FEED SIGNAL TO	CONNECT	DIAL SETTING	ADJUST	ADJUST FOR
1.	I.F. transformer	455kHz sweep generator	3A terminals	Oscilloscope to T _{p205}		Primary and secondary of IF (T ₂₀₂ ~ ₂₀₄)	Best wave form
2.	Local oscillator	AM signal generator 535kHz 400Hz 30% modulation	Antenna terminals	Oscilloscope and V.T.V.M. to load terminals	535kHz	Local oscillator coil (T ₂₀₁)	Maximum
3.	Local oscillator	AM signal generator 1400kHz 400Hz 30% modulation	Antenna terminals	Oscilloscope and V.T.V.M. to load terminals	1400kHz	Local oscillator trimmer (TC ₂₀₂)	Maximum
4.	Reiterate 2 and 3						
5.	Antenna circuit	AM signal generator 600kHz 400Hz 30% modulation	Antenna terminals	Oscilloscope and V.T.V.M. to load terminals	600kHz	Ferrite bar antenna coil (L ₀₀₂)	Maximum
6.	Antenna circuit	AM signal generator 1400kHz 400Hz 30% modulation	Antenna terminals	Oscilloscope and V.T.V.M. to load terminals	1400kHz	Antenna trimmer (TC ₂₀₁)	Maximum
7.	Reiterate 5 and 6						

AM CHARACTERISTIC

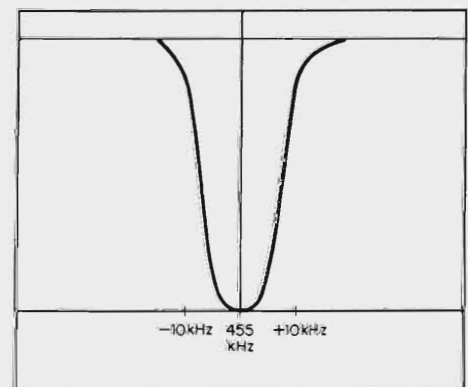

PRINTED CIRCUIT SHEETS AND PARTS LIST

X: Parts No Y: Parts Name Z: Position of Parts

tone control circuit <F-1184>

X	Y	Z
R701	2.2kΩ ±10% ¼W Carbon Resistor	C
R702	2.2kΩ ±10% ¼W Carbon Resistor	C
R703	33kΩ ±10% ¼W Carbon Resistor	C
R704	33kΩ ±10% ¼W Carbon Resistor	C
R705	150kΩ ±10% ¼W Carbon Resistor	B, C
R706	150kΩ ±10% ¼W Carbon Resistor	B
R707	220Ω ±10% ¼W Carbon Resistor	C
R708	220Ω ±10% ¼W Carbon Resistor	C
R709	2.2kΩ ±10% ¼W Carbon Resistor	C
R710	2.2kΩ ±10% ¼W Carbon Resistor	C
R711	6.8kΩ ±10% ¼W Carbon Resistor	B, C
R712	6.8kΩ ±10% ¼W Carbon Resistor	B
R713	22kΩ ±10% ¼W Carbon Resistor	B
R714	22kΩ ±10% ¼W Carbon Resistor	A, B
R715	2.2kΩ ±10% ¼W Carbon Resistor	A, B
R716	2.2kΩ ±10% ¼W Carbon Resistor	A
C701	1μF +100% -0% 50 WV Electrolytic Capacitor (Type 04)	C
C702	1μF +100% -0% 50 WV Electrolytic Capacitor (Type 04)	B
C703	47μF +100% -0% 6.3 WV Electrolytic Capacitor (Type 04)	C
C704	47μF +100% -0% 6.3 WV Electrolytic Capacitor (Type 04)	B
C705	1μF +100% -0% 50 WV Electrolytic Capacitor (Type 04)	B
C706	1μF +100% -0% 50 WV Electrolytic Capacitor (Type 04)	B
C707	0.022μF ±10% 50 WV Mylar Capacitor	B
C708	0.022μF ±10% 50 WV Mylar Capacitor	A
C709	0.0022μF ±10% 50 WV Mylar Capacitor	B
C710	0.0022μF ±10% 50 WV Mylar Capacitor	B
C711	0.22μF ±10% 50 WV Mylar Capacitor	A, B
C712	0.22μF ±10% 50 WV Mylar Capacitor	A
C713	0.022μF ±10% 50 WV Mylar Capacitor	B
C714	0.022μF ±10% 50 WV Mylar Capacitor	A
TR701	2SC458 B (030511-1)	B, C
TR702	2SC458 B (030511-1)	B

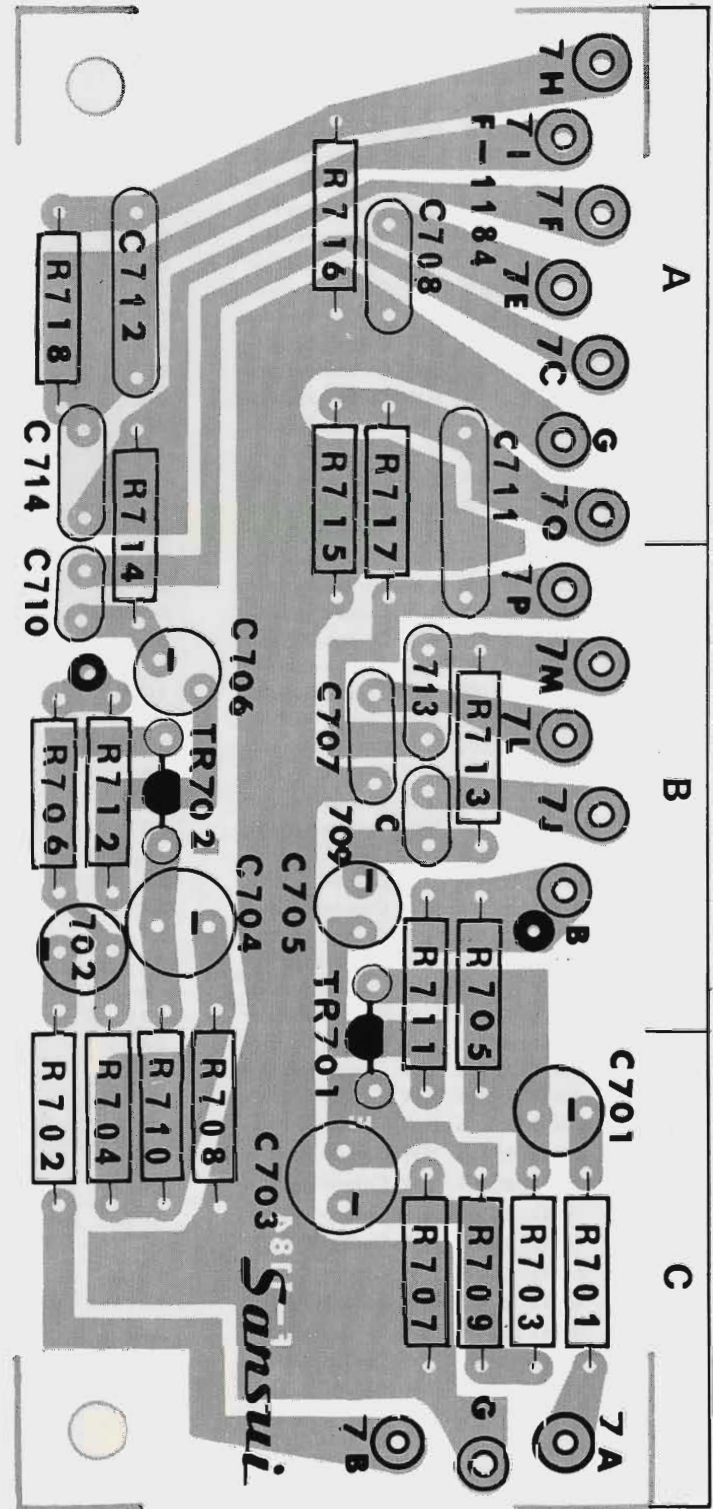

PRINTED CIRCUIT SHEETS AND PARTS LIST

AM FM MULTIPLEX CIRCUIT <F-1175>

X	Y	Z
R201	10kΩ ±10% ¼W Carbon Resistor	2 F
R202	1kΩ ±10% ¼W Carbon Resistor	2 F
R203	100Ω ±10% ¼W Carbon Resistor	2 F
R204	82kΩ ±10% ¼W Carbon Resistor	2 F, 3 F
R205	22Ω ±10% ¼W Carbon Resistor	1 B
R206	56kΩ ±10% ¼W Carbon Resistor	1 C
R207	22Ω ±10% ¼W Carbon Resistor	2 F, 3 F
R208	100kΩ ±10% ¼W Carbon Resistor	2 E
R209	10kΩ ±10% ¼W Carbon Resistor	2 E
R210	39kΩ ±10% ¼W Carbon Resistor	2 E
R211	1kΩ ±10% ¼W Carbon Resistor	2 E
R212	1kΩ ±10% ¼W Carbon Resistor	2 D
R213	100kΩ ±10% ¼W Carbon Resistor	2 D
R214	27kΩ ±10% ¼W Carbon Resistor	2 E
R216	22Ω ±10% ¼W Carbon Resistor	2 D
R217	3.9kΩ ±10% ¼W Carbon Resistor	2 D, 2 E
R218	5.6kΩ ±10% ¼W Carbon Resistor	2 D
R219	10kΩ ±10% ¼W Carbon Resistor	2 D, 3 D
R220	1kΩ ±10% ¼W Carbon Resistor	3 C, 3 D
R221	22kΩ ±10% ¼W Carbon Resistor	2 D
R223	22kΩ ±10% ¼W Carbon Resistor	2 C, 2 D
R224	820Ω ±10% ¼W Carbon Resistor	3 D
R225	68Ω ±10% ¼W Carbon Resistor	3 C
R226	1kΩ ±10% ¼W Carbon Resistor	3 C
R227	1kΩ ±10% ¼W Carbon Resistor	3 C
R228	10kΩ ±10% ¼W Carbon Resistor	3 B
R229	10kΩ ±10% ¼W Carbon Resistor	2 B, 2 C
R230	100kΩ ±10% ¼W Carbon Resistor	2 E
R231	22Ω ±10% ¼W Carbon Resistor	2 D
R232	1kΩ ±10% ¼W Carbon Resistor	3 B
R233	8.2kΩ ±10% ¼W Carbon Resistor	3 A
R234	22kΩ ±10% ¼W Carbon Resistor	3 A
R235	22kΩ ±10% ¼W Carbon Resistor	3 A
R236	270Ω ±10% ¼W Carbon Resistor	3 A
R237	3.3kΩ ±10% ¼W Carbon Resistor	1 A
R238	18kΩ ±10% ¼W Carbon Resistor	2 B
R239	1.2kΩ ±10% ¼W Carbon Resistor	2 A
R240	22kΩ ±10% ¼W Carbon Resistor	1 B
R241	22kΩ ±10% ¼W Carbon Resistor	1 A
R242	22kΩ ±10% ¼W Carbon Resistor	1 A
R243	22kΩ ±10% ¼W Carbon Resistor	1 A
R245	56kΩ ±10% ¼W Carbon Resistor	1 C
R246	47Ω ±10% ¼W Carbon Resistor	2 B
R247	22Ω ±10% ¼W Carbon Resistor	2 C
R248	3.9kΩ ±10% ¼W Carbon Resistor	1 D
R249	470Ω ±10% ½W Solid Resistor	1 D, 1 E
R251	820Ω ±10% ½W Solid Resistor	3 F
R252	47kΩ ±10% ¼W Carbon Resistor	3 B
R253	470Ω ±10% ¼W Carbon Resistor	1 E
R254	15kΩ ±10% ¼W Carbon Resistor	3 B
C201	0.02μF ±100% 25 WV Ceramic Capacitor	2 F
C202	0.01μF ±10% 50 WV Mylar Capacitor	2 F
C203	450pF ±10% 50 WV Mica Capacitor	2 F
C204	0.02μF ±100% 25 WV Ceramic Capacitor	3 F

X	Y	Z
C206	0.001μF ±100% 25 WV Ceramic Capacitor	3 E
C207	0.02μF ±100% 25 WV Ceramic Capacitor	2 E, 3 E
C208	0.02μF ±100% 25 WV Ceramic Capacitor	2 E, 3 E
C209	68pF ±100% 50 WV Ceramic Capacitor	2 E
C210	2.2pF ±100% 50 WV Ceramic Capacitor	3 E
C214	0.02μF ±100% 25 WV Ceramic Capacitor	2 E
C216	0.02μF ±100% 25 WV Ceramic Capacitor	2 D
C217	2.2pF ±10% 50 WV Ceramic Capacitor	3 D
C218	68pF ±10% 50 WV Ceramic Capacitor	2 D
C219	0.02μF ±100% 25 WV Ceramic Capacitor	2 D
C220	10μF ±100% 10 WV Electrolytic Capacitor (Type 04)	2 E
C221	0.02μF ±100% 25 WV Ceramic Capacitor	2 E
C222	0.01μF ±100% 25 WV Ceramic Capacitor	2 C
C223	0.02μF ±100% 25 WV Ceramic Capacitor	2 D
C224	15pF ±10% 50 WV Ceramic Capacitor	2 C
C225	0.02μF ±100% 25 WV Ceramic Capacitor	3 D
C226	0.022μF ±10% 50 WV Mylar Capacitor	1 C, 2 C
C227	0.006μF ±10% 50 WV Mylar Capacitor	2 D
C229	0.02μF ±100% 25 WV Ceramic Capacitor	2 B
C230	220pF ±10% 50 WV Ceramic Capacitor	3 C
C231	220pF ±10% 50 WV Ceramic Capacitor	3 C
C232	47pF ±10% 50 WV Ceramic Capacitor	3 C
C233	10μF ±100% 10 WV Electrolytic Capacitor (Type 04)	3 C
C234	200pF ±10% 50 WV Ceramic Capacitor	3 A, 3 B
C235	10μF ±100% 10 WV Electrolytic Capacitor (Type 04)	3 B
C236	33μF ±100% 10 WV Electrolytic Capacitor (Type 04)	3 B
C237	0.02μF ±100% 25 WV Ceramic Capacitor	1 B
C238	3300pF ±5% 50 WV Styrol Capacitor	3 B
C239	330pF ±10% 50 WV Ceramic Capacitor	2 A, 2 B
C240	0.001μF ±10% 50 WV Mylar Capacitor	3 A
C241	3300pF ±5% 50 WV Styrol Capacitor	2 A
C242	0.02μF ±100% 25 WV Ceramic Capacitor	2 B
C243	47μF ±100% 10 WV Electrolytic Capacitor (Type 04)	2 A, 1 A
C244	0.04μF ±10% 50 WV Mylar Capacitor	2 A
C245	1500pF ±5% 50 WV Styrol Capacitor	2 B
C246	0.002μF ±10% 50 WV Mylar Capacitor	1 A
C247	0.002μF ±10% 50 WV Mylar Capacitor	1 B
C248	10μF ±100% 10 WV Electrolytic Capacitor (Type 04)	2 A
C249	0.001μF ±10% 50 WV Mylar Capacitor	2 D
C250	0.02μF ±100% 25 WV Ceramic Capacitor	2 E
C251	0.02μF ±100% 25 WV Ceramic Capacitor	2 D
C252	0.02μF ±100% 25 WV Ceramic Capacitor	2 C
C253	220μF ±100% 25 WV Electrolytic Capacitor (Type 04)	1 D
C254	470μF ±100% 16 WV Electrolytic Capacitor (Type 04)	1 E
C255	220μF ±100% 10 WV Electrolytic Capacitor (Type 04)	3 A
C256	1μF ±100% 50 WV Electrolytic Capacitor (Type 04)	3 A
C257	1μF ±100% 50 WV Electrolytic Capacitor (Type 04)	1 C
C258	0.02μF ±100% 25 WV Ceramic Capacitor	1 C

X	Y	Z
C259	470 μ F $\pm 100\%$ 35 WV Electrolytic Capacitor (Type 04)	1 E, 1 F
C260	0.01 μ F $\pm 10\%$ 50 WV Mylar Capacitor	1 A
C261	0.01 μ F $\pm 10\%$ 50 WV Mylar Capacitor	1 B
TR201	2SC537 G (030544-2)	2 F
TR202	2SC380 A(R.O.Y) (030557,-1,-2)	3 E
TR203	2SC380 A(R.O.Y) (030557,-1,-2)	3 D
TR204	2SC380 A(R.O.Y) (030544-2)	3 D
TR205	2SC537 G (030544-2)	3 B
TR206	2SC537 G (030544-2)	2 B
TR207	2SD187 (Red) (030814)	2 A
TR208	2SC933 D, F (030561,-1)	1 D
TR209	2SC536 E (030515-4)	1 C
D201	IN60 (031033)	1 B
D204	IN34A (031040)	2 D
D205	IN60 (031033)	2 C
D206	IN34A (031040)	2 C
D207	IN60 (031033)	3 C
D208	IN60 (031033)	3 C
D209	SW-05-01 (031051)	3 A
D210	SW-05-01 (031051)	1 C
D211	IN34A (031040)	2 B
D212	IN34A (031040)	2 B
D213	IN34A(YL) (031040-1)	1 B
D214	IN34A(YL) (031040-1)	1 B
D215	IN34A(YL) (031040-1)	1 A
D216	IN34A(YL) (031040-1)	1 A
T201	AM OSC (422006)	2 F
T202	AM 455kHz IFT (423029)	3 E, 3 F
T203	AM 455kHz IFT (423026)	2 D, 2 E
T204	AM Detector Transformer (423028)	2 D
T205	FM 10.7MHz IFT (423546)	3 E
T206	FM 10.7MHz IFT (423546)	3 D
T207	FM Detector Transformer (423514)	3 C
T208	19kHz Tuning Coil (424030)	2 B
T209	19kHz Tuning Coil (424030)	2 A
T210	38kHz Tuning Coil (424031)	2 A
VR201	50k Ω B AM Meter Adjustor (103020)	2 C
VR202	50k Ω B FM Meter Adjustor (103020)	2 C
VR203	100k Ω (B)Stereo Indicator Adjustor(103034)	3 A
CR201	FP-38A (080008)	1 B
CR202	FP-38A (080008)	1 A
L201	3.5 μ H (429001-1)	3 B
L202	4.7mH(J) (490003)	3 A

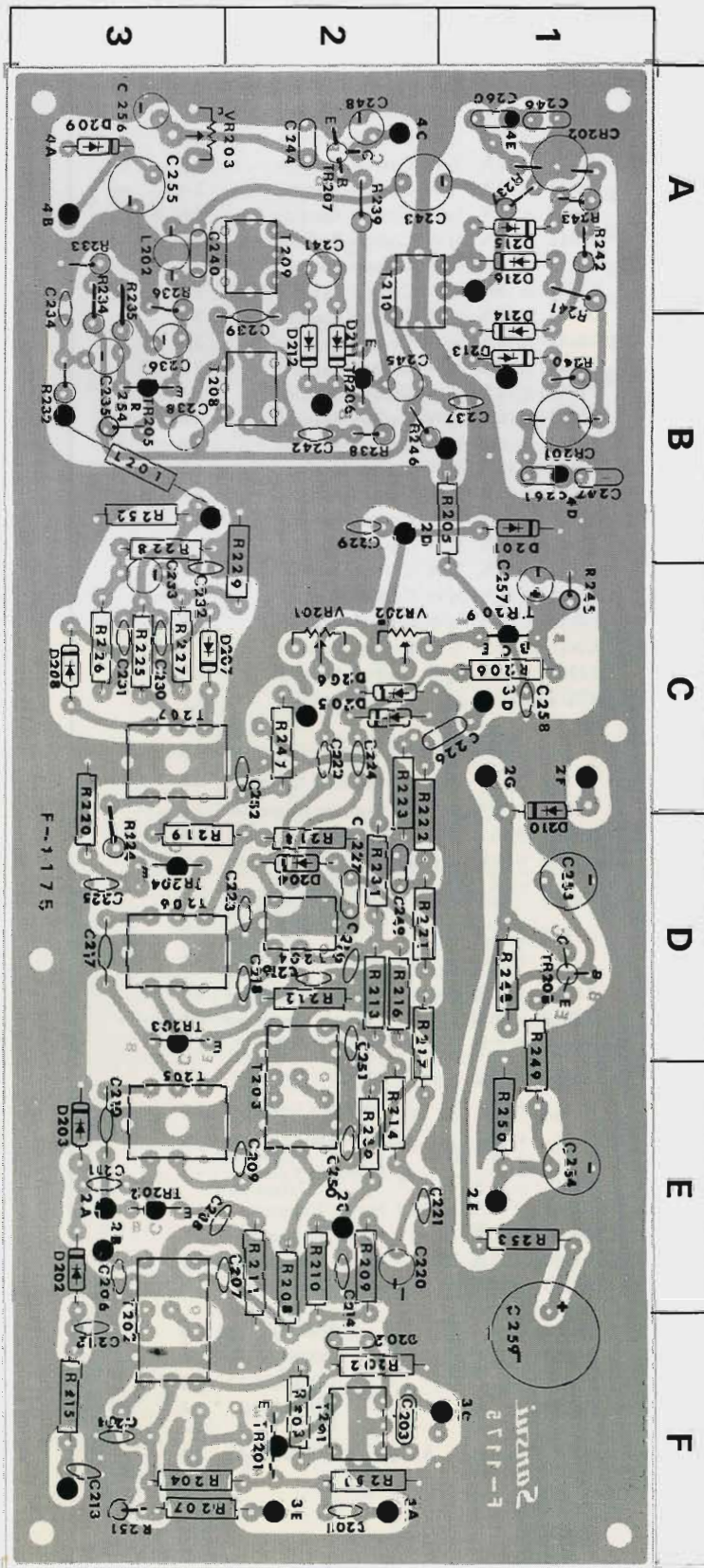

PRINTED CIRCUIT SHEETS AND PARTS LIST

EQUALIZER CIRCUIT <F-1166>

X	Y	Z
R601	1k Ω \pm 10% $\frac{1}{4}$ W Carbon Resistor	3 B
R602	1k Ω \pm 10% $\frac{1}{4}$ W Carbon Resistor	3 A
R603	56k Ω \pm 10% $\frac{1}{4}$ W Carbon Resistor	3 B
R604	56k Ω \pm 10% $\frac{1}{4}$ W Carbon Resistor	3 A
R605	390 Ω \pm 10% $\frac{1}{4}$ W Carbon Resistor	2 B, 3 B
R606	390 Ω \pm 10% $\frac{1}{4}$ W Carbon Resistor	2 A, 3 A
R607	2.2k Ω \pm 10% $\frac{1}{4}$ W Carbon Resistor	2 B, 3 B
R608	2.2k Ω \pm 10% $\frac{1}{4}$ W Carbon Resistor	2 A, 3 A
R609	220k Ω \pm 10% $\frac{1}{4}$ W Carbon Resistor	3 B
R610	220k Ω \pm 10% $\frac{1}{4}$ W Carbon Resistor	3 A, 3 B
R611	270k Ω \pm 10% $\frac{1}{4}$ W Carbon Resistor	2 B, 3 B
R612	270k Ω \pm 10% $\frac{1}{4}$ W Carbon Resistor	2 A, 3 A
R613	470 Ω \pm 10% $\frac{1}{4}$ W Carbon Resistor	2 B
R614	470 Ω \pm 10% $\frac{1}{4}$ W Carbon Resistor	2 A
R615	6.8k Ω \pm 10% $\frac{1}{4}$ W Carbon Resistor	1 B, 2 B
R616	6.8k Ω \pm 10% $\frac{1}{4}$ W Carbon Resistor	1 A, 2 A
R617	22k Ω \pm 10% $\frac{1}{4}$ W Carbon Resistor	1 B
R618	22k Ω \pm 10% $\frac{1}{4}$ W Carbon Resistor	1 A
R619	220k Ω \pm 10% $\frac{1}{4}$ W Carbon Resistor	1 B
R620	220k Ω \pm 10% $\frac{1}{4}$ W Carbon Resistor	1 A
R621	2.2k Ω \pm 10% $\frac{1}{4}$ W Carbon Resistor	1 B
R622	2.2k Ω \pm 10% $\frac{1}{4}$ W Carbon Resistor	1 A
R623	220 Ω \pm 10% $\frac{1}{4}$ W Carbon Resistor	2 A
R624	470 Ω \pm 10% $\frac{1}{4}$ W Carbon Resistor	1 B
C601	1 μ F $\frac{+40}{-20}$ % 10 WV Tantalum Capacitor	3 B
C602	1 μ F $\frac{+40}{-20}$ % 10 WV Tantalum Capacitor	3 A
C603	150 pF \pm 10% 50 WV Ceramic Capacitor	3 B
C604	150 pF \pm 10% 50 WV Ceramic Capacitor	3 A
C605	47 μ F $\frac{+100}{0}$ % 6.3 WV Electrolytic Capacitor (Type 04)	2 B
C606	47 μ F $\frac{+100}{0}$ % 6.3 WV Electrolytic Capacitor (Type 04)	2 A
C607	10 μ F $\frac{+100}{0}$ % 25 WV Electrolytic Capacitor (Type 02)	2 B
C608	10 μ F $\frac{+100}{0}$ % 25 WV Electrolytic Capacitor (Type 02)	2 A
C609	150 pF \pm 10% 50 WV Ceramic Capacitor	2 B
C610	150 pF \pm 10% 50 WV Ceramic Capacitor	2 A
C611	100 μ F $\frac{+100}{0}$ % 6.3 WV Electrolytic Capacitor (Type 04)	2 B
C612	100 μ F $\frac{+100}{0}$ % 6.3 WV Electrolytic Capacitor (Type 04)	2 A
C613	1 μ F $\frac{+100}{0}$ % 50 WV Electrolytic Capacitor (Type 04)	2 B
C614	1 μ F $\frac{+100}{0}$ % 50 WV Electrolytic Capacitor (Type 04)	2 A
C615	470 μ F $\frac{+100}{0}$ % 25 WV Electrolytic Capacitor (Type 04)	3 A, 3 B
C617	0.003 μ F \pm 10% 50 WV Mylar Capacitor	1 B
C618	0.003 μ F \pm 10% 50 WV Mylar Capacitor	1 A
C619	0.012 μ F \pm 10% 50 WV Mylar Capacitor	1 B
C620	0.012 μ F \pm 10% 50 WV Mylar Capacitor	1 A
TR601	2SC871 E, F (0305471-1,-2)	3 B
TR602	2SC871 E, F (030547-1,2)	3 A
TR603	2SC870 F (030551-1)	2 B
TR604	2SC870 F (030551-1)	2 A
VR601	5k Ω B Separation Adjustor (103018-1)	2 A

AUDIO CIRCUIT <F-1166>

X	Y	Z
R801	10k Ω \pm 10% $\frac{1}{4}$ W Carbon Resistor	1 C
R802	10k Ω \pm 10% $\frac{1}{4}$ W Carbon Resistor	3 C
R803	22k Ω \pm 10% $\frac{1}{4}$ W Carbon Resistor	1 C
R804	22k Ω \pm 10% $\frac{1}{4}$ W Carbon Resistor	3 C
R805	100k Ω \pm 10% $\frac{1}{4}$ W Carbon Resistor	1 C, 2 C
R806	100k Ω \pm 10% $\frac{1}{4}$ W Carbon Resistor	2 C
R807	82 Ω \pm 10% $\frac{1}{4}$ W Carbon Resistor	1 C
R808	82 Ω \pm 10% $\frac{1}{4}$ W Carbon Resistor	3 C
R809	2.2k Ω \pm 10% $\frac{1}{4}$ W Carbon Resistor	1 C
R810	2.2k Ω \pm 10% $\frac{1}{4}$ W Carbon Resistor	3 C
R811	5.6k Ω \pm 10% $\frac{1}{4}$ W Carbon Resistor	1 C, 2 C
R812	5.6k Ω \pm 10% $\frac{1}{4}$ W Carbon Resistor	2 C
R813	10k Ω \pm 10% $\frac{1}{4}$ W Carbon Resistor	1 C, 2 C
R814	10k Ω \pm 10% $\frac{1}{4}$ W Carbon Resistor	2 C
R815	5.6k Ω \pm 10% $\frac{1}{4}$ W Carbon Resistor	1 C
R816	5.6k Ω \pm 10% $\frac{1}{4}$ W Carbon Resistor	3 C
R817	470 Ω \pm 10% $\frac{1}{4}$ W Carbon Resistor	1 C, 2 C
R818	470 Ω \pm 10% $\frac{1}{4}$ W Carbon Resistor	2 C
R819	220 Ω \pm 10% $\frac{1}{4}$ W Carbon Resistor	1 D
R820	220 Ω \pm 10% $\frac{1}{4}$ W Carbon Resistor	3 D
R821	33 Ω \pm 10% $\frac{1}{4}$ W Carbon Resistor	2 D
R822	33 Ω \pm 10% $\frac{1}{4}$ W Carbon Resistor	2 D
R823	1.5k Ω \pm 10% $\frac{1}{4}$ W Carbon Resistor	1 C, 2 C
R824	1.5k Ω \pm 10% $\frac{1}{4}$ W Carbon Resistor	2 C
R825	150 Ω \pm 10% $\frac{1}{4}$ W Carbon Resistor	1 C
R826	150 Ω \pm 10% $\frac{1}{4}$ W Carbon Resistor	3 D
R827	15 Ω \pm 10% $\frac{1}{4}$ W Carbon Resistor	1 D
R828	15 Ω \pm 10% $\frac{1}{4}$ W Carbon Resistor	3 D
R829	150 Ω \pm 10% $\frac{1}{4}$ W Carbon Resistor	1 C, 2 C
R830	150 Ω \pm 10% $\frac{1}{4}$ W Carbon Resistor	2 C
R831	22 Ω \pm 10% $\frac{1}{4}$ W Carbon Resistor	1 D
R832	22 Ω \pm 10% $\frac{1}{4}$ W Carbon Resistor	3 D
R833	0.5 Ω \pm 10% 2 W Wire-Wound Resistor	1 G, 2 G
R834	0.5 Ω \pm 10% 2 W Wire-Wound Resistor	2 G, 3 G
R835	0.5 Ω \pm 10% 2 W Wire-Wound Resistor	1 E, 2 E
R836	0.5 Ω \pm 10% 2 W Wire-Wound Resistor	2 E, 3 E
R837	15k Ω \pm 10% $\frac{1}{4}$ W Carbon Resistor	1 E, 2 E
R838	15k Ω \pm 10% $\frac{1}{4}$ W Carbon Resistor	2 D, 2 E
R839	18k Ω \pm 10% $\frac{1}{4}$ W Carbon Resistor	1 D, 2 D
R840	18k Ω \pm 10% $\frac{1}{4}$ W Carbon Resistor	2 D
C801	4.7 μ F $\frac{+100}{0}$ % 16 WV Electrolytic Capacitor (Type 04)	1 C
C802	4.7 μ F $\frac{+100}{0}$ % 16 WV Electrolytic Capacitor (Type 04)	3 C
C803	100 μ F $\frac{+100}{0}$ % 25 WV Electrolytic Capacitor (Type 04)	2 C
C804	100 μ F $\frac{+100}{0}$ % 25 WV Electrolytic Capacitor (Type 04)	2 C
C805	220 μ F $\frac{+100}{0}$ % 6.3 WV Electrolytic Capacitor (Type 04)	1 C
C806	220 μ F $\frac{+100}{0}$ % 6.3 WV Electrolytic Capacitor (Type 04)	3 C
C807	4.7 μ F $\frac{+100}{0}$ % 16 WV Electrolytic Capacitor (Type 04)	1 C
C808	4.7 μ F $\frac{+100}{0}$ % 16 WV Electrolytic Capacitor (Type 04)	3 C
C809	47 μ F $\frac{+100}{0}$ % 25 WV Electrolytic Capacitor (Type 04)	1 C
C810	47 μ F $\frac{+100}{0}$ % 25 WV Electrolytic Capacitor (Type 04)	3 C
C811	100 pF \pm 10% 50 WV Ceramic Capacitor	1 D
C812	100 pF \pm 10% 50 WV Ceramic Capacitor	3 D
C813	330 μ F $\frac{+100}{0}$ % 6.3 WV Electrolytic Capacitor (Type 04)	1 D

X	Y			Z
C814	330 μ F	+100% -0%	6.3 WV Electrolytic Capacitor (Type 04)	3D
C815	0.1 μ F	\pm 10%	50 WV Mylar Capacitor	1D
C816	0.1 μ F	\pm 10%	50 WV Mylar Capacitor	3D
C817	1000 μ F	+100% -0%	16 WV Electrolytic Capacitor (Type 04)	1D, 2D
C818	1000 μ F	+100% -0%	16 WV Electrolytic Capacitor (Type 04)	2D, 3D
C819	10 μ F	+100% -0%	25 WV Electrolytic Capacitor (Type 05)	2D
C820	10 μ F	+100% -0%	25 WV Electrolytic Capacitor (Type 04)	2D
TR801	2SC458	B.C	(030511-1,-2)	1C
TR802	2SC458	B.C	(030511-1,-2)	3C
TR803	2SC815	M	(030543-0)	1D
TR804	2SC815	M	(030543-0)	3D
TR805	2SC815	M	(030543-0)	2C
TR806	2SC815	M	(030543-0)	2C
TR807	2SA539	M	(030011-0)	1D
TR808	2SA539	M	(030011-0)	3D
TR809	2SD223	O.Y.G	(030823,-1,-2)	1F
TR810	2SD223	O.Y.G	(030823,-1,-2)	3F
TR811	2SD223	O.Y.G	(030823,-1,-2)	1G
TR812	2SD223	O.Y.G	(030823,-1,-2)	3G
D801	STV-3	Varistor	(034004)	1F, 1G
D802	STV-3	Varistor	(034004)	3F, 3G
D803	SB-3-01P		(031059)	2E
F801	1A 250V	Quick-acting Fuse	(043013)	1E, 2E
F802	1A 250V	Quick-acting Fuse	(043013)	2E, 3E
VR801	100k Ω	B AC Balance	(103034-1)	1D
VR802	100k Ω	B AC Balance	(103034-1)	3D

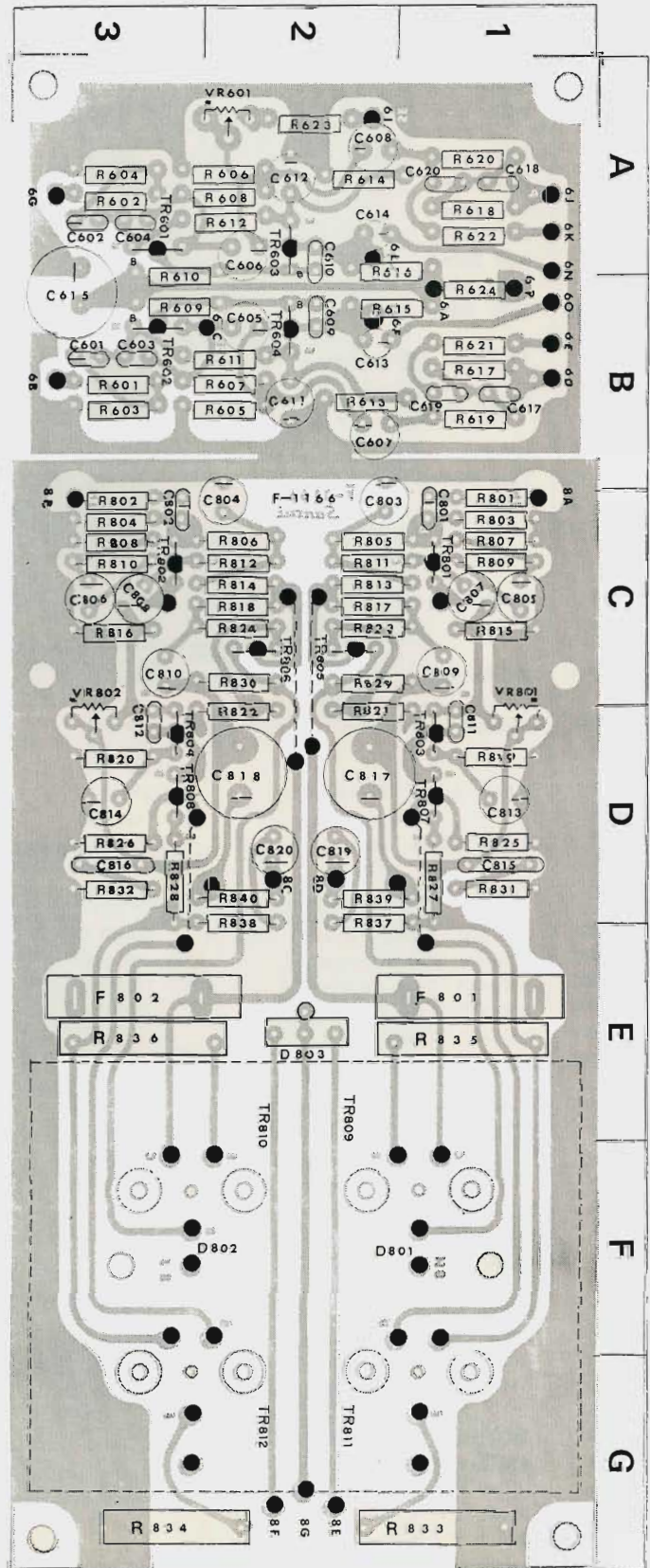

OTHER PARTS AND THEIR POSITION ON CHASSIS

X: Parts No Y: Parts Name

OTHER PARTS

X	Y	
D001	IN60	(031033)
PL001	6.3V 250mA	(040008)
PL002	6.3V 250mA	(040008)
PL003	6.3V 250mA	(040008)
PL004	6.3V 250mA	(040008)
PL005	6.3V 250mA	(040008)
PL006	5.0V 60mA Indicator Lamp	(040010-1)
PL007	6.0V 30mA Stereo Indicator	(040011)
F001	1A 250V Power Fuse	(043002)
M001	200 μ A Tuning Meter	(090020)
S1(a~f)	Selector Switch	(110324-1)
S2(a, b)	Tape Monitor Switch	(117006)
S3(a, b)	Mode Switch	(117006)
S4(a, b)	Loudness Switch	(117006)
S5	Power Switch	
J001	Headphone Jack	(243006)
J002	DIN Jack	(243004)
CO001	AC Outlet	(2450011)
PU002	Voltage Selector Plug	(241017) (241018) (241019)
L001	3.5 μ H \pm 10% Peaking Coil	(429001-1)
L002	Bar Antenna	(420025)
L003	3.5 μ H \pm 10% Peaking Coil	(429001-1)
T001	Power Transformer	(400049)
VR001	100k Ω Ⓐ Volume Adjustor	(102005)
VR002	100k Ω Ⓐ Volume Adjustor	(102005)
VR003	100k Ω Ⓒ Tone Control	(101039)
VR004	100k Ω Ⓒ Tone Control	(101039)
VR005	100k Ω Ⓒ Tone Control	(101039)
VR006	100k Ω Ⓒ Tone Control	(101039)
R001	22k Ω \pm 10% $\frac{1}{4}$ W Carbon Resistor	
R002	22k Ω \pm 10% $\frac{1}{4}$ W Carbon Resistor	
R003	100k Ω \pm 10% $\frac{1}{4}$ W Carbon Resistor	
R004	100k Ω \pm 10% $\frac{1}{4}$ W Carbon Resistor	
R005	330k Ω \pm 10% $\frac{1}{4}$ W Carbon Resistor	
R006	330k Ω \pm 10% $\frac{1}{4}$ W Carbon Resistor	
R007	100k Ω \pm 10% $\frac{1}{4}$ W Carbon Resistor	
R008	100k Ω \pm 10% $\frac{1}{4}$ W Carbon Resistor	
R009	8.2k Ω \pm 10% $\frac{1}{4}$ W Carbon Resistor	
R010	8.2k Ω \pm 10% $\frac{1}{4}$ W Carbon Resistor	
R011	10k Ω \pm 10% $\frac{1}{4}$ W Carbon Resistor	
R012	10k Ω \pm 10% $\frac{1}{4}$ W Carbon Resistor	
R013		
R014	220 Ω \pm 10% $\frac{1}{4}$ W Carbon Resistor	
R015	680 Ω \pm 10% $\frac{1}{2}$ W Solid Resistor	
R016		
R017	220 Ω \pm 10% $\frac{1}{2}$ W Solid Resistor	
R018	220 Ω \pm 10% $\frac{1}{2}$ W Solid Resistor	

X	Y	
R019	100 Ω \pm 10% $\frac{1}{2}$ W Solid Resistor	
R020	100 Ω \pm 10% $\frac{1}{2}$ W Solid Resistor	
R021	2.2k Ω \pm 10% $\frac{1}{4}$ W Carbon Resistor	
R022	2.2k Ω \pm 10% $\frac{1}{4}$ W Carbon Resistor	
C001	470 pF \pm 10% 50 WV Mica Capacitor	
C002	470 pF \pm 10% 50 WV Mica Capacitor	
C003	0.047 μ F \pm 10% 50 WV Mylar Capacitor	
C004	0.047 μ F \pm 10% 50 WV Mylar Capacitor	
C006	0.02 μ F $\frac{+100}{-0}$ % 25 WV Ceramic Capacitor	
C007	0.02 μ F $\frac{+100}{-0}$ % 25 WV Ceramic Capacitor	
C008	0.02 μ F $\frac{+100}{-0}$ % 25 WV Ceramic Capacitor	
C009	1000 μ F $\frac{+100}{-0}$ % 35 WV Electrolytic Capacitor (020528-1)	
C010	1000 μ F $\frac{+100}{-0}$ % 35 WV Electrolytic Capacitor (020528-1)	
C011	0.0047 μ F \pm 10% 600WV Oil Capacitor	
C013	0.0047 μ F \pm 10% 600WV Oil Capacitor	
C014	100 pF \pm 10% 50 WV Ceramic Capacitor	
C015	100 pF \pm 10% 50 WV Ceramic Capacitor	

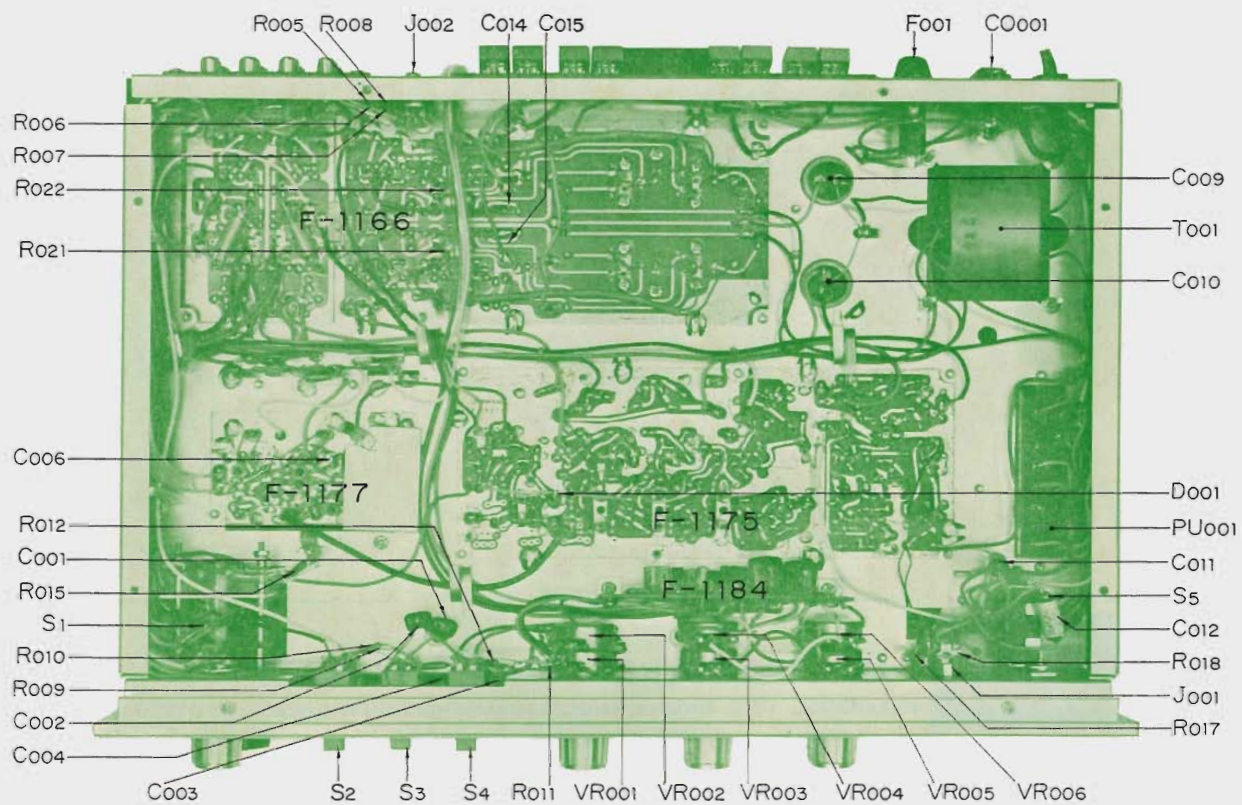
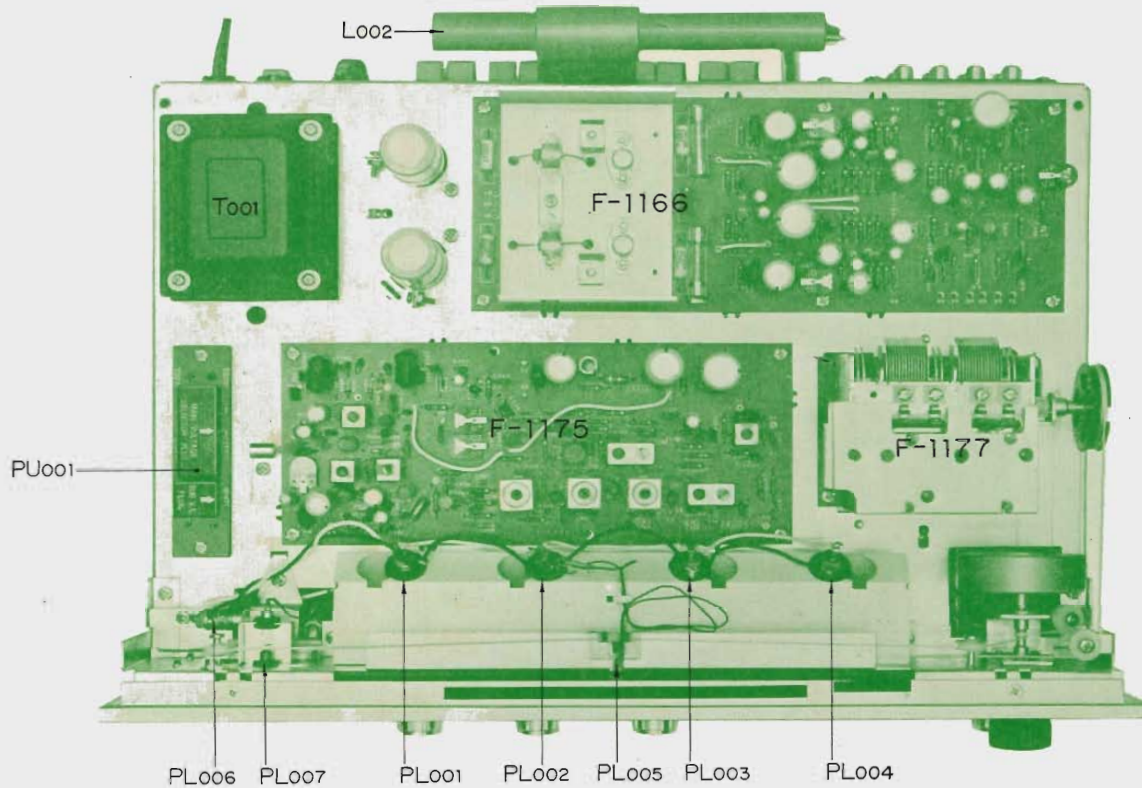



SANSUI ELECTRIC COMPANY LIMITED

Head Office; 14-1, 2-chome, Izumi, Suginami-ku, Tokyo, Japan. TEL. 323-1111

Printed in Japan (20040M4)

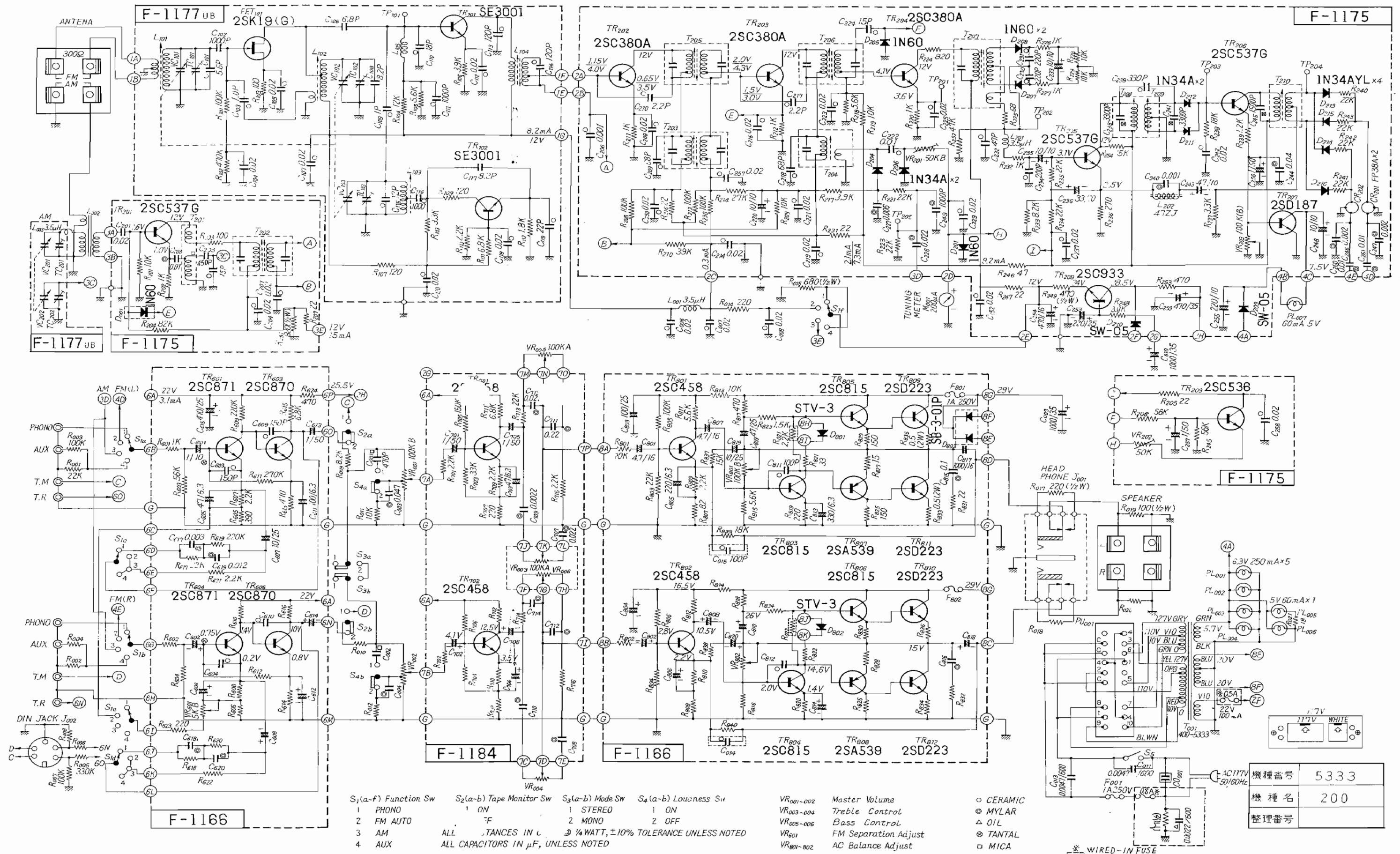

$S_1(a-f)$ Function Sw
 1 PHONO
 2 FM AUTO
 3 AM
 4 AUX

$S_2(a-b)$ Tape Monitor Sw
 1 ON
 2 OFF

$S_3(a-b)$ Mode Sw
 1 STEREO
 2 MONO

$S_4(a-b)$ Loudness Sw
 1 ON
 2 OFF

ALL CAPACITANCES IN μ F, UNLESS NOTED
 ALL RESISTANCES IN Ω , $\frac{1}{4}$ WATT, $\pm 10\%$ TOLERANCE UNLESS NOTED

VR₀₀₁₋₀₀₂ Master Volume
 VR₀₀₃₋₀₀₄ Treble Control
 VR₀₀₅₋₀₀₆ Bass Control
 VR₆₀₁ FM Separation Adjust
 VR₈₀₁₋₈₀₂ AC Balance Adjust

○ CERAMIC
 ⊗ MYLAR
 △ OIL
 ⊕ TANTALUM
 □ MICA
 ■ POLYSTYROL
 * WIRED-IN FUSE
 [] CSA APPROVED EQUIPMENT ONLY

機種番号	5333
機種名	200
整理番号	