

OPERATING INSTRUCTIONS & SERVICE MANUAL

SOLID-STATE AM/FM STEREO TUNER AMPLIFIER

SANSUI 210

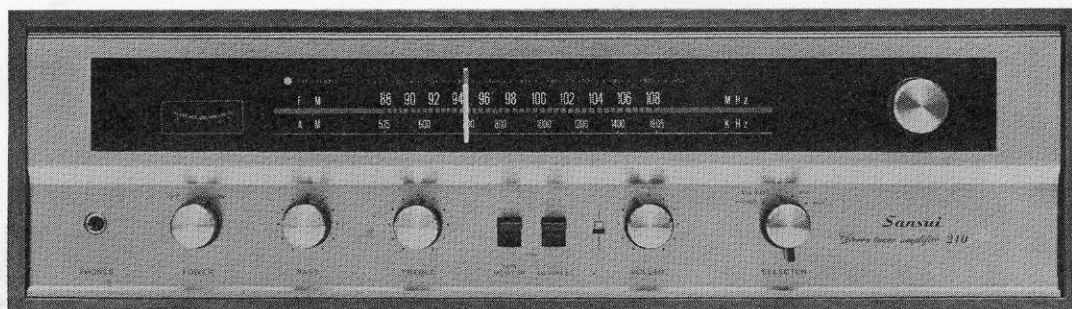

Sansui

SANSUI ELECTRIC CO., LTD.

Congratulations! In selecting the Sansui 210 AM/FM stereo tuner amplifier, you have made an excellent choice, one that promises you years of rich stereo sound enjoyment. As the world's foremost audio-only specialist, Sansui has spared no effort in making the 210 the most versatile and most sophisticated receiver in its price range. The highly sensitive FET front end, all silicon transistor circuitry with low noise and low distortion, and sufficient front-panel control facilities have all been engineered into the 210.

This manual and the accompanying sheet have been prepared to guide you in installing and operating the receiver correctly. They contain some very helpful information on making connections, using controls properly and operating components most effectively. Please read them carefully before operating the receiver and retain them for future reference.

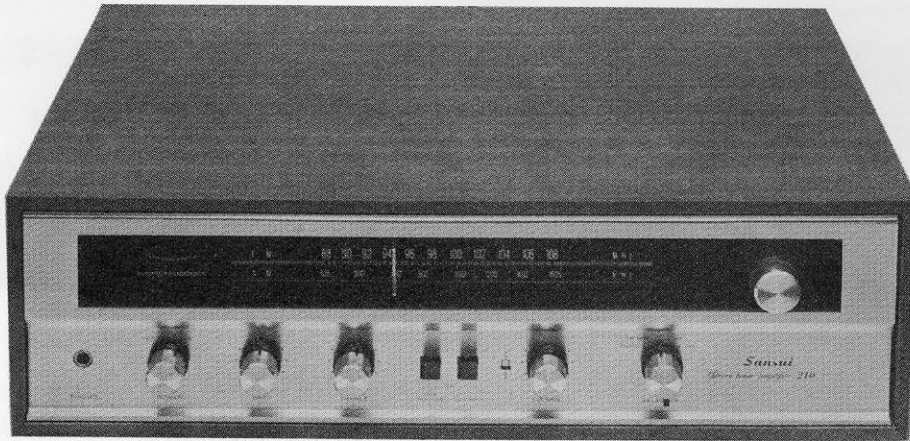

CONTENTS

OPERATIONS/CONNECTIONS.....	2, 3
MAINTENANCE	4
DISASSEMBLY PROCEDURE	5
SPECIFICATIONS/ACCESSORIES	6
SCHEMATIC DIAGRAM.....	7, 8
PRINTED CIRCUIT BOARDS	
AND PARTS LIST.....	9, 10, 11, 12, 13
OTHER PARTS AND THEIR POSITION ON CHASSIS.....	14

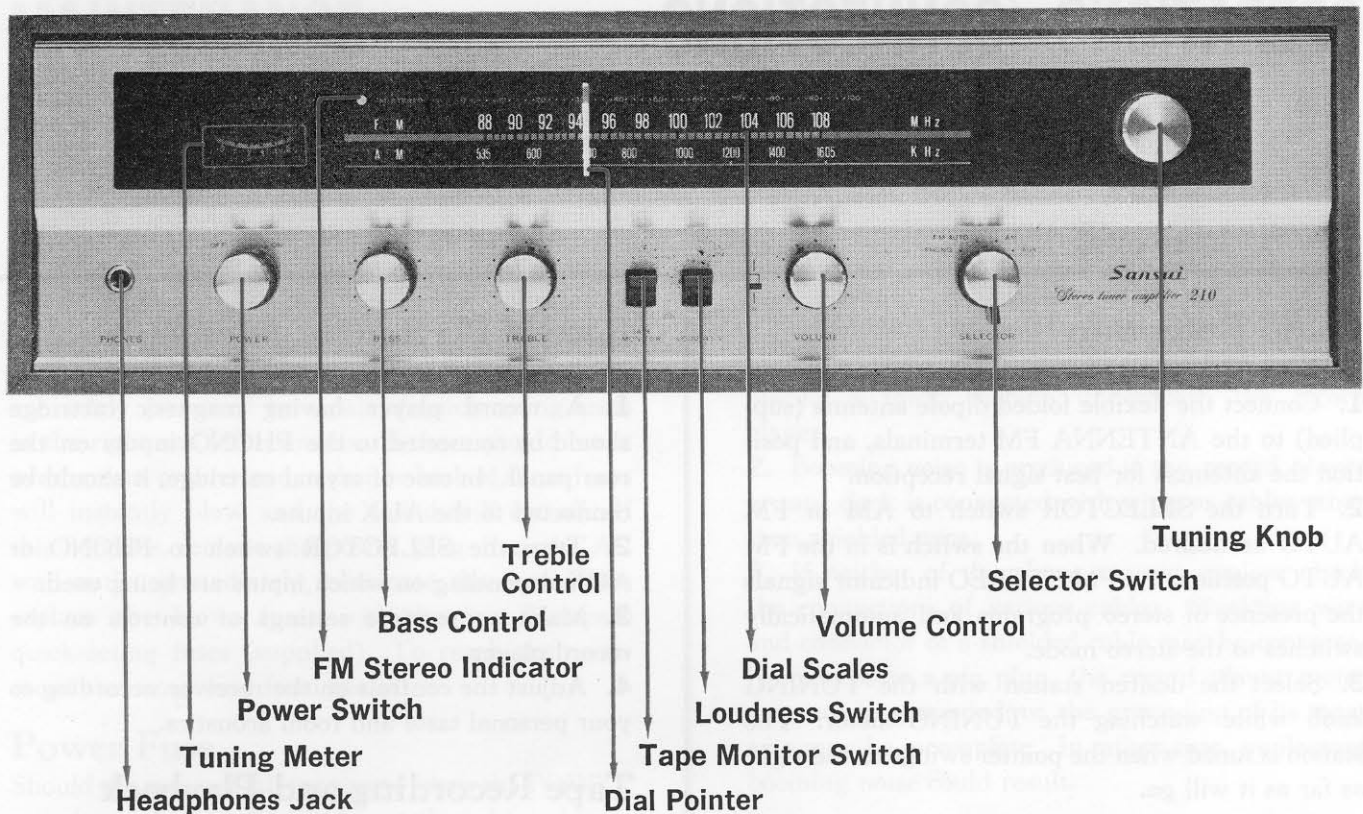

OPERATIONS/CONNECTIONS

How to connect other components to the 210 and how to use its front-panel controls and switches are explained on the accompanying sheet entitled Front Panel Information and Component Connections. Although the sheet may be used as a quick guide, we recommend that you read this manual before operating the 210 and get full knowledge of its capabilities.

Speaker Connections

To connect a pair of speakers to the 210, proceed as follows:

1. Connect the speaker on your right (as viewed from the listening area) to the RIGHT SPEAKER terminal marked + on the rear panel of the receiver.
2. Connect the lead from the common terminal of the right channel speaker to the RIGHT SPEAKER terminal marked -.
3. Connect the left channel speaker to the LEFT SPEAKER terminal marked +.
4. Connect the lead from the common terminal of the left channel speaker to the LEFT SPEAKER terminal marked -.

Caution: If you want to connect two or more speakers to one terminal in parallel, their combined impedance must be 4 ohms or more.

OPERATIONS/CONNECTIONS

Radio Reception

To listen to radio programs, proceed as follows:

1. Connect the flexible folded dipole antenna (supplied) to the ANTENNA FM terminals, and position the antennas for best signal reception.
2. Turn the SELECTOR switch to AM or FM AUTO as desired. When the switch is in the FM AUTO position, the FM STEREO indicator signals the presence of stereo programs and automatically switches to the stereo mode.
3. Select the desired station with the TUNING knob while watching the TUNING meter. The station is tuned when the pointer swings to the right as far as it will go.

Notes:

1. The FM dipole antenna should be opened to a full 'T' and positioned for maximum signal pick-up. The TUNING meter helps adjust it. In area remote from broadcast stations or inside ferroconcrete buildings where signal intensity is low, the indoor dipole antenna alone may not supply sufficient signal inputs. An outdoor antenna designed specifically for FM then becomes necessary. If one antenna is to be shared for both TV and FM receptions through the use of a splitter, make certain the TV reception is not affected. For reasons of safety, any outdoor antenna should be outfitted with a lightning arrester.
2. The PVC wire is used as an antenna for AM reception. When you cannot obtain the desired results by using the built-in AM ferrite bar antenna only, connect a PVC cord to the AM antenna terminal, extending it outdoors if possible.

Record Playing

To listen to records, proceed as follows:

1. A record player having magnetic cartridge should be connected to the PHONO inputs on the rear panel. In case of crystal cartridge, it should be connected to the AUX inputs.
2. Turn the SELECTOR switch to PHONO or AUX depending on which inputs are being used.
3. Make appropriate settings of controls on the record player.
4. Adjust the controls on the receiver according to your personal taste and room acoustics.

Tape Recording and Playback

Connect the recording inputs of a tape deck to the TAPE REC pin jacks on the rear panel of the 210 and then connect the playback outputs of the tape deck to the TAPE MON pin jacks on the receiver by using shielded cables.

If a tape deck has connecting cable fitted with 5-pin DIN connector, connect it to the TAPE REC socket on the rear panel. DIN socket is used for both recording and playback. But do not use TAPE REC/MON pin jacks and TAPE REC DIN socket simultaneously.

To record on the tape deck connected to the 210, proceed as follows:

1. Set the SELECTOR switch to the desired program source.
 2. Operate the tape deck in the recording mode.
- Note:** The controls and switches on the receiver control only the sound from the speakers. Tape monitoring is possible with a tape deck which has its own playback preamplifier as well as separate recording and playback heads. To monitor, turn the TAPE MONITOR switch on.

To playback through the 210, proceed as follows:

1. Turn on the TAPE MONITOR switch.
2. Operate the tape deck in the playback mode.
3. Adjust the controls on the receiver according to your personal taste and room acoustics.

MAINTENANCE

Should a Quick-acting Fuse Blow...

The expensive silicon power transistors on the 210 are safely protected by a pair of quick-acting fuses in the right and left channels. If there should occur overcurrent or overload, either or both of these fuses will instantly blow and the sound will cut off. If this happens, remove the power plug from its AC wall outlet immediately, eliminate the cause, then replace the blown fuses with the new 2-ampere quick-acting fuses (supplied). To reach them, remove the wood case from the set.

Power Fuse

Should the receiver fail to operate when the POWER switch is turned on, it may be attributed to a blown power fuse. To check, remove the line cord from its AC wall outlet and then the wood case. If it is blown, replace it with a new fuse of the same capacity 1-ampere fuse for 220-240 volt operation, 1.5-ampere fuse for 100-117 volt operation.

Caution: Never use the quick-acting and power fuses other than specified herein.

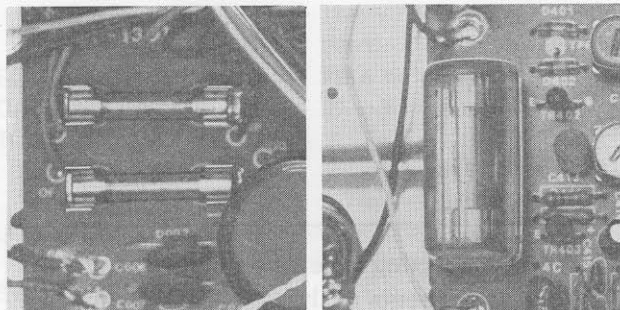

Quick-acting Fuses (2A)

Power Fuse

If Booming Noise is Heard When Playing a Record...

Unpleasant booming hum or howling noise may be heard when playing a record or a recorded tape. This is almost invariably due to one of these reasons:

1. If the record player is placed directly on a speaker enclosure or very close to it, the vibration of the speaker will be transmitted to the record player, resulting in a booming phenomenon called howling.

This can be easily corrected by separating the record player away from the speaker enclosure or placing a thick cushion underneath the record player.

2. Booming noise is produced if the record player or tape deck is connected with wires or cables other than shielded ones.

3. If neither of the above reasons applies, check the connections of various cables. Shielding wire and conductor of a shielded cable may be conversely soldered to a pin plug, the record player motor may not be grounded, or the grounding of its tone-arm may be incomplete. In either case, unpleasant booming noise could result.

Voltage Selector

The 210 is shipped with the voltage selector pre-adjusted at the factory to your area. If the receiver is to be operated from different voltage line, the voltage selector must be changed to the appropriate position required for your new area. To change, remove the metal stopper and then the plug, and insert the latter so that its arrow head points to 100V, 117V, 220V or 240V as required.

Caution: The receiver may be damaged if the voltage selector is set to the wrong position different from the line voltage in your area.

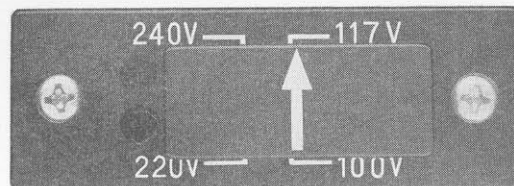

- For 100-117 voltage operation
 - a 1.5-ampere power fuse is required.
- For 220-240 voltage operation
 - a 1-ampere power fuse is required.

DISASSEMBLY PROCEDURE

MAINTENANCE

REMOVING THE FRONT PANEL, WOOD CASE AND BACK BOARD

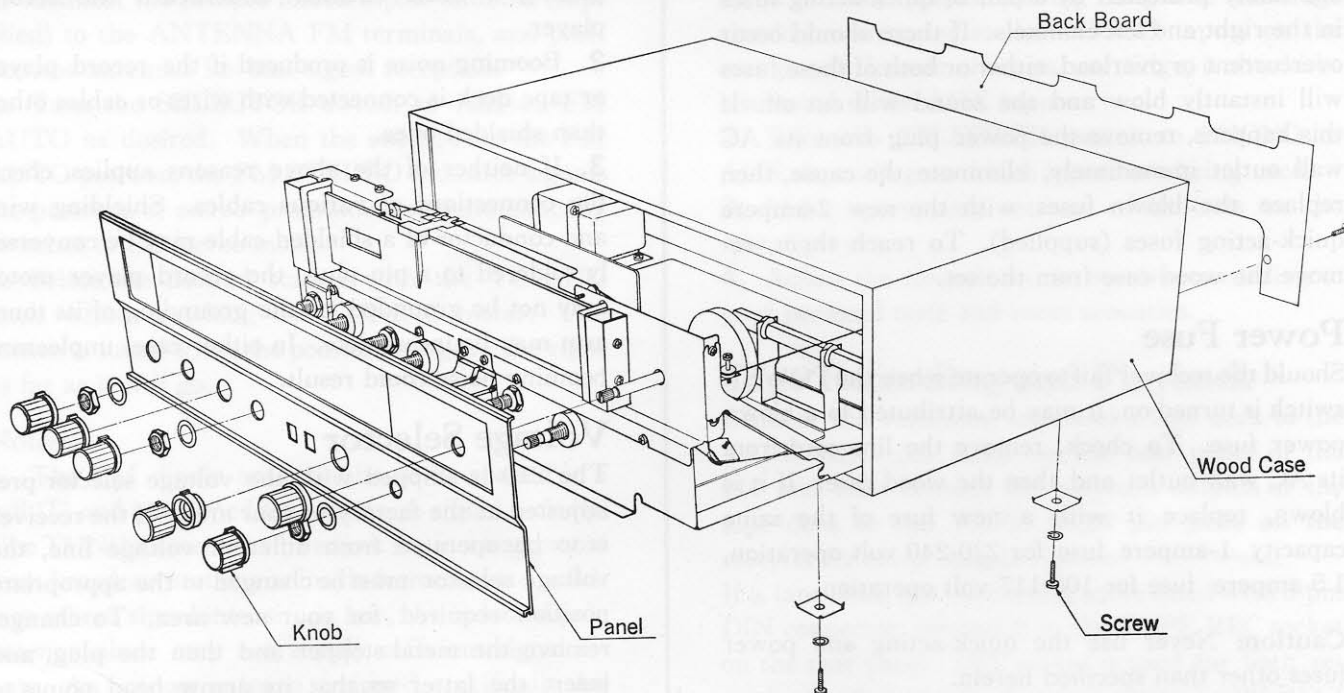

DIAL MECHANISM

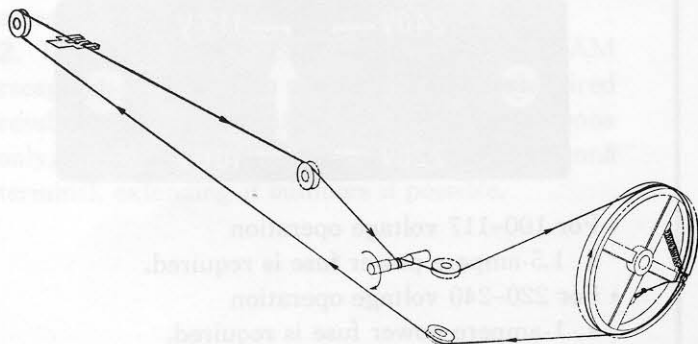

When connecting tape decks, record player or other components to the 210, be sure to use shielded wire. The shielded wire is made up for use as illustrated below:

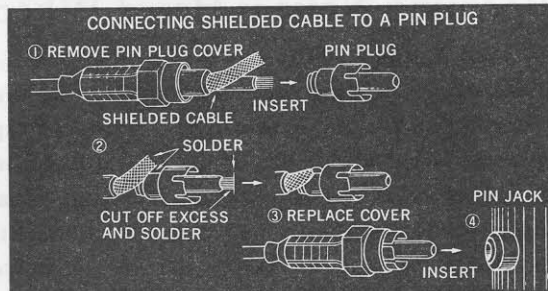

SPECIFICATIONS / ACCESSORIES

AUDIO SECTION

POWER OUTPUT (at rated distortion)	
CONTINUOUS RMS POWER OUTPUT:	10 Watts per channel \times 2 (both channels driven)
LOAD IMPEDANCE:	8 ohms
POWER BAND:	40 to 20,000Hz
TOTAL HARMONIC DISTORTION:	less than 1.0% (from AUX)
Music power (IHF):	34W (4 ohms 1,000Hz) 22W (8 ohms 1,000Hz)
Continuous rms power output:	10+10W (8 ohms 1,000Hz)
FREQUENCY RESPONSE	(at normal listening level)
AUX (over all):	25 to 30,000Hz \pm 2dB
CHANNEL SEPARATION	(at rated output, 1,000Hz)
PHONO:	better than 40dB
AUX:	better than 45dB
HUM AND NOISE (IHF)	
PHONO:	better than 65dB
AUX:	better than 70dB
INPUT SENSITIVITY	(at rated output, 1,000Hz)
PHONO:	3mV (50k ohms)
AUX:	180mV (50k ohms)
TAPE MON (pin):	180mV (30k ohms)
TAPE RECORDER (DIN):	180mV (30k ohms)
RECORDING OUTPUT	(at rated output, 1,000Hz)
TAPE REC (pin):	180mV
TAPE RECORDER (DIN):	30mV
EQUALIZER PHONO:	RIAA NF type
DAMPING FACTOR:	30 at 8 ohms load
TONE CONTROLS	
BASS:	+12dB -15dB at 50Hz
TREBLE:	+10dB -12dB at 10,000Hz
LOUDNESS CONTROL:	+8dB at 50Hz, +3dB at 10,000Hz (Volume Control at -30dB)
SWITCHES	
TAPE MONITOR:	ON, OFF
SELECTOR:	PHONO, FM AUTO, AM, AUX

TUNER SECTION

<FM>	
TUNING RANGE:	88 to 108MHz
SENSITIVITY (20dB quieting):	3 μ V
(IHF):	5.5 μ V
TOTAL HARMONIC DISTORTION:	less than 1%
SIGNAL TO NOISE RATIO:	better than 50dB
SELECTIVITY:	better than 35dB at 98MHz

IMAGE FREQUENCY REJECTION:

	better than 45dB at 98MHz
FM STEREO SEPARATION:	better than 30dB at 1,000Hz
SPURIOUS RADIATION:	less than 34dB
ANTENNA INPUT IMPEDANCE:	300 ohms balanced
<AM>	
TUNING RANGE	535 to 1,605kHz
SENSITIVITY	370 μ V (bar antenna)
IMAGE FREQUENCY REJECTION:	better than 50dB
SELECTIVITY:	better than 25dB
OTHER SPECIAL FEATURE:	Ferrite Bar Antenna

SEMICONDUCTORS:

Transistors; 30 FET; 1 Diodes; 20

POWER REQUIREMENTS

POWER VOLTAGE: 100, 117, 220, 240V 50/60Hz

POWER CONSUMPTION: 45W (max. signal)

DIMENSIONS: 435mm (17- $\frac{1}{8}$ ") W, 127mm (5") H,
282mm (11- $\frac{1}{8}$ ") D

WEIGHT: 6.1kg (13.5 lbs.)

Accessories

1. OPERATING INSTRUCTIONS & SERVICE MANUAL 1
2. OPERATING SHEET 1
3. FM ANTENNA 1
4. QUICKACTING FUSES (2A) 2

Operating Instructions Stock No. 9206120

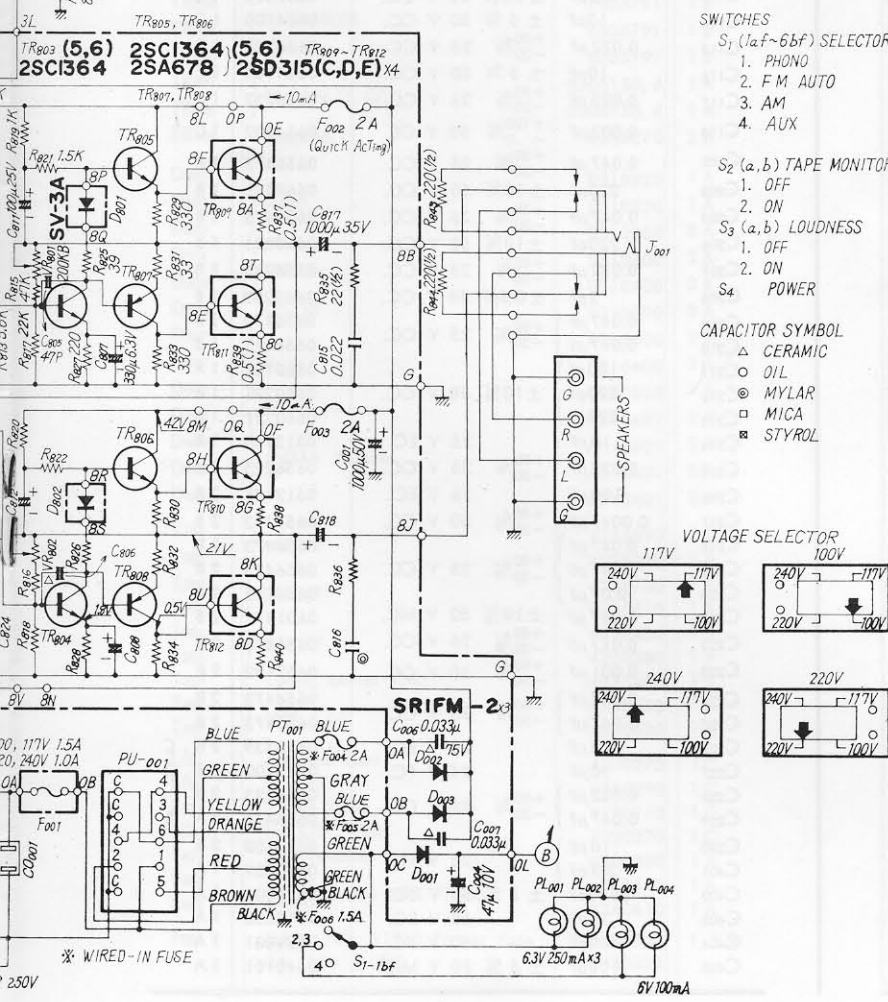
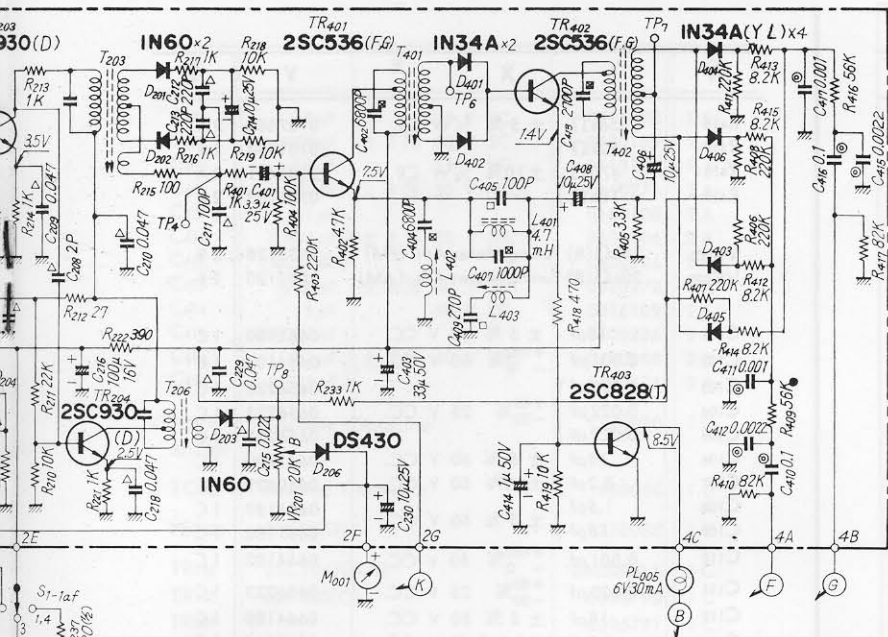

AM, FM, MPX BLOCK (F1304-S)

SWITCHES

- S₁ (1a-f-5b-f) SELECTOR
 1. PHONO
 2. F.M. AUTO
 3. AM
 4. AUX
- S₂ (a, b) TAPE MONITOR
 1. OFF
 2. ON
- S₃ (a, b) LOUDNESS
 1. OFF
 2. ON
- S₄ POWER

CAPACITOR SYMBOL

- △ CERAMIC
- OIL
- ⊙ MYLAR
- MICA
- ⊠ STYROL

VOLTAGE SELECTOR

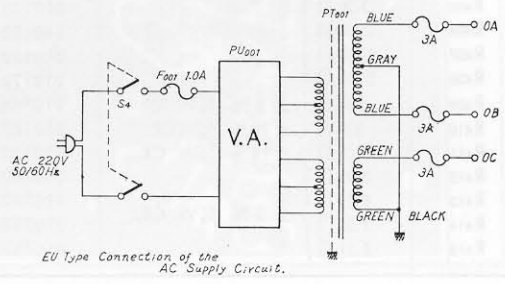
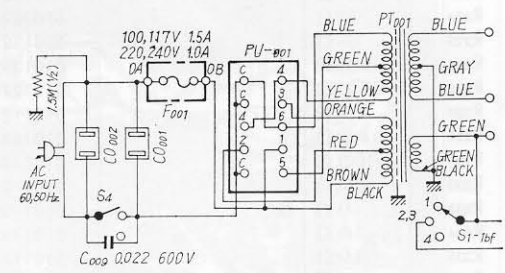
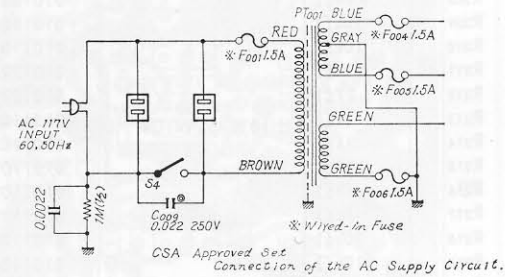
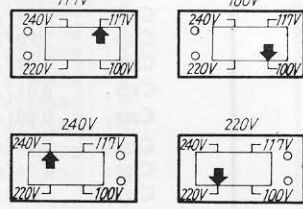

PRINTED CIRCUIT BOARDS AND PARTS LIST

W: Parts No. X: Parts Name Y: Stock No. Z: Position of Parts

AM, FM, MPX BLOCK <F-1304-2>

W	X	Y	Z	W	X	Y	Z
R101	100kΩ	0101104	1C	R416	56kΩ ± 5% 1/4W CR.	0107563	2A
R102	220kΩ	0100224	1C	R417	82kΩ	0101823	2A
R103	1MΩ	0101105	1C	R418	470Ω	0101471	2A
R104	100Ω	0101101	1C	R419	10kΩ	0101103	2A
R105	120Ω	0100121	1C	VR201	20kΩ(B) Tuning Meter Adj. (FM)	1032120	2B
R106	5.6kΩ	0101562	1C	VR202	20kΩ(B) Tuning Meter Adj. (AM)	1032120	2B
R107	12kΩ	0101123	1C	C101	15pF ± 5% 50 V CC.	0661150	1C
R108	3.9kΩ	0101392	1C	C102	0.001μF +100% 50 V CC.	0654102	1C
R109	5.6kΩ	0100562	1C	C103	0.022μF } +80% 25 V CC.	0656223	1C
R110	8.2kΩ	0100822	1C	C104	0.022μF } -20%	0656223	1C
R111	27Ω	0100270	1C	C105	0.022μF } ± 5% 50 V CC.	0661180	1C
R112	2.2kΩ	0101222	1C	C106	18pF ± 10% 50 V CC.	0660829	1C
R113	2.2kΩ	0100222	1C	C107	8.2pF ± 5% 50 V CC.	0661159	1C
R114	1kΩ	0101102	1C	C108	1.5pF } ± 5% 50 V CC.	0661180	1C
R201	560Ω	0101561	1C	C109	18pF } +100% 50 V CC.	0654102	1C
R202	4.7kΩ	0101472	1C	C110	0.001μF +80% 25 V CC.	0656223	1C
R203	1kΩ	0101102	1B	C111	0.022μF -20%	0664180	1C
R204	6.8kΩ	0101682	1B	C112	18pF ± 5% 50 V CC.	0669005	1C
R205	15kΩ	0101153	1B	C113	8.2pF ± 0.5pF 50 V CC.	0664100	1C
R206	680Ω	0101681	1B	C114	10pF ± 5% 50 V CC.	0656223	1C
R207	1kΩ	0101102	1B	C115	0.022μF +80% 25 V CC.	0664100	1C
R208	6.8kΩ	0101682	1B	C116	10pF ± 5% 50 V CC.	0656223	1C
R209	10kΩ	0101103	1B	C117	0.022μF +80% 25 V CC.	0654202	1C
R210	10kΩ	0101103	1B	C118	0.002μF +100% 50 V CC.	0656473	1B
R211	22kΩ	0101223	1B	C202	0.047μF +80% 25 V CC.	0660221	1B
R212	27Ω	0101270	1B	C203	220pF ± 10% 50 V CC.	0656473	1B
R213	1kΩ	0101102	1B	C205	0.047μF +80% 25 V CC.	0660221	1B
R214	1kΩ	0101102	1B	C206	220pF ± 10% 50 V CC.	0656223	1B
R215	100Ω	0101101	1A	C207	0.022μF +80% 25 V CC.	0660209	1B
R216	1kΩ	0101102	1A	C208	2pF ± 0.5pF 50 V CC.	0656473	1B
R217	1kΩ	0101102	1A	C209	0.047μF } +80% 25 V CC.	0656473	1B
R218	10kΩ	0101103	1A	C210	0.047μF } -20%	0660101	1A
R219	10kΩ	0101103	1A	C211	100pF } ± 10% 50 V CC.	0660221	1A
R221	1kΩ	0101102	2B	C212	220pF } ± 10% 50 V CC.	0660221	1A
R222	390Ω	0101391	2B	C213	220pF	0513100	1B
R223	220Ω	0101221	2B	C214	10μF 25 V EC.	0656223	2A
R224	27Ω	0101270	2B	C215	0.022μF +80% 25 V CC.	0512101	2B
R225	12kΩ	0101123	2B	C216	100μF 16 V EC.	0657472	2B
R226	3.9kΩ	0101392	2B	C217	0.0047μF +80% 50 V CC.	0656473	2B
R228	27Ω	0101270	2B	C218	0.047μF } +80% 25 V CC.	0656473	2B
R229	18kΩ	0101183	2B	C219	0.047μF } -20%	0656103	2B
R230	6.8kΩ	0101682	2B	C220	0.01μF	0601477	2B
R231	100kΩ	0101104	2B	C221	0.047μF ± 10% 50 V MC.	0656473	2B
R232	100kΩ	0101104	2B	C222	0.047μF +80% 25 V CC.	0657102	2B
R233	1kΩ	0101102	2A	C223	0.001μF +80% 50 V CC.	0656473	2B
R234	15kΩ	0101153	1B	C224	0.047μF } +80% 25 V CC.	0655473	2B
R235	15kΩ	0101153	1B	C225	0.047μF } -20%	0513339	2B, C
R401	1kΩ	0101102	1A	C226	3.3μF 25 V EC.	0513100	2B, C
R402	4.7kΩ	0101472	1A	C227	10μF 25 V EC.	0656223	2B
R403	220kΩ	0101224	1A	C228	0.022μF } +80% 25 V CC.	0656473	2A, B
R404	100kΩ	0101104	1A	C229	0.047μF } -20%	0513100	2B
R405	3.3kΩ	0101332	1A	C230	10μF } 25 V EC.	0513339	1A
R406	220kΩ	0101224	2A	C401	3.3μF } 25 V EC.	0629001	1A
R407	220kΩ	0101224	2A	C402	6800pF ± 5% 50 V SC.	0515330	1A
R408	220kΩ	0101224	2A	C403	33μF 50 V EC.	0629001	1A
R409	56kΩ ± 5% 1/4W CR.	0107563	2A	C404	6800pF 50 V SC.	0640101	1A
R410	82kΩ ± 10% 1/4W CR.	0101823	2A	C405	100pF ± 5% 50 V MiC.		
R411	220kΩ ± 10% 1/4W CR.	0101224	2A				
R412	8.2kΩ	0107822	2A				
R413	8.2kΩ	0107822	2A				
R414	8.2kΩ	0107822	2A				
R415	8.2kΩ ± 5% 1/4W CR.	0107822	2A				

Abbreviations

- | | | | |
|----|--------------------------|-----|----------------------------------|
| CR | : Carbon Resistor | MC | : Mylar Capacitor |
| SR | : Solid Resistor | SC | : Styrol Capacitor |
| WR | : Wire Wound Resistor | MIC | : Mica Capacitor |
| CC | : Ceramic Capacitor | OC | : Oil Capacitor |
| EC | : Electrolytic Capacitor | MPC | : Metallized Polyester Capacitor |

W	X	Y	Z
C406	10 μF 25 V EC.	0513100	1 A
C407	1000 pF ± 5 % 50 V SC.	0620102	1 A
C408	10 μF 25 V EC.	0513100	1, 2 A
C409	270 pF ± 5 % 50 V MIC.	0640271	2 A
C410	0.1 μF	0600108	2 A
C411	0.001 μF } ± 5 % 50 V MC.	0600106	2 A
C412	0.0022 μF }	0600226	2 A
C413	2700 pF ± 5 % 50 V SC.	0620272	1 A
C414	1 μF 50 V EC.	0515109	2 A
C415	0.0022 μF }	0600226	2 A
C416	0.1 μF } ± 5 % 50 V MC.	0600108	2 A
C417	0.001 μF }	0600106	2 A
VC101~103	Variable Capacitor	1220090	1 C
201, 202			
TC103	Padding Capacitor	1230050	1 C
FET101	3SK39(Q)	0370080	1 C
TR101	2SC1047(A,B)	0305800.1	1 C
TR102	2SC930(C)	0305790	1 C
TR201	} 2SC930(D)	0305791	1 C
TR202		0305791	1 B
TR203		0305791	1 B
TR204		0305791	1 B
TR401		0305155.6	1 A
TR402	} 2SC536 (F, G)	0305155.6	1 A
TR403	2SC828(T)	0305270	2 A
D201	} IN60	0310330	1 A
D202		0310330	1 A
D203		0310330	2 A
D204		} IN34A	0310400
D205	0310400		2 B
D206	DS430	0310090	2 A
D207		0310400	2 B
D401	} IN34A	0310400	1 A
D402		0310400	1 A
D403	} IN34A Yellow	0310401	2 A
D404		0310401	2 A
D405		0310401	2 A
D406		0310401	2 A
T101	} FM IFT	4235690	1 C
T201		4235720	1 B
T202		4235730	1 B
T203	4235710	1 B	
T204	} AM IFT	4230430	1 B
T205		4230380	1 B
T206	Tuning Meter Coil	4235400	1 B
T401	} MPX Coil	4240630	1 A
T402		4240620	1 A
L101	Antenna Coil	4200370	1 C
L102	RF Coil	4210090	1 C
L103	Choke Coil	4290110	1 C
L104	FM OSC Coil	4220270	1 C
L401	Ferri-inductor	4900300	1 A
L402	} FM MPX Filter	4240640	1 A
L403		67kHz	4240610
F001	1.5A (100, 117V) Power Fuse	0430122	1, 2 A
	1A (220, 240V)	0430022	

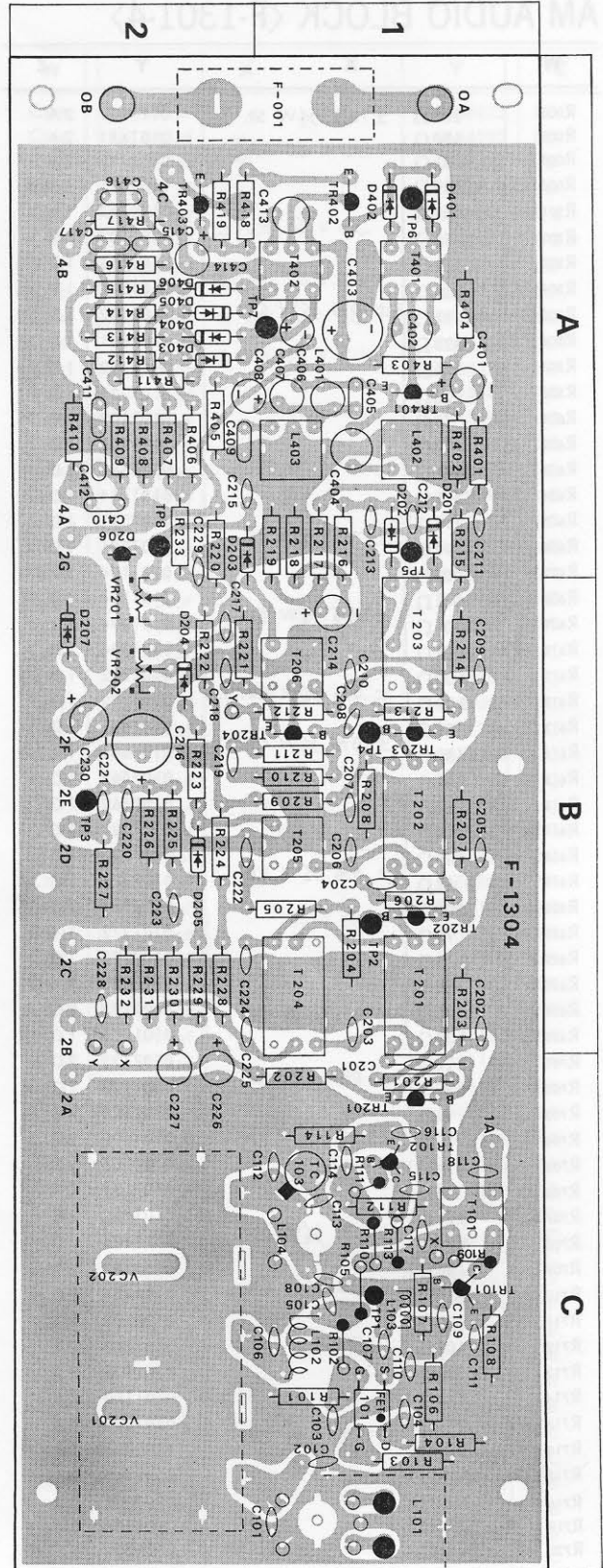

PRINTED CIRCUIT BOARDS AND PARTS LIST

AM AUDIO BLOCK <F-1301-4>

W	X	Y	Z
R001	220Ω ±10% ½W SR.	0111221	2 A
R002	680Ω	0101681	2 A
R003	1.2kΩ	0101122	2 A
R005	820Ω	0101821	1, 2 C
R301	15kΩ	0101153	1 D
R302	1kΩ	0101102	1 D
R303	15kΩ	0101153	1 D
R304	3.3kΩ	0101332	1 D
R305	1kΩ ±10% ¼W CR.	0101102	1 D
R306	820Ω	0101821	1 D
R307	1kΩ	0101102	1, 2 D
R308	220Ω	0101221	1 D
R601	1kΩ	0101102	1 D
R602	1kΩ	0101102	1 D
R603	560kΩ	0101564	1 D
R604	560kΩ	0101564	1 D
R605	390Ω	0107391	1 D
R606	390Ω ±5% ¼W CR.	0107391	1 D
R607	100kΩ	0101104	1 D
R608	100kΩ	0101104	1 D
R609	390kΩ ±10% ¼W CR.	0101394	1 D
R610	390kΩ	0101394	1 D
R611	2.2kΩ	0107222	1 D
R612	2.2kΩ ±5% ¼W CR.	0107222	1 D
R613	680Ω	0101681	1 D
R614	680Ω ±10% ¼W CR.	0101681	1 D
R615	5.6kΩ	0107562	1 D
R616	5.6kΩ	0107562	1 C
R617	22kΩ	0107223	1 C
R618	22kΩ	0107223	1 C
R619	330kΩ ±5% ¼W CR.	0107334	1 C
R620	330kΩ	0107334	1 C
R621	2.7kΩ	0107272	1, 2 C
R622	2.7kΩ	0107272	1 C
R623	12kΩ	0101123	1, 2 C
R624	12kΩ ±10% ¼W CR.	0101123	2 C
R625	100Ω	0101101	1 C
R701	12kΩ	0107123	2 C
R702	12kΩ ±5% ¼W CR.	0107123	2 C
R703	1kΩ	0101102	2 C
R704	1kΩ ±10% ¼W CR.	0101102	2 C
R705	1MΩ	0107105	2 C
R706	1MΩ ±5% ¼W CR.	0107105	2 C
R707	8.2kΩ	0101822	2 C
R708	8.2kΩ ±10% ¼W CR.	0101822	2 C
R709	680Ω	0107681	2 C
R710	680Ω ±5% ¼W CR.	0107681	2 C
R711	10kΩ	0101103	2 A
R712	10kΩ	0101103	2 A
R713	10kΩ	0101103	2 A
R714	10kΩ	0101103	2 A
R715	27kΩ	0101273	2 A
R716	27kΩ ±10% ¼W CR.	0101273	2 A
R717	2.2kΩ	0101222	2 A
R718	2.2kΩ	0101222	2 A
R719	330kΩ	0101334	2 C
R720	330kΩ	0101334	2 C

W	X	Y	Z
R801	4.7kΩ	0101472	2 B
R802	4.7kΩ	0101472	2 B
R803	180kΩ	0101184	2 B
R804	180kΩ	0101184	2 B
R805	100kΩ	0101104	2 B
R806	100kΩ ±10% ¼W CR.	0101104	2 B
R807	4.7kΩ	0101472	2 B
R808	4.7kΩ	0101472	2 B
R809	2.2kΩ	0101222	2 B
R810	2.2kΩ	0101222	2, 3 C
R811	82Ω	0107820	2 A
R812	82Ω	0107820	2 C
R813	5.6kΩ	0107562	1 B
R814	5.6kΩ ±5% ¼W CR.	0107562	1 B, C
R815	47kΩ	0107473	2 B
R816	47kΩ	0107473	2 B
R817	22kΩ	0101223	2 B
R818	22kΩ	0101223	2 C
R819	1kΩ	0101102	1 B
R820	1kΩ ±10% ¼W CR.	0101102	1 B
R821	1.5kΩ	0101152	1 B
R822	1.5kΩ	0101152	1 B
R825	39Ω	0107390	1, 2 C
R826	39Ω ±5% ¼W CR.	0107390	1 B
R827	220Ω	0101221	2 B
R828	220Ω	0101221	2 C
R829	330Ω	0101331	1 B
R830	330Ω	0101331	1, 2 B
R831	33Ω	0107330	1, 2 B
R832	33Ω ±5% ¼W CR.	0107330	1 B
R833	330Ω	0101331	2 B
R834	330Ω ±10% ¼W CR.	0101331	1 C
R835	22Ω	0111220	1 B
R836	22Ω ±10% ½W SR.	0111220	1 B
R837	0.5Ω	0141508	1 A
R838	0.5Ω	0141508	1 B
R839	0.5Ω ±10% 1W WR.	0141508	1 A
R840	0.5Ω	0141508	1 A, B
R841	22kΩ ±10% ¼W CR.	0101223	2 B
VR601	5kΩ (B) FM Separation Adj.	1032092	1 C
VR701, 702	100kΩ (B) × 2 VOLUME	1020081	2 C
VR703, 704	100kΩ (A) × 2 BASS	1010600	2 A
VR705, 706	100kΩ (A) × 2 TREBLE	1010600	2 A
VR801	200kΩ (B) AC Balance (Left)	1032152	1, 2 B
VR802	200kΩ (B) AC Balance (Right)	1032152	2 B
C001	1000μF } 50 V EC.	0549104	1 A, B
C002	220μF }	0515221	2 A
C003	100μF } 25 V EC.	0513101	2 A
C004	47μF } 10 V EC.	0511470	2 A
C005	0.022μF ±80% -20% } 25 V CC.	0656223	2 A
C006	0.033μF ±100% } 75 V CC.	0651333	1 A
C007	0.033μF - 0% } 75 V CC.	0651333	1 A
C008	330μF } 25 V EC.	0513331	1, 2 C

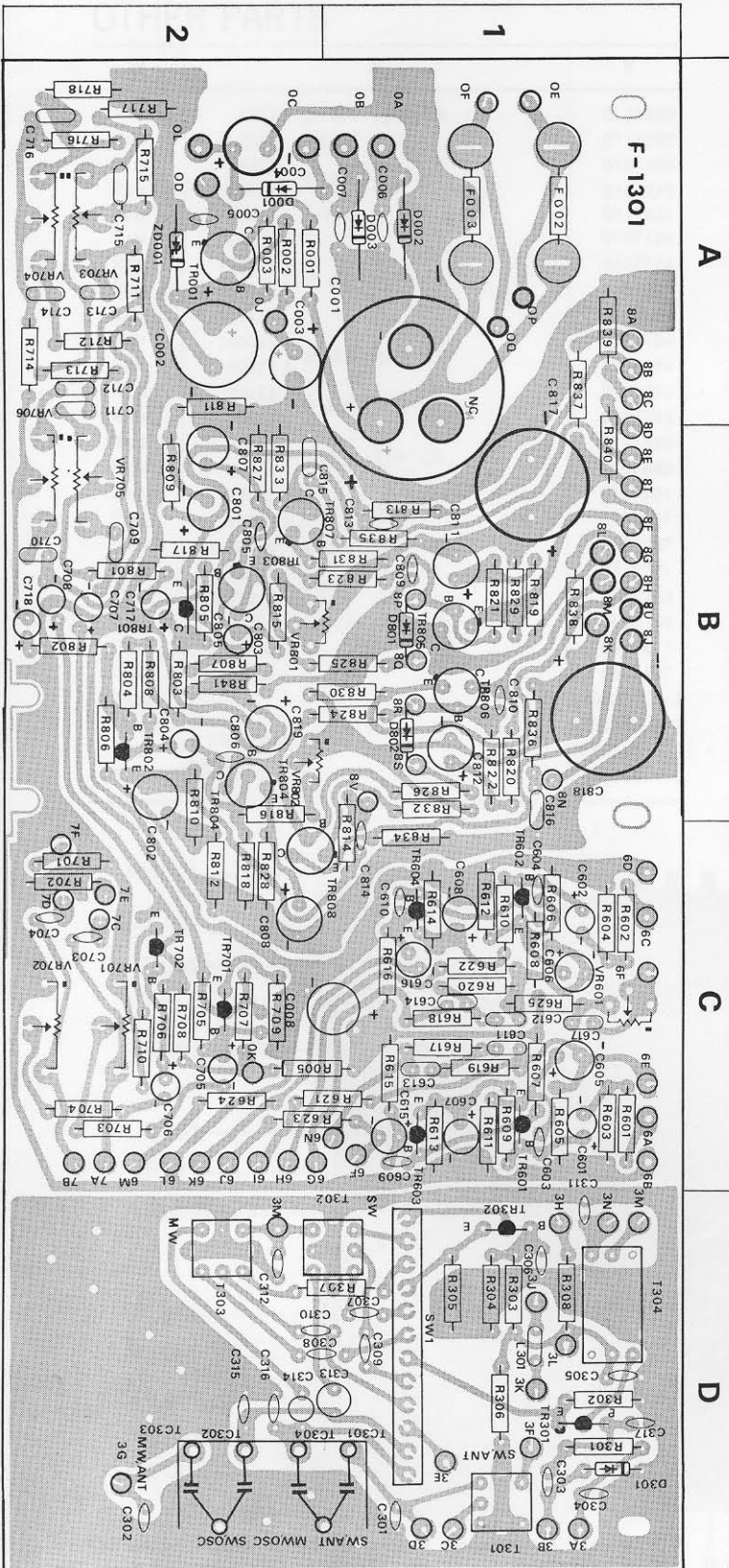

PRINTED CIRCUIT BOARDS AND PARTS LIST

W: Parts No. X: Parts Name Y: Stock No. Z: Position of Parts

W	X	Y	Z
C815	0.022 μ F } $\pm 10\%$ 50 V MC.	0601227	2 B
C816		0601227	1 B, C
C817	1000 μ F } 35 V EC.	0549004	1 B
C818		0549004	1 B
C819	100 μ F } 25 V EC.	0513101	2 B
C820	100 pF } 50 V CC.	0660101	
C821		0660101	
C823	4.7 μ F } 50 V EC.	0515479	
C824		0515479	
TR001	2SC971 Yellow (2)	0305530	1 D
TR301	2SC930 (C, D)	0305790, 1	2 A
TR302		0305790, 1	1 D
TR601	2SC1312R (G)	0306091	1 D
TR602		0306091	1 C
TR603	2SC1312R (G, H)	0306091, 2	1 C
TR604		0306091, 2	1 C
TR701		0306091, 2	2 C
TR702		0306091, 2	2 C
TR801	2SC693 (F)	0305171	2 B
TR802		0305171	2 B
TR803	2SC933 (E, F)	0305611, 2	2 B
TR804		0305611, 2	2 B
TR805	2SC1364 (5, 6) } Pair	0306130, 1	1 B
TR806		0306130, 1	1 B
TR807	2SA678 (5, 6) }	0300290, 1	2 B
TR808		0300290, 1	1, 2 C
ZD001	ZBI25	0315080	2 A
D001	SRIFM-2	0310870	2 A
D002		0310870	1 A
D003		0310870	1 A
D301		IN60	0310330
T303	AM OSC Coil	4220280	2 D
T304	AM IFT	4230430	1 D
L301	Ferri-inductor	4900130	1 D
S1	SELECTOR Switch	1103341	1 D
F002	2A Quick Acting Fuse	0433230	1 A
F003		0433230	1 A

* Design and specifications subject to change without notice for improvements.

OTHER PARTS AND THEIR POSITION ON CHASSIS

W: Parts No. X: Parts Name Y: Stock No.

OTHER PARTS

W	X	Y
R006	68Ω ±10% ¼W CR.	0101680
R115	2.2kΩ ±10% ½W SR.	0111222
R116	33Ω } ±10% ¼W CR.	0101330
R236	27kΩ } ±10% ¼W CR.	0101273
R237	820Ω ±10% SR.	0111821
R626	120kΩ } ±5% ¼W CR.	0107124
R627	120kΩ } ±5% ¼W CR.	0107124
R628	220kΩ } ±5% ¼W CR.	0107224
R629	220kΩ } ±5% ¼W CR.	0107224
R631	100kΩ } ±10% ¼W CR.	0101104
R632	100kΩ } ±10% ¼W CR.	0101104
R633	22kΩ } ±5% ¼W CR.	0107223
R634	22kΩ } ±5% ¼W CR.	0107223
R635	68kΩ } ±10% ¼W CR.	0101683
R636	68kΩ } ±10% ¼W CR.	0101683
R843	220Ω } ±10% ½W SR.	0111221
R844	220Ω } ±10% ½W SR.	0111221
C009	0.022μF ±20% 250V MPC.	0605227
C119	220μF 16V EC.	0512221
C120	0.022μF +80% -20% 50V CC.	0657223
C318	15pF ±10% 50V CC.	0660150
C701	0.047μF } ±10% 50V MC.	0601477
C702	0.047μF } ±10% 50V MC.	0601477
TR809	} 2SD315 (C, D, E)	0308330, 1, 2
TR810		0308330, 1, 2
TR811		0308330, 1, 2
TR812		0308330, 1, 2

W	X	Y
D801	} SV-3A	0340070
D802		0340070
T305	270μH Bar Antenna	4200410
PT001	Power Transformer	4000891
F004	} 2A Wired in Fuse	0432850
F005		0432850
F006		0432850
L302	Peaking Coil	4290140
M001	Tuning Meter	4300650
S2	TAPE MONITOR Switch	1170060
S3	LOUDNESS Switch	1170060
S4	POWER Switch	1190010
PL001	} 6.3V 250mA Dial Indicator Lamp	0420030
PL002		0420030
PL003	6.3V 250mA Turning Meter Indicator Lamp	0420030
PL004	6V 100mA Needle Indicator Lamp	0400160
PL005	6V 30mA FM Stereo Indicator Lamp	0400110
PU001	Volt Selector	2410080
CO001	} AC Outlets	2450040
CO002		2450040
J001	Headphones Jack	2430060
J002	DIN Jack	2430040

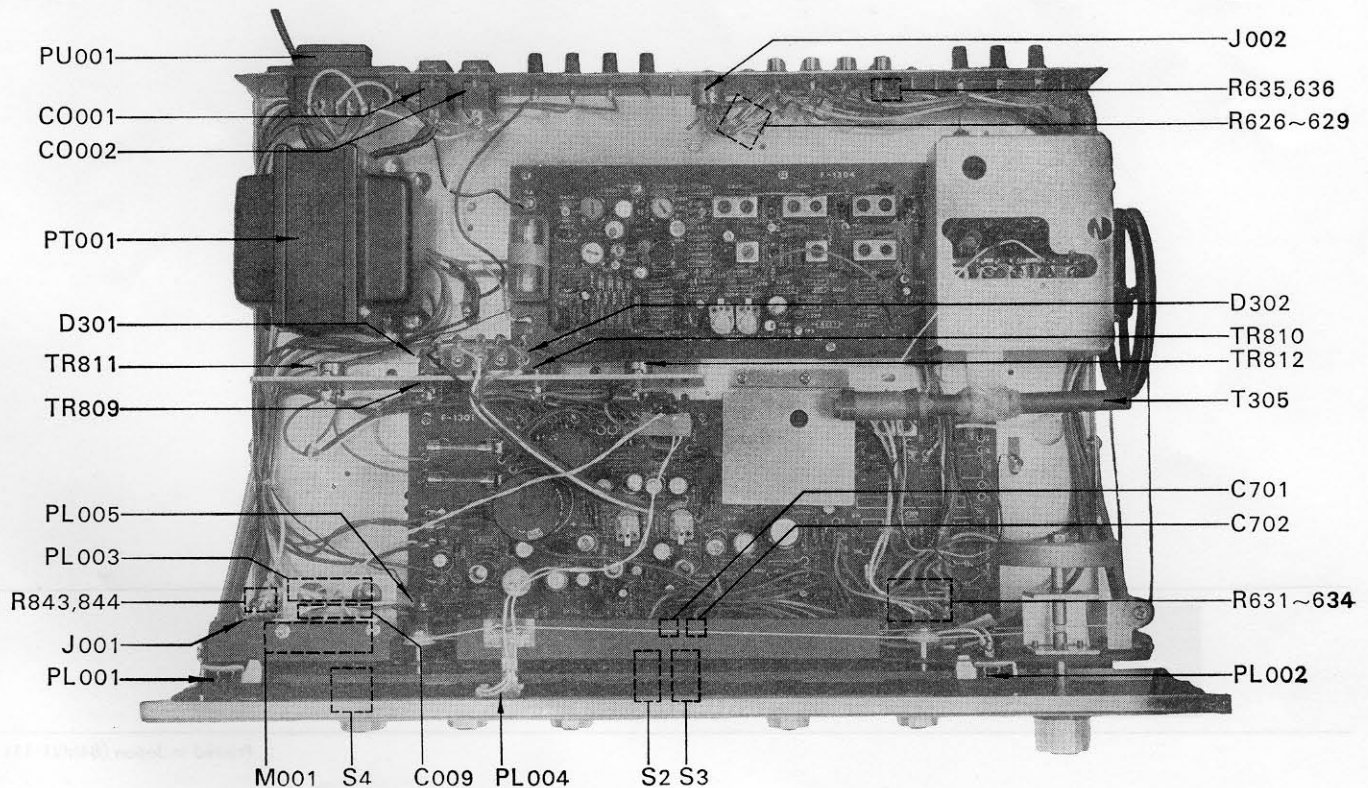

OTHER PARTS AND THEIR POSITION ON CHASSIS

W1 Parts No. X1 Parts Name Y1 Stock No.

OTHER PARTS

W	X	Y	W	X	Y
000010	000010	000010	000010	000010	000010
000020	000020	000020	000020	000020	000020
000030	000030	000030	000030	000030	000030
000040	000040	000040	000040	000040	000040
000050	000050	000050	000050	000050	000050
000060	000060	000060	000060	000060	000060
000070	000070	000070	000070	000070	000070
000080	000080	000080	000080	000080	000080
000090	000090	000090	000090	000090	000090
000100	000100	000100	000100	000100	000100
000110	000110	000110	000110	000110	000110
000120	000120	000120	000120	000120	000120
000130	000130	000130	000130	000130	000130
000140	000140	000140	000140	000140	000140
000150	000150	000150	000150	000150	000150
000160	000160	000160	000160	000160	000160
000170	000170	000170	000170	000170	000170
000180	000180	000180	000180	000180	000180
000190	000190	000190	000190	000190	000190
000200	000200	000200	000200	000200	000200
000210	000210	000210	000210	000210	000210
000220	000220	000220	000220	000220	000220
000230	000230	000230	000230	000230	000230
000240	000240	000240	000240	000240	000240
000250	000250	000250	000250	000250	000250
000260	000260	000260	000260	000260	000260
000270	000270	000270	000270	000270	000270
000280	000280	000280	000280	000280	000280
000290	000290	000290	000290	000290	000290
000300	000300	000300	000300	000300	000300
000310	000310	000310	000310	000310	000310
000320	000320	000320	000320	000320	000320
000330	000330	000330	000330	000330	000330
000340	000340	000340	000340	000340	000340
000350	000350	000350	000350	000350	000350
000360	000360	000360	000360	000360	000360
000370	000370	000370	000370	000370	000370
000380	000380	000380	000380	000380	000380
000390	000390	000390	000390	000390	000390
000400	000400	000400	000400	000400	000400
000410	000410	000410	000410	000410	000410
000420	000420	000420	000420	000420	000420
000430	000430	000430	000430	000430	000430
000440	000440	000440	000440	000440	000440
000450	000450	000450	000450	000450	000450
000460	000460	000460	000460	000460	000460
000470	000470	000470	000470	000470	000470
000480	000480	000480	000480	000480	000480
000490	000490	000490	000490	000490	000490
000500	000500	000500	000500	000500	000500



SANSUI ELECTRIC CO., LTD.
 14-1, 2-chome, Izumi, Suginamiku, Tokyo 168, Japan.
 TELEPHONE: (03) 323-1111 / TELEX: 232-2076