

SANSUI 7070 SCHEMATIC DIAGRAM

Sansui

SANSUI ELECTRIC CO., LTD.

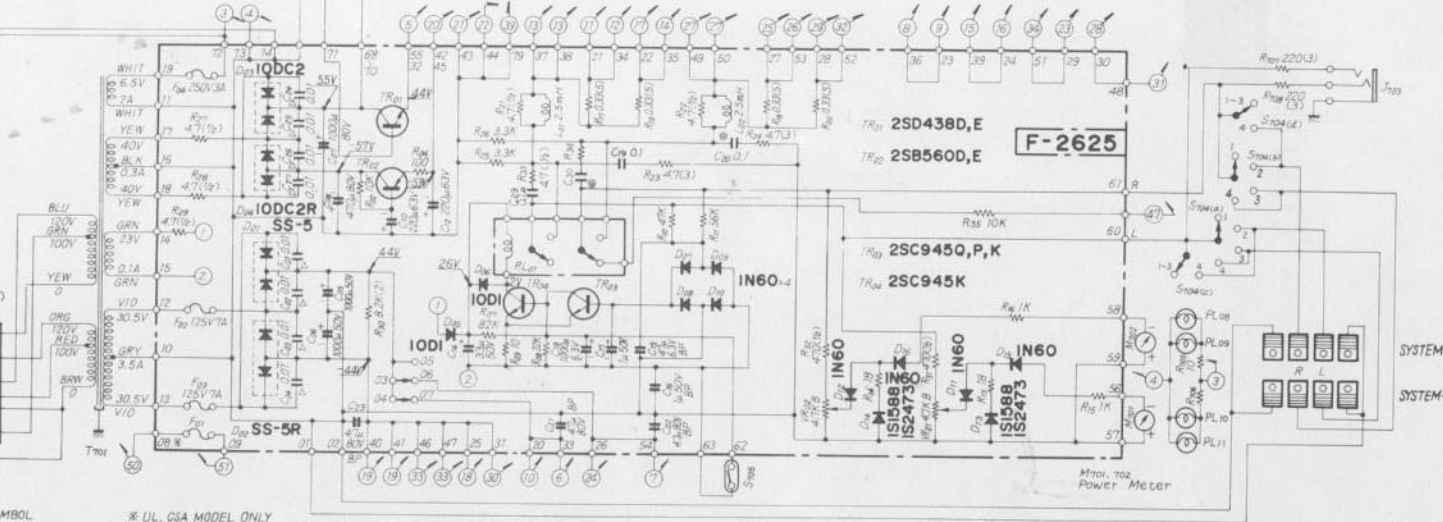
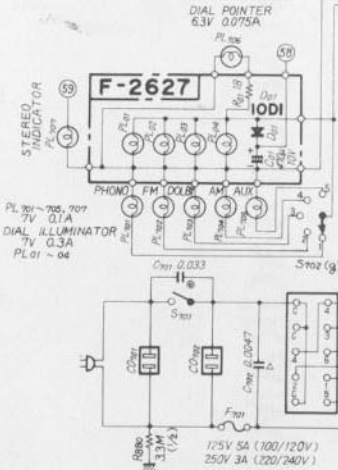
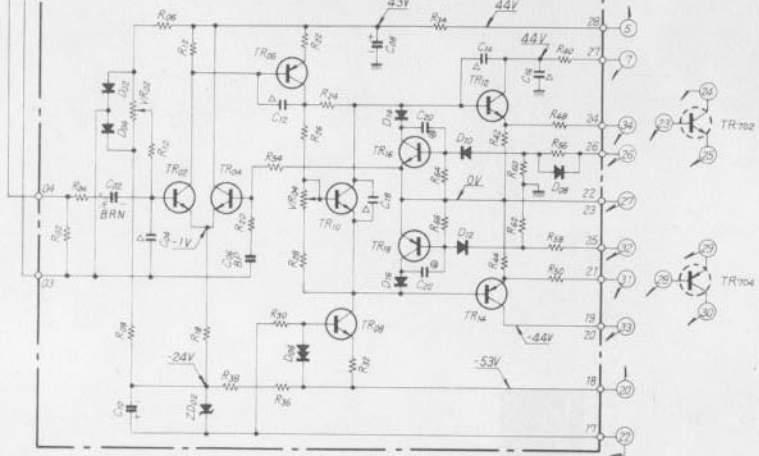
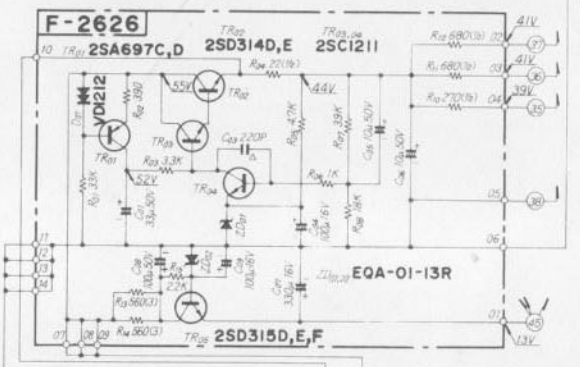
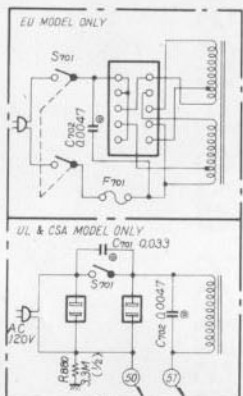
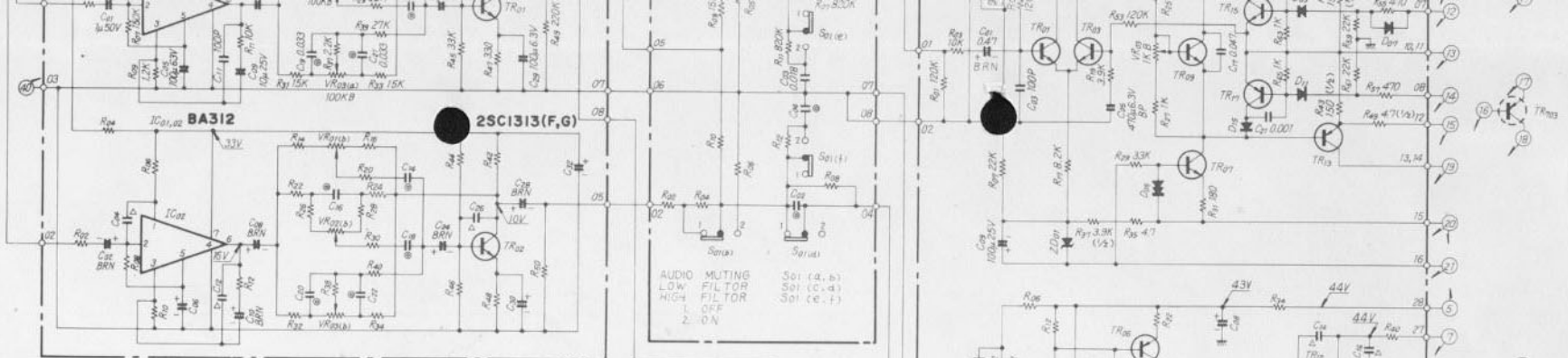

Note: CAPACITANCE SYMBOL
 ● CERAMIC
 ○ MYLER
 ○ STYROL
 ○ TANTALUM

* UL, CSA MODEL ONLY
 For 125V 5A

PL 08-11
 5V 0.06A

• La présentation et les spécifications sont susceptibles d'être modifiées sans préavis par suites d'améliorations éventuelles.
 • Änderungen, die dem technischen Fortschritt dienen, bleiben vorbehalten.
 • Design and specifications subject to change without notice for improvement.

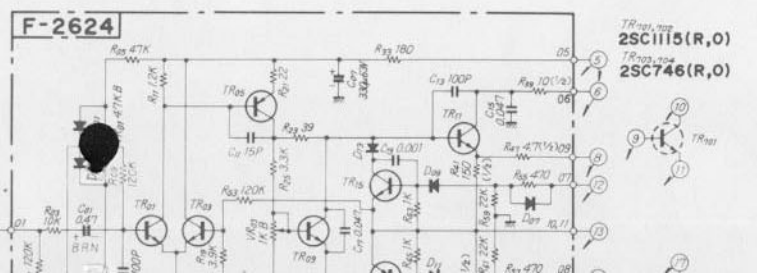
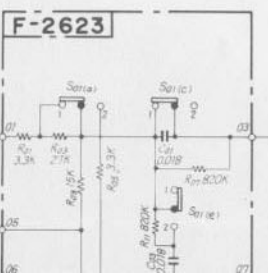
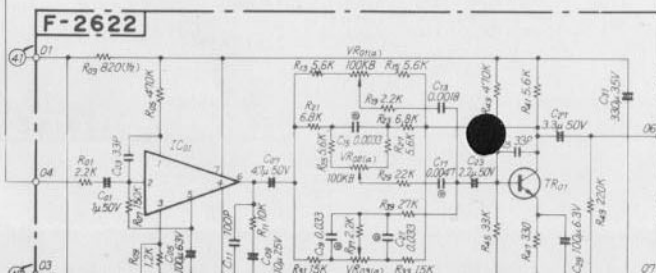
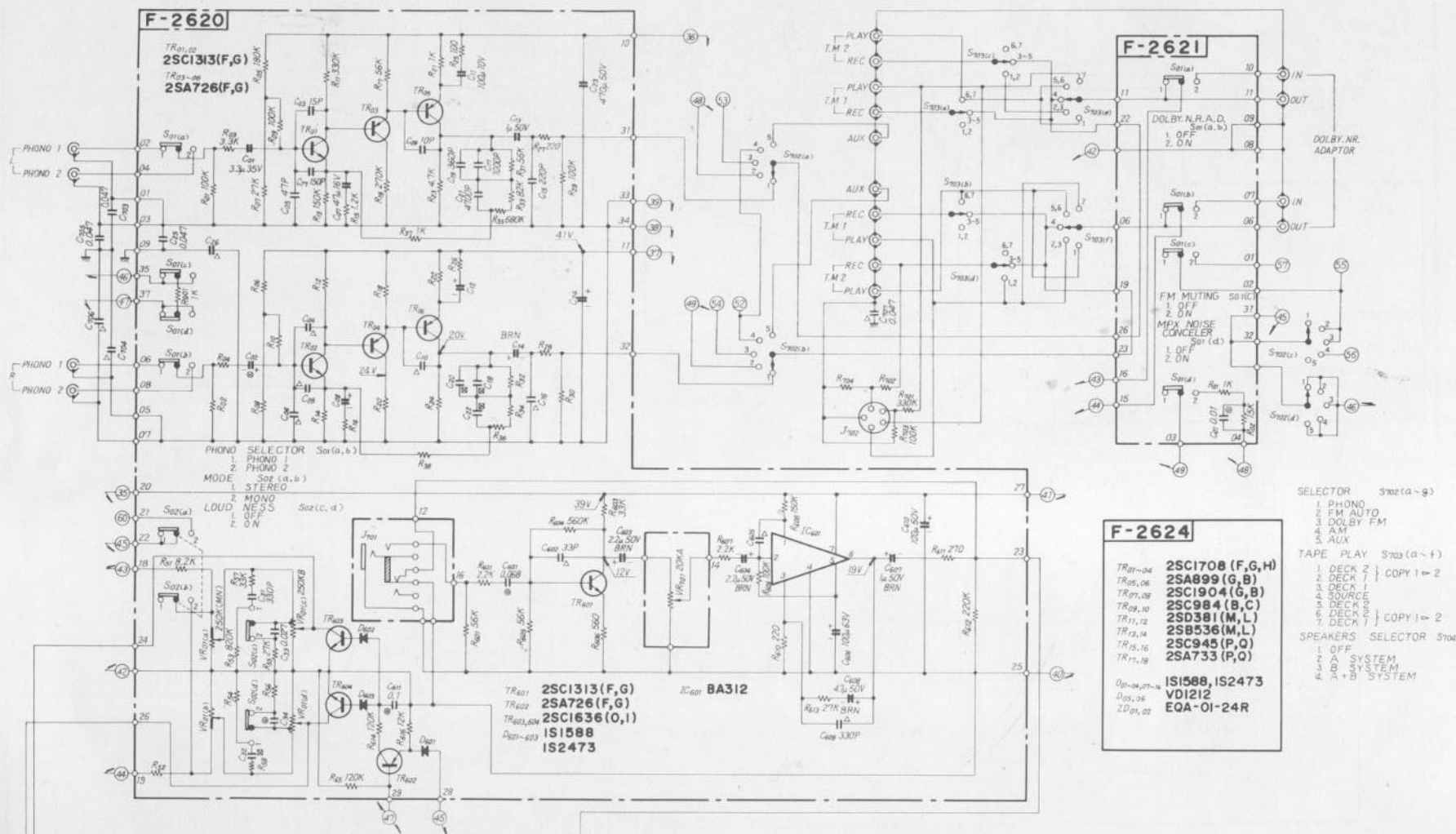

- La présentation et les spécifications sont susceptibles d'être modifiées sans préavis par suites d'améliorations éventuelles.
- Änderungen, die dem technischen Fortschritt dienen, bleiben vorbehalten.
- Design and specifications subject to change without notice for improvement.

