

SERVICE MANUAL

INTEGRATED STEREO AMPLIFIER

SANSUI A-707/505

(Silver & Black Model)

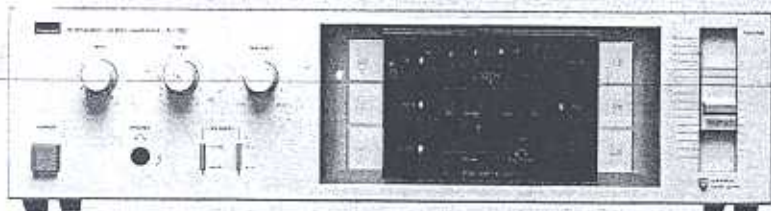

Classic-Audio-Service

HiFi-Service-Center

Heinz Deppermann, Dipl.-Ing.

service@cas-germany.com

Tel. +49 (0) 2065 - 959085

Sansui

SANSUI ELECTRIC CO., LTD.

2F3
A-707/505

• SPECIFICATIONS

• A-707

Power output

Min. RMS, both channels driven, from 20 to 20,000 Hz,
with no more than 0.06 % total harmonic distortion
50 watts per channel into 8 ohms

Load impedance 8 ohms

Total harmonic distortion

less than 0.06 % at or below
rated min. RMS power output

Frequency response (at 1 watt)

5 to 60,000 Hz
+1 dB, -2 dB

RIAA curve deviation (PHONO, 20 Hz to 20 kHz)

+0.5 dB, -0.5 dB

Input sensitivity and impedance (1 kHz, for rated power output)

PHONO 2.5 mV/47 kilohms
(Max. input capability, 120 mV at 1 kHz, less than
0.1 % total harmonic distortion)

TUNER, TAPE PLAY

150 mV/47 kilohms

Output level (1 kHz)

TAPE REC 130 mV into 47 kilohms

Signal to noise ratio (short-circuit, A-network)

PHONO 72 dB

TUNER, TAPE PLAY

90 dB

Power requirements

Power voltage 120/220/240 V (50/60 Hz)

For U.S.A. & Canada

120 V (60 Hz)

Power consumption

190 watts 225 VA Rated

270 watts Maximum

Dimensions 430 mm (16-1/2/16") W

118 mm (4-11/16") H

245 mm (9-11/16") D

Weight 4.9 kg (10.8 lbs.) net

5.7 kg (12.6 lbs.) packed

• A-505

Power output

Min. RMS, both channels driven, from 40 to 20,000 Hz,
with no more than 0.07 % total harmonic distortion
30 watts per channel into 8 ohms

Load impedance 8 ohms

Total harmonic distortion

less than 0.07 % at or below
rated min. RMS power output

Frequency response (at 1 watt)

10 to 50,000 Hz
+1 dB, -2 dB

RIAA curve deviation (PHONO, 30 Hz to 15 kHz)

+0.5 dB, -0.5 dB

Input sensitivity and impedance (1 kHz, for rated power output)

PHONO 2.5 mV/47 kilohms
(Max. input capability, 120 mV at 1 kHz, less than
0.1 % total harmonic distortion)

TUNER, TAPE PLAY

150 mV/47 kilohms

Output level (1 kHz)

TAPE REC 130 mV into 47 kilohms

Signal to noise ratio (short-circuit, A-network)

PHONO 72 dB

TUNER, TAPE PLAY

90 dB

Power requirements

Power voltage 120/220/240 V (50/60 Hz)

For U.S.A. & Canada

120 V (60 Hz)

Power consumption

120 watts 150 VA Rated

170 watts Maximum

Dimensions 430 mm (16-1/2/16") W

118 mm (4-11/16") H

245 mm (9-11/16") D

Weight 4.0 kg (8.8 lbs.) net

4.8 kg (10.6 lbs.) packed

* Design and specifications subject to changes without
notice for improvements.

2F3

1. BLOCK DIAGRAM

1-1. A-707

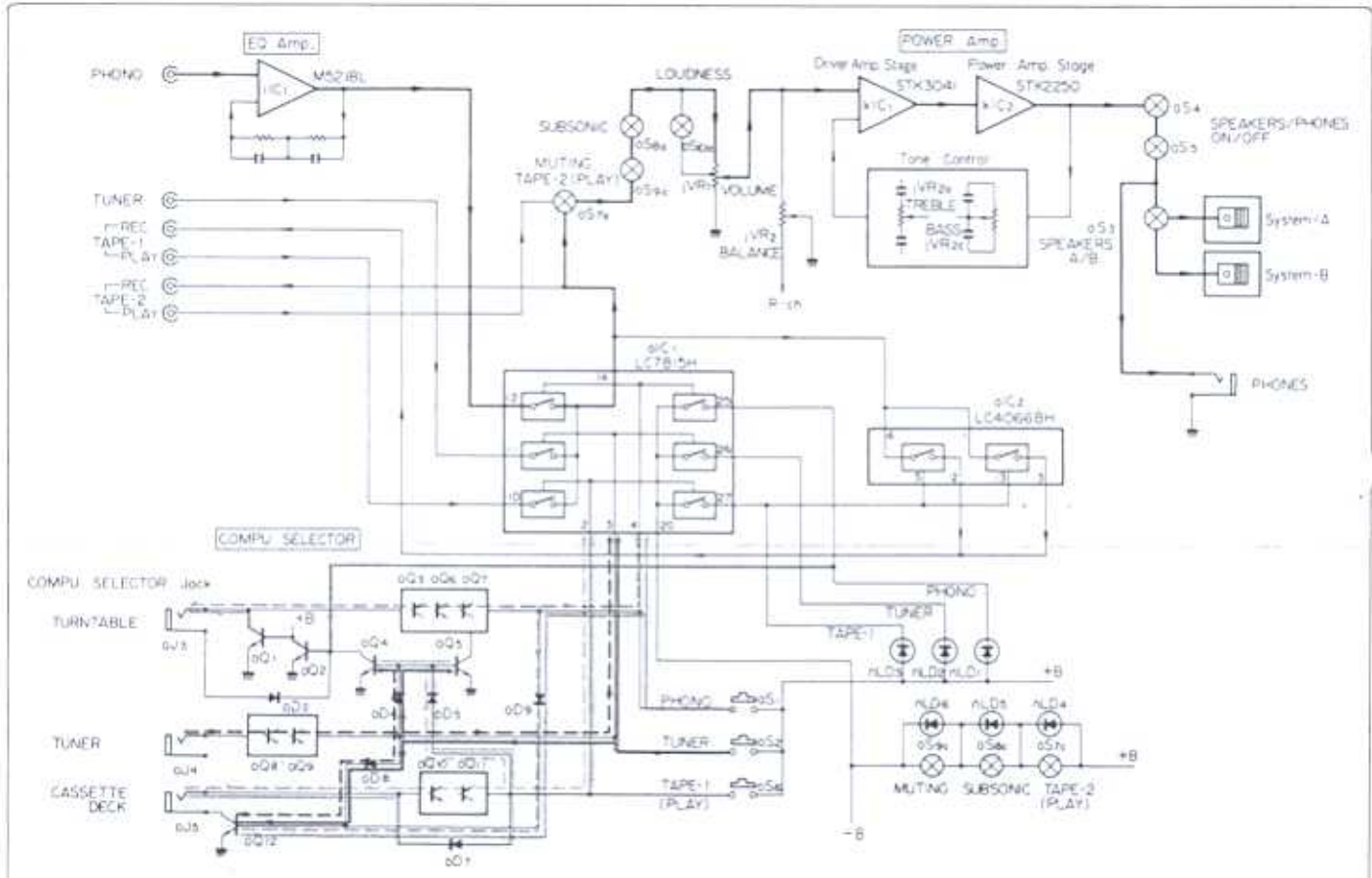

• LC7815H Analog Function Switch IC

• LC4066BH Quad Bilateral Switch IC

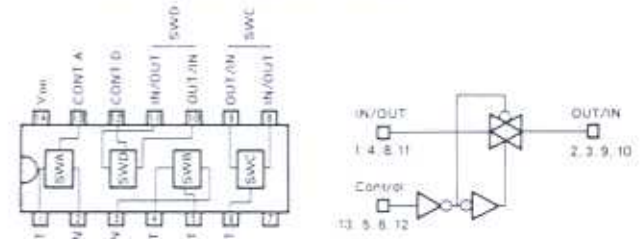
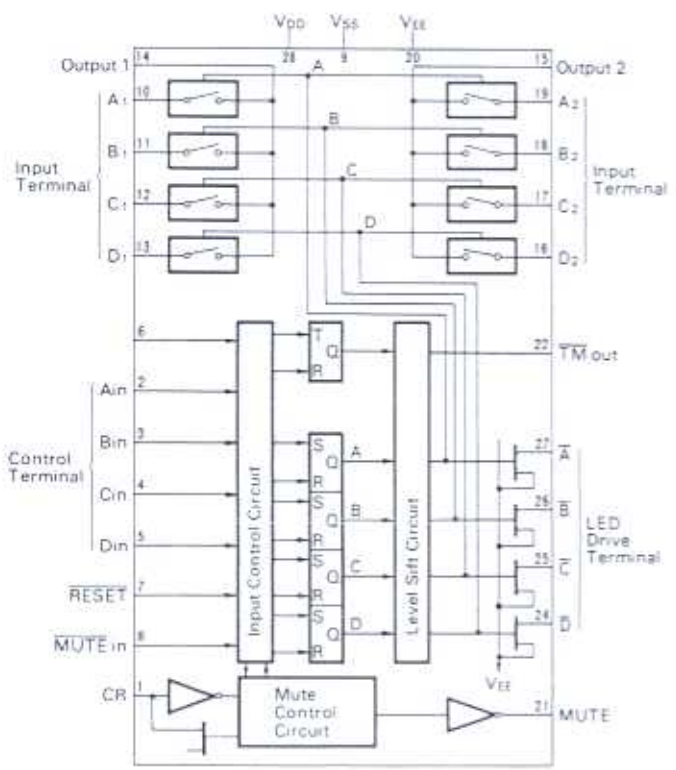

• LC7815H

Condition of control input terminals Port (Pin No.)				Connected input terminal to output 1 and 2 terminals		Connected terminal to LED indicator
Ain (2)	Bin (3)	Cin (4)	Din (5)	PORT (Pin No.)	PORT (Pin No.)	PORT (Pin No.)
H	H	H	H	A (10)	A (19)	A (27)
L	H	H	H	B (11)	B (18)	B (26)
L	L	H	H	C (12)	C (17)	C (25)
L	L	L	H	D (13)	D (16)	D (24)

H: H level L: L level *: Don't care

1-2. A-505

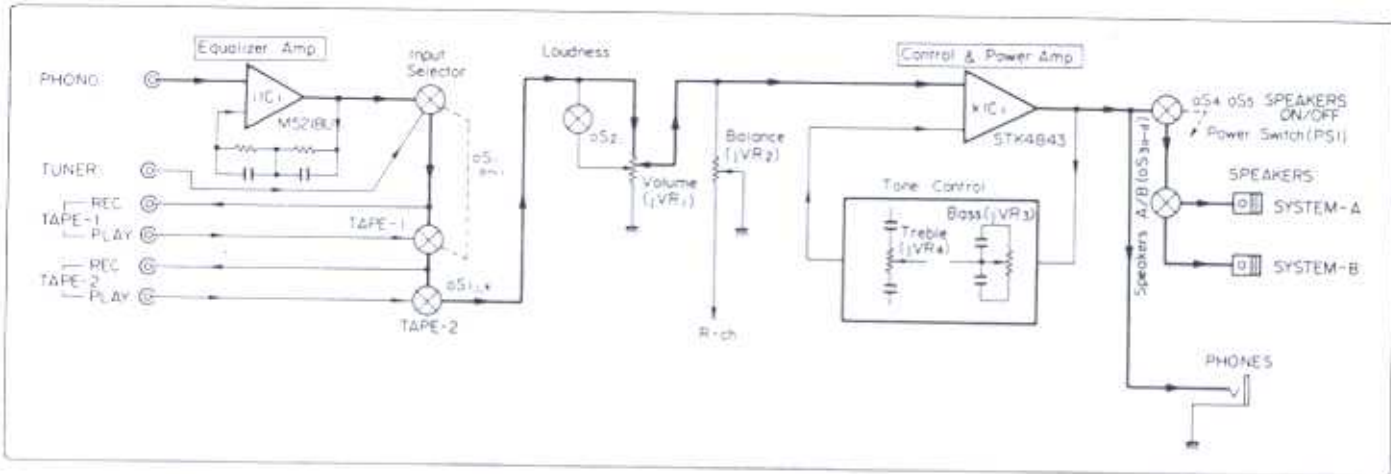

2. OPERATION OF COMPU SELECTOR <A-707> (See A-707 Block Diagram)

• The amplifier (A-707) has COMPU SELECTOR function which works with a tuner (T-707 or T-909), a turntable (P-D30, P-L40 or P-L50), a tape deck (D-77F, D-77R or D-99D).

A. Operation when one of the input selector switches of the amplifier is pushed

- When the PHONO switch is pushed, the platter of the turntable (P-L40 or P-L50) starts rotating and the tonearm automatically moves to play record.
- When the TUNER or TAPE-1 switch is pushed during record play, the tonearm returns to the arm rest and the platter stops rotating automatically.
- When the TAPE-1 switch is pushed, the cassette deck (D-77F or D-77R) starts automatically to playback a tape.

- When the PHONO or TUNER switch is pushed during tape playback, cassette deck stops automatically.

B. Operation when one of the function switches of combined unit is controlled

- 1) When the START/STOP switch of the turntable (P-D30, P-L40 or P-L50) is pushed, the input selector of the amplifier is automatically set to the PHONO mode.
- 2) When one of the FM/AM selection switch and the UP/DOWN switch of the tuner (T-707 or T-909) is pushed, or the tuning knob of the tuner is touched by hand, the input selector of the amplifier is automatically set to TUNER mode.
- 3) When the PLAY switch of the cassette deck is pushed, the input selector of the amplifier is automatically set to the TAPE-1 mode.

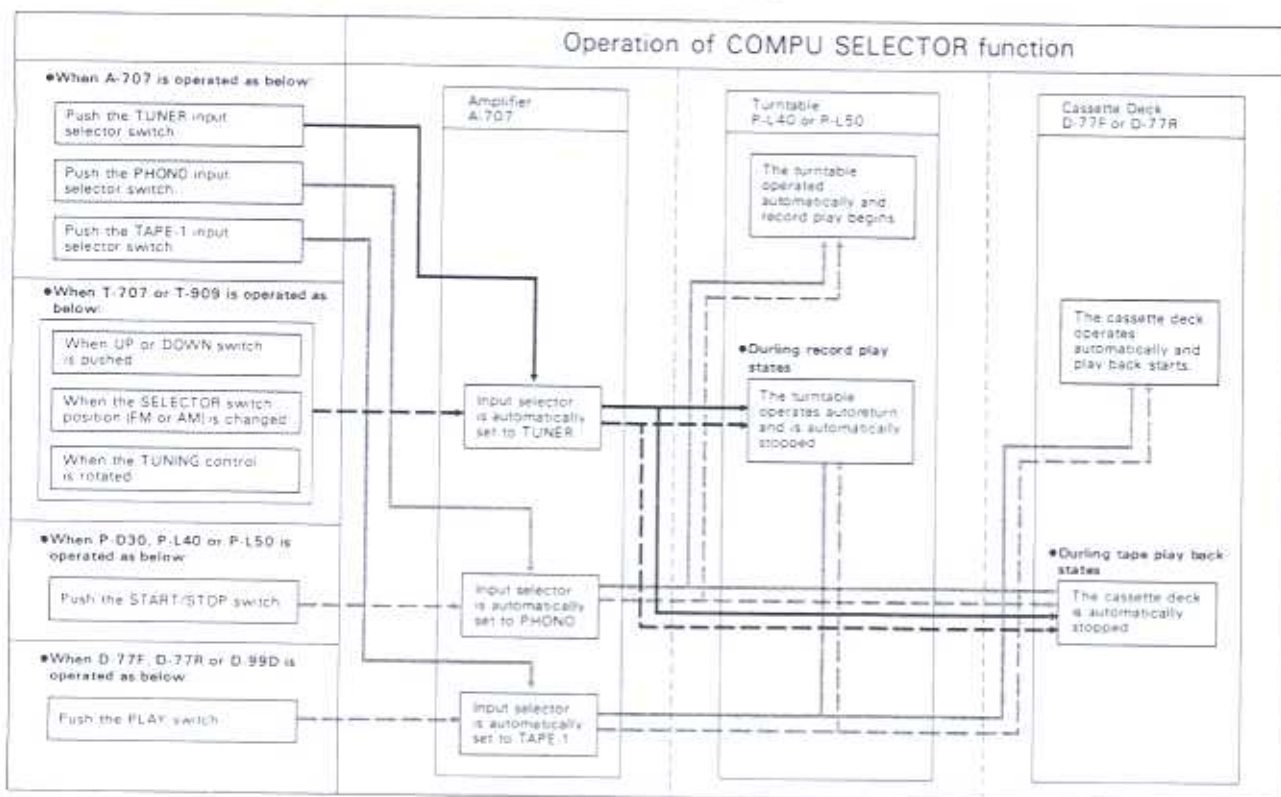

3. PARTS LOCATION & PARTS LIST

3-1. F-3729 Power Amp. & Power Supply Circuit Board (Stock No. 00704201) <A-707>

Component Side

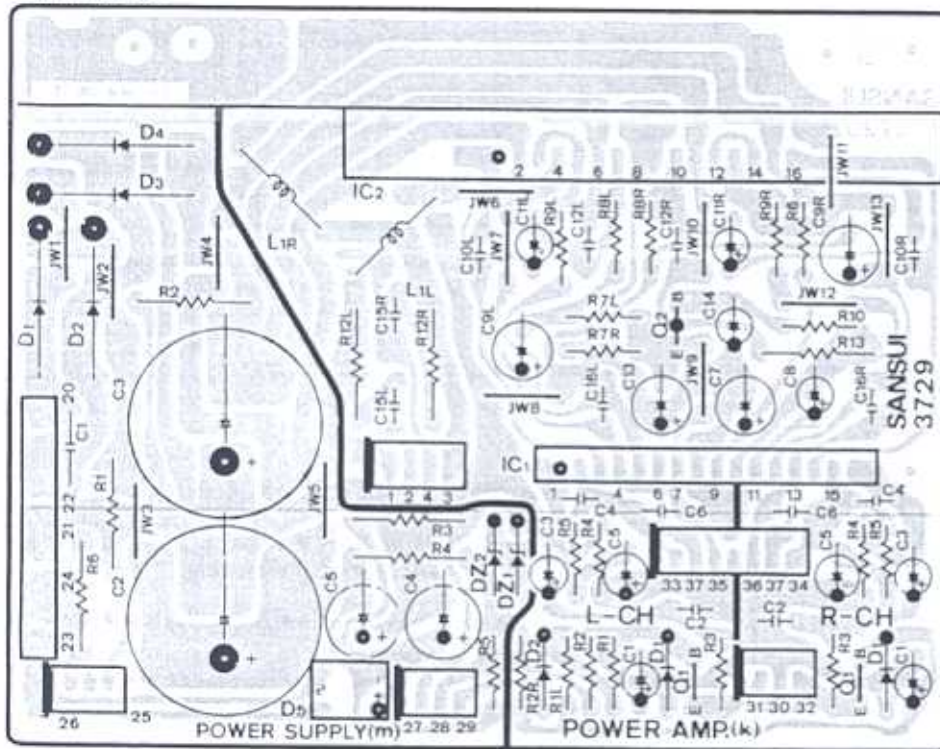

Parts List

Parts No.	Stock No.	Description	Parts No.	Stock No.	Description
• Transistor			• Diode		
kQ1	07194801	2SC1815	mD1	03115300	30D2
	or 46367301	2SC245B	mD2	03115300	30D2
kQ2	03010901	2SA992	mD3	03115300	30D2
• IC			mD4	03115300	30D2
kIC1	46395100	STK3041	mD5	46273600	DBB10-B
kIC2	46395000	STK2250	• Zener Diode		
• Diode			mDZ1	46113800	05Z12
kD1	03117600	1S2473D	mDZ2	46113800	05Z12
kD2	03117600	1S2473D	mR1	46251400	5.6k Ω 1W N.I.R.
kR6	46229000	100 Ω 1/2W N.I.R.	mR2	46251400	5.6k Ω 1W N.I.R.
kR9	46229400	220 Ω 1/2W N.I.R.	mR3	46249800	270 Ω 1W N.I.R.
kR11	46230200	1k Ω 1/2W N.I.R.	mR4	46249800	270 Ω 1W N.I.R.
kR12	46247700	4.7 Ω 1W N.I.R.	mR5	46229900	5.6k Ω 1/2W N.I.R.
kC2	46137200	220pF 50V C.C.	mC1	08680400	10000pF 500V C.C.
kC4	46137200	220pF 50V C.C.	mC2	46395200	4700 μ F 50V E.C.
kL1	46394500, 1	Inductor Coil	mC3	46395200	4700 μ F 50V E.C.

• Abbreviations

C.R.	Carbon Resistor	E.B.	Bi-Polar Electrolytic Capacitor
S.R.	Solid Resistor	E.B.L.	Low Leak Bi-Polar Electrolytic Capacitor
Ce.R.	Cement Resistor	Ta.C.	Tantalum Capacitor
M.F.	Metal Film Resistor	F.C.	Film Capacitor
F.R.	Fusing Resistor	M.P.	Metalized Paper Capacitor
N.I.R.	Non-Inflammable Resistor	P.C.	Polystyrene Capacitor
C.C.	Ceramic Capacitor	G.C.	Gummic Capacitor
C.T.	Ceramic Capacitor, Temperature Compensation	V.R.	Variable Resistor
E.C.	Electrolytic Capacitor	S.V.R.	Semi Variable Resistor
E.L.	Low Leak Electrolytic Capacitor	SW	Switch

• Since some of capacitors and resistors are omitted from parts lists in this Service Manual, refer to the Common Parts List for capacitors & resistors, which was appended previously to Sansui Manual.

3-2. F-3735 COMPU SELECTOR Control IC Circuit Board (Stock No. 00704701) <A-707>

Component Side

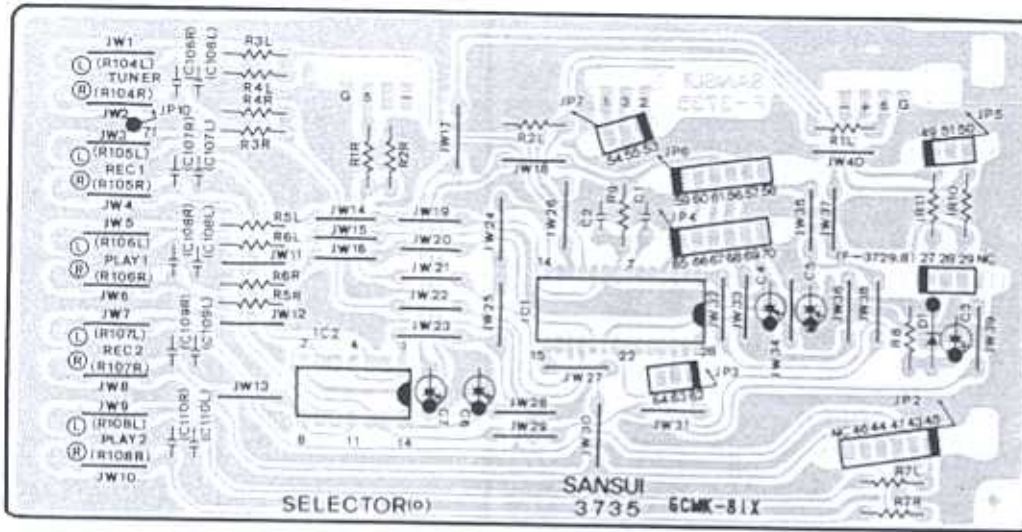

Parts List

Parts No.	Stock No.	Description	Parts No.	Stock No.	Description
R10	46229000	100Ω 1/2W N.I.R.	Diode		
R11	46229000	100Ω 1/2W N.I.R.	oD1	03117600	1S2473D
•IC				46371500	4P Input Terminal, TUNER/TAPE-1 (REC)
oIC1	46394800	LC7815H		46363900	6P Input Terminal, TAPE-1 (PLAY)/TAPE-2
oIC2	46255000	LC4066BH			

3-3. F-3739 COMPU SELECTOR Circuit Board (Stock No. 00705101) <A-707>

Component Side

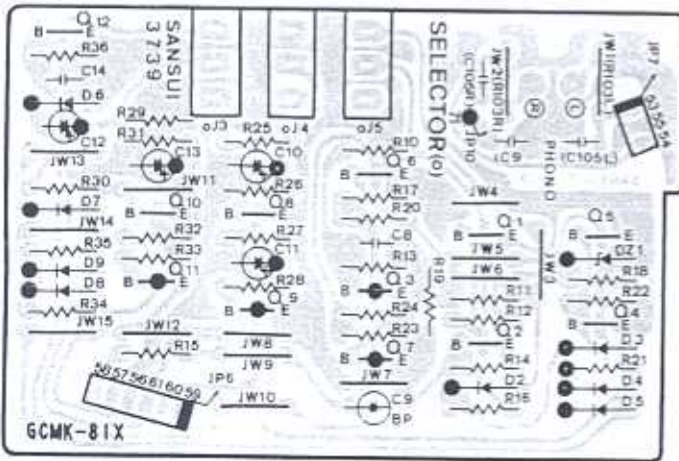

Parts List

Parts No.	Stock No.	Description	Parts No.	Stock No.	Description	Parts No.	Stock No.	Description
•Transistor			oQ9	07194701	2SA1015	oD9	03117600	1S2473D
oQ1	07194801	2SC1815	or 46367201	2SA1048				
oQ2	07194801	2SC1815	oQ10	07194801	2SC1815	•Zener Diode		
or 46367301	2SC2458	oQ11	07194701	2SA1015	oDZ1	46111200	05Z5.1	
oQ3	07194701	2SA1015	or 46367201	2SA1048	oC9	08450800	3.3μF 16V E.B.	
or 46367201	2SA1048	oQ12	07194801	2SC1815	oJ3	46148200	Jack (Mini), COMPU SELECTOR	
oQ4	07194801	2SC1815	or 46367301	2SC2458	oJ4	46148200	Jack (Mini), COMPU SELECTOR	
or 46367301	2SC2458	•Diode			oJ5	46148200	Jack (Mini), COMPU SELECTOR	
oQ5	07194801	2SC1815	oD2	03117600	1S2473D			
or 46367301	2SC2458	oD3	03117600	1S2473D				
oQ6	07194801	2SC1815	oD4	03117600	1S2473D			
or 46367301	2SC2458	oD5	03117600	1S2473D				
oQ7	07194701	2SA1015	oD6	03117600	1S2473D			
or 46367201	2SA1048	oD7	03117600	1S2473D				
oQ8	07194801	2SC1815	oD8	03117600	1S2473D	46363700	2P Input Terminal, PHONO	
or 46367301	2SC2458							

3-4. F-3730 Power Amp. & Power Supply Circuit Board (Stock No. 00695801) <A-505>

Component Side

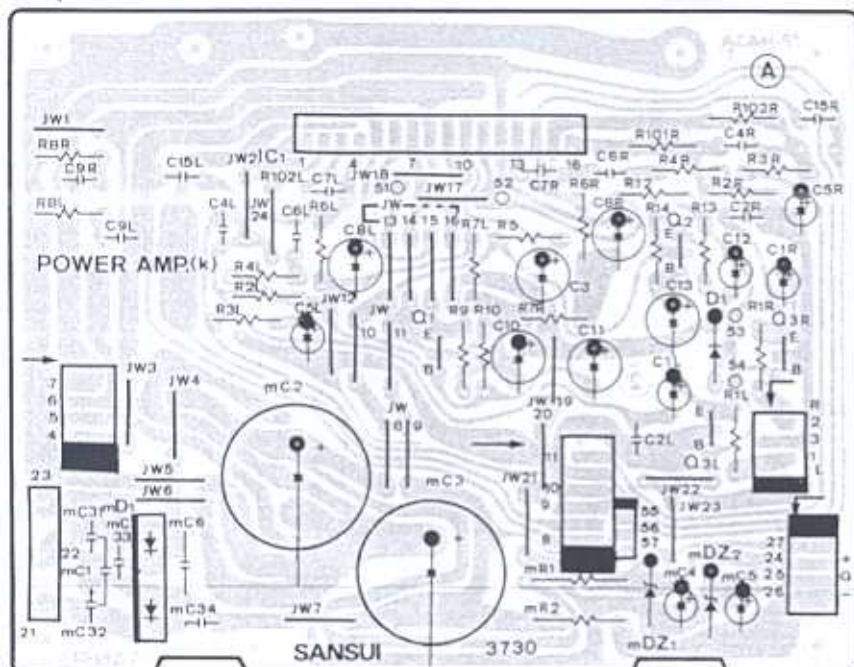

Parts List

Parts No.	Stock No.	Description
• Transistor		
kQ1	07194701	2SA1015
• IC		
xIC1	46367600	STK4843
kR5	46229000	100Ω 1/2W N.I.R.
kR8	46227800	10Ω 1/2W N.I.R.
kR9	46229000	100Ω 1/2W N.I.R.
kC2	46137400	330pF 50V C.C.
kC4	46137400	330pF 50V C.C.
kC6	46137600	470pF 50V C.C.

Parts No.	Stock No.	Description
• Diode		
mD1	03117000	RB-152
• Zener Diode		
mD21	46115400	05Z20
mD22	46115400	05Z20
mR1	46250300	680Ω 1W N.I.R.
mR2	46250300	680Ω 1W N.I.R.
mC1	06680400	10000pF 50V C.C.
mC2	46363300	3900μF 42V E.C.
mC3	46363300	3900μF 42V E.C.

3-5. F-3725 EQ. Amp. Circuit Board (Stock No. 00695501) <A-707/A-505>

Component Side

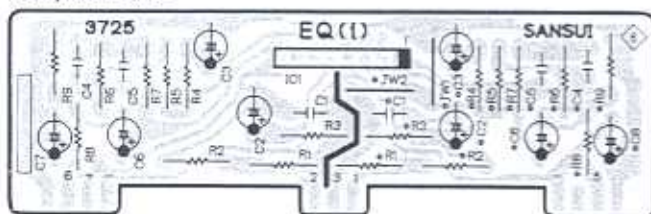

Parts List

Parts No.	Stock No.	Description
• IC		
iIC1	46078900	M5218L
iC1	46137200	220pF 50V C.C.

3-6. F-3726 Tone Control Circuit Board <A-707/A-505>

Component Side

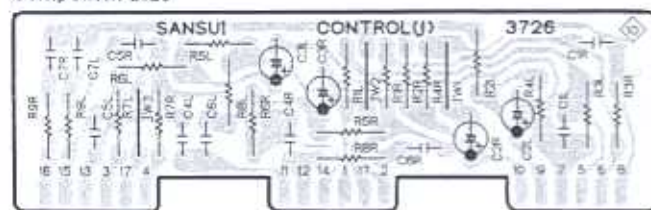

Parts List

Parts No.	Stock No.	Description
iC7	07216800	68000pF 25V C.C.

Note: This circuit board is not supplied as the assembled. However, individual parts on the circuit board are provided by order.

• Note: The circuit boards, F-3736, F-3737, F-3738, F-3740, F-3741, F-3742, F-3743, F-3744, F-3727, F-3731 & F-3732 are not supplied as the assembled. However, the individual parts on the circuit boards are provided by orders.

3-7. F-3736 Input Selector Switch & Indicator Circuit Board <A-707>

Component Side



Parts List

Parts No.	Stock No.	Description
nLD1	46176900	LED TLS-123
nLD2	46176900	LED TLS-123
nLD3	46176900	LED TLS-123
nLD4	46176900	LED TLS-123
nLD5	46176900	LED TLS-123
nLD6	46176900	LED TLS-123
nPL1	46315900	Pilot Lamp 12V 1.5A
oS1	46395900	Push SW., PHONO
oS2	46395900	Push SW., TUNER
oS6	46395900	Push SW., TAPE-1
oS7	46365400	Push SW., TAPE-2
oS8	46365400	Push SW., SUBSONIC
oS9	46365400	Push SW., MUTING

3-8. F-3737 BASS/TREBLE/BALANCE Volume Circuit Board <A-707>

Component Side



Parts List

Parts No.	Stock No.	Description
vVR2	46363100	50kΩ (C1) x 2 + 250kΩ

3-9. F-3738 VOLUME Circuit Board <A-707>

Component Side

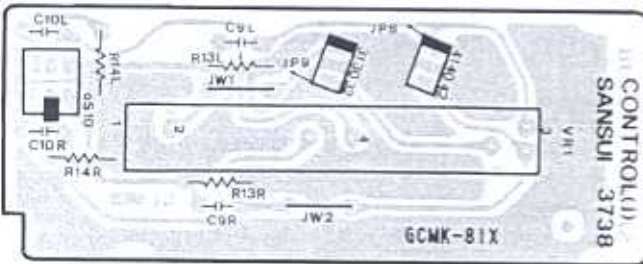

Parts List

Parts No.	Stock No.	Description
jC9	46137600	470pF 50V C.C.
jC10	07216200	22000pF 25V C.C.
vVR1	46395300	150kΩ Slide V.R., VOLUME
oS10	46360900	Push SW., LOUDNESS

3-10. F-3740 Input Terminal Circuit Board <A-505>

Component Side



Parts List

Parts No.	Stock No.	Description
rR10	46230400	1.5kΩ 1/2W N.I.R.
rR11	46230400	1.5kΩ 1/2W N.I.R.
mR4	46229000	100Ω 1/2W N.I.R.
mR5	46229000	100Ω 1/2W N.I.R.
oS1	46365600	Push SW., PHONO/TUNER/TAPE-1
	46363700	2P Input Terminal, PHONO
	46371500	4P Input Terminal, TUNER, TAPE-1, REC
	46363900	6P Input Terminal, TAPE-1 PLAY, TAPE-2

3-11. F-3741 PHONO/TUNER Indicator Circuit Board <A-505>

Component Side

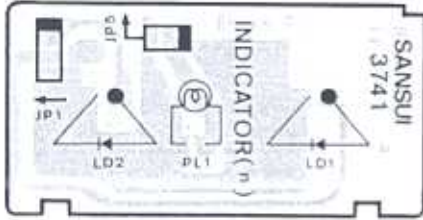

Parts List

Parts No.	Stock No.	Description
nLD1	46176900	Light Emitting Diode T.LS-123
nLD2	46176900	Light Emitting Diode T.LS-123
nPL1	46315900	Pilot Lamp 12V 1.5A

3-12. F-3742 TAPE Indicator Circuit Board <A-505>

Component Side

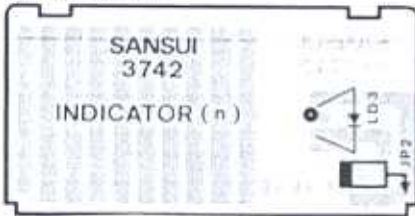

Parts List

Parts No.	Stock No.	Description
nLD3	46176900	Light Emitting Diode T.LS-123

3-13. F-3743 VOLUME Circuit Board <A-505>

Component Side

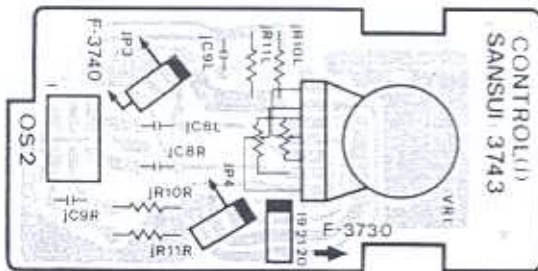

Parts List

Parts No.	Stock No.	Description
jC8	46139800	330pF 50V C.C.
jC9	46131400	0.022μF 50V C.C.
jVR1	46362900	150kΩ (B) x 2 V.R., VOLUME
oS2	46360900	Push SW., LOUDNESS

3-14. F-3744 BASS/TREBLE/BALANCE Volume Circuit Board <A-505>

Component Side



Parts List

Parts No.	Stock No.	Description
jVR2	46363100	50kΩ (C) x 2 + 250kΩ V.R.

3-15. F-3727 POWER Switch Circuit Board <A-707/A-505>

Component Side

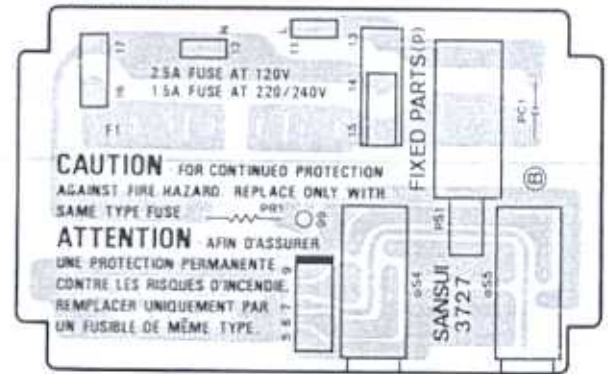

Parts List

Parts No.	Stock No.	Description
oS4	46414001	Push SW., speakers ON/OFF <A-707>
oS5	46360800	Push SW., speakers ON/OFF <A-505>
oS5	46360800	Push SW., speakers ON/OFF <A-707/505>
•AC Fuse <A-707>		
pF1	07189000	4A 250V (120V)
pF1	07186600	2A 250V (220/240V)
<A-505>		
pF1	07188700	2.5A 250V (120V)
pF1	07188500	1.5A 250V (220/240V)
pS1	46364300	Push SW., POWER

3-16. F-3731 Speaker Selector Circuit Board <A-707/A-505>

Parts List

Parts No.	Stock No.	Description
kR11	46229400	220Ω 1/2W N.I.R. <A-505>
oS3	46361100	Push SW., SP selector
oJ1	46265700	Jack, PHONES

3-17. F-3732 Speaker Terminal Circuit Board <A-707/A-505>

Parts List

Parts No.	Stock No.	Description
kR101.2	46227400	4.7Ω 1/2W N.I.R. <A-707>
kR101.2	46227800	10Ω 1/2W N.I.R. <A-505>
	46364100	8P Push Terminal, speaker

4. OTHER PARTS

4-1. A-707

A) Front View

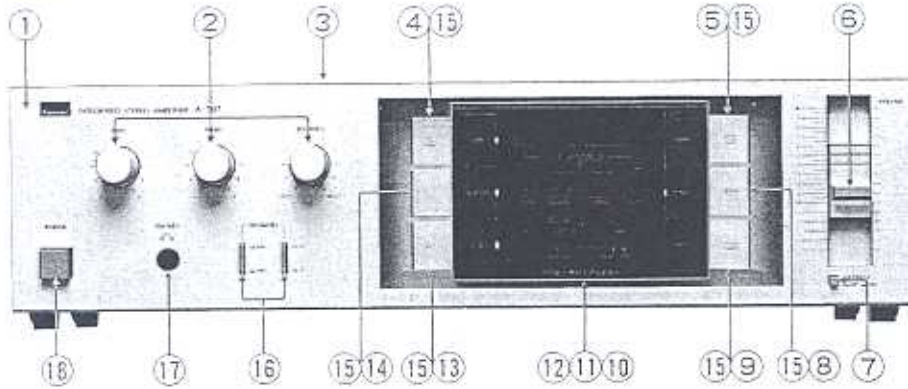

B) Top View

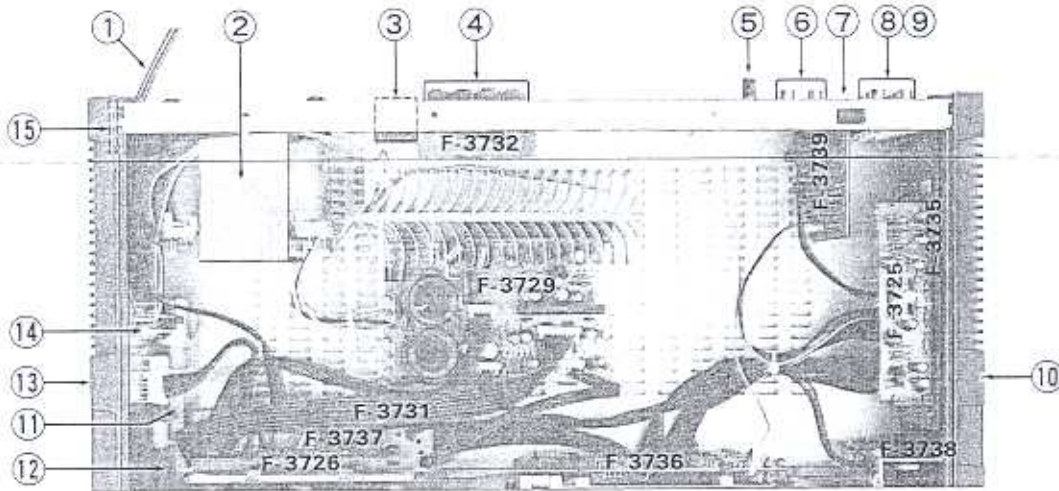

Parts List <Front View>

Parts No.	Stock No.	Description
●Common Parts		
2	46363100	50k Ω (C) x 2 + 250k Ω V.R., BASS/TREBLE/BALANCE
3	07952400	Bonnet
4	07925800	Knob, TAPE-2
	46365400	Push SW., TAPE-2
5	07925500	Knob, PHONO
	46395900	Push SW., PHONO
6	46395300	150k Ω Slide V.R., VOLUME
7	46360900	Push SW., LOUDNESS
8	07925600	Knob, TUNER
	46395900	Push SW., TUNER
9	07925700	Knob, TAPE-1
	46385900	Push SW., TAPE-1
10	07945100	Display Cover
13	07925100	Knob, MUTING
	46365400	Push SW., MUTING
14	07925200	Knob, SUBSONIC
	46365400	Push SW., SUBSONIC
15	07962600	Cushion Rubber
16	46361100	Push SW., SPEAKERS
17	46265700	Jack, PHONES
18	46364300	Push SW., POWER
●Silver Model		
1	07933300	Front Panel
2	07932400	Knob, BASS/TREBLE/BALANCE
6	07932600	Slide Knob, VOLUME
7	07917200	Push Knob, LOUDNESS
11	47009600	Display Panel
12	47011500	Display Holder
16	47005500	Push Knob, SPEAKERS
18	07971200	Push Knob, POWER

Parts No.	Stock No.	Description
●Black Model		
1	07962100	Front Panel
2	47033300	Knob, BASS/TREBLE/BALANCE
6	07932700	Slide Knob, VOLUME
7	07917300	Push Knob, LOUDNESS
11	07954300	Display Panel
12	07947900	Display Holder
16	07911000	Push Knob, SPEAKERS
18	07911200	Push Knob, POWER

Parts List <Top View>

Parts No.	Stock No.	Description
1	38004700	Power Supply Cord
2	15008701	Power Transformer
3	46365000	AC Outlet
4	46364100	8P Push Terminal, SPEAKERS
5	22301500	Ground Terminal
6	46363700	2P Input Terminal, PHONO
7	46148200	Jack (Mini), COMPU SELECTOR
8	46371500	4P Input Terminal, TUNER/TAPE-1 (REC)
9	46363900	6P Input Terminal, TAPE-1 (PLAY)/TAPE-2
10	07952700	Side Panel (R)
11	07934000	Joint Shaft (B), POWER SW.
12	07934100	Joint Shaft (C), POWER SW.
13	07952600	Side Panel (L)
14	07189000	AC Fuse 4A 250 V (120 V)
	07188600	AC Fuse 2A 250 V (220 V/240 V)
15	07917700	AC Cord Cover

4-2. A-505
A) Front View

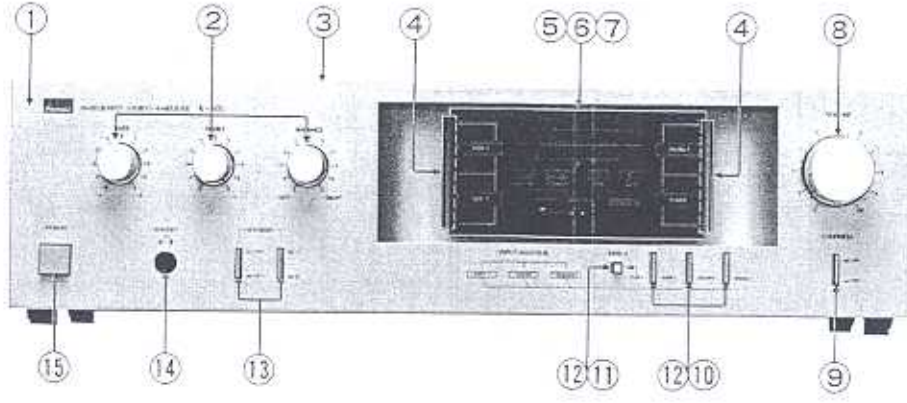

B) Top View

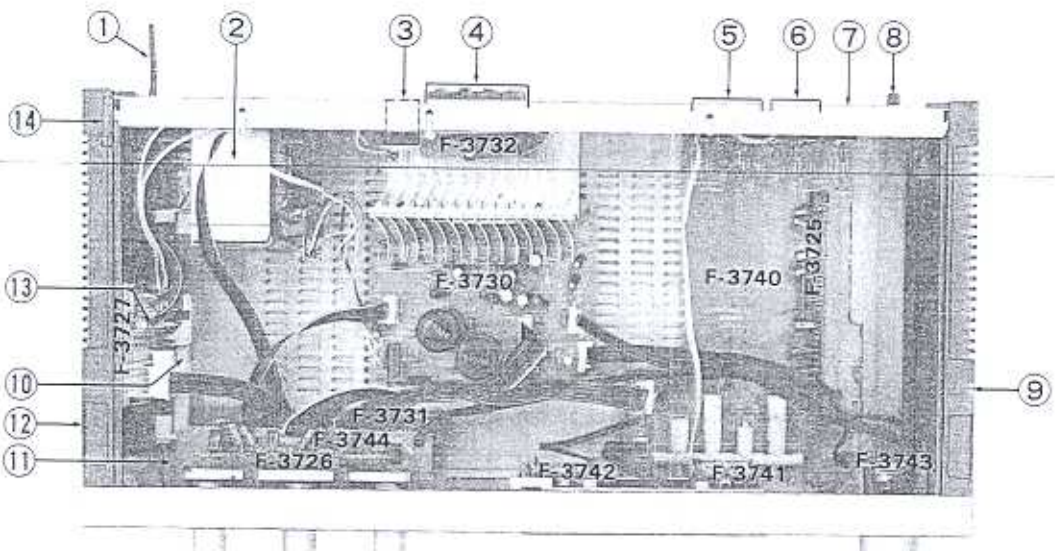

Parts List <Front View>

Parts No.	Stock No.	Description
●Common Parts		
2	46383100	50kΩ IC) x 2 + 250kΩ V.R., BASS/TREBLE/BALANCE
3	07952400	Bonnet
4	07918400	Dress Knob
5	07919200	Display Cover
8	46362900	150kΩ (B) x 2 V.R., VOLUME
9	46360900	Push SW., LOUDNESS
12	46365600	Push SW., PHONO/TUNER/TAPE-1, 2
13	46361000	Push SW., SPEAKERS
14	46265700	Jack, PHONES
15	46364300	Push SW., POWER
●Silver Model		
1	07918300	Front Panel
2	07932400	Knob, BASS/TREBLE/BALANCE
6	47009500	Display Panel
7	47011700	Display Holder
8	07961800	Knob, VOLUME
9	07910900	Push Knob, LOUDNESS
10	07910900	Push Knob, PHONO/TUNER/TAPE-1
11	07917200	Push Knob, TAPE-2
13	47005500	Push Knob, SPEAKERS
15	07971200	Push Knob, POWER
●Black Model		
1	07961900	Front Panel
2	47033300	Knob, BASS/TREBLE/BALANCE
6	07954400	Display Panel
7	07935500	Display Holder
8	47033400	Knob, VOLUME

Parts No.	Stock No.	Description
9	07911000	Push Knob, LOUDNESS
10	07911000	Push Knob, PHONO/TUNER/TAPE-1
11	07917300	Push Knob, TAPE-2
13	07911000	Push Knob, SPEAKERS
15	07911200	Push Knob, POWER

Parts List <Top View>

Parts No.	Stock No.	Description
1	38004700	Power Supply Cord
2	15007901	Power Transformer
3	46365000	AC Outlet
4	46364100	8P Push Terminal, SPEAKERS
5	46363900	6P Input Terminal, TAPE-1 (PLAY)/TAPE-2
6	46371500	4P Input Terminal, TUNER/TAPE-1 (REC)
7	46363700	2P Input Terminal, PHONO
	22301500	Ground Terminal
	07952700	Side Panel (R)
	07934000	Joint Shaft (B), POWER SW.
	07934100	Joint Shaft (C), POWER SW.
	07952600	Side Panel (L)
13	07188700	AC Fuse 2.5A 250 V (120 V)
	07188500	AC Fuse 1.5A 250 V (220 V/240 V)
14	07917700	AC Cord Cover

5. SCHEMATIC DIAGRAM 5-1. A-707

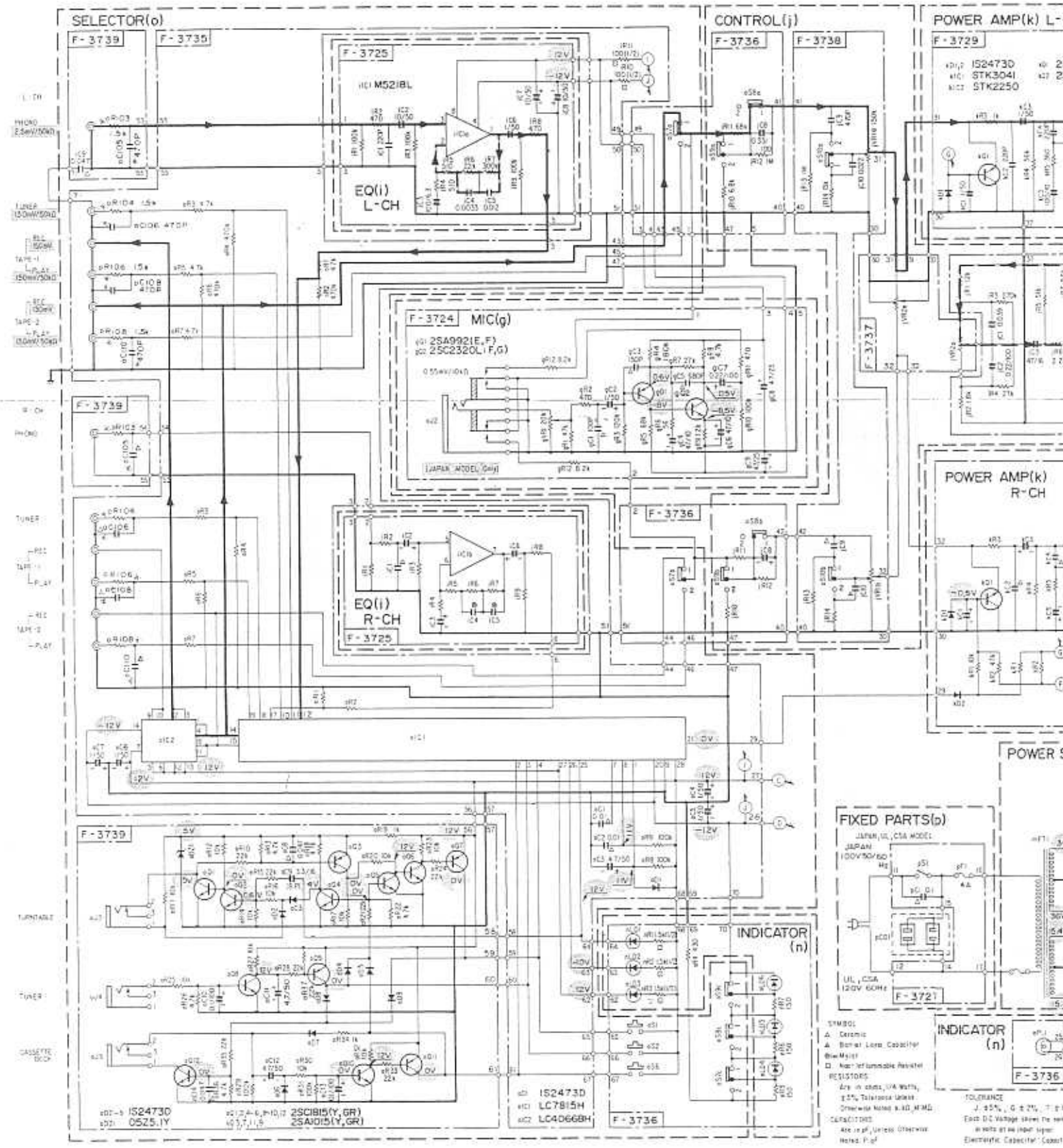

407-5 IS2473D
 4071 OS251Y
 412A-6, P-10, 12
 45, 7, 1, 8
 25CIB15(Y, GR)
 25AD15(Y, GR)

410 IS2473D
 411 LC7815H
 412 LC4066BH
 F-3736

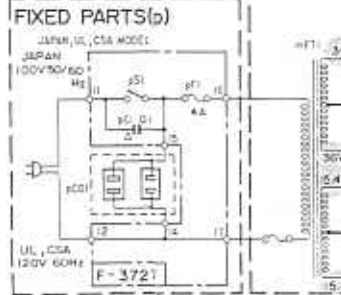

SYMBOL

- △ Ceramic
- ▲ Barium Ferrite Capacitor
- Mylar
- Non-ferromagnetic Resistor

RESISTORS

Are in ohms, 1/4 Watts,
 ±5% Tolerance unless
 Otherwise Noted & 1/2 WATT

CAPACITORS

Are in pF, unless Otherwise
 Noted. P-pf

TOLERANCE

J: ±5%, G: ±2%, T: ±10%

Each DC Voltage shown in series
 in note at the right applies.

Electric Co. Capacitor Co.

* Design and specifications subject to change without notice for improvement.
 * La présentation et les spécifications sont susceptibles d'être modifiées sans préavis par suites d'améliorations éventuelles.
 * Änderungen, die dem technischen Fortschritt dienen, bleiben vorbehalten.

POWER AMP(k) L-CH

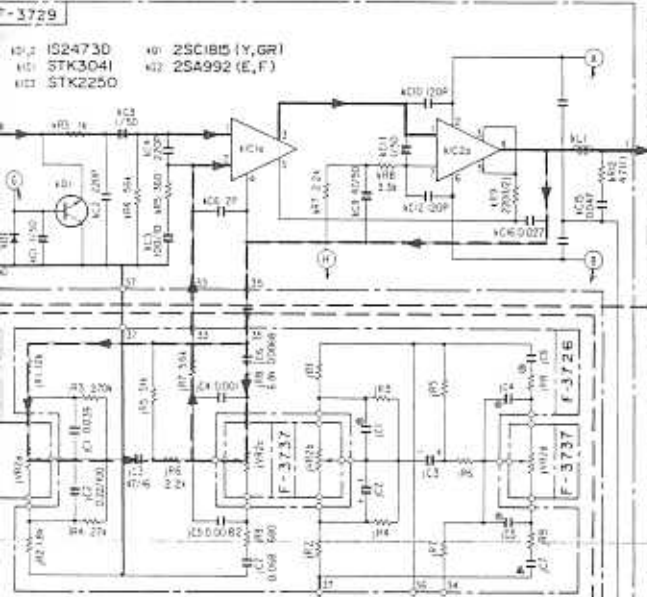

POWER AMP(k) R-CH

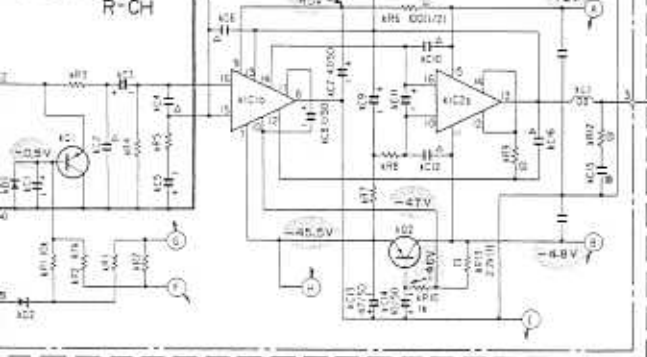

SELECTOR(o)

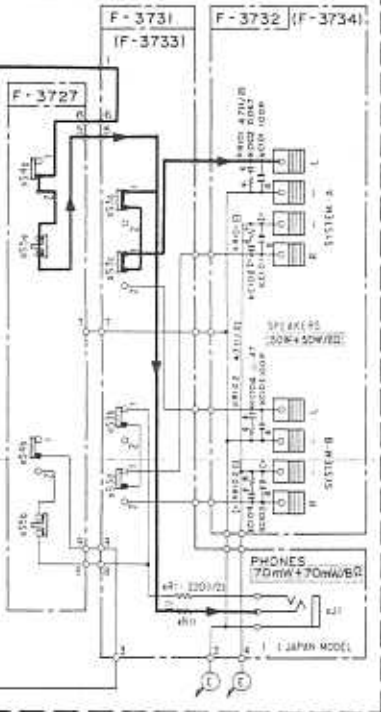

- SWITCHES
 SELECTOR (F-3731) 452a, 1 OFF 2 ON
 451 PHONO 452a, 1 OFF 2 ON
 452 TUNER 452a, 1 OFF 2 ON
 456 TAPE PLAY 456a, 1 OFF 2 ON
 457c TAPE PLAY 2 OFF 2 ON
 SUBSONIC (F-3732) 458a, 1 OFF 2 ON
 MUTING (F-3733) 459a, 1 OFF 2 ON
 LOUNGE (F-3734) 459a, 1 OFF 2 ON
- SPEAKERS
 452a, 1 (F-3731) 1 ON 2 OFF
 1, 4 SYSTEM 1 2 SYSTEM 2
 454a, 1 OFF 2 ON
 455c

POWER SUPPLY(m)

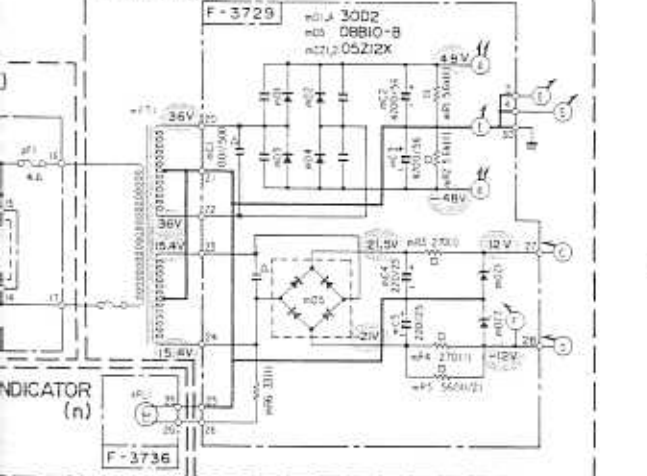

INDICATOR (n)



TOLERANCE
 J ± 5%, G ± 2%, T ± 1%
 Each D.C. voltage shows the nominal value
 in volts at no load (open)
 Electrolytic Capacitor: Capacitance(±) / voltage

OPTIONAL USE FOR TRANSISTORS
 25C1815 (25C2458, 25C2603, 25C2758)
 25A1015 (25A1048, 25A1115, 25A1175)

— Signal Line
 - - - N.F.B. Line

- 25A1015
- 25A1048
- 25A1115
- 25C1815
- 25C2458
- 25C2603
- 25A1175
- 25C2758
- M5218L
- LC4066BH
- LC7815H
- STK2250
- STK3041
- DBB10-B
- 300D
- 152473D
- 05212
- 0526.1

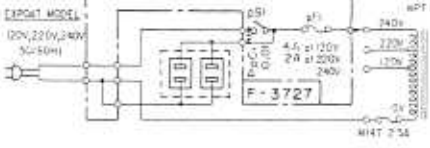
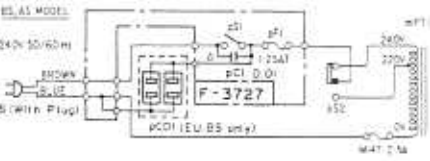
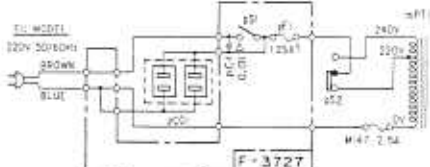

1

2

3

4

5

A

B

C

D

5-2. A-505

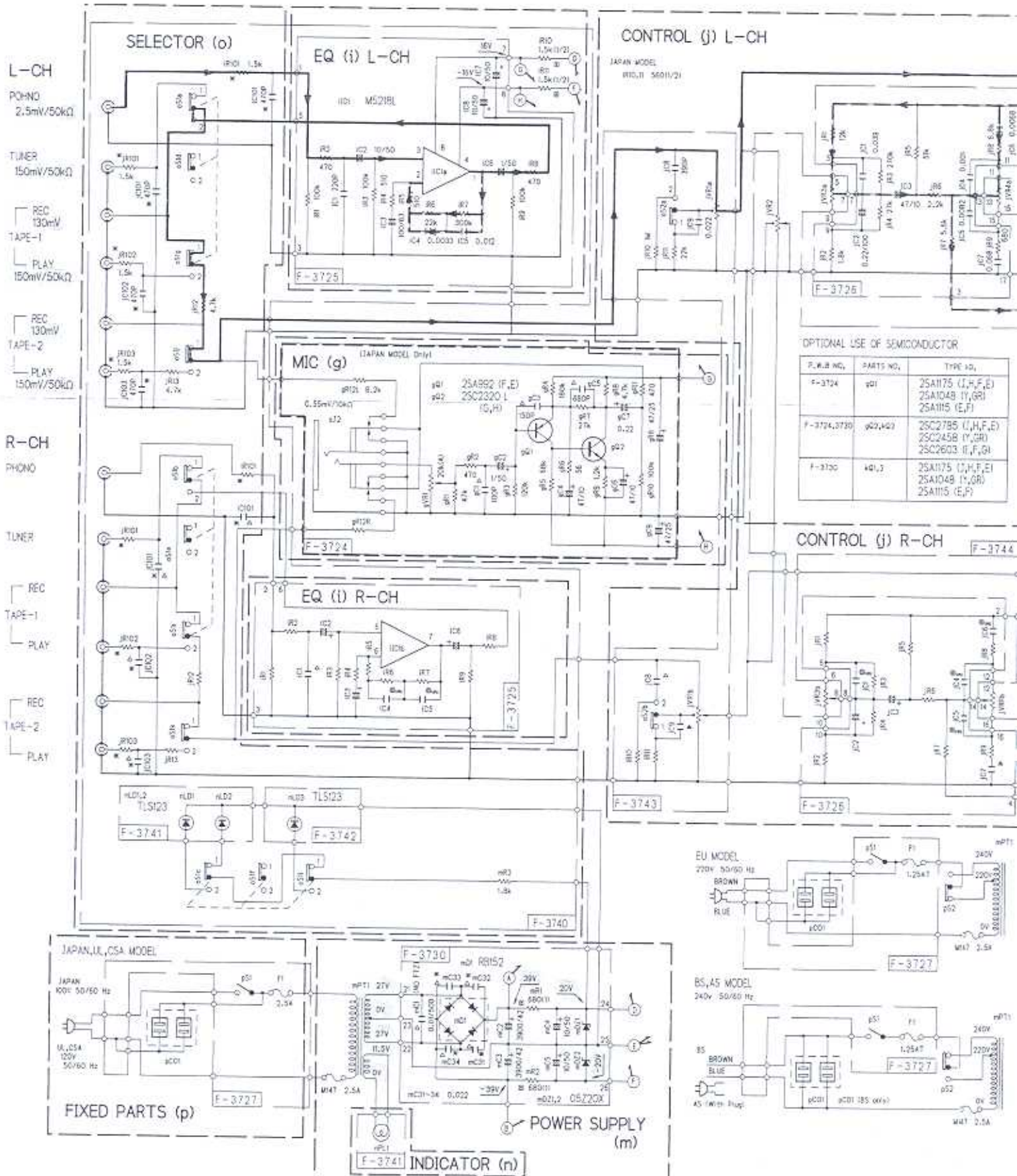

E

F

G

H

• Design and specifications subject to change without notice for improvement.
 • La présentation et les spécifications sont susceptibles d'être modifiées sans préavis par suites d'améliorations éventuelles.
 • Änderungen, die dem technischen Fortschritt dienen, bleiben vorbehalten.

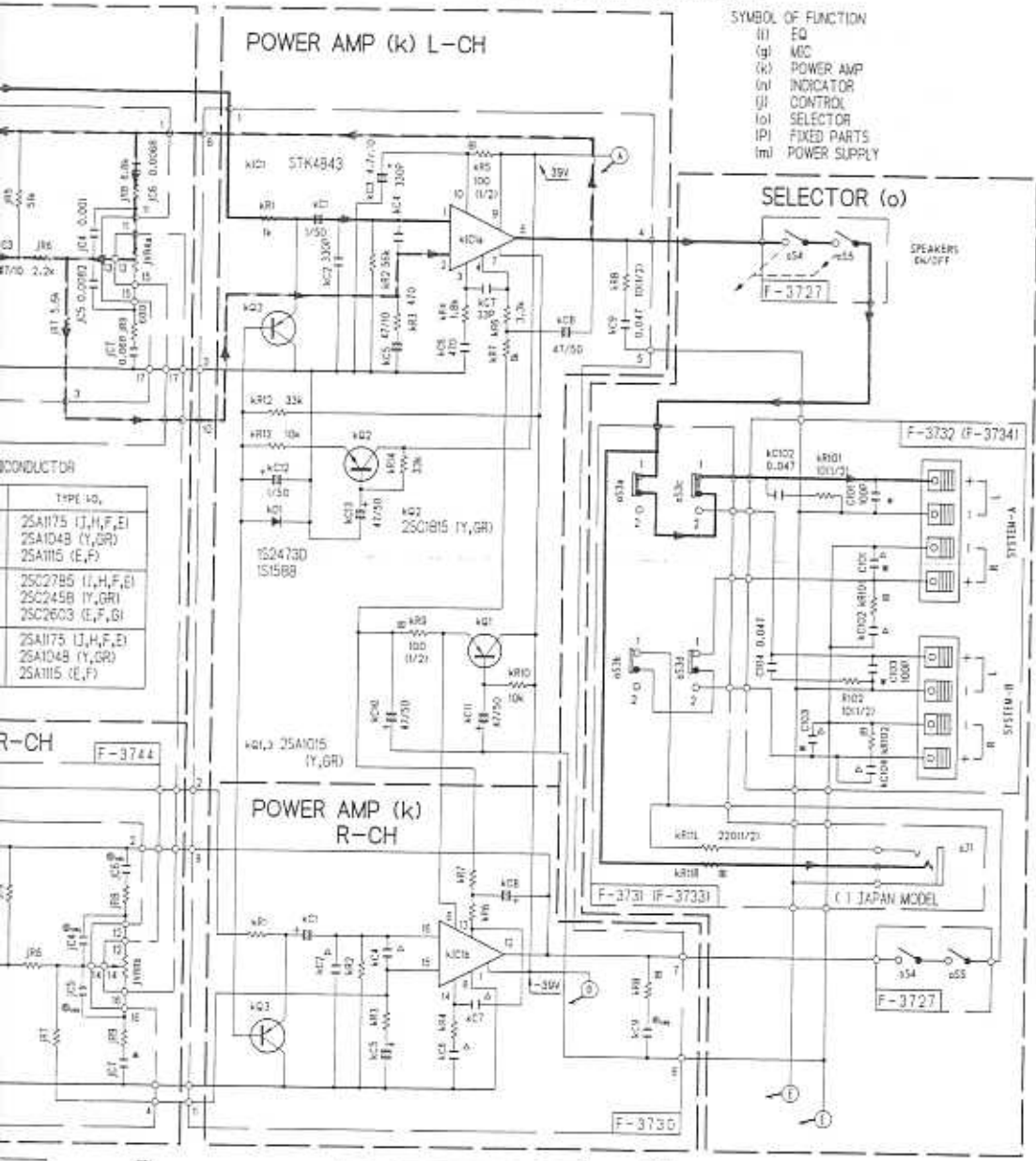

SYMBOL OF FUNCTION
 (i) EQ
 (g) MC
 (k) POWER AMP
 (n) INDICATOR
 (j) CONTROL
 (o) SELECTOR
 (p) FIXED PARTS
 (m) POWER SUPPLY

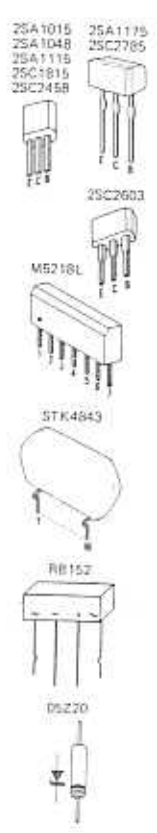

1
2
3
4
5

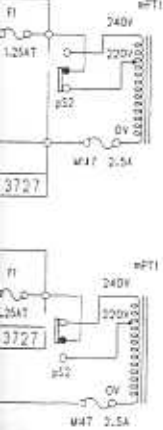

EXPORT MODEL
 100V, 220V, 240V
 50-60 Hz

SWITCH
 SELECTOR (F-3740)
 s51a-c 2, PHONO
 s51b-f 2, TUNER
 s51c-i 2, TAPE PLAY-1
 s51j-a 2, TAPE PLAY-2
 LOUDNESS (F-3743)
 s52a,b 1, OFF 2, ON

SPEAKERS (F-3731)
 s53a,p 1, ON 2, OFF (F-3733)
 s53c,d 1, SYSTEM-A
 2, SYSTEM-B

POWER (F-3727)
 s51 1, OFF 2, ON
 s54, s55
 Muting

SMDS
 ▲ Ceramic
 ▲ Barrier Layer Capacitor
 ● Mylar
 ■ Non-Inflammable Polyester

RESISTORS
 Are in ohms, 1/4 Watts, 5% Tolerance
 (Unless Otherwise Noted, R-KΩ, M-MΩ)

CAPACITORS
 Are in μF, Unless Otherwise Noted, P-pF

TOLERANCE
 J ±5% G ±2% F ±1%

Each D.C. Voltage shows the nominal value
 in volts at no input signal.
 Electrolytic Capacitor Capacitance (μF)/Rated VV

• FT2 Only

— Signal Line
 - - - N.F.B. Line

6. INTERIOR BLOCK DIAGRAM OF IC

- M5218L (Audio PRE Amp. IC) <A-707/A-505>

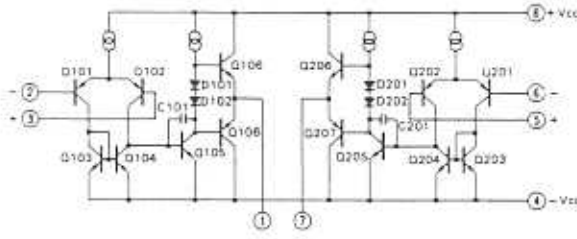
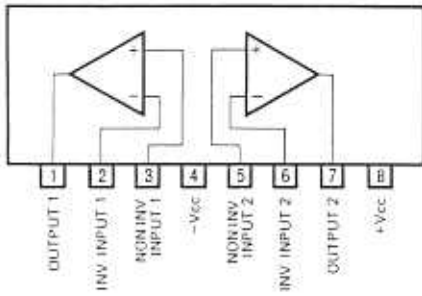

- STK4843 (AF Power Amp. IC) <A-505>

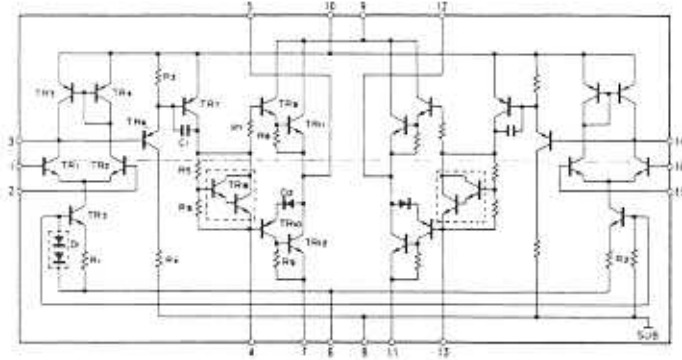

- STK3041 (Driver Amplifier IC) <A-707>

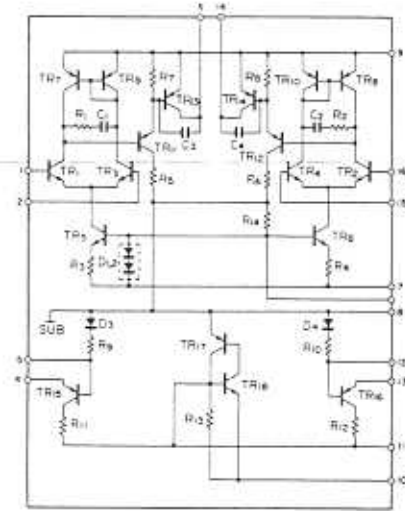

- STK2250 (AF Power Amp. Output Stage IC) <A-707>

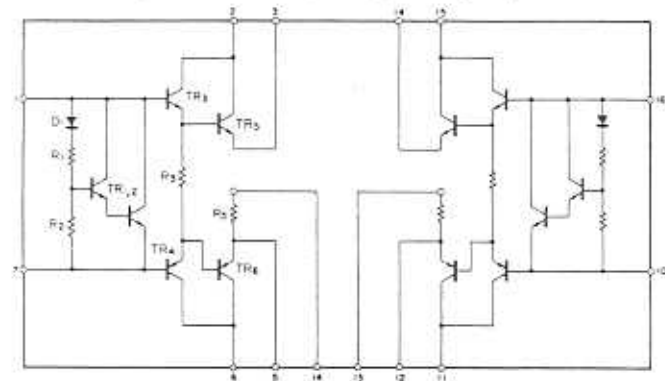

7. REPLACEMENT OF SIDE PANEL L(R)

1. Remove bonnet and bottom plate.
2. Remove the screw (5x) fixing side panel L (R) from rear panel side.
3. Shift the position of the side panel L (R) 2 cm in the arrow direction ① and then pull it the arrow direction ② to remove the side panel L (R). (See Fig. 7-1)

Fig. 7-1

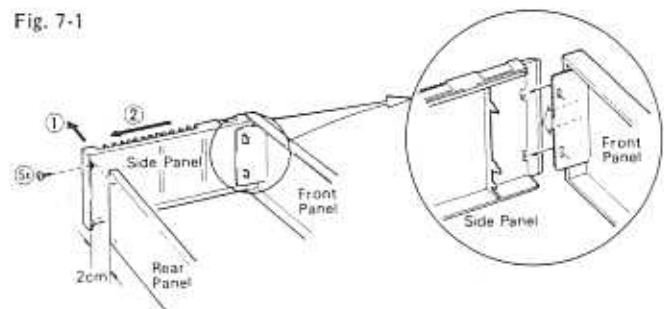

8. PACKING LIST

Parts No.	Stock No.	Description
1	91263810	Vinyl Cover
2	07949000	Styrofoam Packing
3	07948400	Carton Case <A-707/Silver Model>
	07948300	Carton Case <A-707/Black Model>
	07948700	Carton Case <A-505/Silver Model>
	07948600	Carton Case <A-505/Black Model>

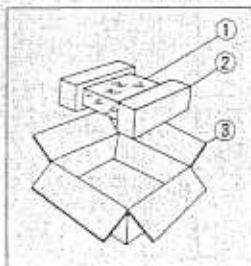

9. ACCESSORY LIST

Stock No.	Description
46355600	Operating Instruction <A-707>
46354700	Operating Instruction <A-505>

SANSUI ELECTRIC CO., LTD.:

SANSUI ELECTRONICS CORPORATION:

SANSUI ELECTRONICS (U.K.) LTD.
SANSUI ELECTRONICS G.M.B.H.

14-1, Izumi 2-chome, Suginami-ku, Tokyo 168 Japan
 PHONE: (03) 324-8891/TELEX: 232-2076 (International Division)
 1250 Valley Brook Ave. Lyndhurst, N.J. 07071 U.S.A.
 333 West Alondra Blvd. Gardena, California 90247 U.S.A.
 3036 Koopaka St. Honolulu, Hawaii 96819 U.S.A.
 Unit 10A, Lyon Industrial Estate, Rockware Avenue, Greenford, Middx UB6, OAA, England
 Paul Ehrlich Strasse 8, 6074 Rödermark 2, West Germany

(SM1-56)

Printed in Japan (720030M) (Stock No. 36469800)