

SERVICE MANUAL

INTEGRATED STEREO AMPLIFIER

SANSUI A-E750/E550

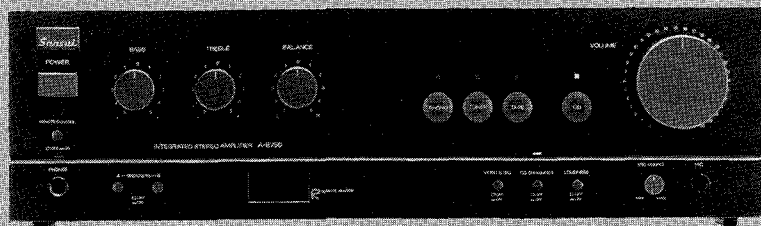

CAUTION

1. Parts identified by the Δ symbol on the schematic diagram and the parts list are critical for safety. Use only replacement parts that have critical characteristics recommended by the manufacturer.
2. Make leakage-current or resistance measurements to determine that exposed parts are acceptably insulated from the supply circuit before returning the appliance to the customer.

•SPECIFICATIONS

A-E750

Power output

Min. RMS, both channels driven, from 20 to 20,000 Hz, with no more than 0.07% total harmonic distortion.

90 watts per channel into 8 ohms.

Load impedance..... 8 ohms

Total harmonic distortion

..... less than 0.07% at or below rated min. RMS power output

Frequency response (at 1 watt)

Overall (from CD, TUNER, TAPE PLAY)

..... 10 to 60,000 Hz, +0 dB
-3.0 dB

Input sensitivity and impedance (at 1 kHz)

PHONO..... 3.2 mV/47 kohms

(Max. input capability, 120 mV at 1 kHz, less than 0.1% total harmonic distortion)

CD..... 270 mV/47 kohms

TUNER, TAPE PLAY... 200 mV/47 kohms

MIC..... 0.6 mV/10 kohms

Output level (1 kHz)

TAPE REC..... 160 mV into 47 kilohms

Signal to noise ratio (short-circuit, A-network)

PHONO..... 72 dB

CD..... 90 dB

TUNER, TAPE PLAY... 90 dB

Controls

BASS..... ± 8 dB at 50 Hz

TREBLE..... ± 8 dB at 10 kHz

LOUDNESS..... +8 dB at 50 Hz

(VOLUME: -30 dB position) +6 dB at 10 kHz

CD OPTIMIZER..... +2.5 dB at 100 Hz

Power requirements

Power voltage..... 120/220/240V (50/60 Hz)

For U.S.A & Canada

..... 120V (60 Hz)

Power consumption... 300 watts 390 VA Rated

450 watts Maximum

Dimensions..... 380 mm (15") W

111 mm (4-3/8") H

298 mm (11-3/4") D

Weight..... 7.1 kg (15.7 lbs) net

8.2 kg (18.1 lbs) packed

to be continued ▶

Sansui

SANSUI ELECTRIC CO., LTD.

A-E550

Power output

Min. RMS, both channels driven, from 20 to 20,000 Hz, with no more than 0.1% total harmonic distortion.

55 watts per channel into 8 ohms.

Load impedance..... 8 ohms

Total harmonic distortion

..... less than 0.08% at or below rated min. RMS power output

Frequency response (at 1 watt)

Overall (from CD, TUNER, TAPE PLAY)

..... 10 to 60,000 Hz, +0 dB
-3.0 dB

Input sensitivity and impedance (at 1 kHz)

PHONO..... 3.2 mV/47 kohms
(Max. input capability; 120 mV at 1 kHz, less than 0.08% total harmonic distortion)

CD..... 270 mV/47 kohms

TUNER, TAPE PLAY..... 200 mV/47 kohms

MIC..... 0.6 mV/10 kohms

Output level (1 kHz)

TAPE REC..... 160 mV into 47 kilohms

Signal to noise ratio (short-circuit, A-network)

PHONO..... 72 dB

CD..... 90 dB

TUNER, TAPE PLAY..... 90 dB

Controls

BASS..... ±8 dB at 50 Hz

TREBLE..... ±8 dB at 10 kHz

LOUDNESS..... +8 dB at 50 Hz

(VOLUME: -30 dB position) +6 dB at 10 kHz

CD OPTIMIZER..... +2.5 dB at 100 Hz

Power requirements

Power voltage..... 120/220/240V (50/60 Hz)

For U.S.A & Canada

..... 120V (60 Hz)

Power consumption..... 200 watts 250 VA Rated

280 watts Maximum

Dimensions..... 380 mm (15") W

111 mm (4-3/8") H

298 mm (11-3/4") D

Weight..... 5.5 kg (12.1 lbs) net

6.6 kg (14.6 lbs) packed

* Design and specifications subject to changes without notice for improvements.

* Due to local laws and regulations, this unit sold in some areas are not equipped with variable voltage selectors.

CAUTION

1. The symbols, UL, CSA, SA, BS, UK, EU, AS, SEV and XX (EXPORT) on the parts list and the schematic diagram mean followings respectively.

UL..... Manufactured for U.S.A market.
(Underwriters Laboratories approved model.)

CSA..... Manufactured for Canadian market.

SA..... Manufactured for South African market.

BS, UK..... Manufactured for United Kingdom market.

EU..... Manufactured for European market.

AS..... Manufactured for Australian market.

SEV..... Manufactured for Swiss market.

XX (EXPORT).. Standard Version.

NON MARK.... Common Parts.

2. Some printed circuit boards are not supplied as the assembled.

To separate these in this service manual, the stock No's are not indicated at the ends of the board names. However, the individual parts on the circuit boards are provided by orders.

3. Since some of capacitors and resistors are omitted from parts lists in this service manual, refer to the Common Parts List for capacitors & resistors, which was issued on February 1983.

4. Abbreviations in this service manual are as follows.

•Abbreviations List

- C.R. : Carbon Resistor
- S.R. : Solid Resistor
- Ce.R. : Cement Resistor
- M.R. : Metal Film Resistor
- F.R. : Fusing Resistor
- N.I.R. : Non-Inflammable Resistor
- A.R. : Array Resistor
- C.C. : Ceramic Capacitor
- C.T. : Ceramic Capacitor, Temperature Compensation
- E.C. : Electrolytic Capacitor
- E.L. : Low Leak Electrolytic Capacitor
- E.B. : Bi-Polar Electrolytic Capacitor
- E.B.L. : Low Leak Bi-Polar Electrolytic Capacitor
- Ta.C. : Tantalum Capacitor
- F.C. : Film Capacitor
- M.P. : Metalized Paper Capacitor
- P.C. : Polystyrene Capacitor
- G.C. : Gimmic Capacitor
- A.C. : Array Capacitor
- V.R. : Variable Resistor
- S.V.R. : Semi Variable Resistor
- SW. : Switch
- Chip R. : Chip Resistor
- Chip C. : Chip Capacitor

1. BLOCK DIAGRAM

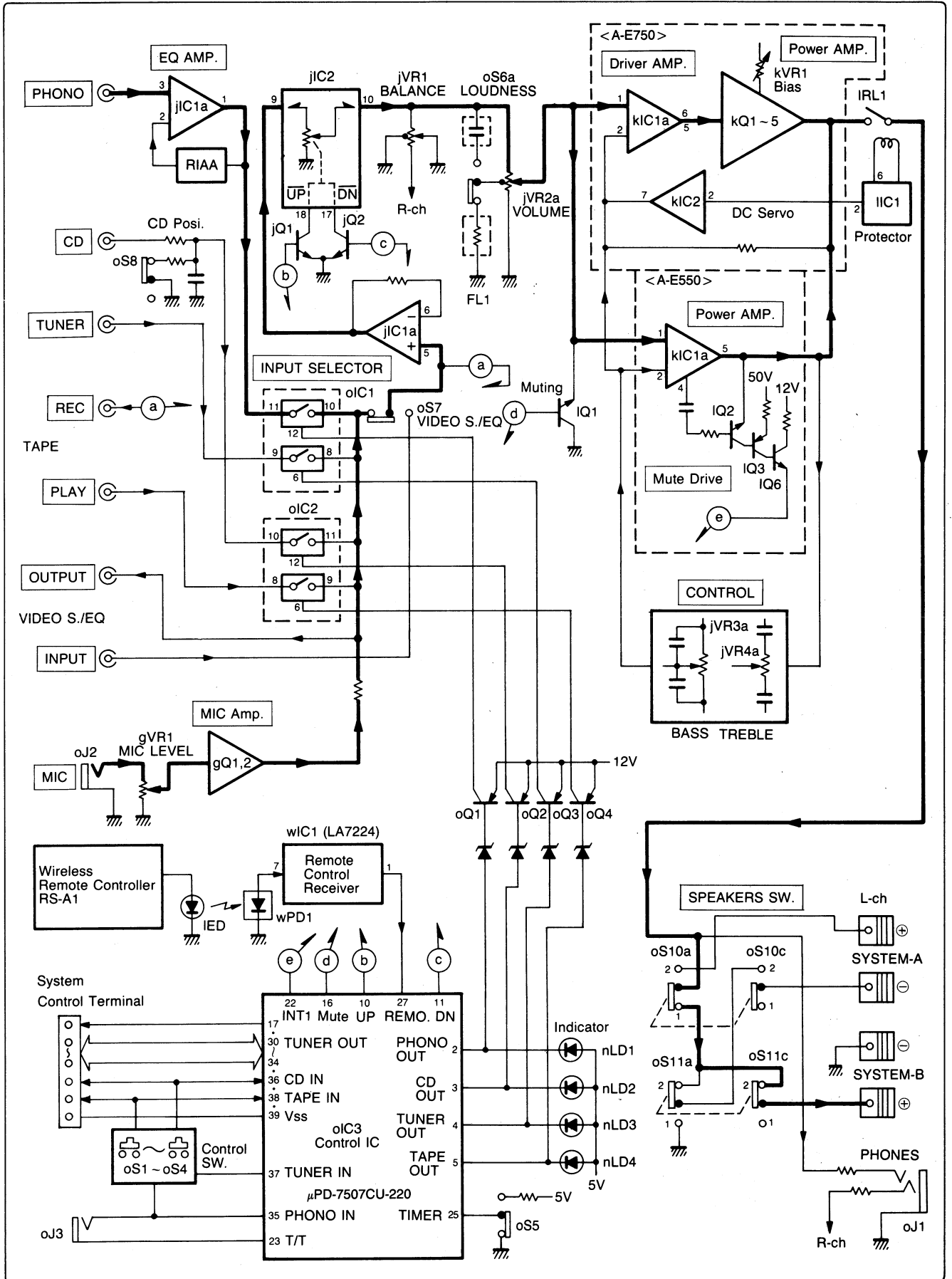

2. PARTS LOCATION & PARTS LIST

2-1. F-4759 EQ. Amp. Board (Stock No. 00976701)

Component Side

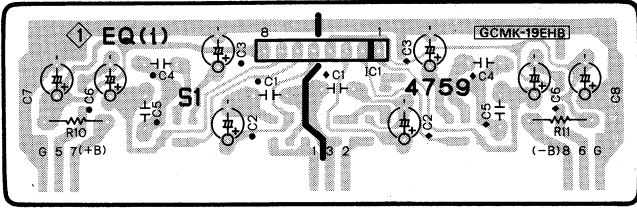

Parts List

Parts No.	Stock No.	Description
•IC		
iIC1	46078900	M5218L
iJW1	46741100	Cross Conductor (Chip)
iJW2	46741100	Cross Conductor (Chip)
iJW3	46741100	Cross Conductor (Chip)
iR1	46752400	100kΩ 1/8W Chip R.
iR2	46746800	470Ω 1/8W Chip R.
iR3	46752400	100kΩ 1/8W Chip R.
iR4	46746900	510Ω 1/8W Chip R.
iR5	46746900	510Ω 1/8W Chip R.

Pattern Side <Chip Parts>

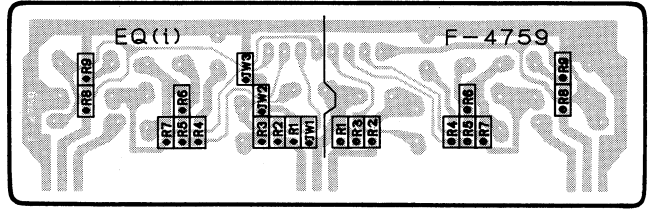

Parts No.	Stock No.	Description
iR6	46750800	22kΩ 1/8W Chip R.
iR7	46753500	300kΩ 1/8W Chip R.
iR8	46746800	470Ω 1/8W Chip R.
iR9	46752400	100kΩ 1/8W Chip R.
△iR10	46229000	100Ω 1/2W N.I.R.
△iR11	46229000	100Ω 1/2W N.I.R.
iR12	46752400	100kΩ 1/8W Chip R.
iC2	46283700	0.047μF 50V F.C.
iC4	46282400	3300pF 50V F.C.
iC5	46283000	0.012μF 50V F.C.

2-2. F-4761 Tone Control Board

Component Side

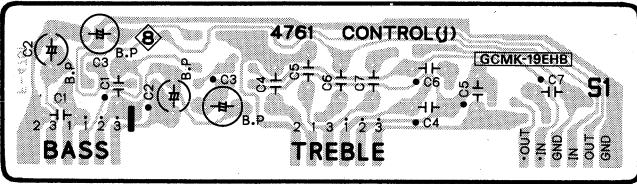

Parts List

Parts No.	Stock No.	Description
jJW1	46741100	Cross Conductor (Chip)
jJW2	46741100	Cross Conductor (Chip)
jR1	46750200	12kΩ 1/8W Chip R.
jR2	46748200	1.8kΩ 1/8W Chip R.
jR3	46753400	270kΩ 1/8W Chip R.
jR4	46751000	27kΩ 1/8W Chip R.
jR5	46751700	51kΩ 1/8W Chip R.
jR6	46748400	2.2kΩ 1/8W Chip R.
jR7	46749400	5.6kΩ 1/8W Chip R.

Pattern Side <Chip Parts>

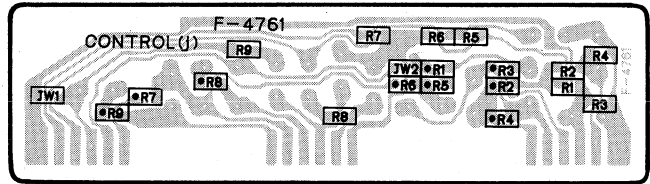

Parts No.	Stock No.	Description
jR8	46749600	6.8kΩ 1/8W Chip R.
jR9	46747200	680Ω 1/8W Chip R.
jC1	46283600	0.039μF 50V F.C.
jC2	46937000	0.22μF 50V E.B.
jC3	48101500	100μF 6.3V E.B.
jC4	46281800	1000pF 50V F.C.
jC5	46282800	8200pF 50V F.C.
jC6	46282700	6800pF 50V F.C.

2-3. F-4765 Protector Board (Stock No. 00980101 = A-E750/Stock No. 00931701 = A-E550)

Component Side

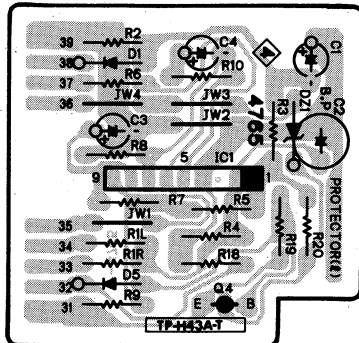

Parts List

Parts No.	Stock No.	Description
•Transistor		
IQ4	46367001	2SA1115 (A-E750)
	or 46367201	2SA1048 (A-E750)
•IC		
iIC1	46207600	TA7317P
•Diode		
ID1	03117600	1S2473T77
	or 46086000	1S1588TP-3
ID5	03117600	1S2473T77 (A-E750)
	or 46086000	1S1588TP-3 (A-E750)
•Zener Diode		
IDZ1	46115400	05Z20-Y (A-E750)
IC2	48101500	100μF 6.3V E.B.

2-4. F-4762 Driver Amp. Board <A-E750> (Stock No. 00979901)

Component Side

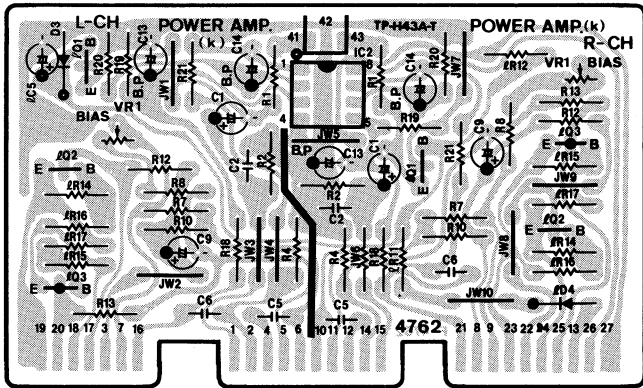

Parts List

Parts No.	Stock No.	Description
•IC		
KIC2	03607700	NJM4558D
△kR12	46228600	47Ω 1/2W N.I.R.
△kR13	46228600	47Ω 1/2W N.I.R.

Parts No.	Stock No.	Description
kC13	48103500	2.2μF 50V E.B.
kC14	48102400	4.7μF 25V E.B.
kVR1	07261600	1kΩ (B) S.V.R., Bias adj.
•Transistor		
IQ1	46367301	2SC2458
	or 46581701	2SC1845
IQ2	46367101	2SC2603
	or 46367301	2SC2458
IQ3	46367001	2SA1115
	or 46367201	2SA1048
•Diode		
ID3	03117600	1S2473T77
	or 46086000	1S1588TP-3
ID4	03117600	1S2473T77
	or 46086000	1S1588TP-3
△IR14	46229000	100Ω 1/2W N.I.R.
△IR15	46229000	100Ω 1/2W N.I.R.
△IR16	46230000	680Ω 1/2W N.I.R.
△IR17	46230000	680Ω 1/2W N.I.R.

2-5. F-5228 Power SW. Board <A-E550> (Stock No. 00932401 = XX/Stock No. 00932402 = UL) (Stock No. 00932405 = EU•BS

Component Side

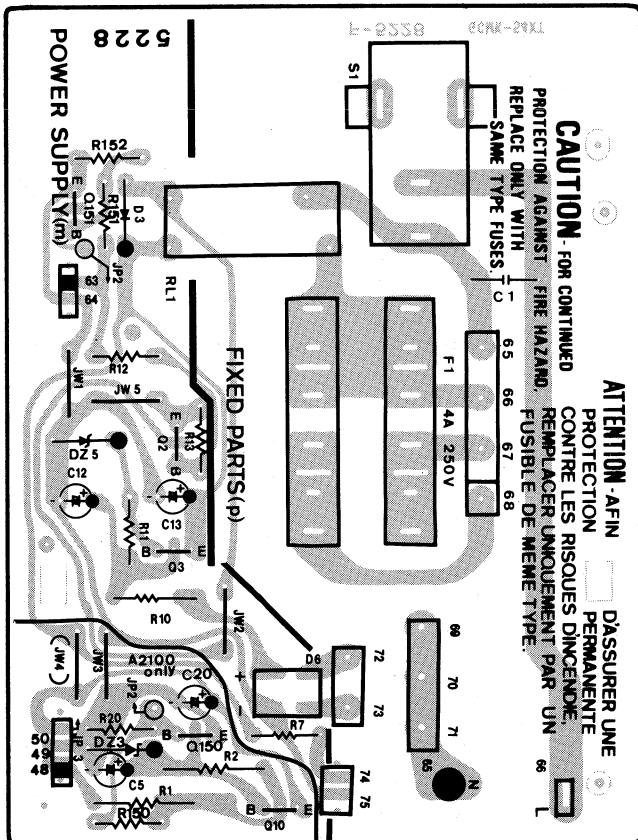

/Stock No. 00932409 = SEV)

Parts No.	Stock No.	Description
•Transistor		
mQ2	07194801	2SC1815
	or 07299701	2SC2603
	or 46078801	2SC2458
mQ3	03083901	2SD313HP (XX)
	46546701	2SD880 (XX)
	48073601	2SD1061 (XX)
	48369801	2SC1826 (XX)
	48059501	2SC3244 (UL•EU•BS•SEV)
mQ10	03083901	2SD313HP
	or 48369801	2SC1826
•Diode		
mD3	48123600	11E2
△mD6	46273600	DBB10B
•Zener Diode		
mDZ3	46116000	05Z24-Y
	or 46116100	05Z24-Z
mDZ5	03150601	EQB01-12 (XX)
	03170300	RD12F (XX)
	46113800	05Z12X (UL•EU•BS•SEV)
	46113900	05Z12Y (UL•EU•BS•SEV)
△mR1	46625100	470Ω 2W N.I.R.
△mR11	46625000	390Ω 2W N.I.R. (XX)
mRL1	48340200	Relay
	or 48340300	Relay
△pC1	46371700	4700pF 400V C.C.
△	or 48186600	4700pF 400V C.C.
△pF1	48266800	AC Fuse 2.0A 250V (XX)
△	48267200	AC Fuse 4.0A 250V (UL)
△	07185000	AC Fuse 2A 250V (EU•BS)
△	07184900	AC Fuse 1.6A 250V (SEV)
△pF2	48266800	AC Fuse 2.0A 250V (XX)
△	07184600	Fuse 0.8A 250V (SEV)
△pS1	46364300	Push SW., POWER

2-6. F-5121 Power Amp. & Power Supply Board <A-E750> (Stock No. 00980001)

Component Side

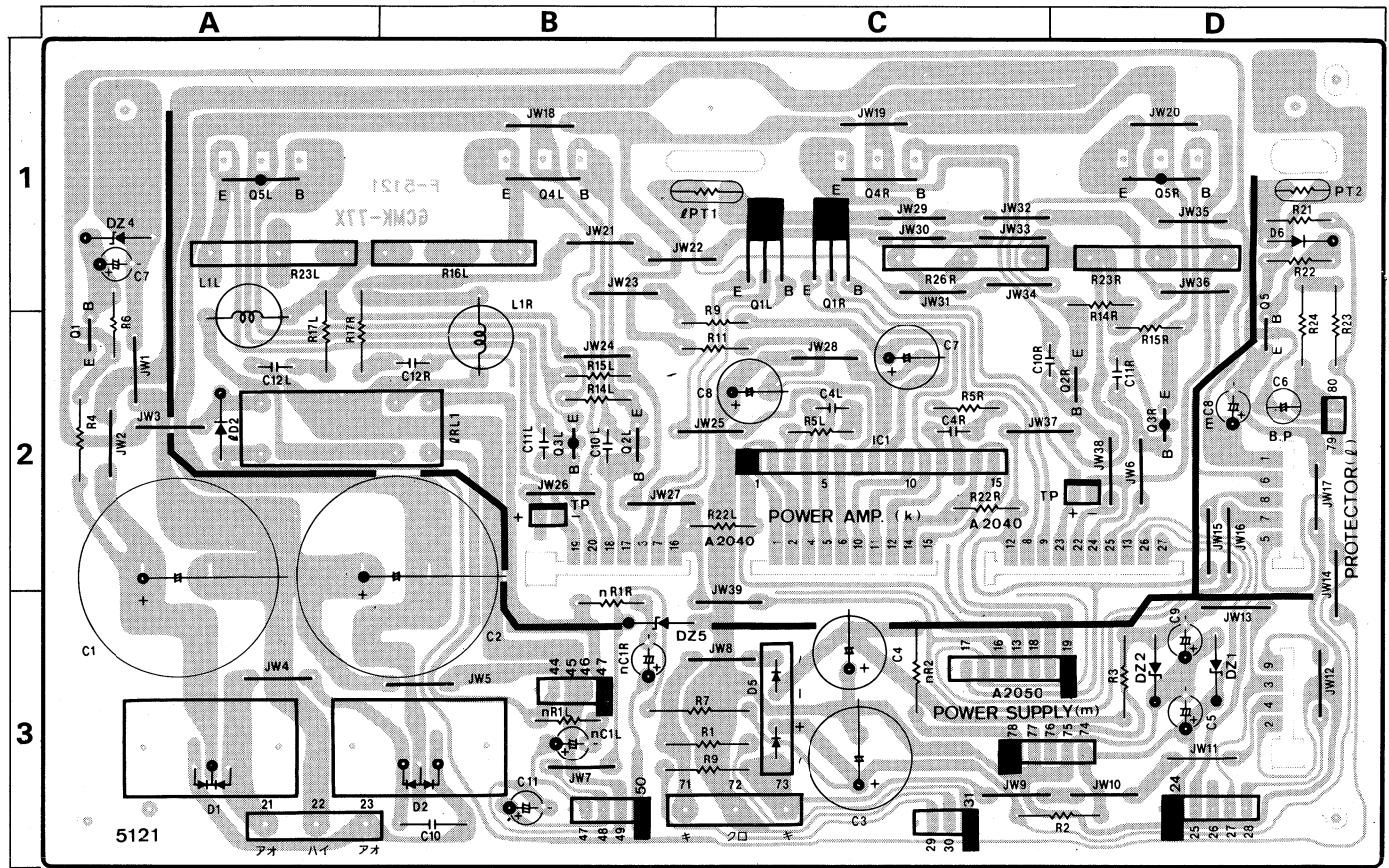

Parts List

Parts No.	Stock No.	Description	Position
•Transistor			
△kQ1	03067401	2SC1845	1C
△kQ2	46728901	2SC3298	2B,2D
△	or 48158701	2SC2591	2B,2D
△kQ3	46728801	2SA1306	2B,2D
△	or 48158601	2SA1111	2B,2D
△kQ4	46085301	2SC2581	1B,1C
△	or 48490801	2SC3855	1B,1C
△kQ5	46085401	2SA1106	1A,1D
△	or 48490701	2SA1491	1A,1D
•IC			
KIC1	46862200	STK3102-2A	2C
△kR9	46228400	33Ω 1/2W N.I.R.	2C
△kR11	46228400	33Ω 1/2W N.I.R.	2C
△kR14	46229200	150Ω 1/2W N.I.R.	2B,1D
△kR15	46229200	150Ω 1/2W N.I.R.	2B,2D
△kR16	46184100	0.22ΩX2 5W Ce.R.	1B,1C
△kR17	46248100	10Ω 1W N.I.R.	2A
△kR23	46184100	0.22ΩX2 5W Ce.R.	1A,1D
KC7	46312800	47μF 100V E.C.	2C
KC8	46312800	47μF 100V E.C.	2C
KC12	46283700	0.047μF 50V F.C.	2A,2B
KL1	46851901	Filter Coil 0.82μH	2A,2B
•Transistor			
IQ5	48061801	2SC3244	2D
•Diode			
ID2	48123600	11E2	2A
ID6	03117600	1S2473T77	1D
	or 46086000	1S1588TP-3	1D
IPT1	48484100	Thermistor	1B
△IPT2	48262700	Thermistor	1D

Parts No.	Stock No.	Description	Position
△IR23	46249300	100Ω 1W N.I.R.	2D
△IR24	46249300	100Ω 1W N.I.R.	2D
IC6	48103600	3.3μF 50V E.B.	2D
IRL1	48183100	Relay	2A
	or 48183200	Relay	2A
•Transistor			
mQ1	03083901	2SD313HP	2A
	or 46546701	2SD880	2A
	or 48073601	2SD1061	2A
	or 48369801	2SC1826	2A
•Diode			
△mD1	48159900	CTM-22S	3A
△mD2	48159800	CTM-22R	3B
△mD5	03117000	RB152-LFF	3C
•Zener Diode			
mDZ1	03150601	EQB01-12	3D
	or 03170300	RD12F	3D
mDZ2	03150601	EQB01-12	3D
	or 03170300	RD12F	3D
mDZ4	46116000	05Z24-Y	1A
	or 46116100	05Z24-Z	1A
△mR2	46624500	150Ω 2W N.I.R.	3D
△mR3	46249600	180Ω 1W N.I.R.	3D
△mR4	46250300	680Ω 1W N.I.R.	2A
△mR6	46230700	2.7kΩ 1/2W N.I.R.	2A
△mR31	46623100	10Ω 2W N.I.R.	
mC1	48201400	8200μF 80V E.C.	2A
mC2	48201400	8200μF 80V E.C.	2B
mC10	08680400	0.01μF 500V C.C.	3B

2-7. F-5225 IC of Control Board (Stock No. 00980401 = A-E750/Stock No. 00932001 = A-E550)

Component Side

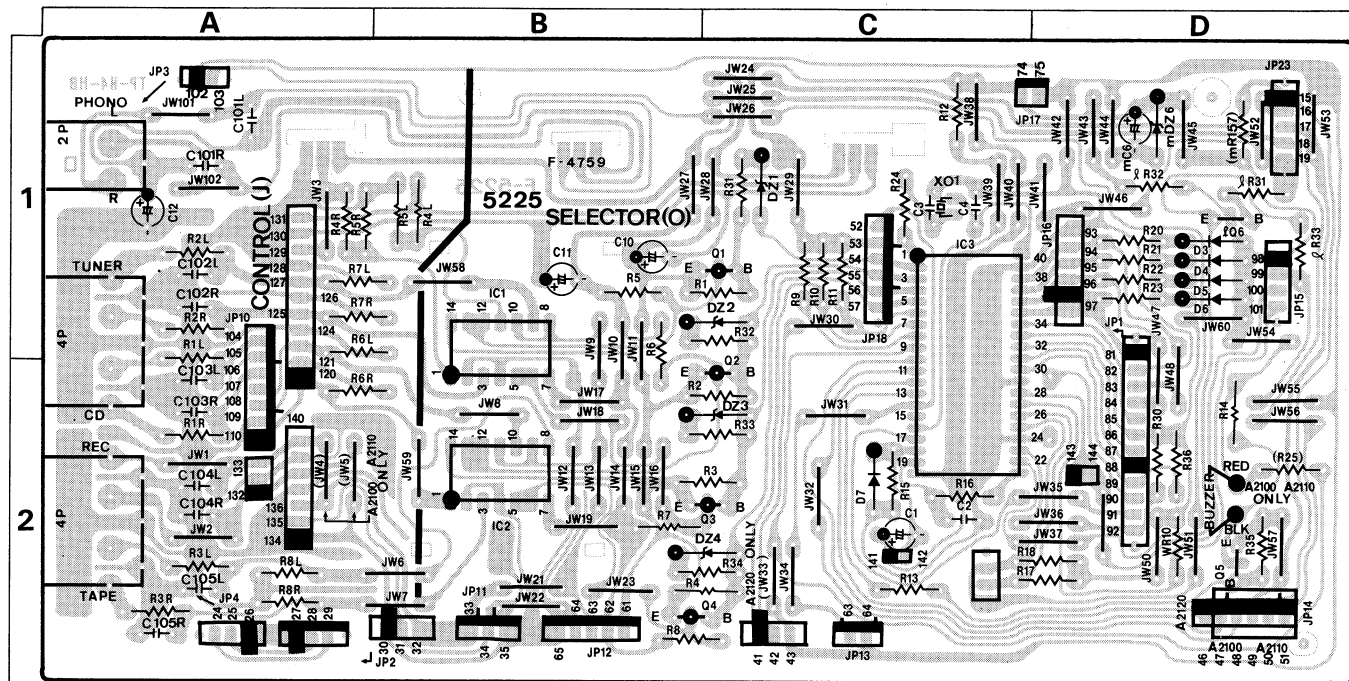

Parts List

Parts No.	Stock No.	Description	Position	Parts No.	Stock No.	Description	Position
IC200	46282500	3900pF 50V F.C.		oIC2	46255000	LC4066BH	2B
• Transistor				or 48056800		LC4966	2B
IO6	46367101	2SC2603	1D	48316710		μPD7507CU-220	1C
	or 46367301	2SC2458	1D	oXO1	48339400	Quartz Crystal KF38G	1C
	or 46391901	2SC2785	1D	• Diode			
• Zener Diode				oD3	03117600	1S2473T77	1D
mDZ6	46111100	05Z5.1-X	1D	or 46086000		1S1588TP-3	1D
	or 46824300	RD4.7E-B1	1D	oD4	03117600	1S2473T77	1D
• Transistor				or 46086000		1S1588TP-3	1D
oQ1	46188601	2SA1015	1C	oD5	03117600	1S2473T77	1D
	or 46367001	2SA1115	1C	or 46086000		1S1588TP-3	1D
	or 46367201	2SA1048	1C	oD6	03117600	1S2473T77	1D
oQ2	46188601	2SA1015	2C	or 46086000		1S1588TP-3	1D
	or 46367001	2SA1115	2C	oD7	03117600	1S2473T77	2C
	or 46367201	2SA1048	2C	or 46086000		1S1588TP-3	2C
oQ3	46188601	2SA1015	2C	oD10	03117600	1S2473T77	2D
	or 46367001	2SA1115	2C	or 46086000		1S1588TP-3	2D
	or 46367201	2SA1048	2C	• Zener Diode			
oQ4	46188601	2SA1015	2B	oDZ1	46112700	05Z8.2-Y	1C
	or 46367001	2SA1115	2B	oDZ2	46112700	05Z8.2-Y	1C
	or 46367201	2SA1048	2B	oDZ3	46112700	05Z8.2-Y	2C
oQ5	46188701	2SC1815	2D	oDZ4	46112700	05Z8.2-Y	2C
	or 46367101	2SC2603	2D	oZ1	07244900	Buzzer (PKM12-4A2)	2D
	or 46367301	2SC2458	2D	oZ4	46363700	2P Terminal, PHONO	1A
• IC				oZ5	46371500	4P Terminal, TUNER·CD	1A
oIC1	46255000	LC4066BH	1B	oZ6	46371500	4P Terminal, TAPE	2A
	or 48056800	LC4966	1B				

2-8. F-5226 System Control Terminal Board

Component Side

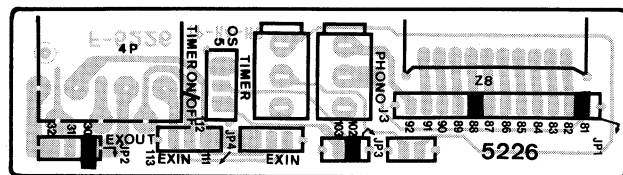

Parts List

Parts No.	Stock No.	Description
oS5	46606000	Push SW., TIMER
oJ3	46148200	Jack, Remote Control (Player)
oZ8	48313900	ST Socket (10 Pin)
oZ7	46371500	4P Terminal, VIDEO SOUND

2-9. F-5229 SPEAKERS SW. Board <A-E550>

Component Side

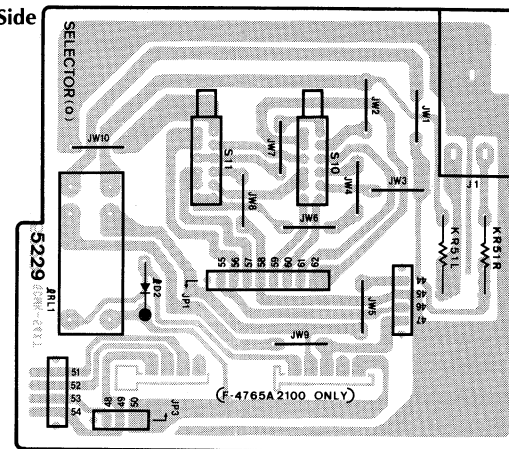

2-10. F-5230 SPEAKERS Terminal Board <A-E550>

Component Side

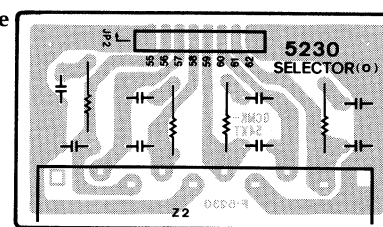

2-11. F-5244 Remote Control Receiver Board (Stock No. 00980201 = A-E750/Stock No. 00932701 = A-E550)

Component Side

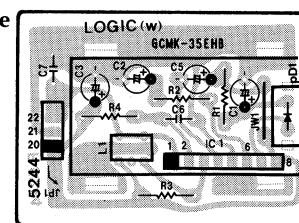

2-12. F-5268 Protector Board <A-E550> (Stock No. 00931401)

Component Side

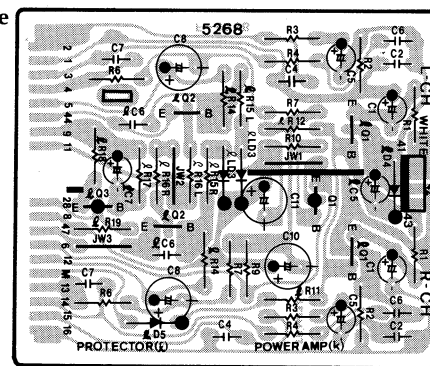

Parts List

Parts No.	Stock No.	Description
• Transistor		
kQ1	46581601	2SA992
	or 46614001	2SA1283
	or 46947301	2SA1049

Parts List

Parts No.	Stock No.	Description
ΔKR51	46229400	220Ω 1/2W N.I.R.
• Diode		
ID2	48123600	11E2
IRL1	48183100	Relay
	or 48183200	Relay
oS10	46941800	Push SW., SPEAKERS-A
oS11	46941800	Push SW., SPEAKERS-B
oJ1	46265700	Jack, PHONES

Parts List

Parts No.	Stock No.	Description
oZ2	46947500	8P Terminal, SPEAKERS

Parts List

Parts No.	Stock No.	Description
• IC		
wIC1	48159100	LA7224
wPD1	48268800	Photo Diode (PD49PI)
wL1	48179100	Coil (38kHz)

Parts No.	Stock No.	Description
IQ1	46367101	2SC2603
	or 46367301	2SC2458
	or 46391901	2SC2785
IQ2	46367101	2SC2603
	or 46367301	2SC2458
	or 46391901	2SC2785
IQ3	46581601	2SA992
	or 46614001	2SA1283
	or 46947301	2SA1049
• Diode		
ID3	03117600	1S2473T77
	or 46086000	1S1588TP-3
ID4	03117600	1S2473T77
	or 46086000	1S1588TP-3
ID5	03117600	1S2473T77
	or 46086000	1S1588TP-3
IC6	46284100	0.1μF 50V F.C.

2-13. F-5245 Selector SW. & Control Amp. Board (Stock No. 00980301 = A-E750/Stock No. 00980301 = A-E550)

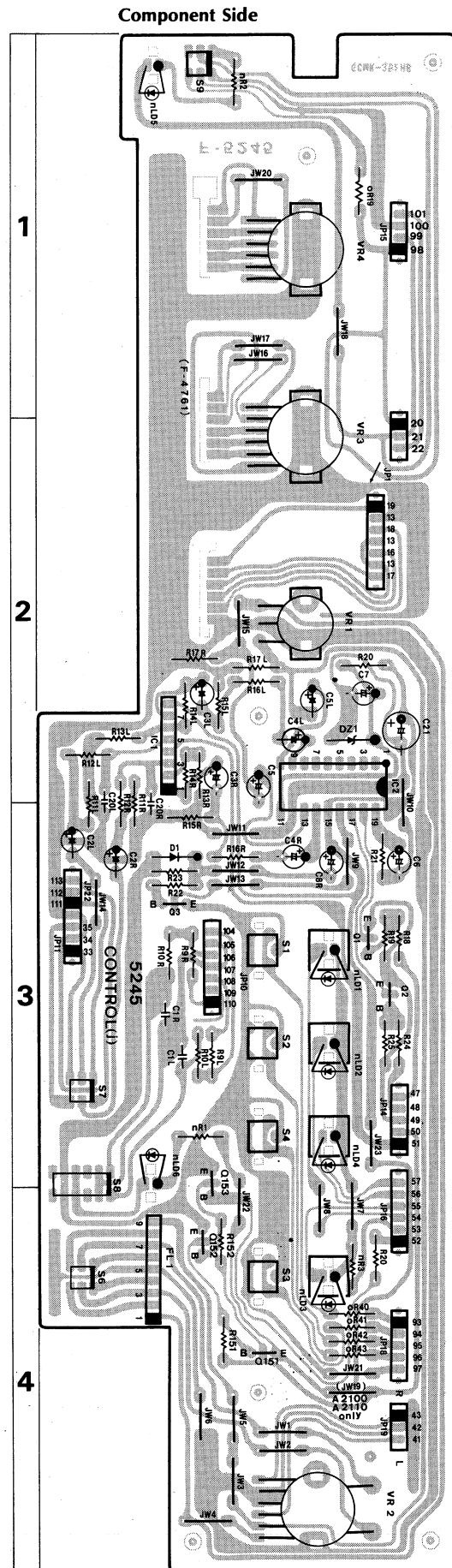

Component Side

Parts No.	Stock No.	Description	Position
•Transistor			
jQ1	46188701 or 46367101 or 46367301	2SC1815 2SC2603 2SC2458	3 3 3
jQ2	46188701 or 46367101 or 46367301	2SC1815 2SC2603 2SC2458	3 3 3
jQ3	46188701 or 46367101 or 46367301	2SC1815 2SC2603 2SC2458	3 3 3
•IC			
jIC1	46078900	M5218L	2
jIC2	46671600	LC7530	2
•Diode			
jD1	03117600 or 46086000	1S2473T77 1S1588TP-3	3 3
•Zener Diode			
jDZ1	46111800 or 46825200	05Z6.2-Y RD6.2E-B1	2 2
jC1	46282600	4700pF 50V F.C.	3
jFL1	48172000	CR Module	4
jVR1	48318500	250kΩ V.R., BALANCE	2
jVR2	48349400	150kΩ (B) V.R., VOLUME	4
jVR3	48318600	50kΩ (C) V.R., BASS	2
jVR4	48318600	50kΩ (C) V.R., TREBLE	1
•LED			
nLD1	46176900	TLS-123	3
nLD2	46176900	TLS-123	3
nLD3	46176900	TLS-123	4
nLD4	46176900	TLS-123	3
nLD5	03193700	SEL1110S	1
nLD6	03193700	SEL1110S	3
oS1	48306900	Push SW., PHONO	3
oS2	48306900	Push SW., TUNER	3
oS3	48306900	Push SW., CD	4
oS4	48306900	Push SW., TAPE	3
oS6	48313700	Push SW., LOUDNESS	4
oS7	48313700	Push SW., VIDEO/EQ	3
oS8	48319100	Push SW., CD POSITION	3
oS9	48313700	Push SW., REMOTE CONTROL 1	1

2-14. F-5267 Mic Amp. Board (Stock No. 00931601)

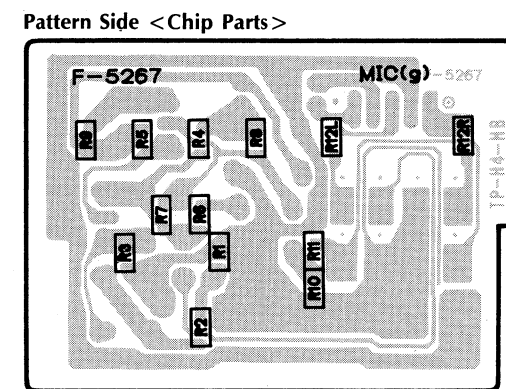
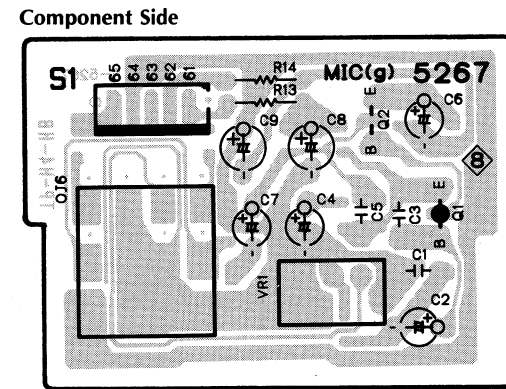

Component Side

Pattern Side <Chip Parts>

Parts No.	Stock No.	Description
•Transistor		
gQ1	46581601	2SA992
gQ2	46188701 or 46367101 or 46577801	2SC1815 2SC2603 2SC2320L
gR1	46751600	47kΩ 1/8W Chip R.
gR2	46746800	470Ω 1/8W Chip R.
gR3	46752600	120kΩ 1/8W Chip R.
gR4	46753000	180kΩ 1/8W Chip R.
gR5	46752000	68kΩ 1/8W Chip R.
gR6	46744600	56Ω 1/8W Chip R.
gR7	46751000	27kΩ 1/8W Chip R.
gR8	46749200	4.7kΩ 1/8W Chip R.
gR9	46747800	1.2kΩ 1/8W Chip R.
gR10	46752400	100kΩ 1/8W Chip R.
gR11	46746800	470Ω 1/8W Chip R.
gR12	46749800	8.2kΩ 1/8W Chip R.
gR13	46229000	100Ω 1/2W N.I.R.
gVR1	48318700	20kΩ V.R., MIC MIXING
oJ2	46365100	Jack, MIC

2-15. F-5269 Power Amp. & Power Supply Board <A-E550> (Stock No. 00931501)

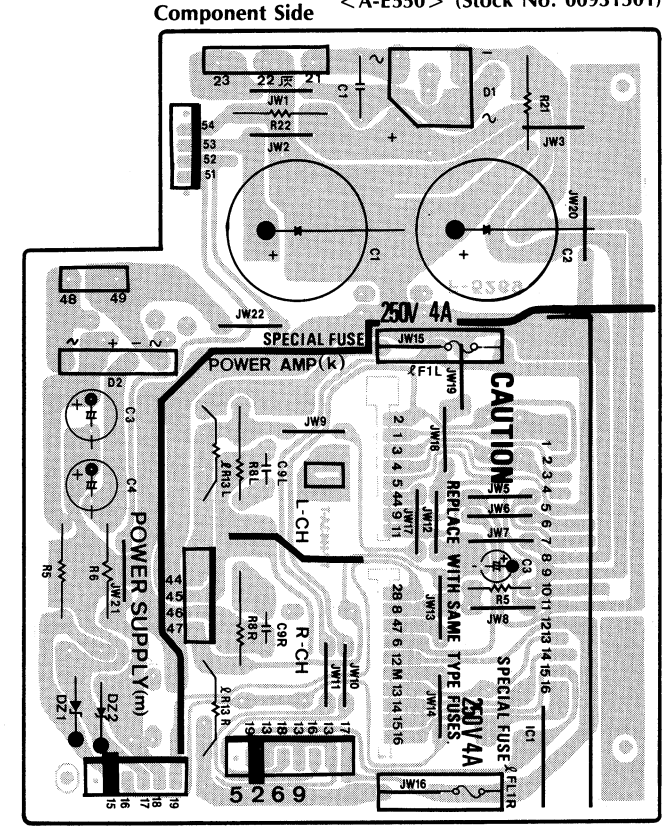

Component Side

Parts No.	Stock No.	Description
•IC		
kIC1	48065400	STK4913
kC9	46283700	0.047μF 50V F.C.
IR13	46621100	0.22Ω 2W N.I.R.
•Diode		
mD1	46194700	RB402-LFF
mD2	48177400 or 03117000	DBA40-C RB152-LFF
•Zener Diode		
mDZ1	46113800 or 46113900	05Z12-X 05Z12-Y
mDZ2	46113800 or 46113900	05Z12-X 05Z12-Y
mR31	46623100	10Ω 2W N.I.R.
mC1	46395200	4700μF 56V E.C.
mC2	46395200	4700μF 56V E.C.
mC8	08680400	0.01μF 500V C.C.

2-16. F-5405 Power SW. Board <A-E750>
 (Stock No. 00980601 = XX/Stock No. 00980602 = UL)
 (Stock No. 00980603 = CSA/Stock No. 00980605 = EU•BS)
 (Stock No. 00980609 = SEV)

Component Side

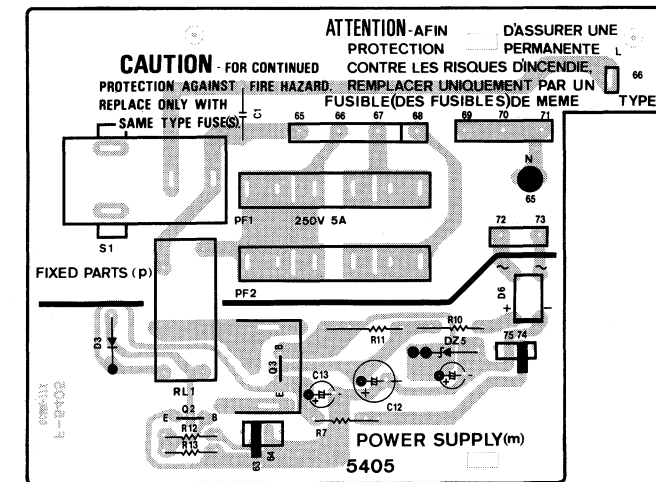

Parts List

Parts No.	Stock No.	Description
•Transistor		
mQ2	07194801	2SC1815
	or 46078801	2SC2458
mQ3	03083901	2SD313HP (XX)
	46546701	2SD880 (XX)
	48073601	2SD1061 (XX)
	48369801	2SC1826 (XX)
	48059501	2SC3244 (UL•CSA•EU•BS•SEV)
•Diode		
mD3	48123600	11E2
△mD6	46273600	DBB10B
•Zener Diode		
mDZ5	03150601	EQB01-12 (XX)
	03170300	RD12F (XX)
	46113800	05Z12X (UL•CSA•EU•BS•SEV)
	46113900	05Z12Y (UL•CSA•EU•BS•SEV)
nR11	46625000	390Ω 2W N.I.R.
mRL1	48340200	Relay
	or 48340300	Relay
△pC1	46371700	4700pF 400V C.C.
△	or 48186600	4700pF 400V C.C.
△pF1	48266900	AC Fuse 2.5A 250V (XX)
△	48267300	AC Fuse 5.0A 250V (UL•CSA)
△	07185100	AC Fuse 2.5A 250V (EU•BS•SEV)
△pF2	48266900	AC Fuse 2.5A 250V (XX)
△	07184800	Fuse 1.25A 250V (SEV)
△pS1	48113300	Push SW., POWER (XX•UL•EU•BS•SEV)
△	48065100	Push SW., POWER (CSA)

2-17. F-5406 SPEAKERS SW. Board <A-E750>

Component Side

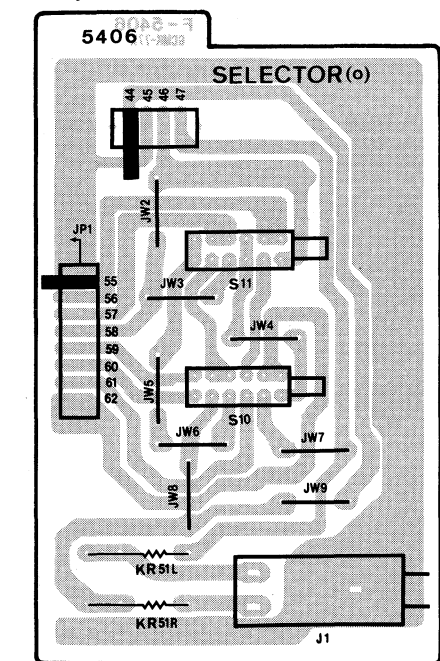

Parts List

Parts No.	Stock No.	Description
△KR51	46249700	220Ω 1W N.I.R.
oS10	46941800	Push SW., SPEAKERS-A
oS11	46941800	Push SW., SPEAKERS-B
oJ1	46265700	Jack, PHONES

2-18. F-5407 SPEAKERS Terminal Board <A-E750>

Component Side

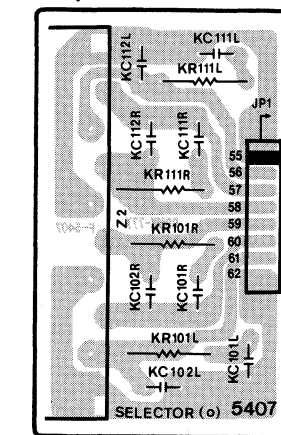

Parts List

Parts No.	Stock No.	Description
oZ2	46947500	8P Terminal, SPEAKERS

3. OTHER PARTS

3-1. Front View

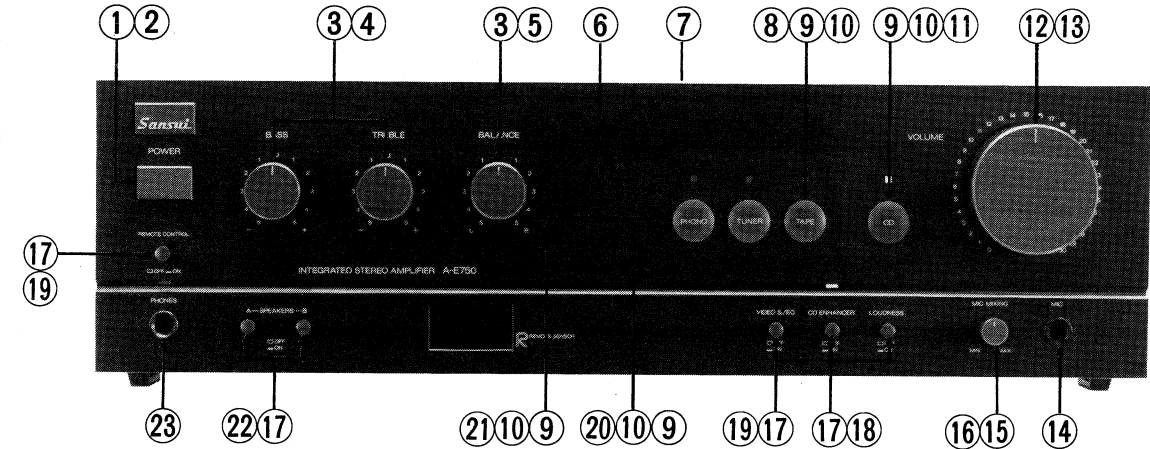

Parts List

Parts No.	Stock No.	Description
1	27039800	Knob, POWER
△ 2	48113300	Push SW., POWER for A-E750 (XX·UL·EU·BS·SEV)
△	48065100	Push SW., POWER for A-E750 (CSA)
△	46364300	Push SW., POWER for A-E550
3	27056200	Knob, BASS, TREBLE, BALANCE
4	48318600	50kΩ V.R., BASS, TREBLE
5	48318500	250kΩ V.R., BALANCE
6	27171600	Front Panel Ass'y (A-E750)
	27164200	Front Panel Ass'y (A-E550)
7	27049300	Bonnet
8	27052500	Knob, TAPE
9	48306900	Push SW., PHONO, TUNER, TAPE, CD
10	27051400	Knob, Adapter

Parts No.	Stock No.	Description
11	27052600	Knob, CD
12	27056300	Knob, VOLUME
13	48349400	150kΩ V.R., VOLUME
14	46365100	Jack, MIC
15	47636100	Knob, MIC MIXING
16	48318700	20kΩ V.R., MIC MIXING
17	27038500	Knob, LOUDNESS, CD POSITION, SPEAKERS, VIDEO S/EQ, REMORT CONTROL
18	48319100	Push SW., CD POSITION
19	48313700	Push SW., LOUDNESS, VIDEO S/EQ REMORT CONTROL
20	27052400	Knob, TUNER
21	27052300	Knob, PHONO
22	46941800	Push SW., SPEAKERS
23	46265700	Jack, PHONES

3-2. Top View

Parts List

Parts No.	Stock No.	Description
△ 1	15025501	Small Power Transformer for A-E750 (XX)
△	15025502	Small Power Transformer for A-E750 (UL·CSA)
△	15025505	Small Power Transformer for A-E750 (EU·BS·SEV)
△	15025301	Small Power Transformer for A-E550 (XX)
△	15025302	Small Power Transformer for A-E550 (UL)
△	15025305	Small Power Transformer for A-E550 (EU·BS·SEV)
2	27055000	Side Panel Ass'y (Left)
△ 3	15025409	Large Power Transformer with voltage selector socket for A-E750 (XX)
△	15025402	Large Power Transformer for A-E750 (UL·CSA)
△	15025405	Large Power Transformer for A-E750 (EU·BS·SEV)
△	15024109	Large Power Transformer with voltage selector socket for A-E550 (XX)
△	15024102	Large Power Transformer for A-E550 (UL)
△	15024105	Large Power Transformer for A-E550 (EU·BS·SEV)
4	47157300	AC Cord Cover

Parts No.	Stock No.	Description
△ 5	38004700	Power Supply Cord (XX·UL)
△	48187500	Power Supply Cord for A-E750 (CSA)
△	46128900	Power Supply Cord for A-E750 (EU)
△	48306700	Power Supply Cord for A-E750 (SEV)
△	38004500	Power Supply Cord for A-E550 (EU·SEV)
△	38004300	Power Supply Cord (BS)
6	46947500	8P Terminal, SPEAKERS
△ 7	48175200	Plug, voltage selector (XX)
△	07204700	Slide SW., voltage selector (EU·BS)
△ 8	46365000	AC Outlet (XX·UL)
△	48184400	AC Outlet for A-E750 (CSA)
△	46161000	AC Outlet (EU·SEV)
△	46364800	AC Outlet (BS)
9	07255000	Fan <A-E750>
10	47878000	Spacer <A-E750>
11	47808100	Motor Holder <A-E750>
△ 12	46737500	DC Motor <A-E750>
13	47808000	Motor Cover <A-E750>
14	48313900	ST Socket (10 Pin)
15	46148200	Mini Jack, player control
16	46606000	Push SW., TIMER
17	46371500	4P Terminal, VIDEO S./EQ
18	22301510	GND Terminal
19	46363700	2P Terminal, PLAYER
20	46371500	4P Terminal, TUNER, CD, TAPE
21	27055100	Side Panel Ass'y (Right)

<A-E750>

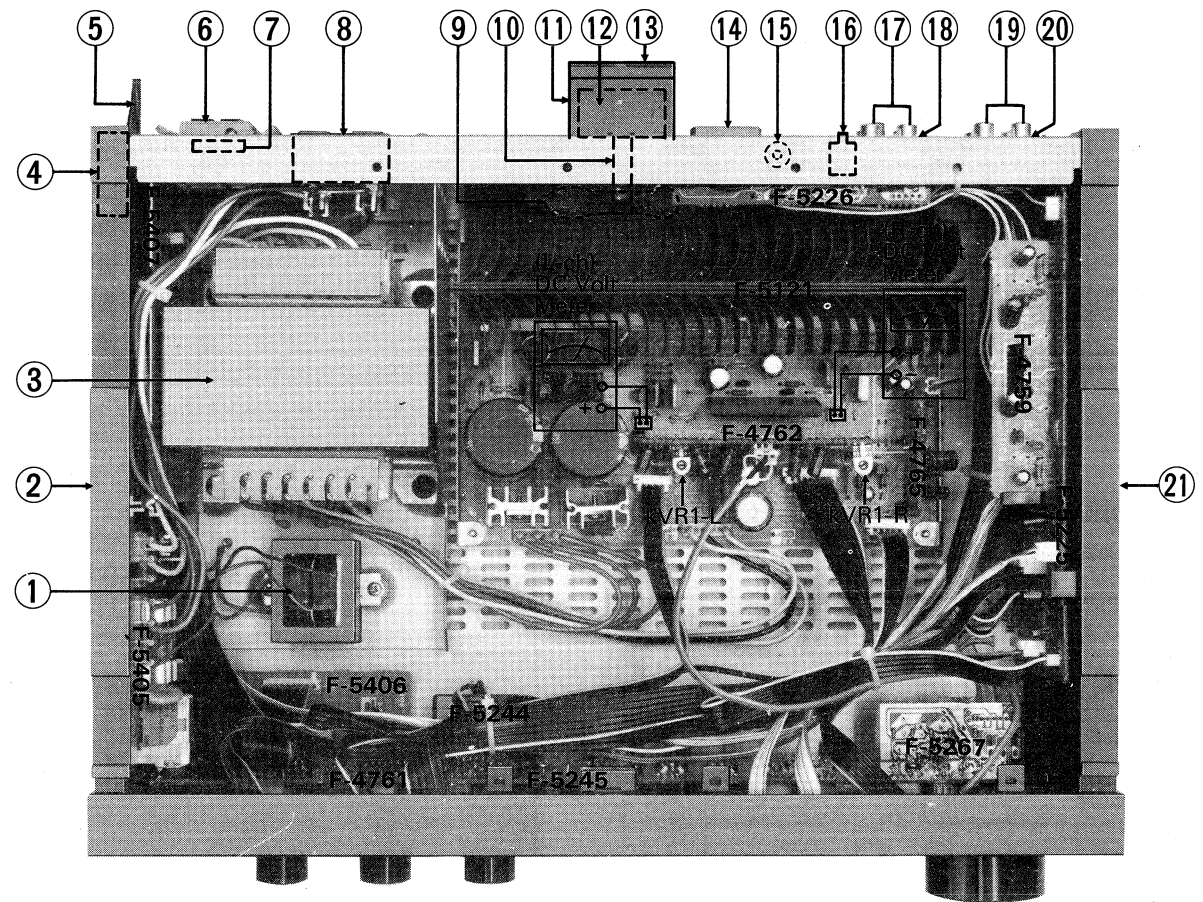

<A-E550>

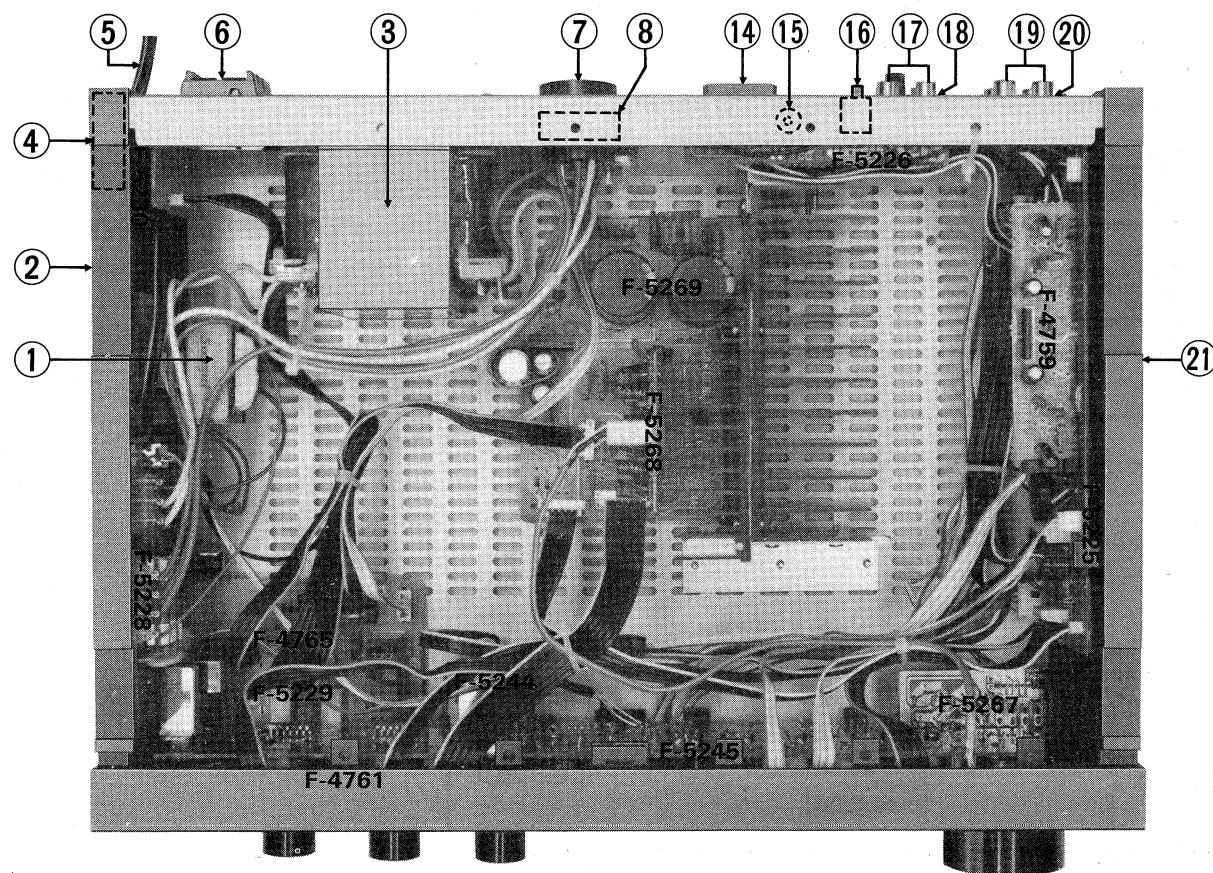

4. INTERIOR BLOCK DIAGRAM OF IC

•STK4913 (Power Amp.)

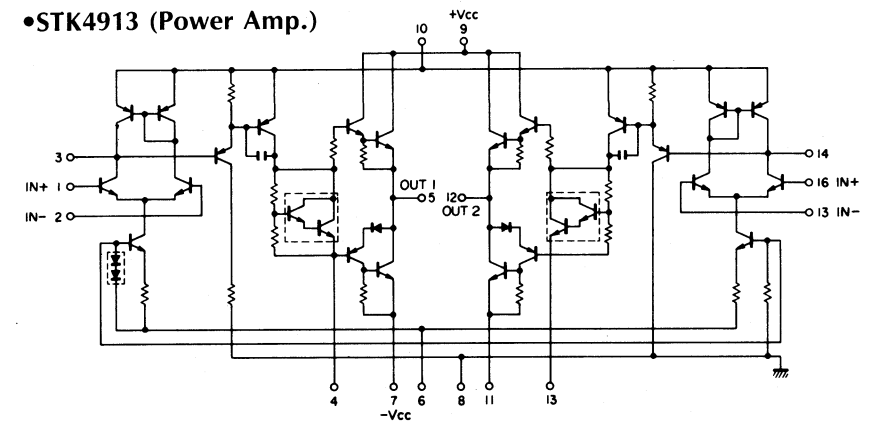

•LC4966/LC4066BH (Analog SW.)

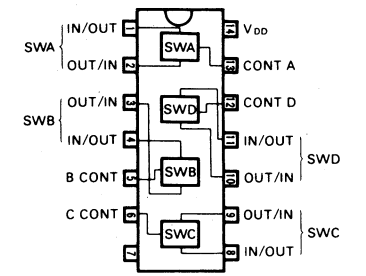

•STK3102-II (Driver Amp.)

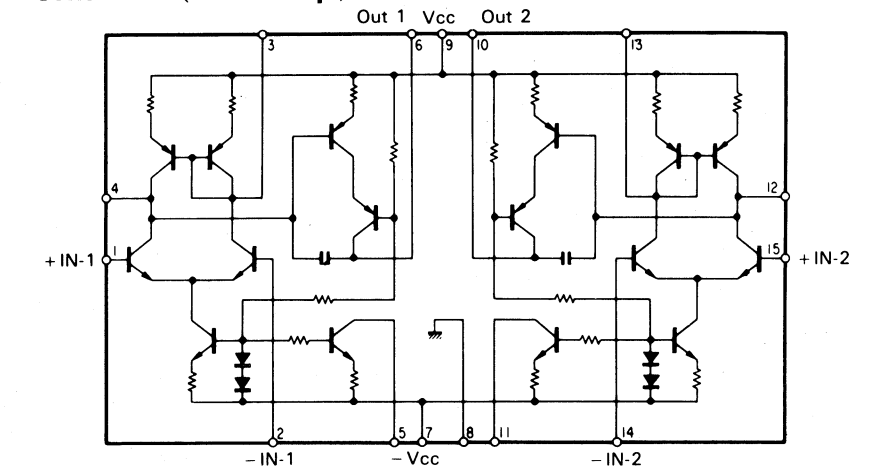

•M5218L (Pre Amp.)

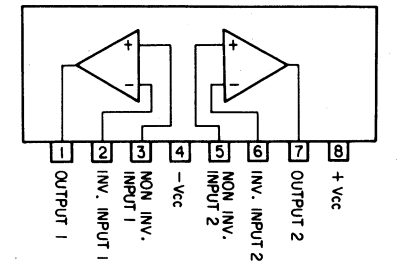

•TA7317P (Speaker Protector)

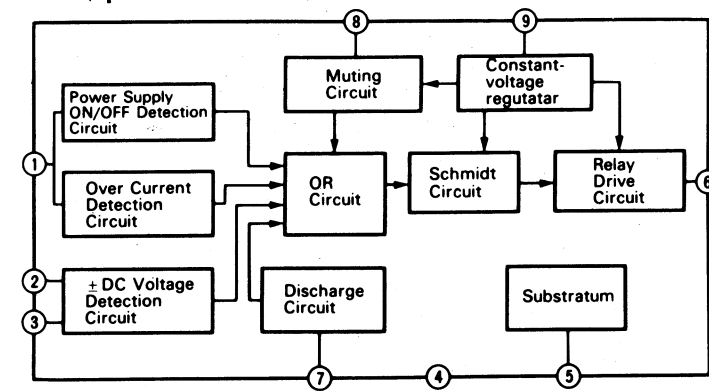

•NJM4558D (OP Amp.)

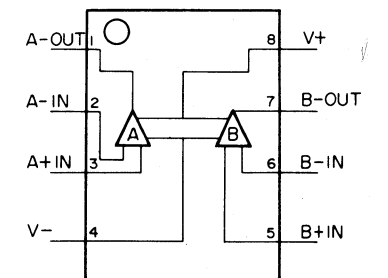

•LA7224 (Remote Control Receiver)

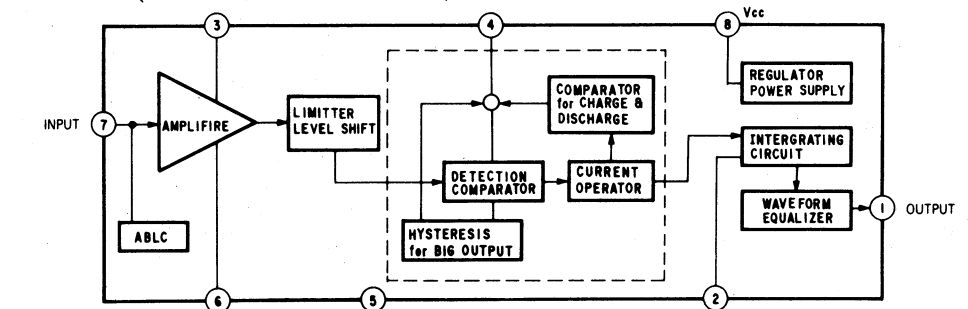

5. TERMINAL FUNCTIONS OF IC μ PD7507CU-220 & LC7530

• μ PD7507CU-220 (Control)

i/o	Port	Pin No.	i/o	Description	ACTIVE		
					H	L	
o	P ₂	0	2	o	Selector Out PHONO		○
		1	3	o	Selector Out 1 CD		○
		2	4	o	Selector Out 2 TUNER		○
		3	5	o	Selector Out 3 TAPE		○
o	P ₃	0	10	o	Volume Up 1 Serial Sig. for V.R.	○	
		1	11	o	Volume Down 1 Serial Sig. for V.R.	○	
		2	12	o	Volume Down Strobe Sig. for V.R.	○	
		3	13	o	Beep		
i	P ₁	0	6	i	Rec Selector In PHONO		○
		1	7	i	Rec Selector In CD		○
		2	8	i	Rec Selector In TAPE		○
		3	9	i	Volume Mode	UP/DOWN	Serial
o	P ₇	0	14	o	Power On/Off	On	Off
		1	15	o	Busy Out		Busy
		2	16	o	Mute	On	Off
		3	17	o	Serial Send REQ		○
i	P ₀	0/INTO	23	i	T/T In	STOP	PLAY
		1/ \overline{SCK}	24	i	Shuf Off In	Timer Start	Shut Off
		2/ \overline{So}	25	i	Timer On/Off In	Power Off	On
		3/ \overline{Si}	26	i	Sleep In	Power Off	On
i/o	P ₆	0	27	i	Remote Cont. In		
		1	28	i	Remote Cont. On/Off In		
		2	29	i	R/T In	R	T
		3	30	i/o	Compu Selector In/ Set Select Out TUNER		○
o	P ₅	0	31	o	Parallel Sig. o/ Serial Sig.	○	
		1	32	o	Parallel Sig. Out 1	○	
		2	33	o	Parallel Sig. Out 2	○	
		3	34	o	Parallel Sig. Out 3	○	
i/o	P ₄	0	35	i/o	Compu Selector In/ Set Select Out PHONO		○
		1	36	i/o	Compu Selector In/ Set Select Out CD		○
		2	37	i/o	Compu Selector In/ TUNER		○
		3	38	i/o	Compu Selector In/ Set Select Out TAPE		○
o	ϕ Out/x2	1	o				
i	EVENT/x2	40	i				
i	INT 1	22	i	S In		○	

•Function of each port

A. P₄ Port: Active "L"

- When signal is input from remote controller, this port supply select signal for proper set.
In case of phono, P₄₀ port signal is it's start/stop control signal.
- Signal of input selector ... Signal from tact sw. or set for source.
 - When depress any sw. at the same time, signal which remains at the last receive.
 - Manage time for chattering = 25mS.
 - When this port receive signal from remote controller, refuse signal from tact sw. and set for source. (1st Date)

B. P₅ port: 4 bit date bus, for DECK, TUNER and CD.
This port supply date which correspond with input date.

C. P₂ port: Control signal which is input selector for amplifier Out, Indicator Drive
Change bit of position which correspond with input date from "H" level to "L" leve.

D. P₇₋₀: Power On/Off
This terminal supply "H" voltage level at power on condition and "L" voltage level at power off condition.

E. P₃₋₀: Serial date for volume Up/V.R. Out

- This terminal supply one plus whenever input signal.
- When signal input two seconds or more continually, this terminal supply on pulse at intervals of 10mS till no input signal.

F. P₃₋₁: Serial date for volume Down/V.R. Out
Same as "E. P₃₋₀".

G. P₆₋₀: Input terminal for date from remote controller
Signal are inputted through wave shaping circuit.

H. P₀₋₀: Signal of platter

- This terminal input signal in order to recognize condition of disc player. (play or stop)
- When platter is play condition, this terminal input "L" voltage level.

I. INT 1: S Input

- When this terminal changed from "L" voltage level to "H" voltage level (), mute signal terminal (P₇₋₂) supply "H" voltage level, beep terminal (P₃₋₃) supply on signal continually and forbid all input function.
- And power on/off terminal (P₇₋₀) change "L" voltage level.
- No release from this condition till power on again.

J. P₇₋₂: Mute Out

- When mode of power on/off or selector out (P₂ port) are changed, and remote control terminal (P₆₋₀, P₆₋₁) or P₄ port is inputted signal, this terminal supply the signal.
- Even, it is inputted signal of same mode, not supply.

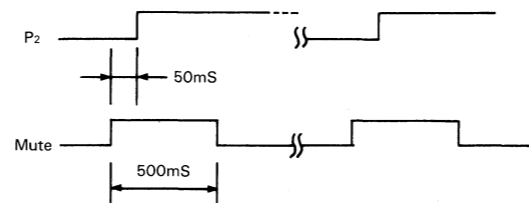

K. P₃₋₃: Beep Out

- When remote control terminal and P₄ port is inputted signal, this terminal supply the signal for 50mS. (Even, this terminal is inputted the signal of same mode, it supply.)
- f = 1 ~ 2kHz

L. P₁ Port: Rec Selector Input

- This terminal input signal in order to recognize rec selector position.
- When depress phono sw. and tape sw. at the same time, this terminal change for inputting function for power on/off.

M. P₇₋₃: Serial send REQ.
When it supply the serial date, this is it's request signal.

N. P₀₋₁: Shut Off Input
This is input terminal for timer start or shut off of deck.

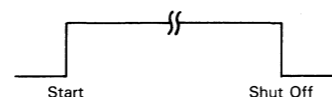

O. P₀₋₂: Timer On/Off Input

- This terminal is inputted signal of power control from timer unit.
- "H" voltage level..... Power off contition.
- "L" voltage level..... Power on contiction.

P. P₀₋₃: Sleep Input
Same as "O. P₀₋₂".

Q. P₆₋₂: R/T Input
This terminal input signal in order to select mode of receiver or tuner.

R. P₇₋₁: Busy

- When condition of IC is changed by remote controller, it supply.
- Active "L"

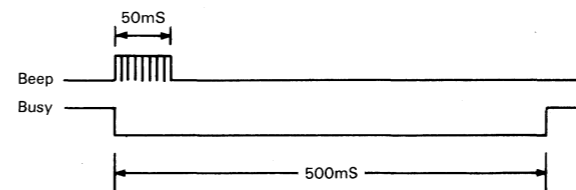

•LC7530 (Electronic Sound Volume IC)

<Description of Terminals>

Pin No.	Terminal Name	Description																																																																																																																																																									
1~8	IND1~8	Sound volume position displaying output terminals: When INIT is at "L", only IND5 is at "H".																																																																																																																																																									
<table border="1"> <thead> <tr> <th>Control terminal of analog switch</th> <th colspan="8">IND</th> </tr> <tr> <th></th> <th>1</th> <th>2</th> <th>3</th> <th>4</th> <th>5</th> <th>6</th> <th>7</th> <th>8</th> </tr> </thead> <tbody> <tr><td>1</td><td>H</td><td></td><td></td><td></td><td></td><td></td><td></td><td></td></tr> <tr><td>2</td><td>H</td><td>H</td><td></td><td></td><td></td><td></td><td></td><td></td></tr> <tr><td>3</td><td></td><td>H</td><td></td><td></td><td></td><td></td><td></td><td></td></tr> <tr><td>4</td><td></td><td></td><td>H</td><td>H</td><td></td><td></td><td></td><td></td></tr> <tr><td>5</td><td></td><td></td><td></td><td>H</td><td></td><td></td><td></td><td></td></tr> <tr><td>6</td><td></td><td></td><td></td><td></td><td>H</td><td>H</td><td></td><td></td></tr> <tr><td>7</td><td></td><td></td><td></td><td></td><td></td><td>H</td><td></td><td></td></tr> <tr><td>8</td><td></td><td></td><td></td><td></td><td></td><td></td><td>H</td><td>H</td></tr> <tr><td>9</td><td></td><td></td><td></td><td></td><td></td><td></td><td>H</td><td></td></tr> <tr><td>10</td><td></td><td></td><td></td><td></td><td></td><td></td><td>H</td><td>H</td></tr> <tr><td>11</td><td></td><td></td><td></td><td></td><td></td><td></td><td></td><td>H</td></tr> <tr><td>12</td><td></td><td></td><td></td><td></td><td></td><td></td><td></td><td>H</td></tr> <tr><td>13</td><td></td><td></td><td></td><td></td><td></td><td></td><td></td><td>H</td></tr> <tr><td>14</td><td></td><td></td><td></td><td></td><td></td><td></td><td></td><td>H</td></tr> <tr><td>15</td><td></td><td></td><td></td><td></td><td></td><td></td><td></td><td>H</td></tr> </tbody> </table>			Control terminal of analog switch	IND									1	2	3	4	5	6	7	8	1	H								2	H	H							3		H							4			H	H					5				H					6					H	H			7						H			8							H	H	9							H		10							H	H	11								H	12								H	13								H	14								H	15								H
Control terminal of analog switch	IND																																																																																																																																																										
	1	2	3	4	5	6	7	8																																																																																																																																																			
1	H																																																																																																																																																										
2	H	H																																																																																																																																																									
3		H																																																																																																																																																									
4			H	H																																																																																																																																																							
5				H																																																																																																																																																							
6					H	H																																																																																																																																																					
7						H																																																																																																																																																					
8							H	H																																																																																																																																																			
9							H																																																																																																																																																				
10							H	H																																																																																																																																																			
11								H																																																																																																																																																			
12								H																																																																																																																																																			
13								H																																																																																																																																																			
14								H																																																																																																																																																			
15								H																																																																																																																																																			
*Blanks are all floating terminals H: P-channel comes on.																																																																																																																																																											

S. P₃₋₂: Strobe signal Out
When it supply serial date for volume, it supply.

T. P₁₋₃: Method of volume control select

- This terminal input signal in order to select method of Up/Down or serial.
- Method of Up/Down Out..... "H" voltage level
- Method of serial "L" voltage level

U. P₆₋₃: Compu. Sel./Set Select Out
This terminal is I/O terminal that it is compu.sel. input and set-select out for tuner.

Pin No.	Terminal Name	Description
9,14	SIG1,2	Analog switch input terminal: Signals to be attenuated by the IC are inputted.
10,13	COM 1, 2	Analog switch output terminal: Signals attenuated by the IC are outputted.
11	V _M	Bias voltage terminal: When a signal bias voltage is required, this terminal voltage (1/2 V _{DD}) is used.
12	V _{SS}	GND terminal
15	CE	When this terminal voltage is set to GND level, the IC is set to back-up mode and the output is in a floating state. Power consumption is reduced.
16	INIT	Initial terminal: If at "L", step is 9 and terminal IND5 changes to "H".
17	DN	When this terminal voltage is decreased, the step decreases and attenuation constant increases. Further, if kept at "L", attenuation constant increases continuously; however, the instant the terminal voltage is set to "H", the attenuation constant is held at that step.
18	UP	This terminal voltage functions reversely of that at DN terminal. When UP and DN are both at "L", UP terminal has a priority. Further, terminal voltages at UP and DN stop changing in response to MSB or LSB.
19	CR	This terminal is used to determine step speed. Resistors and capacitors are connected (open drain).
20	V _{DD}	Positive power supply terminal

6. ADJUSTMENT <A-E750> (See Top View on page 10)

- Note:**
- Master Volume Minimum
 - Room Temperature 18°C ~ 28°C (65°F ~ 83°F)
 - For this adjustment, run the unit for more than 5 minutes after the power is switched ON.

- Before turning ON power switch, set kVR1 on F-4762 to center position.

STEP	SUBJECT	MEASURE OUTPUT	ADJUST	ADJUST FOR	REMARKS
1.	Bias Current Adj. L-CH	Test Terminal (TP) <Between emitters of power transistors (kQ4L & kQ5L)>	kVR1, L-ch (F-4762)	DC 7.5mV ± 1mV	•This bias value is converted from current value into voltage by ohms law.
2.	Bias Current Adj. R-CH	Test Terminal (TP) <Between emitters of power transistors (kQ4R & kQ5R)>	kVR1, R-ch (F-4762)	DC 7.5mV ± 1mV	

7. SCHEMATIC DIAGRAM 7-1. A-E750

• Design and specifications subject to change without notice for improvement.
 • La présentation et les spécifications sont susceptibles d'être modifiées sans préavis par suites d'améliorations éventuelles.
 • Änderungen, die dem technischen Fortschritt dienen, bleiben vorbehalten.

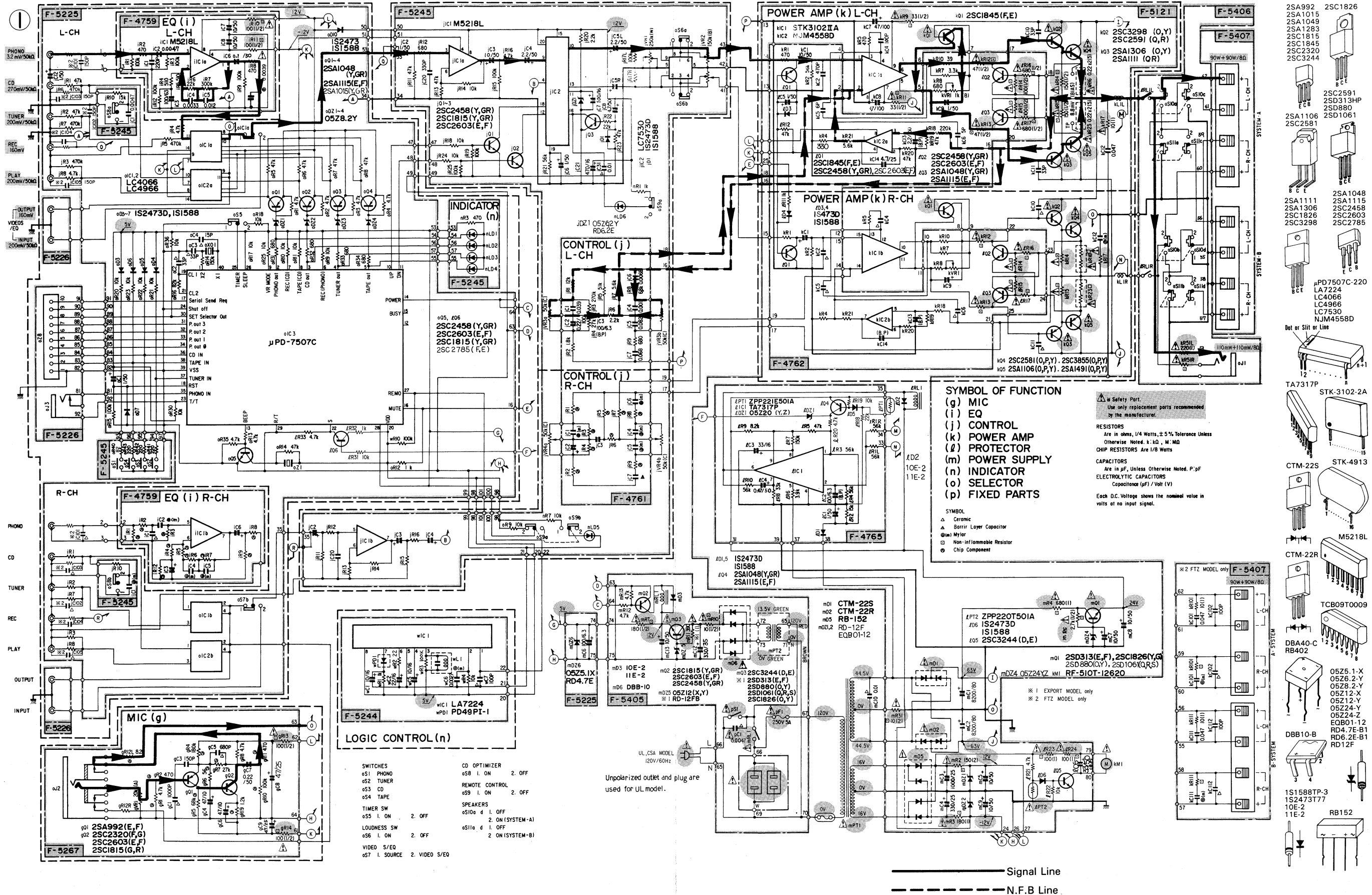

7-2. A-E550

* Design and specifications subject to change without notice for improvement.
 * La présentation et les spécifications sont susceptibles d'être modifiées sans préavis par suites d'améliorations éventuelles.
 * Änderungen, die dem technischen Fortschritt dienen, bleiben vorbehalten.

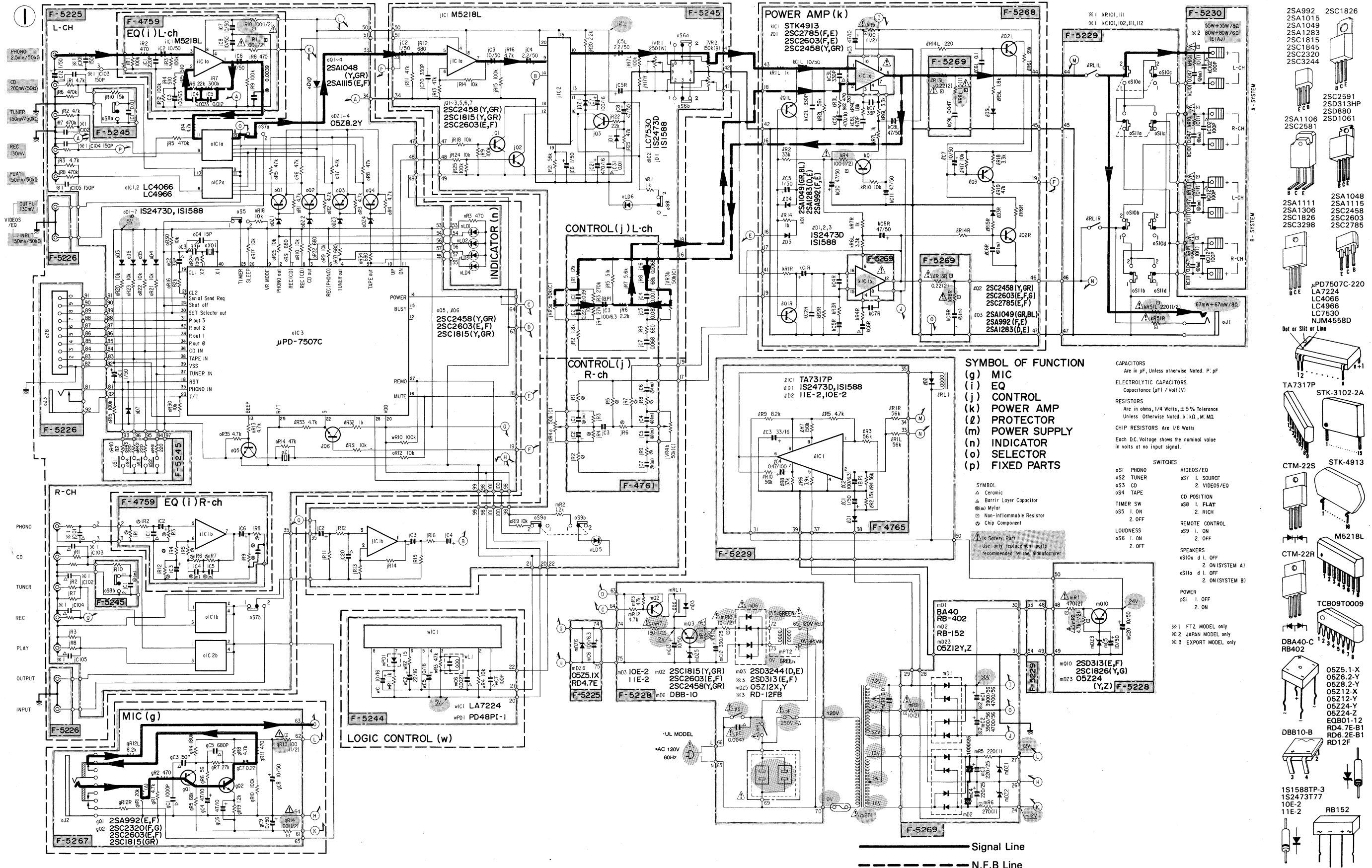

SYMBOL OF FUNCTION
 (g) MIC
 (i) EQ
 (j) CONTROL
 (k) POWER AMP
 (l) PROTECTOR
 (m) POWER SUPPLY
 (n) INDICATOR
 (o) SELECTOR
 (p) FIXED PARTS

CAPACITORS
 Are in pF, Unless otherwise Noted. P: pF
ELECTROLYTIC CAPACITORS
 Capacitance (μF) / Volt (V)
RESISTORS
 Are in ohms, 1/4 Watts, ±5% Tolerance
 Unless Otherwise Noted. k: kΩ, M: MΩ
CHIP RESISTORS Are 1/8 Watts
 Each D.C. Voltage shows the nominal value
 in volts at no input signal.

- 2SA992
- 2SA1015
- 2SA1049
- 2SA1283
- 2SC1815
- 2SC1845
- 2SC2320
- 2SC2444
- 2SC2591
- 2SD313P
- 2SD880
- 2SD1061
- 2SA1106
- 2SC2581
- 2SA1048
- 2SA1115
- 2SA1306
- 2SC2458
- 2SC1826
- 2SC2603
- 2SC3298
- μPD7507C-220
- LA7224
- LC4066
- LC4966
- LC7530
- NJM4558D
- TA7317P
- STK-3102-2A
- CTM-22S
- STK-4913
- CTM-22R
- M5218L
- TCB09T0009
- DBA40-C
- RB402
- 05Z5.1-X
- 05Z6.2-Y
- 05Z8.2-Y
- 05Z12-X
- 05Z12-Y
- 05Z24-Y
- 05Z24-Z
- E0B01-12
- RD4.7E-B1
- RD6.2E-B1
- RD12F
- 1S1588TP-3
- 1S2473177
- 10E-2
- 11E-2
- RB152

1
2
3
4
5

7-3. A-E750 Power Supply Section <XX•EU•UK•SEV>

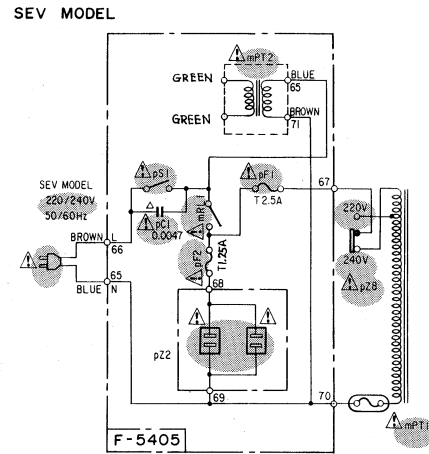
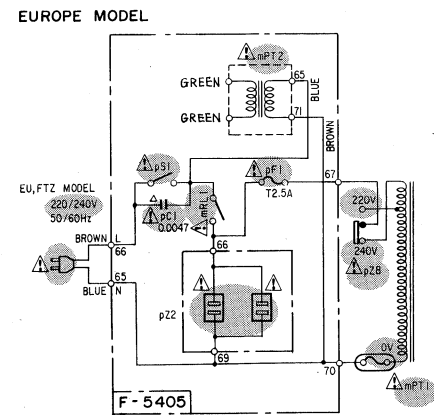
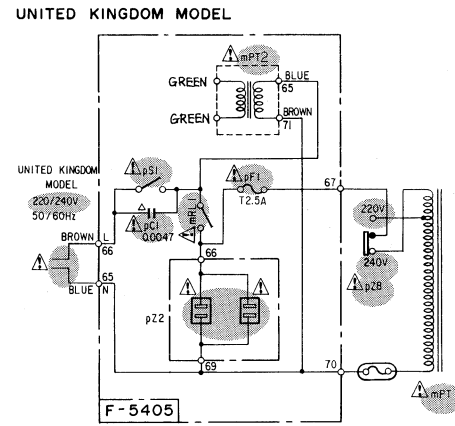
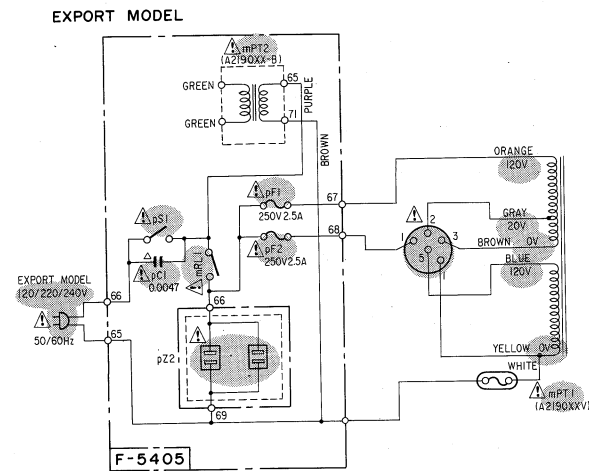

7-4. A-E550 Power Supply Section <XX•EU•UK•SEV>

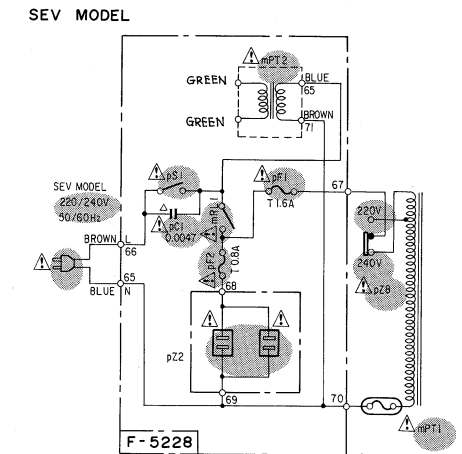
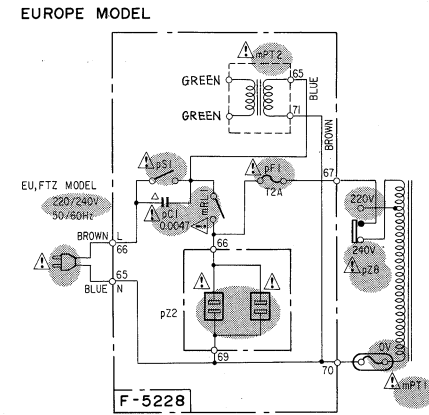
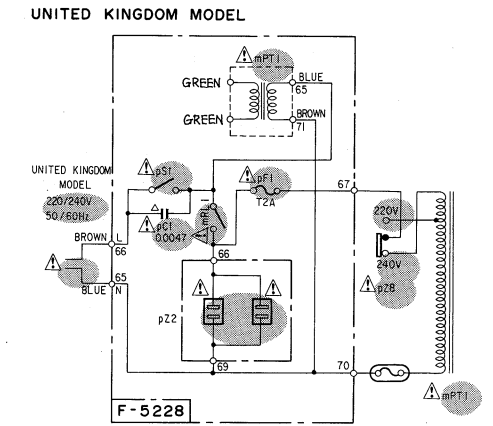
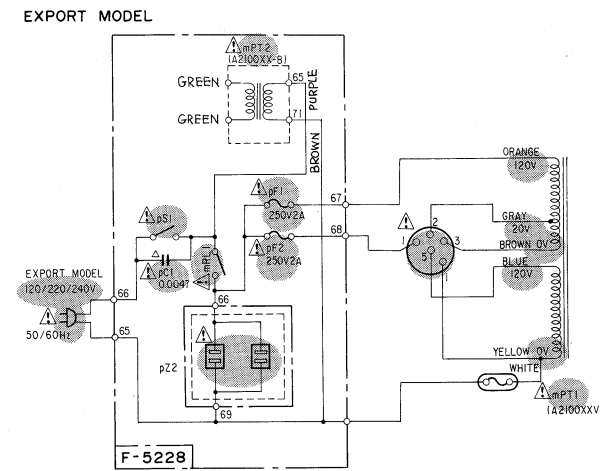

8. PACKING LIST

Parts No.	Stock No.	Description
1	47859900	Vinyl Cover
2	27056600	Styrofoam Packing
3	27172000	Carton Case (A-E750)
	27164000	Carton Case (A-E550)
4	27203800	Sub Styrofoam Packing (A-E750)

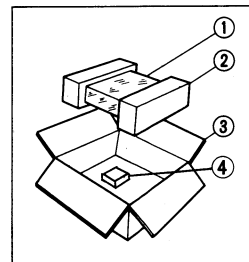

9. ACCESSORY LIST

Stock No.	Description
48416900	ST Connection Cable
	Dry Battery (SUM-3X2)
46996300	Operating Instruction (*E•F•S)
46996400	Operating Instruction (*G•I•Sw)
	Remote Control Unit (RS-B1)
46998600	Operating Sheet

* Note:
E•F•S: English•French and Spanish Version
G•I•Sw: German•Italian and Swedish Version

SANSUI ELECTRIC CO., LTD.:
SANSUI ELECTRONICS CORPORATION:
SANSUI ELECTRONICS (U.K.) LTD.:
SANSUI ELECTRONICS G.M.B.H.:

14-1, Izumi 2-chome, Suginami-ku, Tokyo 168 Japan
PHONE: (03) 324-8891/TELEX: 232-2076 (International Division)
1250 Valley Brook Ave. Lyndhurst, N.J. 07071 U.S.A.
17150 South Margay Ave. Carson, California 90746 U.S.A.
3036 Koapaka Street, Honolulu, Hawaii 96819 U.S.A.
Unit 10A, Lyon Industrial Estate, Rockware Avenue, Greenford, Middx UB6, OAA, England
Pau Ehrich Strasse 8, 6074 Rödermark 2, West Germany