

SERVICE MANUAL

INTEGRATED STEREO AMPLIFIER

SANSUI AU-2900

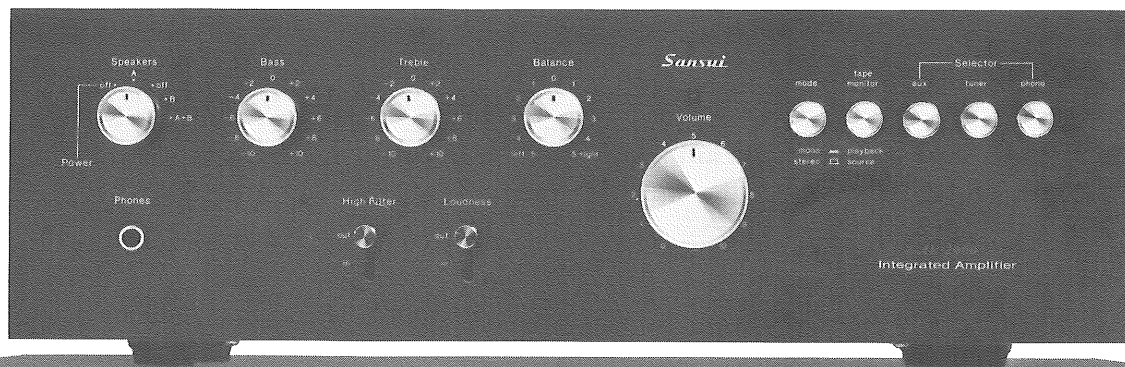

Sansui

SANSUI ELECTRIC CO., LTD.

1. SPECIFICATIONS

POWER OUTPUT

Min. RMS, both channels driven, from 40 to 20,000Hz, with no more than 0.3% total harmonic distortion

15 watts per channel into 8 ohms

Min. RMS, both channels driven, at 1,000Hz, with no more than 0.3% total harmonic distortion
17 watts per channel into 8 ohms

LOAD IMPEDANCE 8 ohms (SYSTEM-A or B)

POWER BANDWIDTH 40 to 20,000Hz at or below rated min. RMS power output and total harmonic distortion

TOTAL HARMONIC DISTORTION

..... less than 0.3% at or below rated min. RMS power output

INTERMODULATION DISTORTION

(70Hz:7kHz=4:1 SMPTE method)

..... less than 0.5%

FREQUENCY RESPONSE (at 1 watt)

..... 10 to 40,000Hz ± 0.5 dB -2.0 dB

RIAA CURVE DEVIATION (PHONO)

..... ± 0.5 dB, -0.5 dB (30Hz to 15kHz)

DAMPING FACTOR approximately 30 at 8 ohms load

INPUT SENSITIVITY AND IMPEDANCE

(1 kHz, for rated power output)

PHONO 2.5mV/50 kilohms

(Max. input capability: 170mV at 1kHz, less than 0.5% total harmonic distortion)

TUNER 130mV/50 kilohms

AUX 130mV/50 kilohms

TAPE PLAY (pin jacks) 130mV/50 kilohms

OUTPUT LEVEL (1,000Hz)

TAPE REC (pin jacks) 100 mV

CHANNEL SEPARATION (1 kHz, at rated power output)

PHONO better than 57dB

TUNER better than 60dB

AUX better than 60dB

TAPE PLAY better than 60dB

HUM AND NOISE (IHF)

PHONO better than 75dB

TUNER better than 90dB

AUX better than 90dB

TAPE PLAY better than 90dB

CONTROLS

BASS $+12$ dB, -12 dB (50Hz)

TREBLE $+12$ dB, -12 dB (15kHz)

LOUDNESS (volume control: -30 dB) $+10$ dB (50Hz)
 $+8$ dB (10 kHz)

HIGH FILTER -3 dB (7 kHz, 6dB/oct.)

POWER REQUIREMENTS

POWER VOLTAGE 100, 120, 220, 240V 50/60Hz
120V(Usable 110~130V)60Hz
(for U.S.A. & Canada only)

POWER CONSUMPTION. 50 watts (rated)
110 watts, 125 VA (max.),

DIMENSIONS

400 mm (15 $\frac{3}{4}$ ") W

120 mm (4 $\frac{3}{4}$ ") H

240 mm (9 $\frac{1}{2}$ ") D

WEIGHT

5.7 kg (12.6 lbs) net

6.7 kg (14.8 lbs) packed

* Design and specifications subject to change without notice for improvements.

TABLE OF CONTENTS

<u>Section</u>	<u>Title</u>	<u>Page</u>
1.	SPECIFICATIONS	1
2.	ADJUSTMENTS	2
	2-1. Bias Current Adjustment	2
3.	OTHER PARTS (Front & Back Side)	3
◇	COMMON PARTS LIST FOR RESISTORS & CAPACITORS ONLY	(EXTRA NUMBER)
4.	PARTS LOCATION AND PARTS LISTS	4
	4-1. F-2555 Tone Control Circuit Board	4
	4-2. F-2554 Driver Circuit Board	4
	4-3. F-2556 Switch Circuit Board	4
	4-4. F-2587 Connector Circuit Board	4
	4-5. Figures	4
5.	SCHEMATIC DIAGRAM	5
6.	OPERATION BLOCK DIAGRAM	6
7.	TROUBLESHOOTING	6
8.	PACKING LIST	BACK COVER
9.	ACCESSORY PARTS LIST	BACK COVER

2. ADJUSTMENTS

2-1. Bias Current Adjustment

- Note:**
1. Confirm the AC Power Supply voltage.
 2. Master Volume.....Minimum
 3. Room Temperature18°C~28°C
(65°F~83°F)
 4. For this adjustment, run the unit for more than 3 minutes after power is switched ON.
 5. Before this adjustment, turn VR01 and VR02 fully counterclockwise.

Fig. 2-1

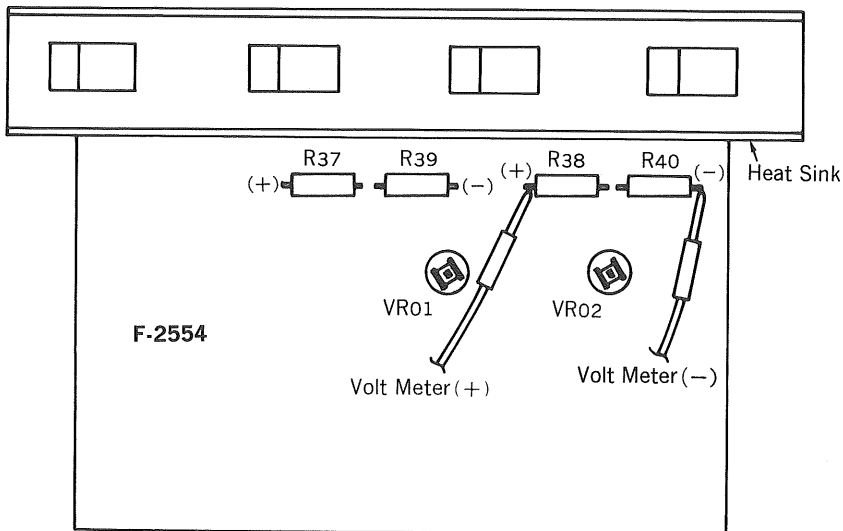

STEP	SUBJECT	EQUIPMENT	MEASURE OUTPUT	ADJUST	ADJUST FOR
1	Bias Current L-CH	DC Volt meter	*1) See below	VR01 F-2554 (See Fig. 2-1)	13mV ±1mV (20mA)
2	Bias Current R-CH	DC Volt meter	*2) See below	VR02 F-2554 (See Fig. 2-1)	13mV ±1mV (20mA)

*1) For this measurement, put the lead (+) side of volt meter to (+) side of R37 and the lead (-) side to (-) side of R39 on F-2554 as Fig. 2-1.

*2) For this measurement, put the lead (+) side of volt meter to (+) side of R38 and the lead (-) side to (-) side of R40 on F-2554 as Fig. 2-1.

(F-2554 Driver Circuit Board)

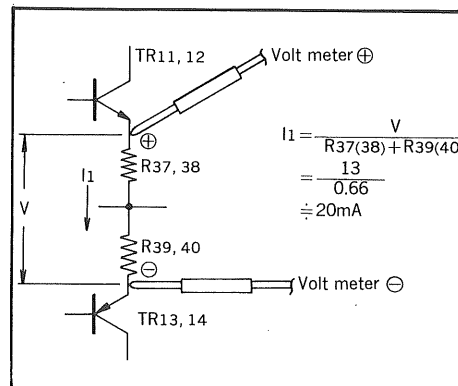

3. OTHER PARTS

(Front Side)

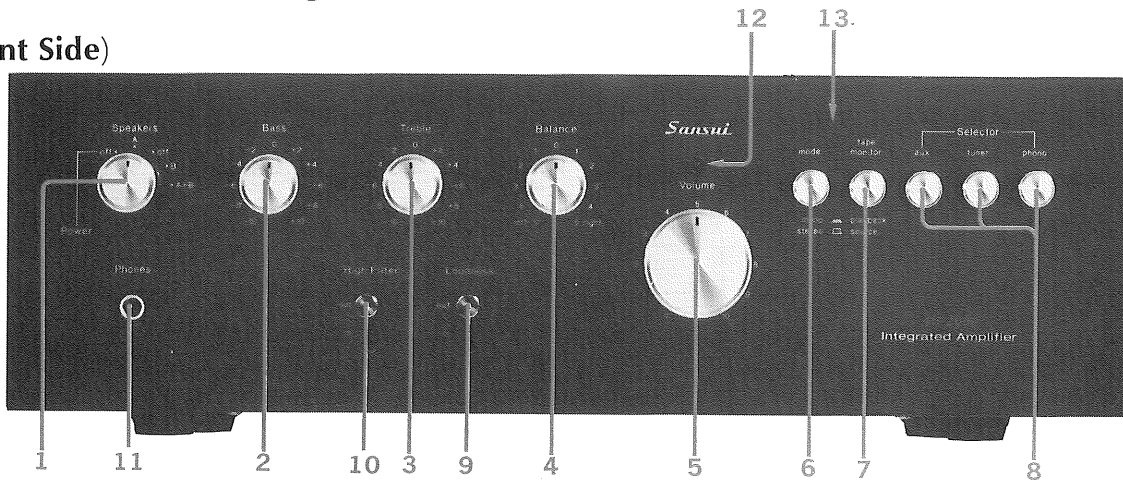

(Back Side)

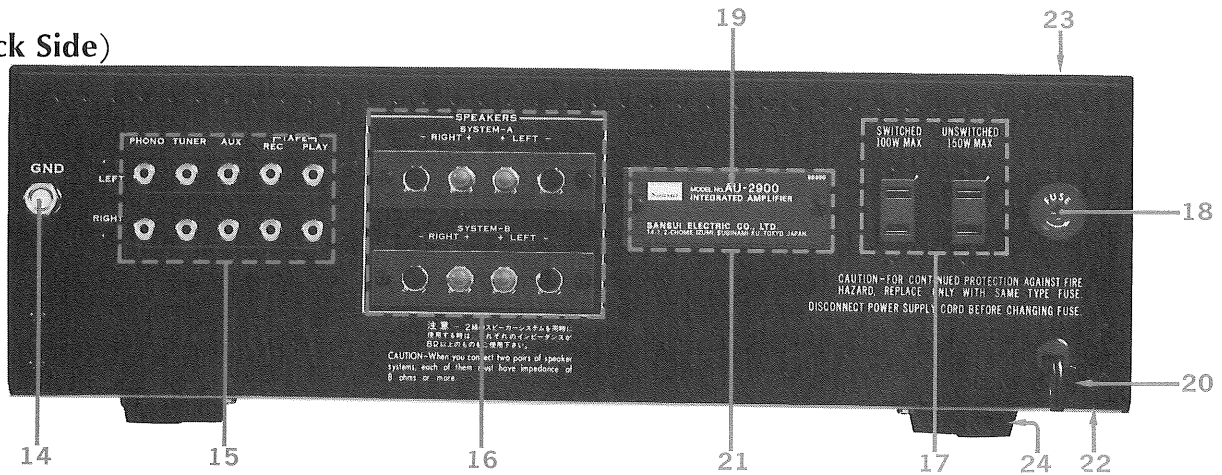

Parts List

Parts No.	Stock No.	Description
1	5318610	S-11 Type Knob, SPEAKERS
	1101550, 1	Rotary Switch Y-1-4-5, SPEAKERS
2	5318610	S-11 Type Knob, BASS VOLUME
	1015080, 1	100kΩ(A) × 2 BASS VOLUME
3	5318610	S-11 Type Knob, TREBLE VOLUME
	1015080, 1	100kΩ(A) × 2 TREBLE VOLUME
4	5318610	S-11 Type Knob, BALANCE VOLUME
	1015070, 1	100kΩ(M.N) × 2 BALANCE VOLUME
5	5318630	L-4 Type Knob, VOLUME
	1011070, 1	250kΩ(B) × 2, VOLUME
	5326500	Push Button (B)
6	5396190	Ring, Push Button
	1131120	Push Switch, Mode
	5326500	Push Button (B)
7	5396190	Ring, Push Button
	1131120	Push Switch, Tape Monitor
	5326500	Push Button (B)
8	5396190	Ring, Push Button
	1131120	Push Switch, Selector
	5326520	E-3 Type Knob, Lever Switch
9	5047470	Masking, Lever Switch
	1170340	SX15-1 Lever Switch, LOUDNESS
	5326520	E-3 Type Knob, Lever Switch
10	5047470	Masking, Lever Switch
	1170350	SX15-2 Lever Switch, HIGH FILTER

Parts No.	Stock No.	Description
11	2430190	Headphone Jack
12	7726080	L.E.D Ass'y
13	7007310	Front Panel
14	2230051	Ground Terminal
15	2200350	10P Input Terminal
16	2210200	Speaker Terminal
17	2450060	AC Outlet
18	0431220	1.0A 250V (AC 220~240V) } Power Fuse
	0431230	
		2300060
19	5388900	Name Plate
20	3800261, 2	Power Cord
	2410830	Voltage Selector, Plug
21	2410091	Voltage Selector, Socket
22	5058580	Bottom Plate
23	5006580	Bonnet
24	5516940	Foot
T701	4002410	Power Transformer
F883, F884	0433260	Speaker Fuse, 3.5A 250V
F881, F882	0431270	AC Fuse, 4A 250V
C703	0659801	0.01μF 150V C.C.
C701	0657473	0.047μF 50V C.C.
R701	0104221	220Ω 1W C.R.
R702		

SANSUI

COMMON PARTS LISTS FOR RESISTORS & CAPACITORS ONLY

Replacement Parts, most resistors & capacitors are common to Sansui models unless specified otherwise, therefore these resistors and capacitors in this list are not shown in parts lists of Service Manual. When replacing these parts, confirm the value, wattage (or capacity) and tolerance referring to this list and Schematic Diagram for easier check.

When ordering parts, use the parts name and Stock No. referring to Parts Lists.

◇ TYPES OF COMMON RESISTORS & CAPACITORS

[Resistors]

Carbon resistor 1/4W

Solid resistor 1/4W

[Capacitors]

Ceramic capacitor

1) 50V Standard type

2) 50V Temperature compensation type

Mylar capacitor (50V)

Electrolytic capacitor
(Vertical type)

1) Non-polar type (6.3V~80V)

2) Polar type (6.3V~80V)

3) Polar type (25V & 50V)
(low noise)

◇ Resistors

— How to read color cord —

Carbon resistors



1) Constant

2) Multiplier

Solid resistor



3) Tolerance (%)

4) Tolerance (%)

For example:

1. Brown 2. Red

3. Orange 4. Silver

$12 \times 10^3 (\Omega) \pm 10\%$

12k $\Omega \pm 10\%$

Color	1	2	3	4
Black	0	0	10 ⁰	
Brown	1	1	10 ¹	
Red	2	2	10 ²	
Orange	3	3	10 ³	
Yellow	4	4	10 ⁴	
Green	5	5	10 ⁵	
Blue	6	6	10 ⁶	
Purple	7	7	—	
Gray	8	8	—	
White	9	9	—	
Gold	—	—	10 ⁻¹	± 5%
Silver	—	—	10 ⁻²	± 10%
Colorless	—	—	—	± 20%

► RESISTORS

Value [Ω] Stock No.

Carbon resistors (Standard type)
1/4W Tolerance ±5%

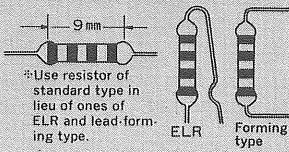

1.5	0107159
1.8	0107189
2.2	0107229
2.7	0107279
3.3	0107339
3.9	0107399
4.7	0107479
5.6	0107569
6.8	0107689
8.2	0107829
10.0	0107100
12.0	0107120
15.0	0107150
18.0	0107180
22.0	0107220
27.0	0107270
33.0	0107330
39.0	0107390
47.0	0107470
56.0	0107560
68.0	0107680
82.0	0107820
100.0	0107101
120.0	0107121
150.0	0107151
180.0	0107181
220.0	0107221
270.0	0107271
330.0	0107331
390.0	0107391
470.0	0107471
560.0	0107561
680.0	0107681
820.0	0107821
1.0 K	0107102
1.5 K	0107152
1.8 K	0107182
2.2 K	0107222
2.7 K	0107272
3.3 K	0107332
3.9 K	0107392
4.7 K	0107472
5.6 K	0107562
6.8 K	0107682
8.2 K	0107822
10.0 K	0107103
12.0 K	0107123
15.0 K	0107153
18.0 K	0107183
22.0 K	0107223
27.0 K	0107273
33.0 K	0107333
39.0 K	0107393
47.0 K	0107473
56.0 K	0107563

Value [Ω] Stock No.

68.0 K	0107683
82.0 K	0107823
100.0 K	0107104
120.0 K	0107124
150.0 K	0107154
180.0 K	0107184
220.0 K	2107224
270.0 K	0107274
330.0 K	0107334
390.0 K	0107394
470.0 K	0107474
560.0 K	0107564
680.0 K	0107684
820.0 K	0107824
1.0 M	0107105

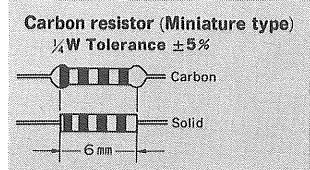

4.7	0240479
5.6	0240569
6.8	0240689
8.2	0240829
10.0	0240100
12.0	0240120
15.0	0240150
18.0	0240180
22.0	0240220
27.0	0240270
33.0	0240330
39.0	0240390
47.0	0240470
56.0	0240560
68.0	0240680
82.0	0240820
100.0	0240101
120.0	0240121
150.0	0240151
180.0	0240181
220.0	0240221
270.0	0240271
330.0	0240331
390.0	0240391
470.0	0240471
560.0	0240561
680.0	0240681
820.0	0240821
1.0 K	0240102
1.2 K	0240122
1.5 K	0240152
1.8 K	0240182
2.2 K	0240222
2.7 K	0240272
3.3 K	0240332
3.9 K	0240392
4.7 K	0240472
5.6 K	0240562
6.8 K	0240682

Value [Ω] Stock No.

8.2 K	0240822
10.0 K	0240103
12.0 K	0240123
15.0 K	0240153
18.0 K	0240183
22.0 K	0240223
27.0 K	0240273
33.0 K	0240333
39.0 K	0240393
47.0 K	0240473
56.0 K	0240563
68.0 K	0240683
82.0 K	0240823
100.0 K	0240104
120.0 K	0240124
150.0 K	0240154
180.0 K	0240184
220.0 K	0240224
270.0 K	0240274
330.0 K	0240334
390.0 K	0240394
470.0 K	0240474
560.0 K	0240564
680.0 K	0240684
820.0 K	0240824
1.0 M	0240105

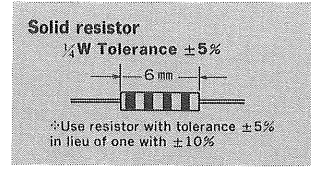

2.2	0113229
2.7	0113279
3.3	0113339
3.9	0113399
4.7	0113479
5.6	0113569
6.8	0113689
8.2	0113829
10.0	0113100
12.0	0113120
15.0	0113150
18.0	0113180
22.0	0113220
27.0	0113270
33.0	0113330
39.0	0113390
47.0	0113470
56.0	0113560
68.0	0113680
82.0	0113820
100.0	0113101
120.0	0113121
150.0	0113151
180.0	0113181
220.0	0113221
270.0	0113271
330.0	0113331
390.0	0113391
470.0	0113471

Value [Ω] Stock No.

560.0	0113561
680.0	0113681
820.0	0113821
1.0 K	0113102
1.2 K	0113122
1.5 K	0113152
1.8 K	0113182
2.2 K	0113222
2.7 K	0113272
3.3 K	0113332
3.9 K	0113392
4.7 K	0113472
5.6 K	0113562
6.8 K	0113682
8.2 K	0113822
10.0 K	0113103
12.0 K	0113123
15.0 K	0113153
18.0 K	0113183
22.0 K	0113223
27.0 K	0113273
33.0 K	0113333
39.0 K	0113393
47.0 K	0113473
56.0 K	0113563
68.0 K	0113683
82.0 K	0113823
100.0 K	0113104
120.0 K	0113124
150.0 K	0113154
180.0 K	0113184
220.0 K	0113224
270.0 K	0113274
330.0 K	0113334
390.0 K	0113394
470.0 K	0113474
560.0 K	0113564
680.0 K	0113684
820.0 K	0113824
1.0 M	0113105
1.2 M	0113125
1.5 M	0113155
1.8 M	0113185
2.2 M	0113225
2.7 M	0113275
3.3 M	0113335
3.9 M	0113395
4.7 M	0113475
5.6 M	0113565

◇CAPACITORS
TOLERANCE (%)

G	J	K	L	M
±2	±5	±10	±15	±20

Value [pF] Stock No. Indication

Ceramic capacitor
1) 50V Standard type
*No color indication on top

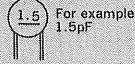

1 (±0.5pF)	0657109	1
1.5	0657159	1.5
2	0657209	2
3	0657309	3
4	0657409	4
5	0657509	5
6	0657609	6
7	0657709	7
8	0657809	8
9	0657909	9
10	0657100	10
12 (±10%)	0657120	12
15	0657150	15
18	0657108	18
22	0657220	22
27	0657270	27
33	0657330	33
39	0657390	39
47	0657470	47 pF
56	0657560	56 pF
68	0657680	68 pF
82	0657820	82 pF
100	0657101	100 pF
120	0657121	120 pF
150	0657151	150 pF
180	0657181	180 pF
220	0657221	220 pF
270	0657271	270 pF
330	0657331	330 pF
390	0657391	390 pF
470	0657471	470 pF
1000 (+80%/-20%)	0657102	0.001 μF
2200	0657222	0.0022 μF
4700	0657472	0.0047 μF
10000	0657103	0.01 μF
22000	0657223	0.022 μF
47000	0657473	0.047 μF

2) 50V Temperature Compensation type

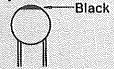

1.0	0669014	1
1.5	0669021	1.5
2.2	0669003	2.2
2.7	0669203	2.7
3.9	0669002	3.9
4.7	0669020	4.7
6.8	0669018	6.8
8.2	0669005	8.2
10.0	0661100	10
12.0	0661120	12
15.0	0661150	15
18.0	0661180	18
22.0	0661220	22
25.0	0661250	25 J

Value [pF] Stock No. Indication

27.0	0661270	27 J
33.0	0661330	33 J
39.0	0661390	39 CM J
47.0	0661470	47 CM J
56.0	0661560	56 CM J
68.0	0661680	68 CM J
82.0	0661820	82 CM J
100.0	0661101	101 CM J

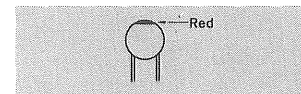

6.8	0669006	6.8
16.0	0662160	16
17.0	0662170	17
19.0	0669279	19
20.0	0662200	20
27.0	0669282	27 J

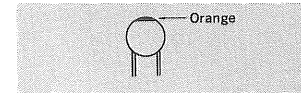

16.0	0663160	16
17.0	0663170	17
20.0	0669305	20
22.0	0669306	22

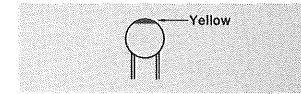

10.0	0664100	10
12.0	0669322	12

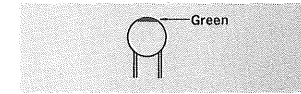

6.8	0669343	6.8
12.0	0666347	12
17.0	0669352	17
18.0	0669019	18

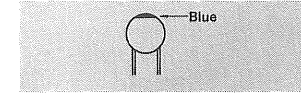

6.8	0669368	6.8
10.0	0669370	10
12.0	0669382	12
15.0	0669383	15

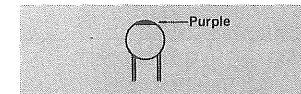

6.8	0669393	6.8
8.2	0669015	8
10.0	0669016	10
33.0	0669408	33
39.0	0669407	39

Value [μF] Stock No. W.V.

Mylar capacitor

*Use capacitor with letter J (±5%) in lieu of one with K (±10%)

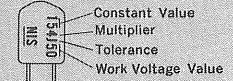

15 × 10⁴ = 150,000 PF
= 0.15 μF (±5%, 50V)

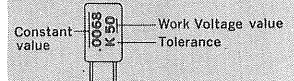

0.0068 μF (±10%, 50V)

0.001	0600106	50V
0.01	0600107	
0.1	0600108	
0.001	0600116	
0.011	0600117	
0.11	0600118	
0.0012	0600126	
0.012	0600127	
0.12	0600128	
0.0013	0600136	
0.013	0600137	
0.13	0600138	
0.0015	0600156	
0.015	0600157	
0.15	0600158	
0.0016	0600166	
0.016	0600167	
0.16	0600168	
0.0018	0600186	
0.018	0600187	
0.18	0600188	
0.002	0600206	
0.02	0600207	
0.2	0600208	
0.002	0600226	
0.022	0600227	
0.22	0600228	
0.0024	0600246	
0.024	0600247	
0.0027	0600276	
0.027	0600277	
0.27	0600278	
0.003	0600306	
0.03	0600307	
0.0033	0600336	
0.033	0600337	
0.33	0600338	
0.0036	0600366	
0.036	0600367	
0.0039	0600396	
0.039	0600397	
0.39	0600398	
0.004	0600406	
0.04	0600407	
0.0043	0600436	
0.043	0600437	
0.0047	0600476	
0.047	0600477	

6. OPERATION BLOCK DIAGRAM

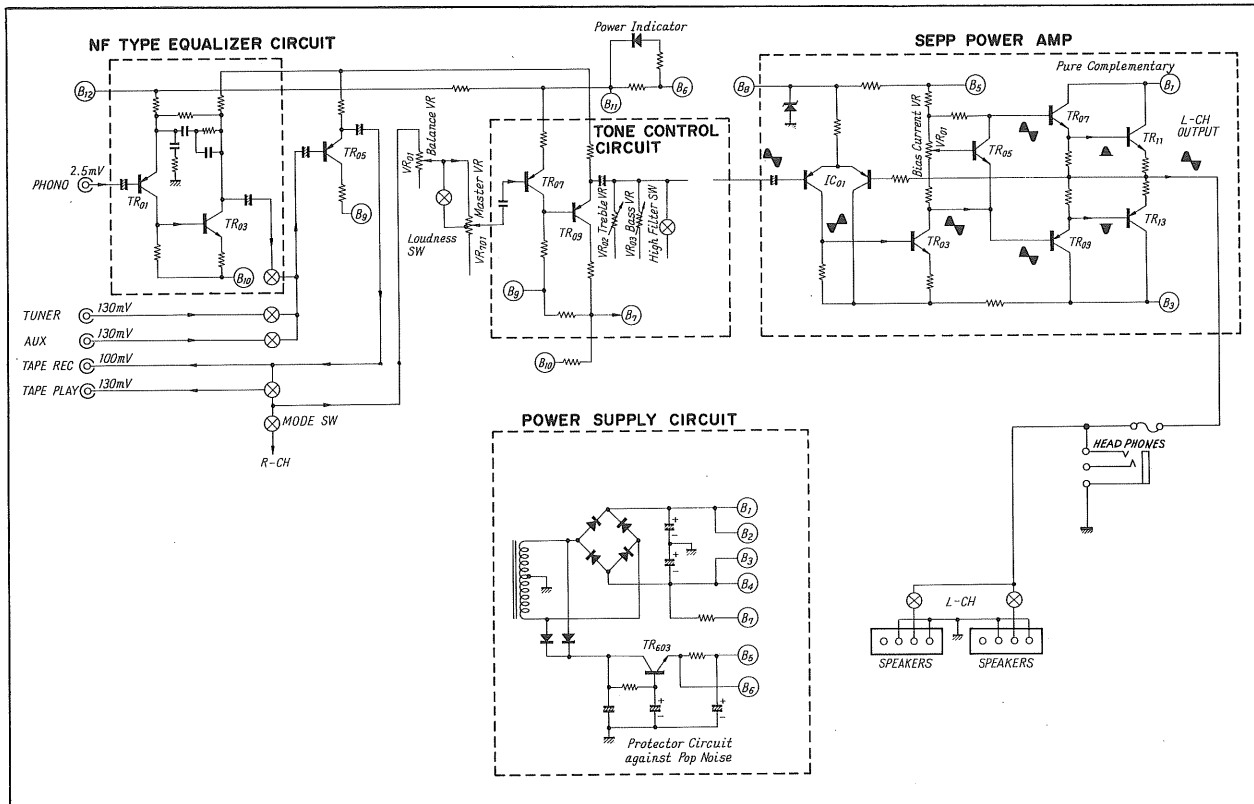

7. TROUBLESHOOTING

Symptom

Cause

7-1. Troubles on Power Supply Section

- 1-1. Opened AC circuitry on primary side of power transformer ————
1. Imperfect contact of power switch, S05
 2. Power fuse, F701 open
 3. AC fuse, F881~F882 open
 4. Defective D607, D609, D611 or D613 on F-2554
 5. Defective TR603 on F-2554

7-2. Troubles on Power Amplifier Section

- 2-1. AC fuse, F881~F882 blown when switching power ON ————
- 2-2. Speaker fuse open ————
- 2-3. Power amplifier section inoperative ————
1. TR07~TR14 on F-2554 short
 2. TR05 or TR06 on F-2554 open
 3. Speaker wires (+ and - side) shorted on speaker terminals
 4. Miss-connections of speaker wires
 5. Defective IC01, TR03 on F-2554

7-3. Troubles on Tone Control Section

- 3-1. Tone control section inoperative ————
1. Defective TR07~TR10 on F-2554

7-4. Troubles on Equalizer Section

- 4-1. Equalizer section inoperative ————
1. Imperfect contact of selector switch, S01
 2. Defective TR01~TR06 on F-2555

8. PACKIG LIST

Parts No.	Stock No.	Description
1	9116640	Vinyl Cover
2	9027800	Styrofoam Packing
3	9009050	Carton Case
4	5996080	Curl Stopper

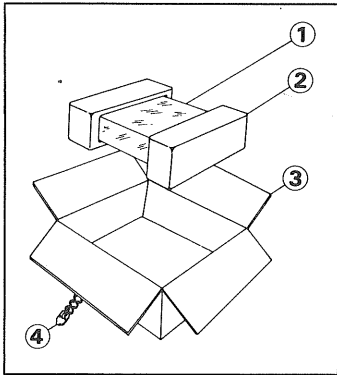

9. ACCESSORY PARTS LIST

Stock No.	Description
9209660	Operating Instructions
9237350	Schematic Diagram



SANSUI ELECTRIC CO., LTD.
14-1, 2-chome, Izumi, Suginamiku, Tokyo 168, Japan
TELEPHONE: (03) 323-1111 / TELEX: 232-2076

4. PARTS LOCATION AND PARTS LIST

4-1. F-2555 Tone Control Circuit Board (Stock No. 7561431)

Conductor Side

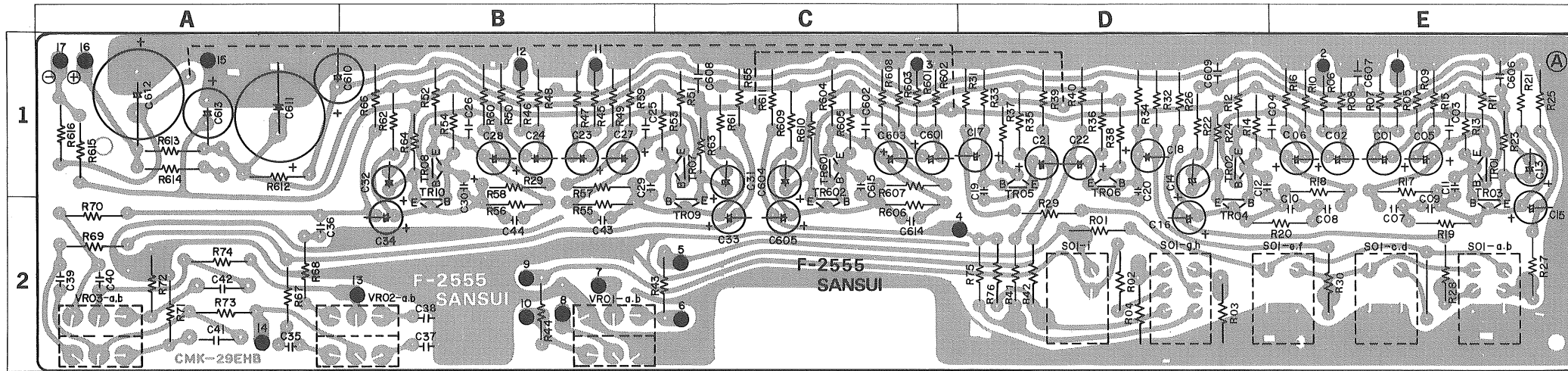

Parts List (F-2555)

Parts No.	Stock No.	Description	Position
TR01, 02	0300470, 1	2SA726 (F, G)	} Transistor
TR03, 04	0306070, 1	2SC1313 (F)	
TR05, 06	0300470, 1	2SA726 (F, G)	
TR07, 08	0300470, 1	2SA726 (F, G)	
TR09, 10	0306070, 1	2SC1313 (F, G)	
VR01	1015070, 1	100kΩ (M, N) × 2	2 B
VR02	1015080, 1	100kΩ (A) × 2	2 A, B
VR03	1015080, 1	100kΩ (A) × 2	2 A
S01	1131120	SUB54 Push Switch	2 D, E

4-2. F-2554 Driver Circuit Board (Stock No. 7571371)

Conductor Side

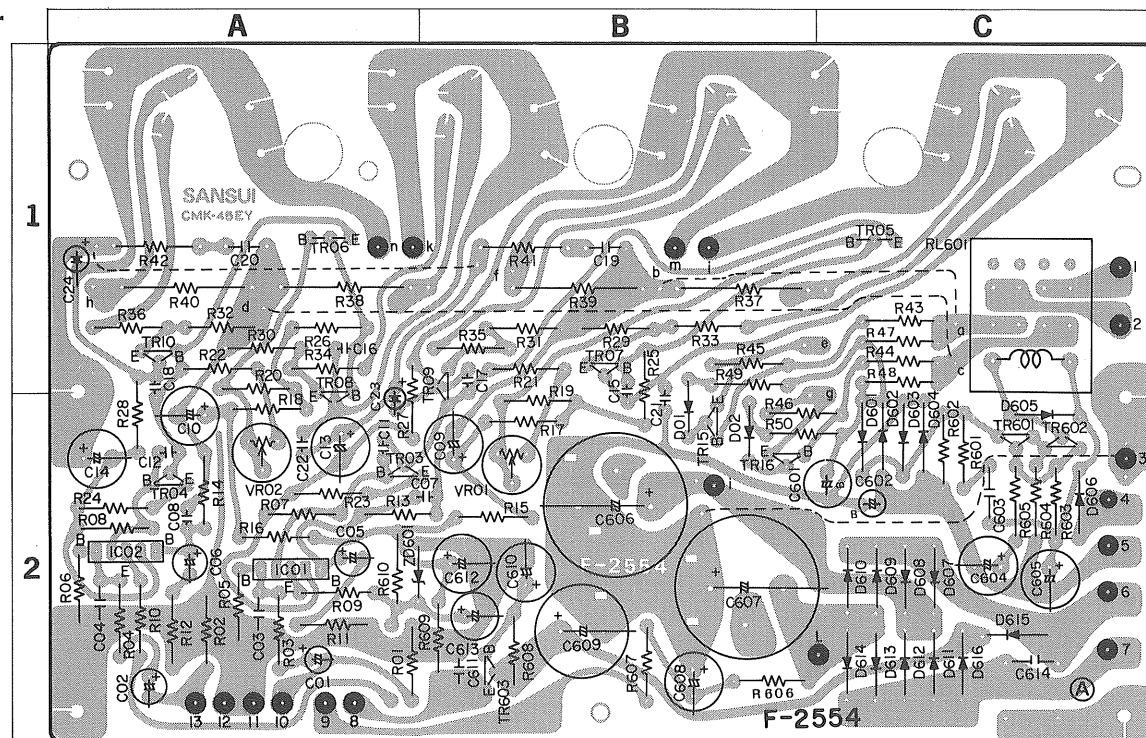

Parts List (F-2554)

Parts No.	Stock No.	Description	Position
TR03, 04	0306370, 1	2SC1175V10(D, E)	} Transistor
TR05, 06	0305731	2SC711 (E)	
TR07, 08	0305930, 1	2SC1211 (C, D)	
TR09, 10	0300310, 1	2SA697 (C, D)	
TR11, 12	0308411, 2	2SD314 (D, E)	
TR13, 14	0303420, 1	2SB508 (D, E)	
TR603	0306132, 3	2SC1364 (7, 8)	2 B
IC01, 02	0360290, 1	2SA798 (F, G)	2 A
D607	0310340	10D1 (1S2226)	} Diode
D609	0310340	10D1 (1S2226)	
D611	0310340	10D1 (1S2226)	
D613	0310340	10D1 (1S2226)	
D615	0310340	10D1 (1S2226)	
D616	0310340	10D1 (1S2226)	
ZD601	0315970	EQA01-13R Zener Diode	2 A, B
C606	0549007	3300μF } 50V E.C.	} 2 B
C607	0549007	3300μF	
C614	0655103	10000pF 500V C.C.	
R37, 38	0132338	0.33Ω } 2 W Ce.R.	} 1 B. 1 A
R39, 40	0132338	0.33Ω	
R41, 42	0210479	4.7Ω 1/2 W M.C.	1 B. 1 A
R901	0103182	1.8kΩ 1/4 W C.R.	
VR01, 02	1035050	470Ω Semi-Variable Resistor	2 B. 2 A

4-3. F-2556 Switch Circuit Board (Stock No. 7594041)

Conductor Side

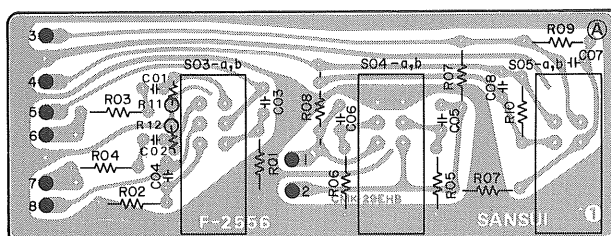

Parts List (F-2556)

Parts No.	Stock No.	Description
C01, 02	0621561	560 pF 50V P.C.
S03	1170340	S × 15-1
S04	1170350	S × 15-2

} Lever Switch

4-4. F-2587 Connector Circuit Board (Stock No. 7594051)

Conductor Side

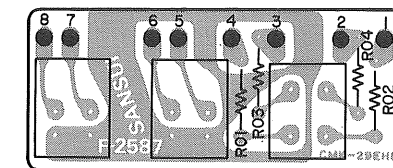

4-5. Figures

SEMICONDUCTORS	COMPLETE CIRCUIT BOARD	SEMICONDUCTORS	COMPLETE CIRCUIT BOARD
2SA726 2SC1313 2SC711 2SC1211 2SA697 2SC1175	F-2555 F-2554	2SC1364	F-2554
2SD314 2SB508	F-2554	2SA798	F-2554

Abbreviations

C.R. : Carbon Resistor	BP.E.C.: Bi-Polar Electrolytic Capacitor
S.R. : Solid Resistor	C.C. : Ceramic Capacitor
Ce.R. : Cement Resistor	Mi.C. : Mica Capacitor
M.R. : Metallized Film Resistor	O.C. : Oil Capacitor
M.C. : Mylar Capacitor	P.C. : Polystyrene Capacitor
E.C. : Electrolytic Capacitor	T.C. : Tantalum Capacitor

*Value and Stock No. of most Resistors and Capacitors are shown in Common Parts List attached.

5. SCHEMATIC DIAGRAM

* La présentation et les spécifications sont susceptibles d'être modifiées sans préavis par suites d'améliorations éventuelles.
 * Änderungen, die dem technischen Fortschritt dienen, bleiben vorbehalten.
 * Design and specifications subject to change without notice for improvements.

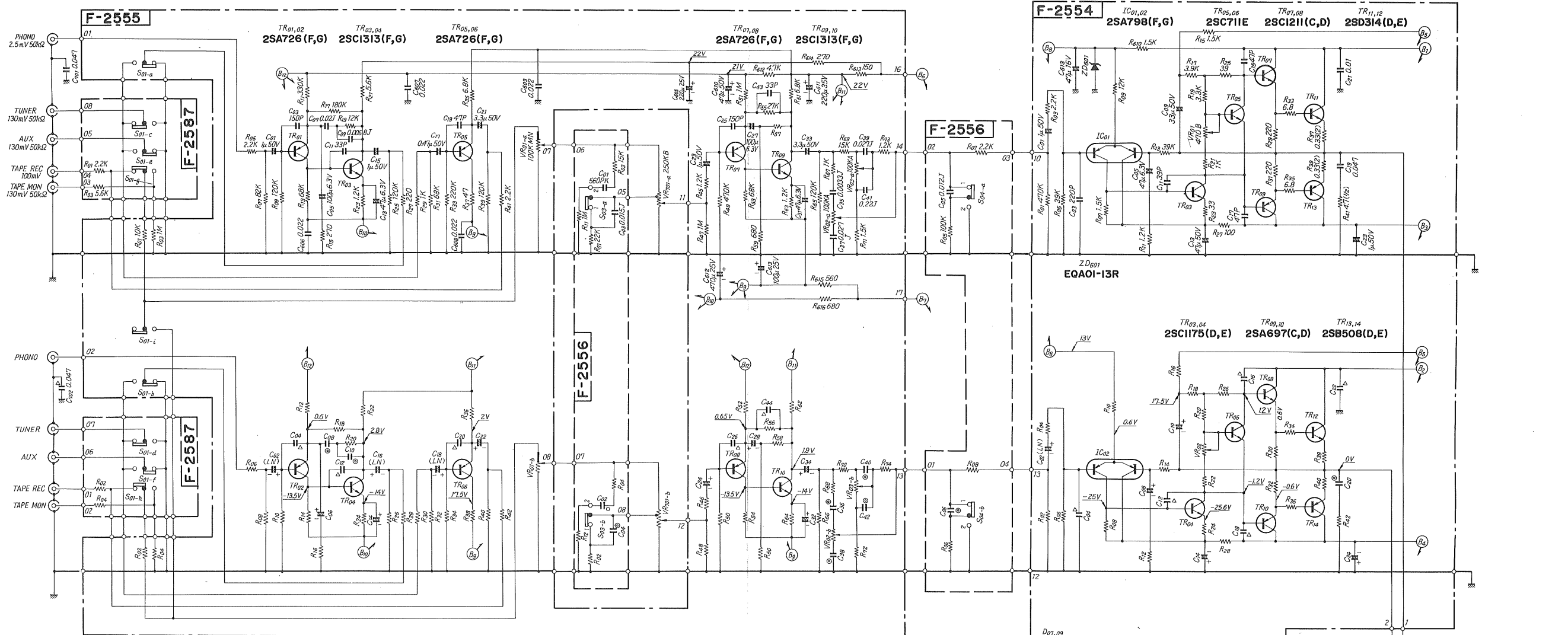

- SELECTOR S01-a-f
 1. PHONO S01-a,b
 2. TUNER S01-c,d
 3. AUX S01-e,f
- TAPE MONITOR S01-g,h
 1. SOURCE S01-g
 2. PLAYBACK S01-h
- MODE S01-i
 1. STEREO S01-i
 2. MONO S01-j
- LOUDNESS S03-a,b
 1. OUT S03-a
 2. IN S03-b
- HIGH FILTER S04-a,b
 1. OUT S04-a
 2. IN S04-b
- POWER SPEAKERS S05-a-e
 1. POWER OFF S05-a
 2. A S05-b
 3. SPEAKER OFF S05-c
 4. B S05-d
 5. A+B S05-e
- BALANCE VOLUME VR01-a,b
 VR01-a,b
 VR01-b

