

OPERATING INSTRUCTIONS & SERVICE MANUAL

AM/FM STEREO AMPLIFIER

SANSUI AU-7500

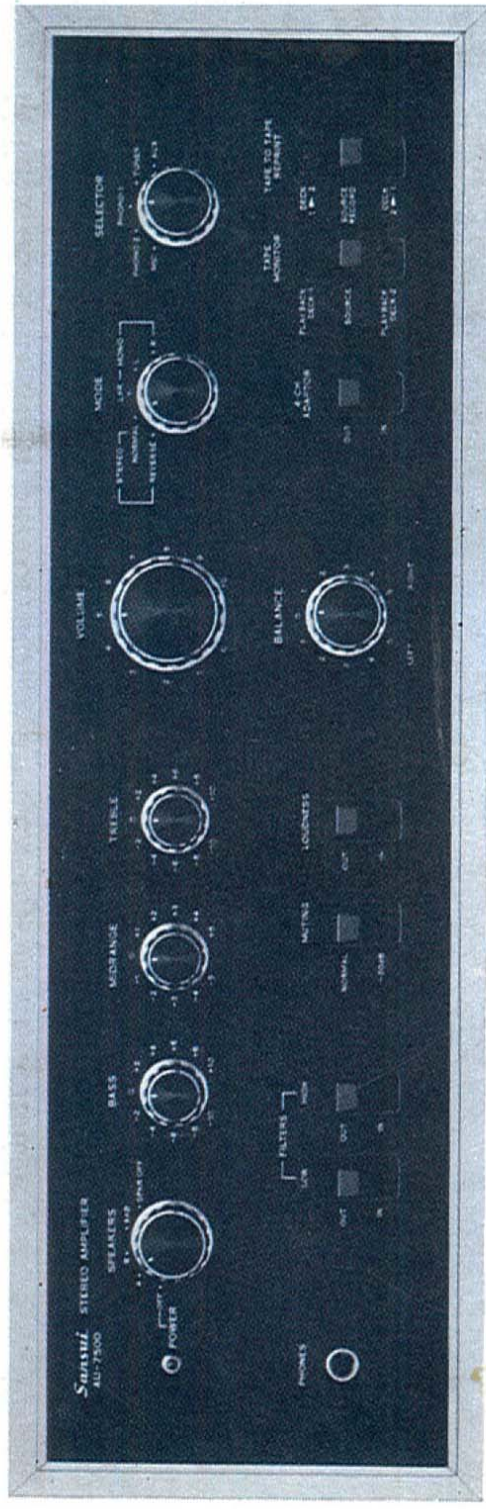

Sansui

SANSUI ELECTRIC CO., LTD.

We are grateful for your choice of the AU-7500 Integrated Amplifier.

For over a quarter of a century, Sansui has been building hi-fi audio equipment, and nothing else. Our mission is very old and at once ever new to us: to bring the reproduced sound closer and closer to the original.

The AU-7500 now in your hands is one answer from us to this never-ending quest. It is a product of the cream of sophisticated modern audio-electronics knowhow, coupled with our long experience, and as such, we present it to you with our full confidence. The AU-7500 is a new breed of Sansui's AU series integrated amplifiers. Its tone quality has been polished and perfected through an unprecedented number of listening tests in different acoustic environments. We feel certain that you will like it, but you will find this out as soon as you play your first record through it.

This manual has been prepared to guide you in operating and caring for the amplifier correctly, so that you will get the most out of its built-in high performance and exceptional versatility.

May we suggest that you read it once carefully?

CONTENTS

SWITCHES AND CONTROLS	3, 4
SETTING UP YOUR AU-7500/ OPERATING PROCEDURE	5, 6
RECORDING AND PLAYBACK BY TAPE DECKS.....	7
UPGRADING YOUR STEREO (4-CHANNEL STEREO SYSTEM/ELECTRONIC CROSSOVER SYSTEM)	8
SIMPLE MAINTENANCE HINTS/ACCESSORY LIST ...	9, 10
QUICK CHECK LIST OF SIMPLE MISTAKES.....	11
SPECIFICATIONS	12
SCHEMATIC DIAGRAM	13, 14
NOTES TO SERVICE ENGINEERS	15
GENERAL TROUBLESHOOTING CHART	16
DISASSEMBLY PROCEDURE	17
ALIGNMENT	18
PRINTED CIRCUIT BOARDS AND PARTS LIST.....	19~24
OTHER PARTS AND THEIR POSITION ON CHASSIS...	25, 26

SOUND BY STEREO AMPLIFIER
A-17500

STEREO SPEAKERS

SELECTOR
PHONO
TUNER

MODE
STEREO
LP - MONO

VOLUME

BASS

MIDRANGE

TREBLE

BALANCE

TAPE MONITOR
TAPE TO TAPE
REPRINT

TAPE MONITOR
PLAYERS
RECORDS

TAPE MONITOR
RECORDS
PLAYERS

LOGGERS

METER

FLUORESCENT
LUM

PHONES

LISTEN

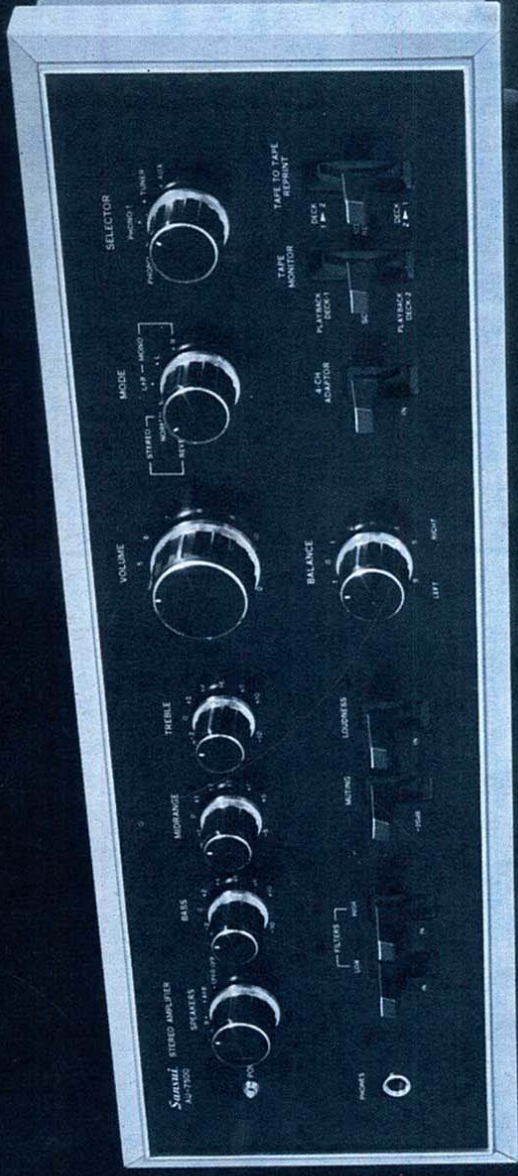

SWITCHES AND CONTROLS

Power Indicator

Lights when you turn on the Power/Speakers Switch, and remains lit until you turn off the switch.

Power/Speakers Switch

Controls both the power supply and selection of speaker systems.

POWER OFF: Cuts off power supply for the amplifier.

A: Turns on power supply and energizes the speaker systems connected to SYSTEM-A speaker terminals on the rear. Because of the builtin amplifier/speaker protection circuit, sound will come out with a delay of a few seconds.

B: Energizes speaker systems connected to SYSTEM-B speaker terminals.

A+B: Energizes both A and B pairs of speaker systems.

SPKR OFF: Cuts off the sound from all speaker systems to permit private listening with headphones connected to the Headphone Jack.

Headphone Jack

Plug stereo headphones into this jack for private listening or monitoring, but be sure to turn the Power/Speakers Switch to SPKR OFF first unless someone is listening to the sound from speaker systems in another room. The jack will accept any standard stereo phone plug, but for best tone quality, we recommend a dynamic type such as the Sansui SS-20 or SS-10.

Filters

Low: Push down to IN to eliminate low-frequency noise such as the rumbling of your turntable motor. If no such noise is present, be sure to keep it off.

High: Push down to IN to eliminate high-frequency noise such as the surface noise from a worn record or as the fluorescent lamp noise mixed in radio broadcasts.

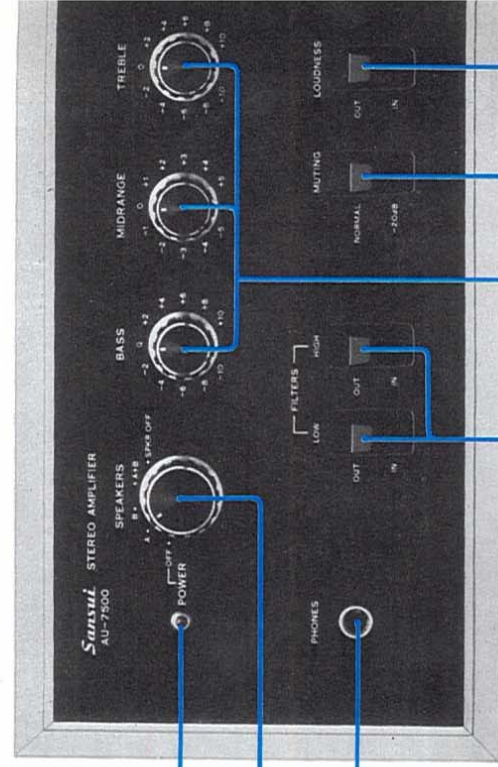

Triple Tone Controls

Let you tailor the tone quality of reproduced sound to your taste by adjusting the amplifier's frequency response curve. The Bass Control is for adjusting the loudness of bass notes as may be produced by a bass; the Midrange one for adjusting that of middle range notes as may be produced by the human voice, and the Treble one for adjusting that of treble notes as may be produced by cymbals.

Muting Switch

Reduces the sound volume by 20dB at once without the use of the Volume Control. Most convenient to lower the sound volume temporarily when the telephone rings, to avoid the noise of the pickup stylus descending on a record, etc.

Loudness Switch

If desired, push down to IN to emphasize the highs and lows when listening at low volume levels. This is because the mechanism of human hearing is such that the high and low notes seem greatly enfeebled at low listening levels.

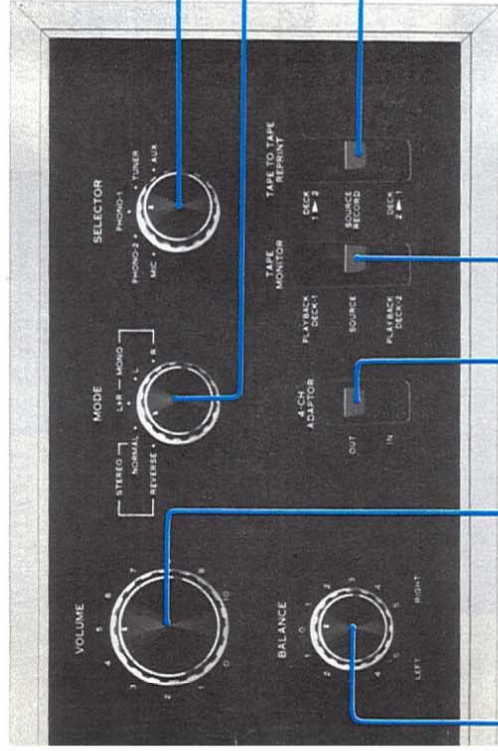

Selector Control

Turn to an appropriate position to hear the desired program source.

MIC: To use microphones (high impedance type of 10 kilo-ohms or more) plugged into the Mic Jacks on the rear.

PHONO-2, PHONO-1: To play records on a turntable connected to the PHONO 2 or 1 terminals on the rear. The input impedance of the PHONO-2 circuit is adjustable with the rear-panel Pickup Load Switch to match the load impedance of the cartridge in use.

TUNER: To hear a radio broadcast from a tuner connected to the TUNER terminals on the rear.

AUX: To reproduce whatever program source is connected to the AUX terminals on the rear. (Connect a turntable with a crystal or ceramic cartridge, the audio outputs of a television, the playback outputs of a tape recorder, etc. to the AUX terminals.)

Mode Switch

STEREO: The NORMAL position is normal. If you have connected the left and right speaker systems in reverse, set this switch to REVERSE to restore the normal stereo effect without physically changing the speaker connections.

MONO: Set to L+R, and the monophonic mixture of the left and right channel signals is heard from both speaker systems. Set to L(R), and only the left (right) channel signal is heard from both speaker systems.

Tape-to-Tape Reprint Switch

If you have two tape decks connected to the amplifier, you can copy a recorded tape from one to the other.

DECK 1 > 2: To record from the tape deck connected to the TAPE DECK-1 terminals on the rear to the one connected to the TAPE DECK-2 terminals.

DECK 2 > 1: Reverse of the above.

SOURCE RECORD: To record or play on one tape deck alone. When neither of the above procedures is desired, keep the switch in this position.

Volume Control

Tape Monitor Switch

The AU-7500 connects two tape decks at a time. Set this switch to PLAYBACK DECK-1 or PLAYBACK DECK-2 to reproduce a recorded tape or monitor a recording as you make it on a tape deck connected to the amplifier (monitoring is possible only if the tape deck is equipped with separate recording and playback heads). Otherwise, be sure to keep it at SOURCE.

4-Channel Adaptor Switch

If you connect a 4-channel adaptor to the AU-7500 and make other necessary connections, you can upgrade this 2-channel stereo amplifier to hear 4-channel stereo sound by pushing this switch down to IN (refer to page 8).

Balance Control

Set the Mode Switch to MONO L+R once and adjust this control for equal sound volume from the left and right speaker systems, then return the switch to STEREO NORMAL. If there is a large difference in the sound volumes from the two speaker systems even with this control set near the center, it may be because left and right output signal levels from the program source component (turntable, tuner, tape deck, etc.) are different. Check the component once.

SETTING UP YOUR AU-7500 / OPERATING PROCEDURE

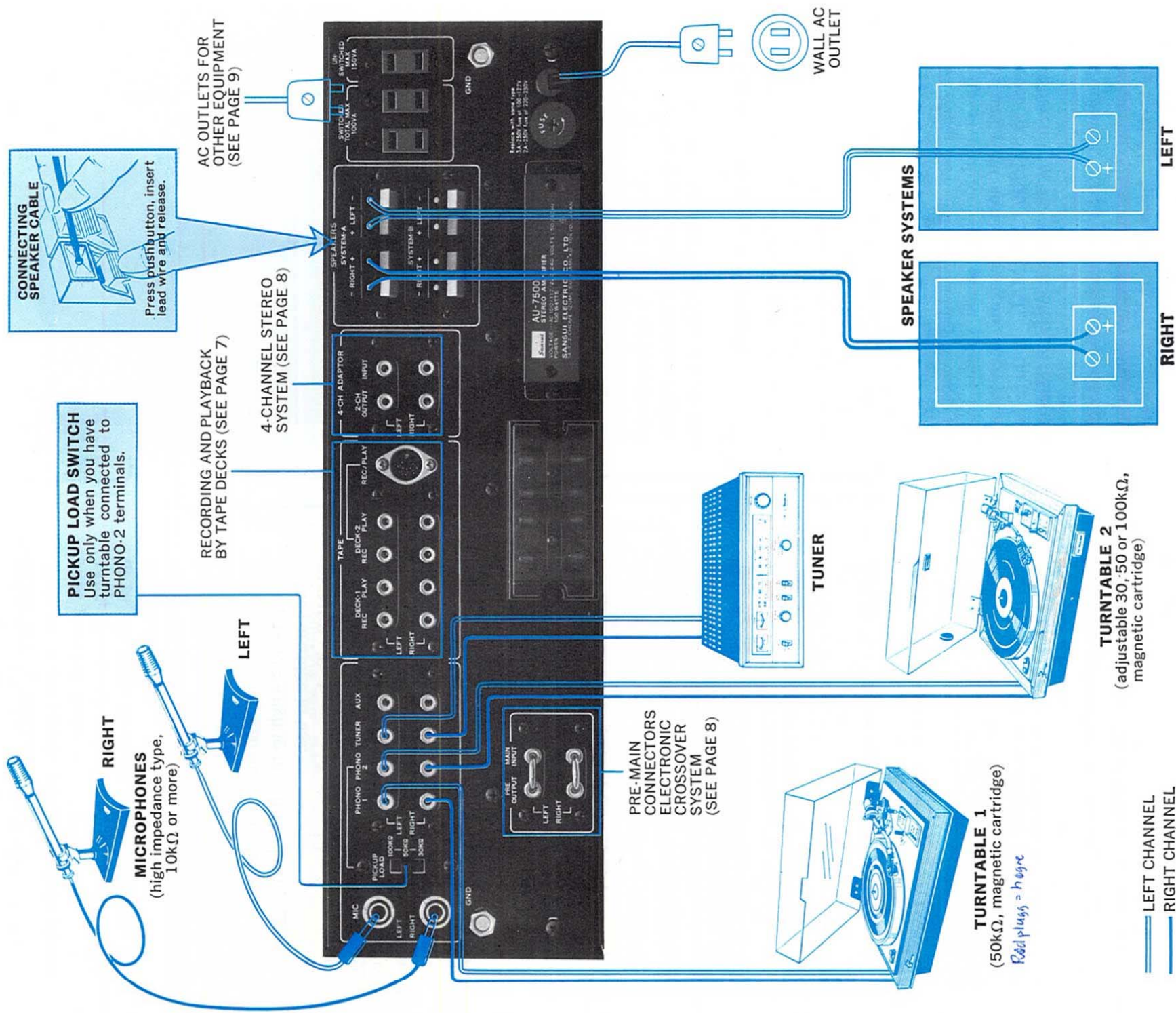

RECORDING AND PLAYBACK BY TAPE DECKS

Connecting Tape Decks

The AU-7500 connects up to two tape decks for recording and playback. Connect the input terminals of a tape deck to either TAPE DECK-1 or 2 REC terminals of the amplifier, and its output terminals to the PLAY terminals of the same circuit. The DIN socket is a part of the TAPE DECK-2 circuit and can be used only if your tape deck is equipped with a similar socket. It is manufactured according to the German industrial standard to permit tape recording and playback from a single cable with a special 5-pin plug on each end. Should you wish to connect more than two tape decks, you may connect it to the 4-CH ADAPTOR terminals. The OUTPUT terminals have the same electrical function as the REC terminals, while the INPUT terminals are equivalent to the PLAY terminals.

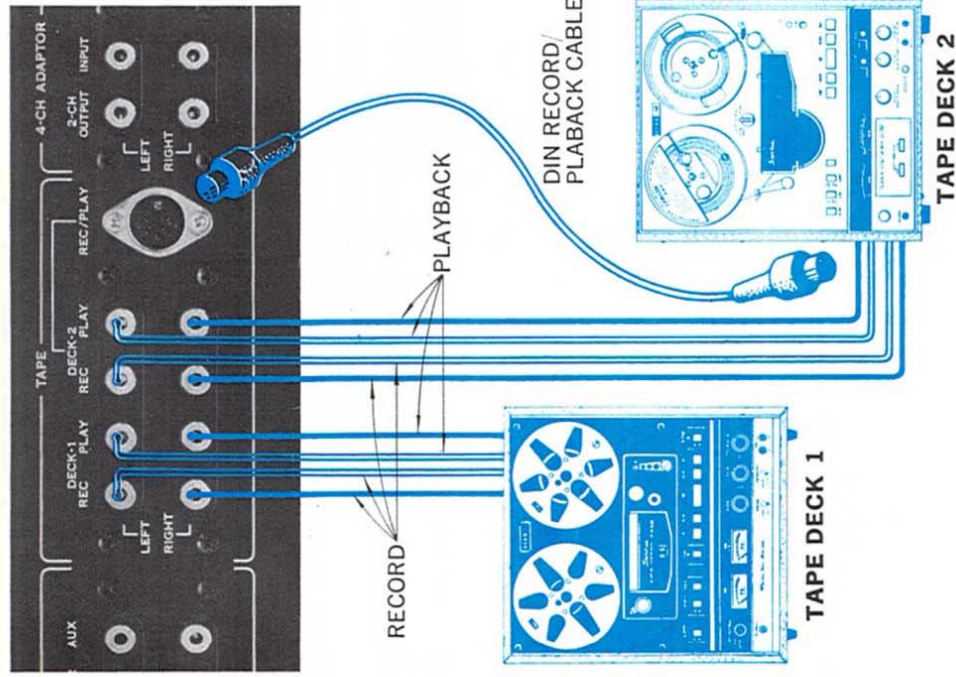

NOTE: Do not connect tape deck(s) to pin jack terminals and DIN socket of TAPE DECK-2 circuit simultaneously.

— LEFT CHANNEL
— RIGHT CHANNEL

Recording & Playback Procedure

Recording

1. Set the Selector Control to the program source you wish to record.
2. Adjust the recording volume control of the tape deck to preset the recording level.
3. Start the tape deck in the recording mode.
4. To monitor, follow the same procedure as indicated in the section entitled 'Playback'.

Playback

1. Set the Tape Monitor Switch to PLAYBACK DECK-1 or 2.
2. Start the tape deck in the playback mode.
3. Use the amplifier's other switches and controls to suit your taste and room acoustics.

Procedure for Copying a Recorded Tape

Depending on which tape deck you wish to use for recording, set the Tape-to-Tape Reprint Switch correctly. That is, if you are copying from the tape deck connected to the TAPE DECK-1 terminals to the one connected to the TAPE DECK-2 terminals, set it to DECK 1▶2. If you want to do it the other way around, set it to DECK 2▶1.

By operating the Tape Monitor Switch, you can monitor the recording as you copy it from one tape deck to the other. Set the switch to the tape deck you are using to reproduce, and you can monitor the recording before it is copied. Set it to the tape deck you are using to record, and you can monitor the recording after it is copied.

Notes about Recording

1. Monitoring of recorded sound is possible only if the recording tape deck is equipped with separate heads for recording and playback. Otherwise, set the Tape Monitor Switch to SOURCE and listen to the original input sound before it is recorded.
2. The various switches and controls on the AU-7500 do not affect the sound recorded into the tape deck. They only adjust the sound from the speaker systems or headphones.
3. When copying a recorded tape from one tape deck to the other, setting the Tape Monitor Switch to SOURCE electrically separates the tape record/playback circuits from the rest of the amplifier. You can use the amplifier to play records or hear radio broadcasts while the copying is underway.

UPGRADING YOUR STEREO

4-Channel Stereo System

The sound we hear daily is a mixture of the sound that reaches our ears straight from the sound source—be it a musical instrument, a jet, a man's mouth or what have you—and the 'indirect sounds' that arrive at your ears only after they are reflected off various surfaces, such as the walls, ceiling and so forth.

Four-channel recordings are made using two microphones in the front of the concert hall and two in the rear (to simplify the explanation). The 'indirect sounds' with their complicated waveforms are mainly picked up by the two microphones in the rear, and reproduced out of the two rear speakers in a 4-channel stereo set-up for greatly enhanced 'ambience' effects. The effect is almost as if the original live performance were re-played right in your own room. This new approach can now be yours simply by adding certain equipment—mainly, a Sansui 4-channel rear amplifier with its unique QS (RM) synthesizer decoder matrix (patents pending), and a second pair of speaker systems—to your 2-channel stereo system.

Connection of such a rear amplifier or 4-channel adaptor is easy. Just connect the 4-CH ADAPTOR 2-CH OUTPUT terminals of the AU-7500 with the input terminals of such rear amplifier or 4-channel adaptor, then connect its 4-CH ADAPTOR INPUT terminals with the output terminals of such unit.

To operate the rear amplifier or 4-channel adaptor so connected, push the 4-Channel Adaptor Switch on the amplifier's front panel, and otherwise follow its manufacturer's instructions. Electrically, the 4-CH ADAPTOR 2-CH OUTPUT and INPUT terminals possess the same functions as the TAPE REC and MON terminals, respectively.

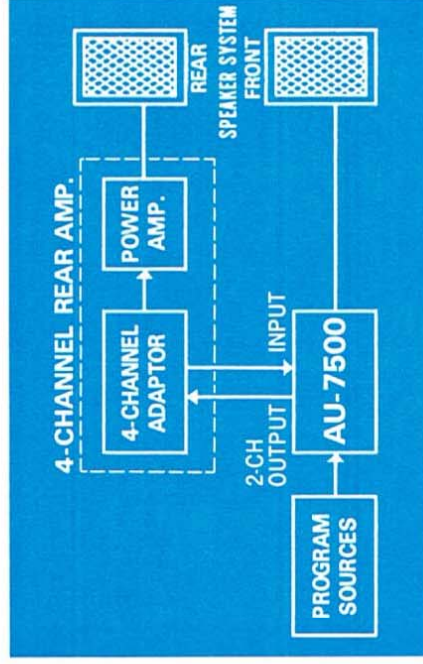

Electronic Crossover System

The electronic crossover system affords these advantages:

1. It enables the tweeters, midranges and woofers to be driven by separate power amplifiers. So you can make optimum use of speakers of different impedances and efficiencies, as well as power amplifiers of different output capacities and tone qualities.
2. It eliminates the need for the conventional LC type crossover network. With the electronic crossover divider, the amplifier's damping factor is no longer affected and you can set crossover frequencies as you like.

Electronic Crossover System Using the AU-7500

The preamplifier and power amplifier sections of the AU-7500 can be disconnected for independent usage, the latter section being available for driving a separate speaker in an electronic crossover system. To build such a system, you will need two- or three-way speaker systems and an electronic crossover divider, along with and at least one or two additional power amplifiers.

Connection is not all that difficult. First remove the Pre-Main Connectors uniting the amplifier's pre-amplifier outputs and main (power) amplifier inputs. Then just connect the PRE OUTPUT to the input terminals of the electronic crossover divider, which divides the input signals into high, medium and low range(s). Finally, couple the separate output terminals of the electronic crossover divider to the amplifier's MAIN INPUT and the additional power amplifier(s), feeding their outputs separately into individual speakers, as illustrated below.

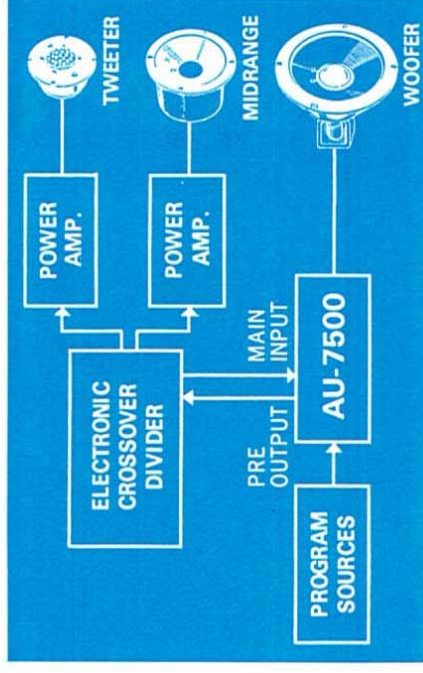

SIMPLE MAINTENANCE HINTS / ACCESSORY LIST

Real-Panel AC Outlets

Of the three AC outlets provided on the rear panel, the ones marked 'SWITCHED' are controlled by the front-panel Power/Speakers Switch. The third one, marked 'UNSWITCHED,' is always 'live' and independent of the Power/Speakers Switch. The voltage delivered at these AC outlets is the same as the power supply voltage used.

The two 'SWITCHED' outlets have a total power capacity of 100VA, and the UNSWITCHED one 150VA. Before you connect any appliance to them, be sure that it is adjusted for use at the same power supply voltage, and that its power consumption is not beyond these figures. Otherwise, serious danger could result.

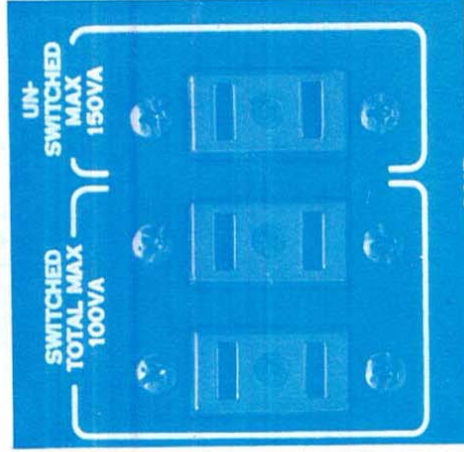

Make Proper Connections

Connect the leadwires of speaker cables properly. If they are loose or touch other parts, the amplifier may produce noise and eventually break down. Also, before connecting a turntable, tuner and/or tape deck, be sure to read their manufacturers' instructions.

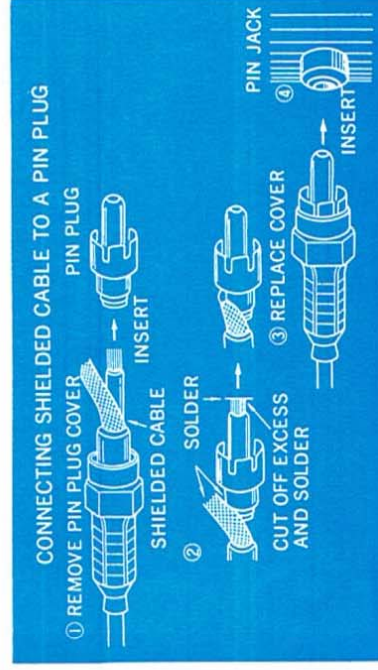

Speaker Impedance

Do not ever connect two pairs of speaker systems with impedance of less than 8 ohms each. Doing so will reduce the composite speaker impedance in each channel to less than 4 ohms, and may cause the quick-acting fuses to blow or result in a more serious breakdown over a long period of time.

Phasing of Speakers

Listen to any monophonic reproduction. If the speaker systems are correctly phased, the sound will seem to come from a point midway between the left and right speaker systems. If the sound is not directly in front of you, however, the speaker systems are out of phase. If you notice this condition, check the speaker connections once. To correct the condition, switch the amplifier off and reverse the connection of plus and minus leadwires of one speaker cable. Also, be careful not to connect a single speaker system between the SYSTEM-A and SYSTEM-B terminals by mistake.

Howling and Hum

Take care never to place a turntable on or too near a speaker system, or the vibration produced by the speaker system is transmitted and causes an oscillating phenomenon called howling. It is best to keep these components completely separated, but if this is impossible, place a thick cushion between them. Humming, in contrast, is a phenomenon caused by incomplete or incorrect turntable-amplifier connections. Should this occur, check to see if all connections are completely made and if the connecting cables are sufficiently thick. Hum noise may sometimes be eliminated by connecting the grounding lead of the turntable to the GND terminal on the amplifier's rear panel.

Voltage Adjustment

Your AU-7500 is adjusted in our factory to operate at the power supply voltage of your area. That voltage is indicated on the amplifier. Should you, after purchasing the amplifier, move to an area where the power supply voltage is different from the one indicated, adjust the amplifier's voltage selector plugs as follows:

1. Remove the two screws securing the name plate on the rear, then remove the name plate.
2. Set the arrow mark on the Main Voltage Selector Plug to the new voltage: 100, 110, 117, 127, 220, 230, 240 or 250 volts.
3. If the new voltage is indicated in red, set the arrow mark on the adjacent Sub Voltage Selector Plug to "RED". If it is indicated in white, however, set that arrow to "WHITE".
4. Change the power fuse as well whenever the power supply voltage has changed. For 100—127 volt operation, use a 3-ampere glass-tubed fuse. For 220—250 volt operation, use a 2-ampere one.
5. Where the power supply voltage considerably fluctuates, the Main Voltage Selector Plug may be reset to avoid unpleasant side effects of such fluctuation. Reset it to the voltage immediately higher than the peak of the fluctuation.

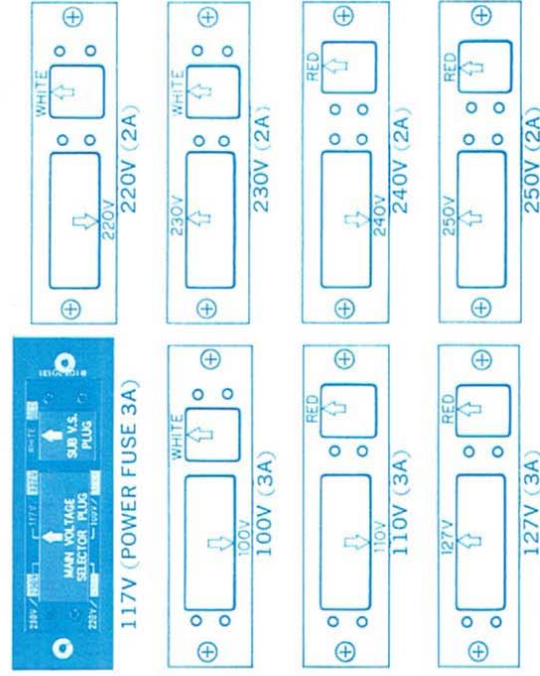

Heat Radiated inside the Amplifier

The bonnet of the AU-7500 is designed so that any heat radiated inside will effectively escape through it. Proper care should therefore be taken of the dissipation of such heat if you wish to place something on top of the amplifier or place it inside a closed box, etc. Above all, avoid placing it where it may be exposed to the direct sunlight.

It is prohibited, however, to remove the amplifier's bonnet or bottom plate to improve the ventilation.

Accessory List

1. OPERATING INSTRUCTIONS AND SERVICE MANUAL 1
2. OPERATING INSTRUCTIONS SHEET 1
3. PIN PLUGS 4
4. BUTTERFLY BOLTS 2
5. WASHERS 2
6. POLISHING CLOTH 1
7. QUICK-ACTING FUSES (4A)..... 2

QUICK CHECK LIST OF SIMPLE MISTAKES

Some of the troubles which seem to result from a malfunction of the amplifier are caused by wrong operation and the negligence of simple maintenance, and can be quickly corrected by making a simple investigation and providing simple cures. To make sure you haven't made any of these mistakes, go over the following check list once.

Connections

1. Have you connected the power cord to a wall AC outlet?
2. Are the connecting cables for the turntable and tape deck not loose?
3. Are the speaker cables not loose from the amplifier's jacks or the speaker systems?
4. Do your speaker systems have impedance of 8 ohms or more? (They must, if you want to drive two pairs at one time.)
5. Have the power fuse or quick-acting fuses not blown?

Operating Procedure

1. Have you turned on the Power/Speakers Switch?
2. Is the Tape Monitor Switch not set to PLAY-BACK position, though you don't want to reproduce a tape?
3. Is the Selector Control set to the correct position?
4. Is the Power/Speakers Switch set to the correct position?
5. Is the 4-Channel Adaptor Switch not pushed down, though you are not using a 4-channel rear amplifier or adaptor?

If, even after these examinations, the amplifier does not return to normal, it may be faulty. Contact the Sansui dealer from whom you purchased the amplifier or your nearest Sansui Authorized Service Station. Do not attempt opening the bonnet for yourself. Such repair must be left to a qualified service man.

Should the Power Fuse Blow

If the amplifier simply remains dead even after you have turned on its Power/Speakers Switch, it is possible that its power fuse has blown.

If this happens, switch off the amplifier, disconnect the power cord from the wall AC outlet at once and examine the power fuse on the amplifier's rear panel. If you find it blown, replace it with a new glass-tubed fuse of the rated capacity (3-ampere for 100 to 127 volts, 2-ampere for 220 to 250 volts). Never use a fuse of a different capacity or a piece of wire, even as a stop-gap measure, or serious danger could result.



Quick-Acting Fuses

The AU-7500 is doubly protected with a relay-equipped protection circuit and four quick-acting fuses. If no sound or distorted sound is heard from either or both speaker systems, switch off the amplifier, disconnect the power cord from the wall AC outlet, remove the cover on the rear panel concealing the quick-acting fuses and examine them. If you find any of them blown, find and eliminate the cause of the blowout, then replace it with a new glass-tubed quick-acting fuse supplied.

If the relay-equipped protection circuit ever goes to work, the sound may come out intermittently. If it happens, check the connections of various equipment and your operating procedure once.

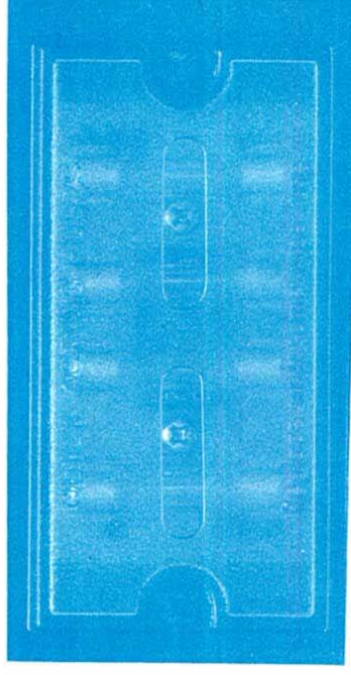

SPECIFICATIONS

POWER OUTPUT:

- IHF MUSIC POWER 150W (4 Ω , 1,000Hz)
- CONTINUOUS RMS POWER (each channel driven) 43/43W (4 Ω , 1,000Hz)
- CONTINUOUS RMS POWER (both channels driven) 40+40W (8 Ω , 1,000Hz)
- CONTINUOUS RMS POWER (both channels driven at rated distortion, 20 to 20,000Hz) 32+32W (8 Ω)

TOTAL HARMONIC DISTORTION:

less than 0.1% at rated output

INTERMODULATION DISTORTION

(70Hz : 7,000Hz=4 : 1 SMPTE method):

less than 0.1% at rated output

IHF POWER BANDWIDTH (each channel driven at 8 Ω):

5 to 40,000Hz

FREQUENCY RESPONSE (at 1 watt power output):

PHONO-1 and 2

RIAA equalization curve

± 0.5 dB (30 to 15,000Hz)

OVER-ALL (from AUX) 10 to 30,000Hz ± 1.0 dB

MAIN INPUT 10 to 50,000Hz ± 1.0 dB

LOAD IMPEDANCE:

4 to 16 ohms

DAMPING FACTOR:

approx. 40 at 8 ohms load

INPUT SENSITIVITY AND IMPEDANCE (at 1,000Hz):

PHONO-1 2.5mV (50k Ω)

PHONO-2 2.5mV (30k Ω , 50k Ω , 100k Ω)

Max. Input Capability 300mV (THD: less than 0.5%)

MIC 2.5mV (50k Ω)

TUNER 100mV (50k Ω)

AUX 100mV (50k Ω)

TAPE DECK-1 and 2 (Pin)

100mV (50k Ω)

TAPE DECK-2 (DIN) 100mV (50k Ω)

4-CH ADAPTOR 100mV (50k Ω)

MAIN INPUT 800mV (40k Ω)

OUTPUT VOLTAGE (at 1,000Hz):

TAPE DECK-1 and 2 (Pin) 100mV

TAPE DECK-2 (DIN) 30mV

4-CH ADAPTOR 100mV

PRE-OUTPUT 0.8V (THD: less than 0.08%)

Max. Output Voltage 4.0V (THD: less than 0.5%)

CROSSTALK (at rated output, 1,000Hz):

PHONO-1 and 2

better than 50dB

MIC

better than 50dB

TUNER

better than 50dB

AUX

better than 50dB

MAIN INPUT

better than 65dB

IHF HUM AND NOISE:

PHONO-1

better than 75dB

PHONO-2

MIC

better than 75dB

TUNER

better than 75dB

AUX

better than 80dB

MAIN INPUT

better than 80dB

CONTROLS & SWITCHES:

BASS

+15dB, -15dB at 50Hz

MIDRANGE

+5dB, -5dB at 1,500Hz

TREBLE

+15dB, -15dB at 15,000Hz

LOUDNESS

+10dB at 50Hz,

+10dB at 15,000Hz

(volume control at -30dB)

LOW FILTER

-12dB at 50Hz (12dB/oct)

HIGH FILTER

-11dB at 10,000Hz (12dB/oct)

SEMICONDUCTORS:

transistors 38, diodes 15

zener diode 1

POWER REQUIREMENTS:

100, 110, 117, 127, 220 30, 2,

240, 250V, 50/60Hz

POWER CONSUMPTION:

MAXIMUM 315VA

RATED 100W

DIMENSIONS:

140mm (5 $\frac{9}{16}$ ") H

440mm (17 $\frac{3}{8}$ ") W

322mm (12 $\frac{1}{16}$ ") D

WEIGHT:

12.7kg (28.0 lbs.)

SCHEMATIC DIAGRAM

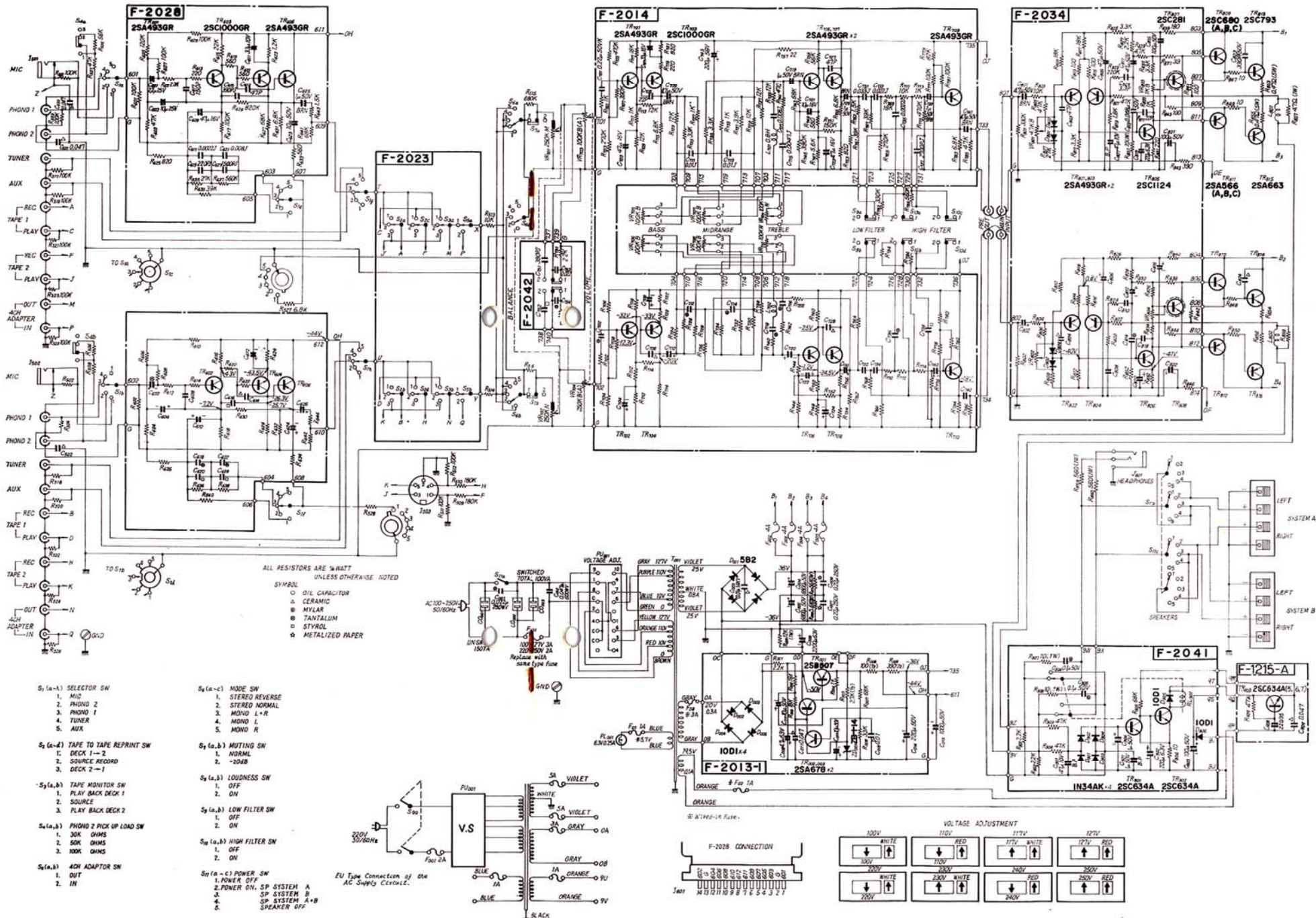

ALL RESISTORS ARE 1/2WATT UNLESS OTHERWISE NOTED

SYMBOL

- OIL CAPACITOR
- △ CERAMIC
- MYLAR
- TANTALUM
- STYROL
- ★ METALIZED PAPER

- S₁ (a-1) SELECTOR SW**
- MIC
 - PHONO 2
 - PHONO 1
 - TUNER
 - AUX
- S₂ (a-4) TAPE TO TAPE REPRINT SW**
- DECK 1 — 2
 - SOURCE RECORD
 - DECK 2 — 1
- S₃ (a, b) TAPE MONITOR SW**
- PLAY BACK DECK 1
 - SOURCE
 - PLAY BACK DECK 2
- S₄ (a, b) PHONO 2 PICK UP LOAD SW**
- 30K OHMS
 - 50K OHMS
 - 100K OHMS
- S₅ (a, b) 4OH ADAPTOR SW**
- OUT
 - IN
- S₆ (a-c) MODE SW**
- STEREO REVERSE
 - STEREO NORMAL
 - MONO L-R
 - MONO L
 - MONO R
- S₇ (a, b) MUTING SW**
- NORML
 - 20dB
- S₈ (a, b) LOUDNESS SW**
- OFF
 - ON
- S₉ (a, b) LOW FILTER SW**
- OFF
 - ON
- S₁₀ (a, b) HIGH FILTER SW**
- OFF
 - ON
- S₁₁ (a-c) POWER SW**
- POWER OFF
 - POWER ON, SP SYSTEM A
 - POWER ON, SP SYSTEM B
 - SP SYSTEM A+B
 - SPEAKER OFF

EU Type Connector of the AC Supply Cord.

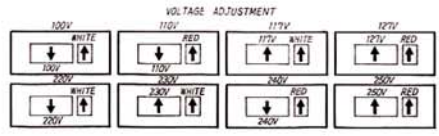

NOTES TO SERVICE ENGINEERS

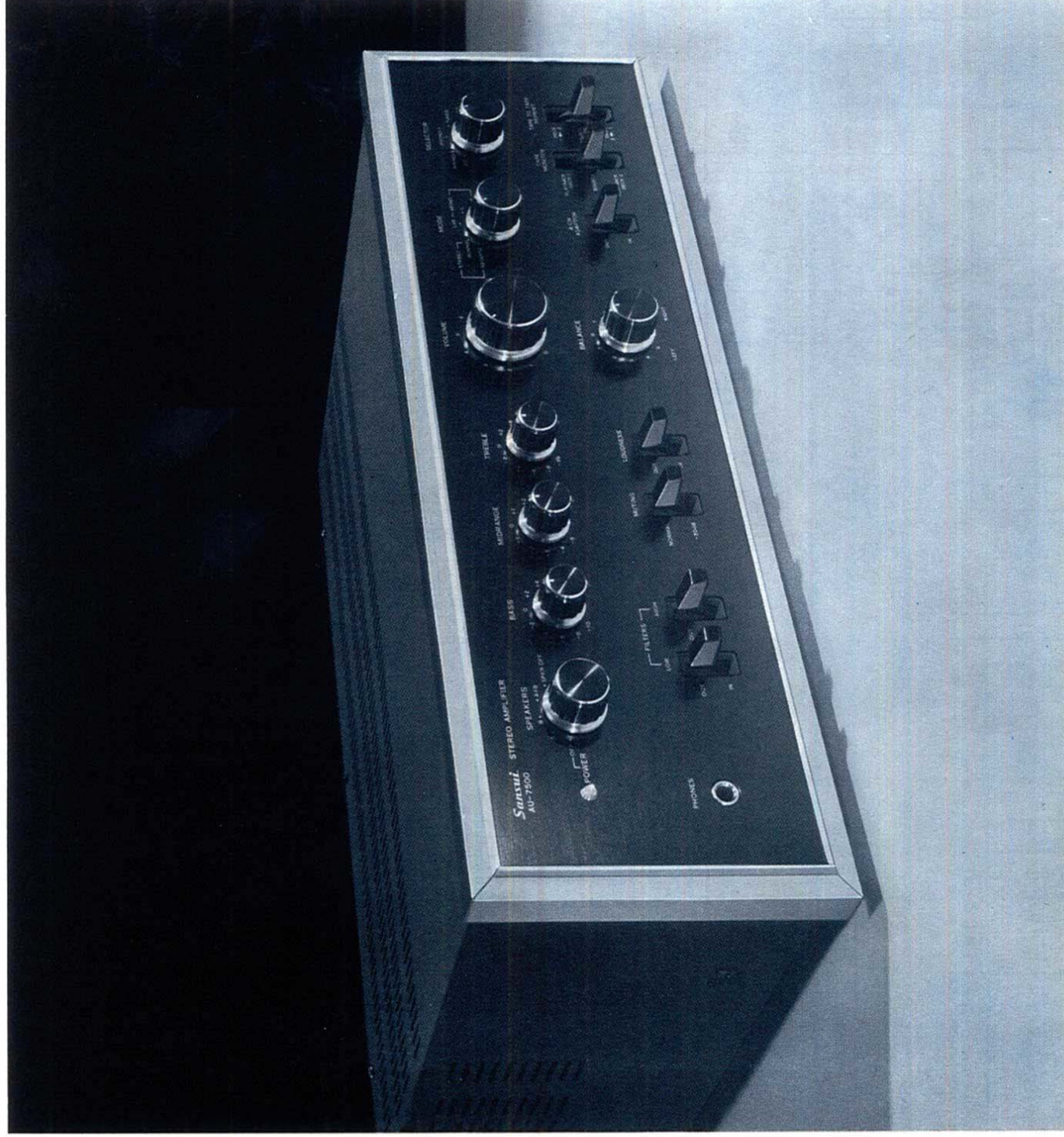

■ Please contact the nearest Sansui Authorized Service Station for replacement parts. When ordering them, look up the part lists on pages 19 to 26 and let us know (1) the amplifier's model number, (2) name of the printed circuit board, (3) part No., (4) name of the part, and (5) its stock No. Using nonstandard parts for temporary relief often impairs the sound quality and over-all reliability of the amplifier. Please take the trouble to contact your nearest Sansui Authorized Service Station.

■ Consult pages 17 to 26 when making repairs or adjustments. To check or measure the amplifier performance, connect a load resistance of 4 to 16 ohms to the amplifier's speaker output terminals first. To check the electrical output characteristics, do not remove the bonnet and bottom plate.

GENERAL TROUBLESHOOTING CHART

PROGRAM SOURCE	SYMPTOM	PROBABLE CAUSE	WHAT TO DO
Tuner.	* Noise during AM reception.	<ul style="list-style-type: none"> * Interference by adjacent stations (called beat interference). * TV set is being used simultaneously. * Interference by nearby electrical appliances. 	<ul style="list-style-type: none"> * Peculiar to AM waves, and unavoidable to some extent. * Move TV set away from tuner and amplifier. * Attach noise limiter to appliance producing noise. * In some cases, can be eliminated by reversing power cord plug-AC outlet connections.
	* Noise heard at certain hours, in certain areas or over part of dial during AM reception.	<ul style="list-style-type: none"> * Ignition noise from nearby automobile, motorcycle, etc. 	<ul style="list-style-type: none"> * Adjust antenna location and height for maximum sensitivity. * Keep antenna away from streets.
	* Pop noise during FM reception.	<p>Note: In many cases, high-frequency noise during radio reception cannot be entirely eliminated. Try turning on amplifier's High Filter Switch or turning Treble Control counterclockwise.</p>	
Turntable.	* Hum noise.	<ul style="list-style-type: none"> * Unshielded cables used to connect turntable. * Minus (ground) wire of connecting cable is not connected completely. * Turntable motor or tonearm is not grounded. 	<ul style="list-style-type: none"> * Use regular shielded cables. * Examine connecting cables, especially their plugs. * Connect grounding lead of turntable to amplifier's GND terminal.
	* Loud oscillating noise.	<ul style="list-style-type: none"> * Turntable is placed on top of or too close to speaker systems. 	<ul style="list-style-type: none"> * Place thick cushion between turntable and speaker systems. * Change location of turntable and speaker systems. * If using microphone(s), move or direct them away from speaker systems
	* Sound is shaky.	<ul style="list-style-type: none"> * Dust on record or pickup stylus. * Worn pickup stylus. * Improper stylus pressure. 	<ul style="list-style-type: none"> * Clean record and pickup stylus. * Replace pickup stylus. * Adjust stylus pressure.
Tape Deck.	* Hiss noise.	<ul style="list-style-type: none"> * Magnetic heads are magnetized. 	<ul style="list-style-type: none"> * Demagnetize heads. * Turn on High Filter Switch. * Connect noise reduction adaptor.
	* Sound is not clear.	<ul style="list-style-type: none"> * Dust on magnetic heads. * Tape is not pressed tight to heads. 	<ul style="list-style-type: none"> * Clean heads. * Align tape transport mechanism.
	* When left and right channel sound volumes are balanced with amplifier's Balance Control, it does not come to center position.	<ul style="list-style-type: none"> * Left and right channel signal strengths vary with program source. * Left and right speaker systems have different efficiencies. 	<ul style="list-style-type: none"> * Never mind. Optimum stereo effect is obtained by adjusting Balance Control so that sound comes from midway point between two speaker systems with Mode Switch set to MONO L+R.
General.	* Musical instruments and singer not located clearly.	<ul style="list-style-type: none"> * Left-right, plus-minus connections of speaker systems, input cables are wrong. 	<ul style="list-style-type: none"> * Examine connections once.
	* Want to listen at very low volume level at night.	<ul style="list-style-type: none"> * Fine adjustment of very low volume cannot be done with Volume Control. 	<ul style="list-style-type: none"> * Turn on Muting Switch, then adjust Volume Control.

DISASSEMBLY PROCEDURE

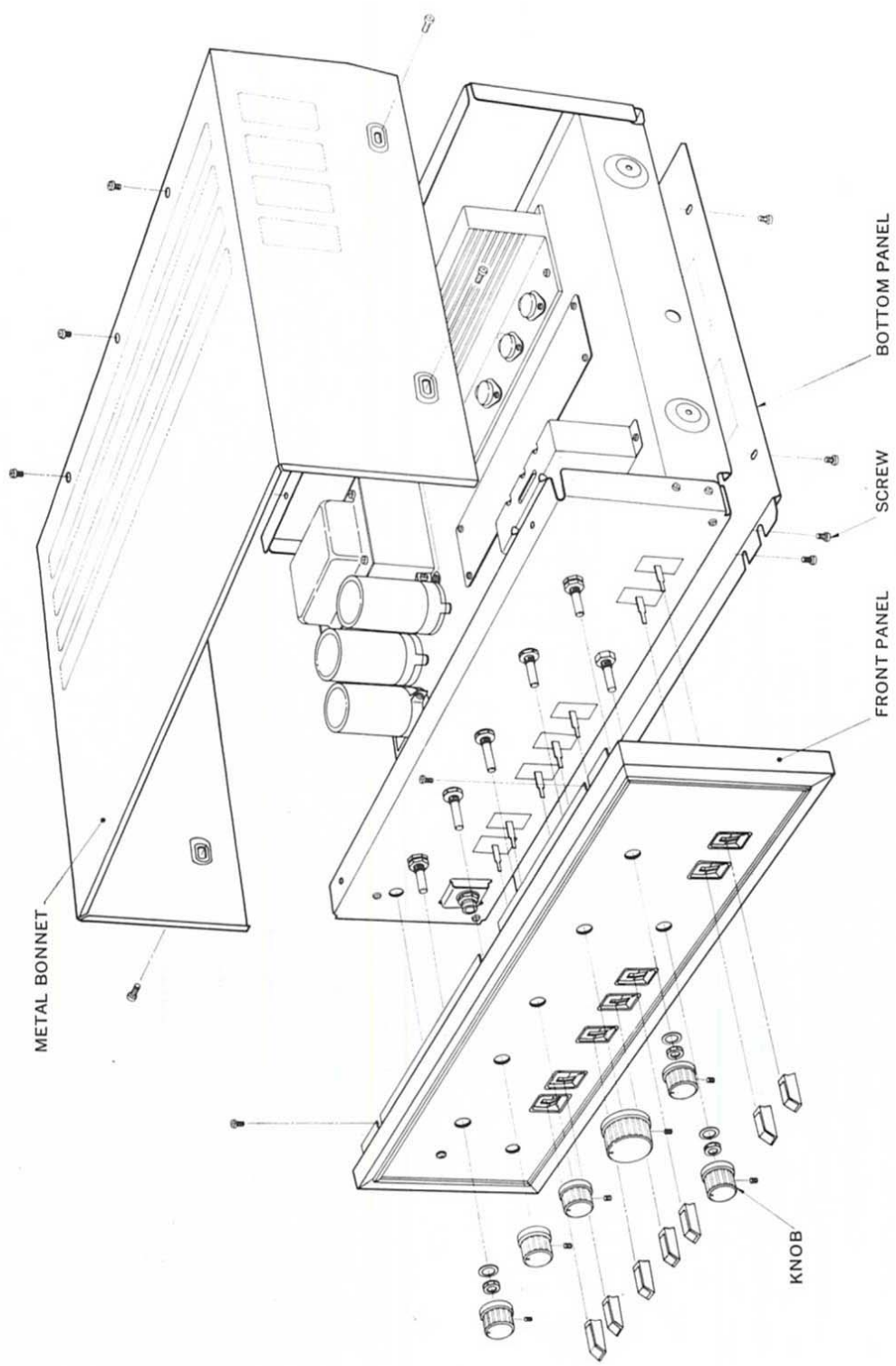

ALIGNMENT

Output of Power Amplifier Section

STEP	CONNECT/ADJUST	REMARKS
1.	Connect load resistance (8 to 16 ohms) to left (right) channel SYSTEM-A speaker terminals.	
2.	Connect voltmeter in parallel with load resistance.	Set voltmeter to 0.5V~3V range.
3.	Turn Power/Speakers Switch to SYSTEM-A.	
4.	Adjust VR ₈₀₁ (VR ₈₀₂) so that voltmeter indicates 0±50mA. Repeat above procedure for right channel (notations in parentheses are for right channel).	

Current Alignment of Power Amplifier Section

STEP	AMMETER (TESTER)	CONNECT/ADJUST	REMARKS
1.		Remove F ₀₀₂ and F ₀₀₃ .	
2.		Turn VR ₈₀₃ and VR ₈₀₄ fully counterclockwise.	Use ammeter with 100mA or 50mA range.
3.		Turn Power/Speakers Switch to SPKR OFF.	
4.	Set to 100mA range.	Connect ammeter where F ₀₀₂ was. (Connect (21) on schematic to minus terminal of ammeter, other end to plus terminal.)	
5.		Adjust VR ₈₀₃ (left channel) so that ammeter indicates 28 to 32mA.	
6.		Turn off Power/Speakers Switch and replace F ₀₀₂ .	
7.	Set to 100mA range.	Turn Power/Speakers Switch to SPKR OFF, then connect ammeter where F ₀₀₃ was. (Connect (22) on circuit schematic to minus terminal of ammeter, other end to plus terminal.)	
8.		Adjust VR ₈₀₄ (right channel) so that ammeter indicates 28 to 32mA.	
9.		Turn off Power/Speakers Switch and replace F ₀₀₃ .	

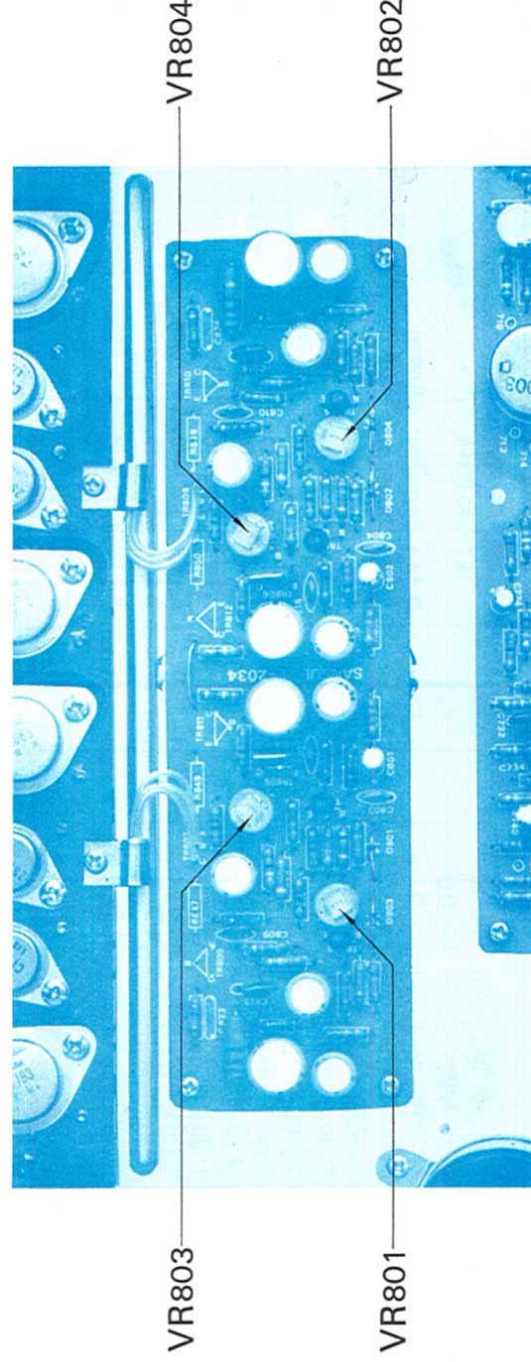

PRINTED CIRCUIT BOARDS AND PARTS LIST

W: Parts No. X: Parts Name Y: Stock No. Z: Position of Parts

DRIVER BLOCK <F-2034>

Stock No. 7570670

W	X	Y	Z
R801	±10% 1/4W CR.	0101334	2 B
R802		0101334	2 B
R803		0101103	2 B
R804		0101103	2 B
R805		0101473	2 A
R806		0101473	2 C
R807		0101273	2 A, B
R808		0101273	2 B, C
R809		0101183	2 A
R810		0101183	2 C
R811		0101332	2 A
R812		0101332	2 C
R813		0101101	2 A
R814		0101101	2 C
R815		0101101	2 A
R816		0101101	2 C
R817		0101183	2 A
R818		0101183	2 C
R819		0101182	2 A
R820		0101182	2 C
R821		0101473	1, 2 A
R822		0101473	1, 2 C
R823		0101224	1, 2 A
R824		0101224	1, 2 C
R825	0101332	2 A	
R826	0101332	2 C	
R827	0101222	1, 2 A	
R828	0101222	1, 2 C	
R829	0101472	1, 2 A	
R830	0101472	1, 2 C	
R831	0101221	2 B	
R832	0101221	2 B	
R833	0101102	1 B	
R834	0101102	1 B	
R835	0101332	2 A, B	
R836	0101332	2 B, C	
R837	39Ω	1 A	
R838	39Ω	1 C	
R839	180Ω	1 A	
R840	180Ω	1 C	
R841	100Ω	1 A	
R842	100Ω	1 C	
R843	100Ω	1 A, B	
R844	100Ω	1 B, C	
R845	390Ω	1 B	
R846	390Ω	1 B	
R851	10Ω	1 A	
R852	10Ω	1 C	
VR801	4.7kΩ(B)	1035110	2 A
VR802	4.7kΩ(B)	1035110	2 C
VR803	1kΩ(B)	1035070	1 A, B
VR804	1kΩ(B)	1035070	1 B, C
C801	4.7μF	0519106	2 B
C802	4.7μF	0519106	2 B

W	X	Y	Z		
C803	47μF	±10%	50V CC.		
C804				0660470	2 B
C805	47μF	±10%	50V EC.		
C806				0515470	2 A
C807	47μF	±10%	10V BPEC.		
C808				0531470	2 A
C809	3.3pF	±10%	50V CC.		
C810				0660339	1 A
C811	47μF	±10%	50V EC.		
C812				0515470	1 A
C813	0.068μF	±10%	50V MC.		
C814				0601687	1 A
C815	100μF	±10%	50V EC.		
C816				0515101	1, 2 A
C817	22pF	±10%	50V CC.		
C818				0660220	2 B
C819	220μF	±10%	6.3V EC.		
C820				0660220	2 B
C821	100μF	±10%	50V EC.		
C822				0510221	2 B
TR801	2SA493 (GR)	±10%	50V EC.		
TR802				0515101	1, 2 A
TR803				0515101	1, 2 C
TR804				0660220	2 B
TR805	2SC1124 (2, 3)	±10%	50V EC.		
TR806				0660220	2 B
TR807	2SC281 (B, C)	±10%	50V EC.		
TR808				0510221	2 B
D801	1S1555	±10%	50V EC.		
D802				0515101	1, 2 B
D803				0515101	1, 2 B
D804				0305121, 2	1 A
			0305121, 2	1 C	
			0300450	2 B	
			0300450	2 B	
			0300450	2 A	
			0300450	2 C	
			0305901, 2	1, 2 B	
			0305901, 2	1, 2 B	
			0305121, 2	1 A	
			0305121, 2	1 C	
			0311040	2 A	
			0311040	2 C	
			0311040	2 A	
			0311040	2 C	
			2570460		

Printed Circuit Board F-2034

Abbreviations

- CR : Carbon Resistor
- SR : Solid Resistor
- CeR : Cement Resistor
- MFR : Metal Oxide Film Resistor
- CC : Ceramic Capacitor
- EC : Electrolytic Capacitor
- SC : Polystyrene Capacitor
- MC : Mylar Capacitor
- MPC : Metallized Polyester Capacitor
- BPEC: Bipolar Electrolytic Capacitor
- TC : Tantalum Capacitor
- OC : Oil Capacitor
- MP : Metal Paper Film Capacitor

PROTECTOR BLOCK

Stock No. 7591230

<F-2041>

Stock No- 7591300

<F-1215A>

W	X	Y	Z
R001	2.2kΩ	0101222	B
R902	2.2kΩ	0101222	A
R903	47kΩ	0101473	A
R904	47kΩ	0101473	A
R905	68kΩ	0101683	B
R906	10Ω	0101100	B
R907	10Ω	0171100	A
R908	10Ω	0171100	A
R909	22kΩ	0107223	3C
R910	47kΩ	0107473	3C
C901	47 μF	0531470	B
C902	220 μF	0510221	B
C903	100 μF	0515101	B
C904	0.1 μF	0601108	A
C905	0.1 μF	0601108	A
C906	1 μF	0515109	B
C907	1 μF	0535109	B
C908	220 μF	0514222	3C
C909	0.047 μF	0657473	3C
TR901	25C634A (6, 7, 8)	0305891,2,3	B
TR902		0305891,2,3	B
TR903	25C634A (5, 6, 7)	0305890,1,2	3C
D901	IN34A (K)	0310402	B
D902		0310402	B
D903		0310402	B
D904		0310402	B
D905	10D-1	0310340	B
D906		0310340	B
RL901	Relay	1150101	A
	Printed Circuit Board	F-2041	
		F-1215	

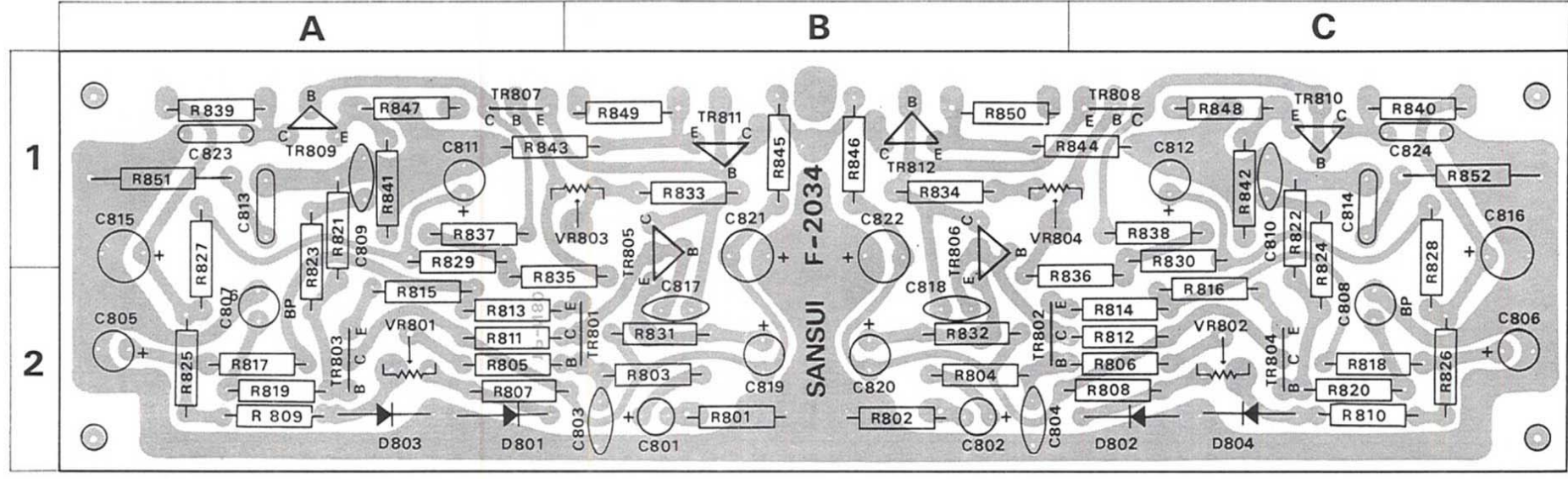
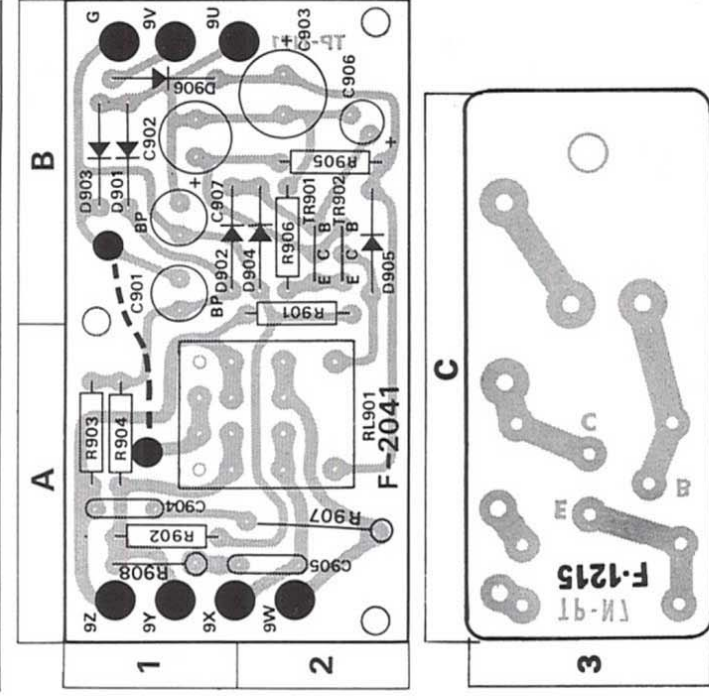

PRINTED CIRCUIT BOARDS AND PARTS LIST

W: Parts No. X: Parts Name Y: Stock No. Z: Position of Parts

PHONE CONTROL BLOCK <F-2014>

Stock No. 7560570

W	X	Y	Z
R701	1kΩ	0101102	2A
R702	1kΩ	0101102	1A
R703	270kΩ	0101274	2A
R704	270kΩ	0101274	1A
R705	470kΩ	0101474	2A
R706	470kΩ	0101474	1A
R707	390kΩ	0101394	2A
R708	390kΩ	0101394	1A
R709	12kΩ	0101123	2A
R710	12kΩ	0101123	1A
R711	1kΩ	0101102	2A
R712	1kΩ	0101102	1A
R713	12kΩ	0101123	2A
R714	12kΩ	0101123	1A
R715	6.8kΩ	0101682	2A
R716	6.8kΩ	0101682	1A
R717	18kΩ	0101183	2A
R718	18kΩ	0101183	1A
R719	220Ω	0101221	2A
R720	220Ω	0101221	1A
R721	820Ω	0101821	2A
R722	820Ω	0101821	1A
R723	12kΩ	0101123	2A
R724	12kΩ	0101123	1A
R725	3.9kΩ	0101392	2A
R726	3.9kΩ	0101392	1A
R727	1kΩ	0101102	2A
R728	1kΩ	0101102	1A
R729	12kΩ	0101123	2A, B
R730	12kΩ	0101123	1A, B
R731	3.9kΩ	0101392	2B
R732	3.9kΩ	0101392	1B
R733	1kΩ	0101102	2B
R734	1kΩ	0101102	1B
R735	3.3kΩ	0101332	2A, B
R736	3.3kΩ	0101332	1A, B
R737	12kΩ	0101123	2B
R738	12kΩ	0101123	1B
R739	12kΩ	0101123	2B
R740	12kΩ	0101123	1B
R741	470Ω	0101471	2B
R742	470Ω	0101471	1B
R743	68kΩ	0101683	2B
R744	68kΩ	0101683	1B
R745	390kΩ	0101394	2B
R746	390kΩ	0101394	1B
R747	5.6kΩ	0101562	2B
R748	5.6kΩ	0101562	1B
R749	560Ω	0101561	2B
R750	560Ω	0101561	1B
R751	150kΩ	0101154	2B
R752	150kΩ	0101154	1B
R753	820Ω	0101821	2B, C
R754	820Ω	0101821	1B, C
R755	6.8kΩ	0101682	2C
R756	6.8kΩ	0101682	1C

W	X	Y	Z
R757	22Ω	0101220	2B
R758	22Ω	0101220	1B
R759	56kΩ	0101563	2B, C
R760	56kΩ	0101563	1B, C
R761	39kΩ	0101393	2B, C
R762	39kΩ	0101393	1C
R763	1.5kΩ	0101152	2C
R764	1.5kΩ	0101152	1C
R765	270kΩ	0101274	2C
R766	270kΩ	0101274	1C
R767	39kΩ	0101393	2C
R768	39kΩ	0101393	1C
R769	10kΩ	0101103	2C
R770	10kΩ	0101103	1C
R771	10kΩ	0101103	2C
R772	10kΩ	0101103	1C
R773	1kΩ	0101102	2C
R774	1kΩ	0101102	1C
R775	470kΩ	0101474	2C
R776	470kΩ	0101474	1C
R777	100kΩ	0101104	2C
R778	100kΩ	0101104	1C
R779	82kΩ	0101823	2C
R780	82kΩ	0101823	1C
R781	100kΩ	0101104	2C
R782	100kΩ	0101104	1C
R783	6.8kΩ	0101682	2C
R784	6.8kΩ	0101682	1C
R785	47kΩ	0101473	2C
R786	47kΩ	0101473	1C

W	X	Y	Z
C701	0.22μF	0601228	2A
C702	0.22μF	0601228	1A
C703	47μF	0511470	2A
C704	47μF	0511470	1A
C705	22pF	0660220	2A
C706	22pF	0660220	1A
C707	33μF	0511330	2A
C708	33μF	0511330	1A
C709	4.7μF	0519106	2A
C710	4.7μF	0519106	1A
C711	0.01μF	0600107	2A
C712	0.01μF	0600107	1A
C713	0.01μF	0600107	2A
C714	0.01μF	0600107	1A
C715	0.0047μF	0600476	2B
C716	0.0047μF	0600476	1B
C717	0.008μF	0600806	2B
C718	0.008μF	0600806	1B
C719	1μF	0519101	2B
C720	1μF	0519101	1B
C721	10μF	0512100	2B
C722	10μF	0512100	1B
C723	4.7μF	0519106	2B
C724	4.7μF	0519106	1B

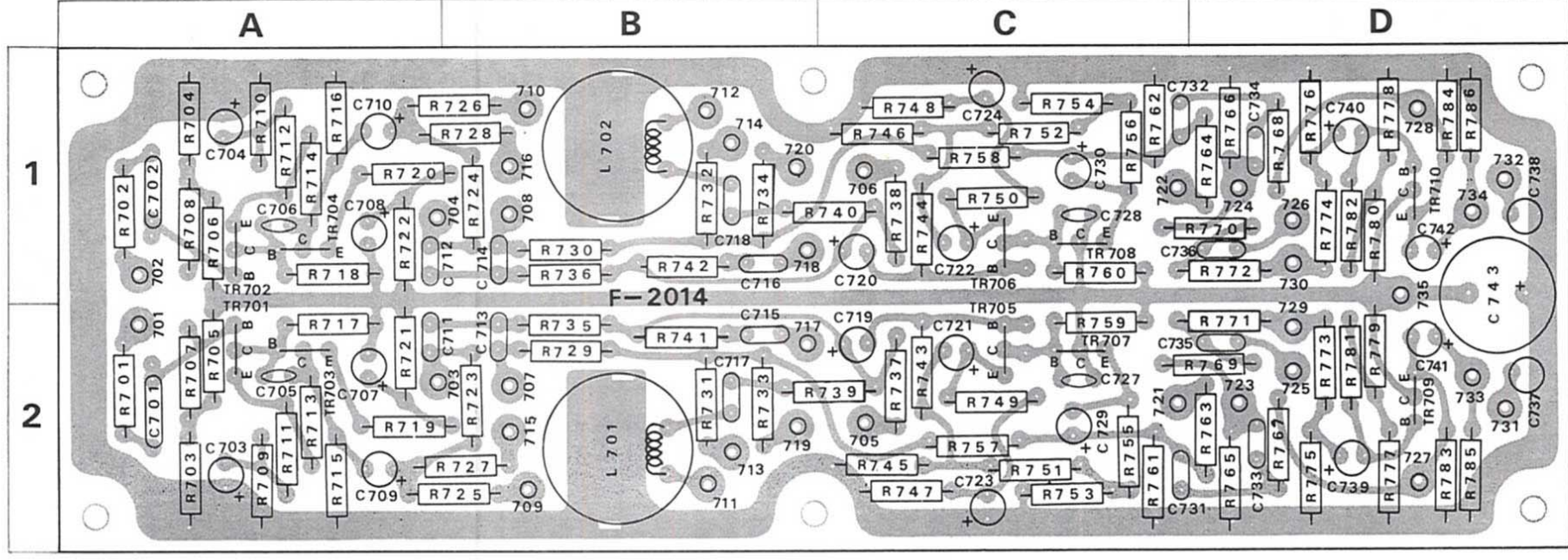

W	X	Y	Z
C727	47pF	0660470	2B, C
C728	47pF	0660470	1B, C
C729	1μF	0519101	2B, C
C730	1μF	0519101	1B, C
C731	0.033μF	0600337	2C
C732	0.033μF	0600337	1C
C733	0.022μF	0600227	2C
C734	0.022μF	0600227	1C
C735	0.0022μF	0600226	2C
C736	0.0022μF	0600226	1C
C737	2700pF	0610272	2C
C738	2700pF	0610272	1C
C739	1μF	0519101	2C
C740	1μF	0519101	1C
C741	4.7μF	0519106	2C
C742	4.7μF	0519106	1C
C743	220μF	0515221	1, 2C
L701	Peaking Coil	4010030	2A, B
TR701	2SA493 (GR)	0300450	1, 2A
TR702	2SA493 (GR)	0300450	1A
TR703	2SC1000 (GR)	0305880	2A
TR704	2SC1000 (GR)	0305880	1A
TR705	2SA493 (GR)	0300450	2B
TR706	2SA493 (GR)	0300450	1B
TR707	2SA493 (GR)	0300450	2C
TR708	2SA493 (GR)	0300450	1C
TR709	2SA493 (GR)	0300450	2C
TR710	2SA493 (GR)	0300450	1C
	Printed Circuit Board	F-2014	
		2560530	

PRINTED CIRCUIT BOARDS AND PARTS LIST

W: Parts No. X: Parts Name Y: Stock No. Z: Position of Parts

EQUALIZER BLOCK <F-2028>

Stock No. 7550420

W	X	Y	Z
R601	100kΩ	0100104	2B
R602	100kΩ	0100104	2A
R603	47kΩ	0100473	1B
R604	47kΩ	0100473	1A
R605	120kΩ	0100124	1B
R606	120kΩ	0100124	1A
R607	100kΩ	0100104	1B
R608	100kΩ	0100104	1A
R609	100kΩ	0100104	1B
R610	100kΩ	0100104	1A
R611	2.2kΩ	0100222	1B
R612	2.2kΩ	0100222	1A
R613	220Ω	0100221	1B
R614	220Ω	0100221	1A
R615	22kΩ	0100223	1, 2B
R616	22kΩ	0100223	1A
R617	100kΩ	0100104	1B
R618	100kΩ	0100104	1A
R619	560Ω	0100561	1B
R620	560Ω	0100561	1A
R621	560Ω	0100561	1, 2B
R622	560Ω	0100561	1, 2A
R623	1.2kΩ	0100122	2B
R624	1.2kΩ	0100122	2A
R625	820Ω	0100821	1B
R626	820Ω	0100821	1A
R627	68kΩ	0100683	1B
R628	68kΩ	0100683	1A
R629	820kΩ	0100824	1, 2B
R630	820kΩ	0100824	1, 2A
R631	6.8kΩ	0100682	2B
R632	6.8kΩ	0100682	2A
R633	560Ω	0100561	2B
R634	560Ω	0100561	2A
R635	27kΩ	0100273	2B
R636	27kΩ	0100273	2A
R637	560kΩ	0100564	2B
R638	560kΩ	0100564	2A
R639	39kΩ	0100393	2A
R640	39kΩ	0100393	2A
R641	68kΩ	0100683	2B
R642	68kΩ	0100683	2A
R643	1.5kΩ	0100152	2B
R644	1.5kΩ	0100152	2A
C601	2.2μF	0573229	1B
C602	2.2μF	0573229	1A
C603	10μF	0513100	1B
C604	10μF	0513100	1A
C607	150pF	0660151	1A
C608	150pF	0660151	1A
C609	47μF	0512470	1B
C610	47μF	0512470	1A
C611	33μF	0511330	2B
C612	33μF	0511330	2A
C613	47pF	0660470	1B

W	X	Y	Z
C614	47pF	0660470	1A
C615	390pF	0610391	2B
C616	390pF	0610391	2A
C617	0.0022μF	0600226	2B
C618	0.0022μF	0600226	2A
C619	220pF	0610221	2B
C620	220pF	0610221	2A
C621	0.008μF	0600806	2B
C622	0.008μF	0600806	2A
C623	10μF	0515100	2B
C624	10μF	0515100	2A
C625	1μF	0519101	2B
C626	1μF	0519101	2A
C627	1500pF	0610152	2B
C628	1500pF	0610152	2A
TR601	2SA493 (GR)	0300450	1B
TR602		0300450	1A
TR603	2SC1000 (GR)	0305880	2B
TR604		0305880	2A
TR605	2SA493 (GR)	0300450	2B
TR606		0300450	2A
	Printed Circuit Board	F-2028	2550330

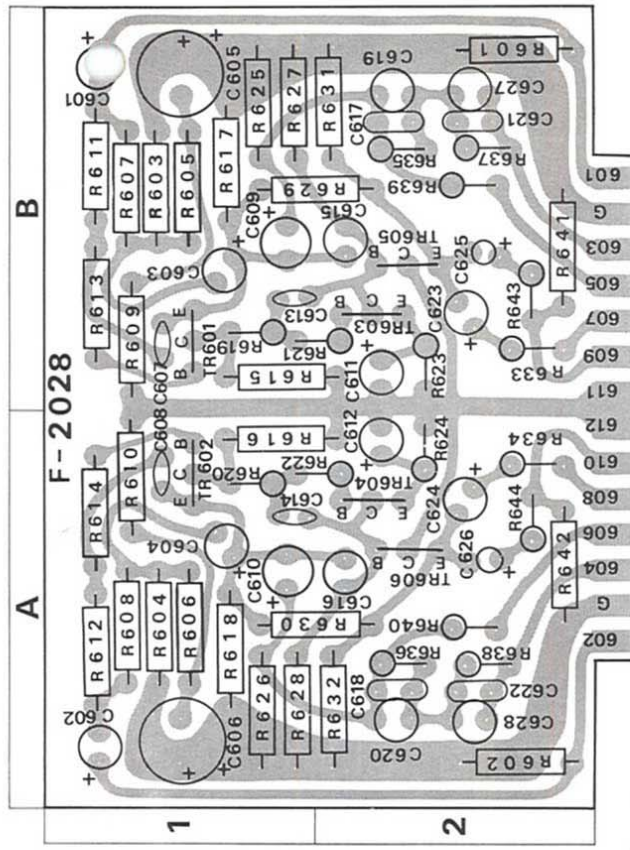

LOUDNESS BLOCK <F-2042>

Stock No. 7591240

W	X	Y	Z
R791	22kΩ } ±10% 1/4W CR.	0101223	
R792		0101223	
C751	390pF } ± 5% 50V SC.	0610391	
C752		0610391	
C753	0.02μF } ± 5% 50V MC.	0600207	
C754		0600207	
Printed Circuit Board F-2042			

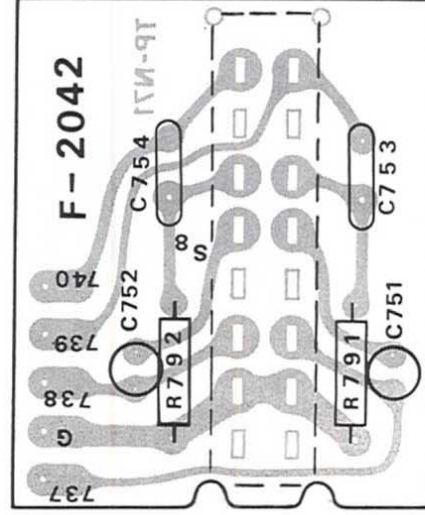

POWER SUPPLY BLOCK <F-2013-1>

Stock No. 7500690

W	X	Y	Z	
R001	2.2kΩ } ±10% 1/4W CR.	0101222	A	
R002		0101183	A	
R003		0101183	B	
R004		0101102	A	
R005		0101272	B	
R006		0101333	B	
R007		0101683	B	
R008		0103101	B	
R009		0103391	B	
C009	4.7μF } 63V EC.	0516479	A	
C010		0515100	A	
C011		0657473	B	
C012		0515100	B	
C013		0515107	B	
C014		0515221	B	
TR001		2SB507 (C, D, E, F)	0303230, 1, 2, 3	A
TR002			0300291, 2, 3	B
TR003			0300291, 2, 3	B
ZD001		ZB-1-14	0315071	B
D002			0310340	A
D003			0310340	A
D004			0310340	A
D005			0310340	A
Printed Circuit Board F-2013-1				

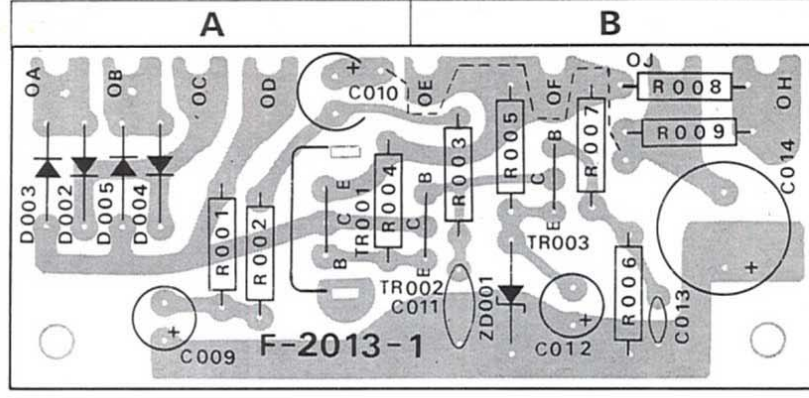

SWITCH BLOCK <F-2023>

Stock No. 2591200

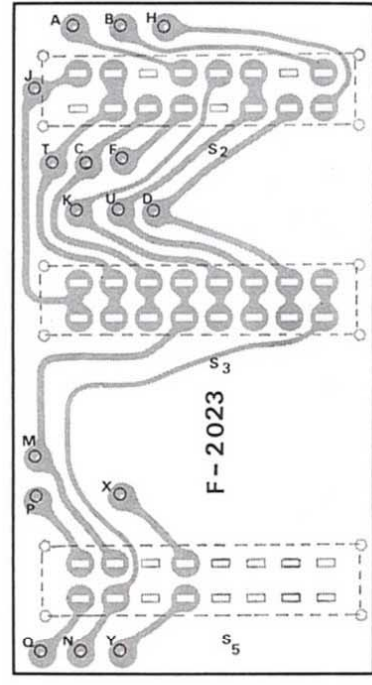

OTHER PARTS AND THEIR POSITION ON CHASSIS

W: Parts No. X: Parts Name Y: Stock No.

W	X	Y	W	X	Y
R501	100kΩ	0101104	C006	0.22μF	0592228
R502	100kΩ	0101104	C007	0.22μF	0592228
R503	100kΩ	0101104	C008	2200μF	0559505
R504	100kΩ	0101104	C011	0.022μF	0605227
R505	56kΩ	0101563	C014	1000μF	0559302
R506	56kΩ	0101563	C501	0.047μF	0660473
R507	47kΩ	0101473	C502	0.047μF	0660473
R508	47kΩ	0101473	C803	0.047μF	0660473
R509	180kΩ	0101184	C823	330pF	0660331
R510	180kΩ	0101184	C824	330pF	0660331
R511	100kΩ	0101104	TR809		0305620,1,2
R512	100kΩ	0101104	TR810	25C680 (A, B, C)	0305620,1,2
R513	10kΩ	0101103	TR811		0300150,1,2
R514	10kΩ	0101103	TR812	25A566 (A, B, C)	0300150,1,2
R515	680kΩ	0101684	TR813		0305450,1,2
R516	680kΩ	0101684	TR814	25C793 (R, Y, BL)	0305450,1,2
R517	100kΩ	0101104	TR815		0300350,1,2
R518	100kΩ	0101104	TR816	25A663 (R, Y, BL)	0300350,1,2
R519	100kΩ	0101104		Power Transistor Socket (Big)	2030020
R520	100kΩ	0101104		Power Transistor Socket (Small)	2030030
R521	100kΩ	0101104	D001	5B2	0310660
R522	100kΩ	0101104	L801		4290221
R523	100kΩ	0101104	L802	Stabilizing Coil for High Frequency Range	4290221
R524	100kΩ	0101104	S1	SELECTOR	1105130
R525	100kΩ	0101104	S2	TAPE TO TAPE REPRINT	1170290
R526	100kΩ	0101104	S3	TAPE MONITOR	1170290
R527	6.8kΩ	0107682	S4	PHONO 2 PICK-UP LOAD	1110110
R528	6.8kΩ	0107682	S5	4CH ADAPTOR	1170300
R793	330kΩ	0101334	S6	MODE SWITCH	1101190
R794	330kΩ	0101334	S7	MUTING	1170270
R795	560kΩ	0101564	S8	LOUDNESS	1170270
R796	560kΩ	0101564	S9	LOW FILTER	1170270
R847	10Ω	0101100	S10	HIGH FILTER	1170270
R848	10Ω	0101100	S11	POWER/SPEAKERS	1101420
R850	10Ω	0101100	J501	MIC Jack	2430190
R853	0.47Ω	0155478	J502	DIN Socket	2430190
R854	0.47Ω	0155478	J503	Multi-Connector (F-2028)	2430040
R855	0.47Ω	0155478	J601	HEADPHONES	2420040
R856	0.47Ω	0155478	J801	Power Transformer	2430220
R857	4.7Ω	0104479	T001	Power Transformer	4001150
R858	4.7Ω	0104479	CO001	AC Outlet (UNSWITCHED)	2450040
R859	560Ω	0104561	CO002	AC Outlet (SWITCHED)	2450040
R860	560Ω	0104561	CO003	AC Outlet (SWITCHED)	2450040
R009	12kΩ	0104123	F001	Power Fuse (3A)	0433840
R010	5.6kΩ	0104562	F002	Power Fuse Holder	2300060
R011	5.6kΩ	0104562	F003	Quick-Acting Fuse (+ Power Supply, Lch.)	0433272
			F004	Quick-Acting Fuse (+ Power Supply, Rch.)	0433272
			F005	Quick-Acting Fuse (- Power Supply, Lch.)	0433272
			F01	Quick-Acting Fuse (- Power Supply, Rch.)	0432830
			F02	1A	0432830
			F03	1A	0432830
			F03	3A	0432870
				Wired-in Fuse	
VR701	250kΩ (M, N)	1010850	PL001	Power Indicator (6.3V 250mA)	0400090
VR702	BALANCE		PU001	Voltage Selector	2320080
VR703	250kΩ (B) × 2	1010850		Main Plug	2410180
VR704	VOLUME			Sub Plug	2410190
VR705	100kΩ (B) × 2	1010860		Socket	2410170
VR706	BASS			Printed Circuit Board for Protector Fuse F-1456	2598120
VR707	100kΩ (B) × 2	1010860			
VR708	MIDRANGE				
VR709	100kΩ (W) × 2	1010840			
VR710	TREBLE				
C003	0.01μF	0659801			
C004	±10% 1.4kV CC.	0515682			
C005	6800μF	0515682			
	50V CC.				
	6800μF				

* Design and specifications subject to change without notice for improvements.

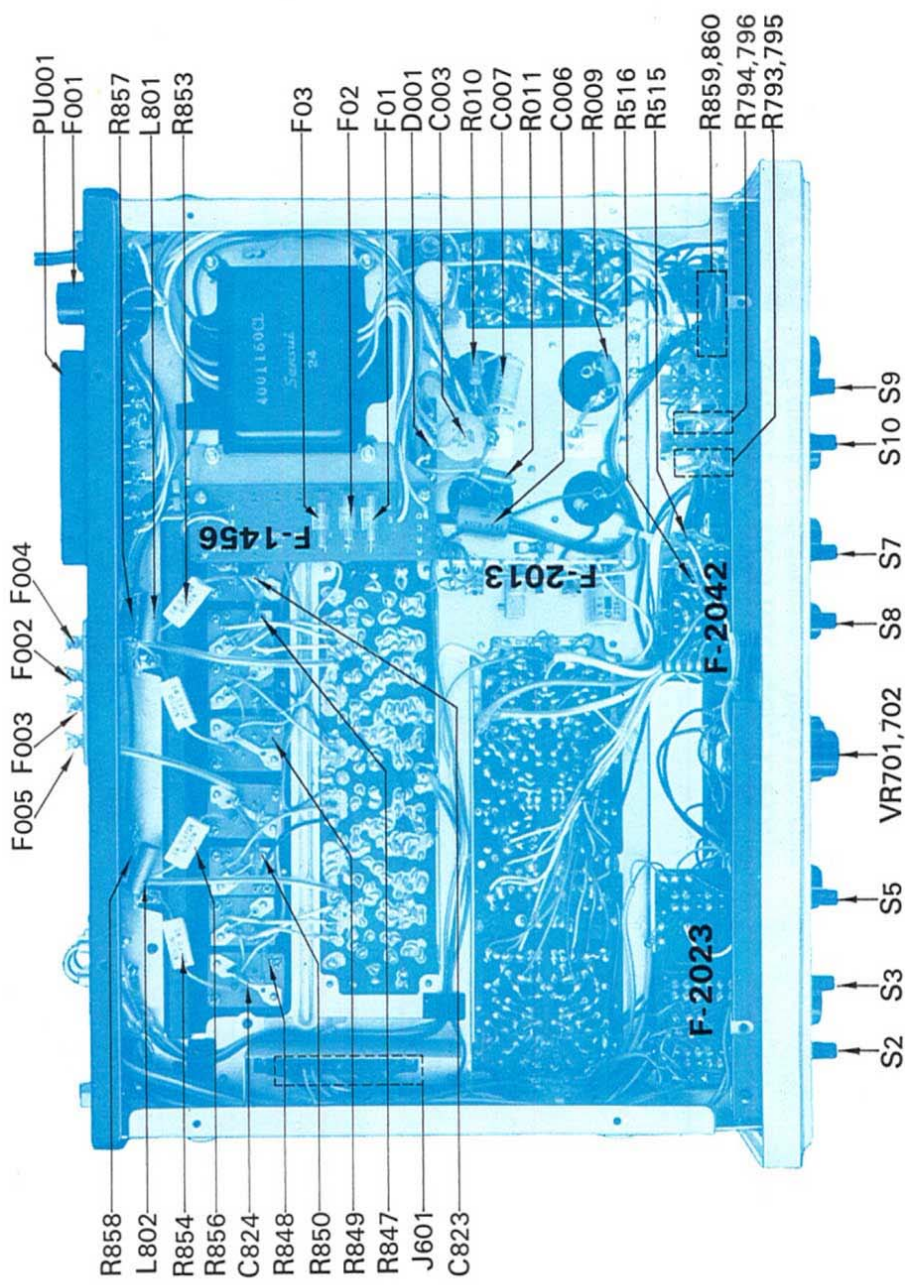
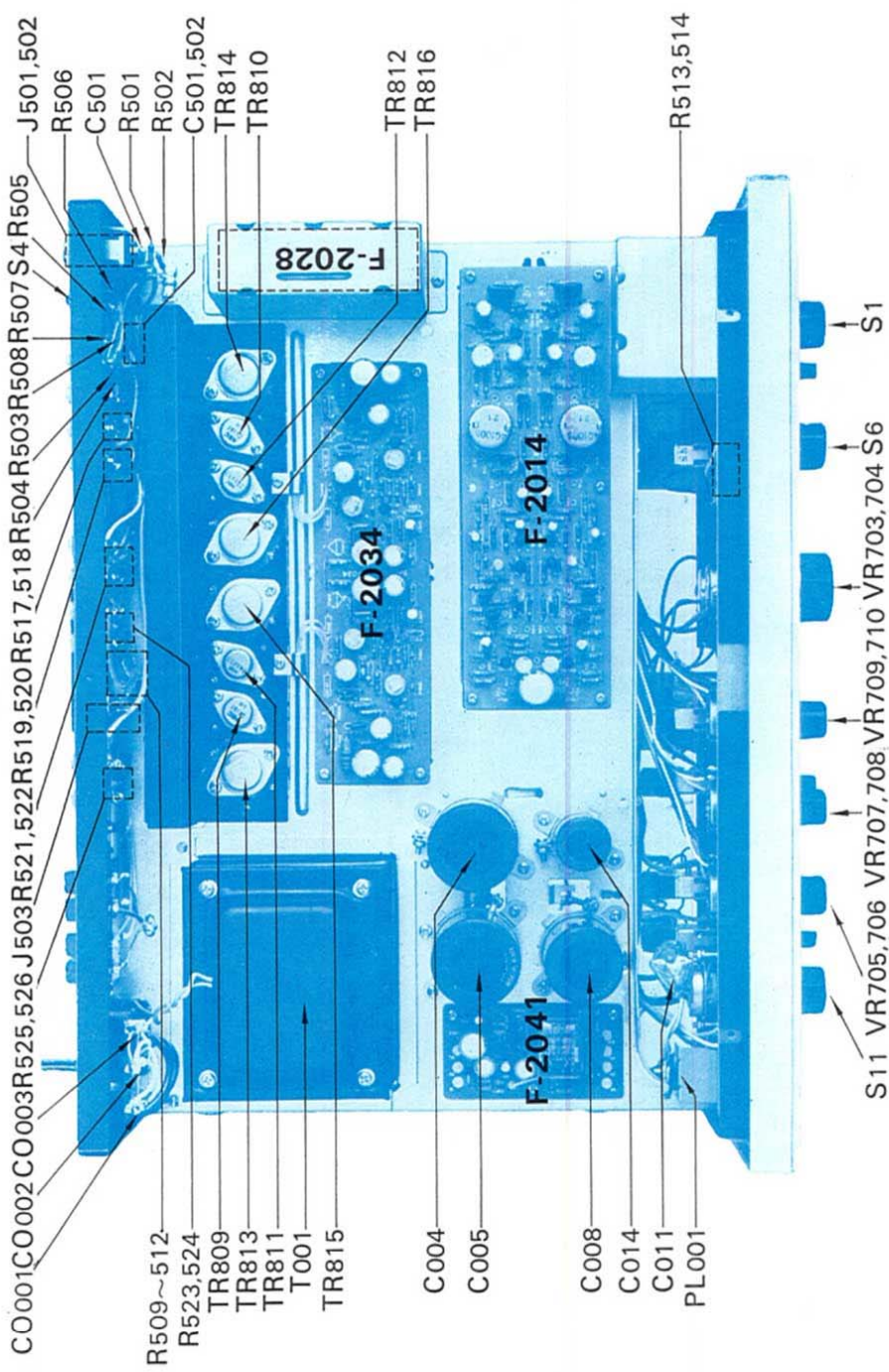



SANSUI ELECTRIC CO., LTD.
14-1, 2-chome, Izumi, Suginami-ku, Tokyo 168, Japan.
TELEPHONE: (03) 323-1111 /TELEX: 232-2076

Stock No. 9206960

Printed in Japan (82010M)