

SERVICE MANUAL

INTEGRATED AMPLIFIER

SANSUI AU-G30X



•SPECIFICATIONS

Power output

Min. RMS, both channels driven, from 20 to 20,000 Hz, with no more than 0.05% total harmonic distortion.
45 watts per channel into 8 ohms.

Load impedance..... 4 to 16 ohms

Total harmonic distortion

..... less than 0.05% at or below rated min. RMS power output

Intermodulation distortion

(60 Hz: 7 kHz=4:1 SMPTE method)
..... less than 0.05% at rated power output

Frequency response (at 1 watt)

Overall (from AUX, CD, TUNER, TAPE PLAY-1, 2)
..... 10 to 150,000 Hz, +0 dB
-3.0 dB

RIAA curve deviation (PHONO, 20 Hz to 20 kHz)

..... +0.2 dB, -0.2 dB

Input sensitivity and impedance (at 1 kHz)

PHONO 2.5 mV/47 kohms
(Max. input capability; 180 mV at 1 kHz, less than 0.01% total harmonic distortion)
CD, AUX 150 mV/47 kohms
TUNER, TAPE PLAY-1, 2
..... 150 mV/47 kohms

Signal to noise ratio (short-circuit, A-network)

PHONO 82 dB
CD, AUX 100 dB
TUNER, TAPE PLAY-1, 2 100 dB

Controls and Filter

BASS ±5 dB at 50 Hz
TREBLE ±5 dB at 10 kHz
LOUDNESS +6 dB at 50 Hz
+4 dB at 20 kHz
(VOLUME: -30 dB position)

FILTERS

LOW -3 dB at 16 Hz (6 dB/oct)
HIGH -3 dB at 10 kHz (6 dB/oct)

Power requirements

Power voltage 120/220/240V (50/60 Hz)
Power consumption ... 260 watts Rated
400 watts Maximum

Dimensions

430 mm (16-15/16") W
111 mm (4-3/8") H
329 mm (13") D

Weight

8.1 kg (17.9 lbs) net
9.2 kg (20.3 lbs) packed

* Design and specifications subject to changes without notice for improvements.

* Due to local laws and regulations, this unit sold in some areas are not equipped with variable voltage selectors.

CAUTION

1. Parts identified by the \triangle symbol on the schematic diagram and the parts list are critical for safety. Use only replacement parts that have critical characteristics recommended by the manufacturer.
2. Make leakage-current or resistance measurements to determine that exposed parts are acceptably insulated from the supply circuit before returning the appliance to the customer.

Sansui

SANSUI ELECTRIC CO., LTD.

CAUTION

- The symbols, UL, CSA, SA, BS, UK, EU, AS and XX (EXPORT) on the parts list and the schematic diagram mean followings respectively.
 UL..... Manufactured for U.S.A market.
 (Underwriters Laboratories approved model.)
 CSA Manufactured for Canadian market.
 SA..... Manufactured for South African market.
 BS, UK Manufactured for United Kingdom market.
 EU Manufactured for European market.
 AS..... Manufactured for Australian market.
 XX (EXPORT) Standard Version.
 NON MARK Common Parts.
- Some printed circuit boards are not supplied as the assembled. To separate these in this service manual, the stock No's are not indicated at the ends of the board names. However, the individual parts on the circuit boards are provided by orders.
- Since some of capacitors and resistors are omitted from parts lists in this service manual, refer to the Common Parts List for capacitors & resistors, which was issued on February 1983.
- Abbreviations in this service manual are as follows.

•Abbreviations List

C.R. : Carbon Resistor	E.B.L. : Low Leak Bi-Polar
S.R. : Solid Resistor	Electrolytic Capacitor
Ce.R. : Cement Resistor	Ta.C. : Tantalum Capacitor
M.R. : Metal Film Resistor	F.C. : Film Capacitor
F.R. : Fusing Resistor	M.P. : Metalized Paper Capacitor
N.I.R. : Non-Inflammable Resistor	P.C. : Polystyrene Capacitor
A.R. : Array Resistor	G.C. : Gimmic Capacitor
C.C. : Ceramic Capacitor	A.C. : Array Capacitor
C.T. : Ceramic Capacitor,	V.R. : Variable Resistor
Temoerature Compensation	S.V.R. : Semi Variable Resistor
E.C. : Electrolytic Capacitor	SW. : Switch
E.L. : Low Leak Electrolytic	Chip R. : Chip Resistor
Capacitor	Chip C. : Chip Capacitor
E.B. : Bi-Polar Electrolytic	
Capacitor	

1. BLOCK DIAGRAM

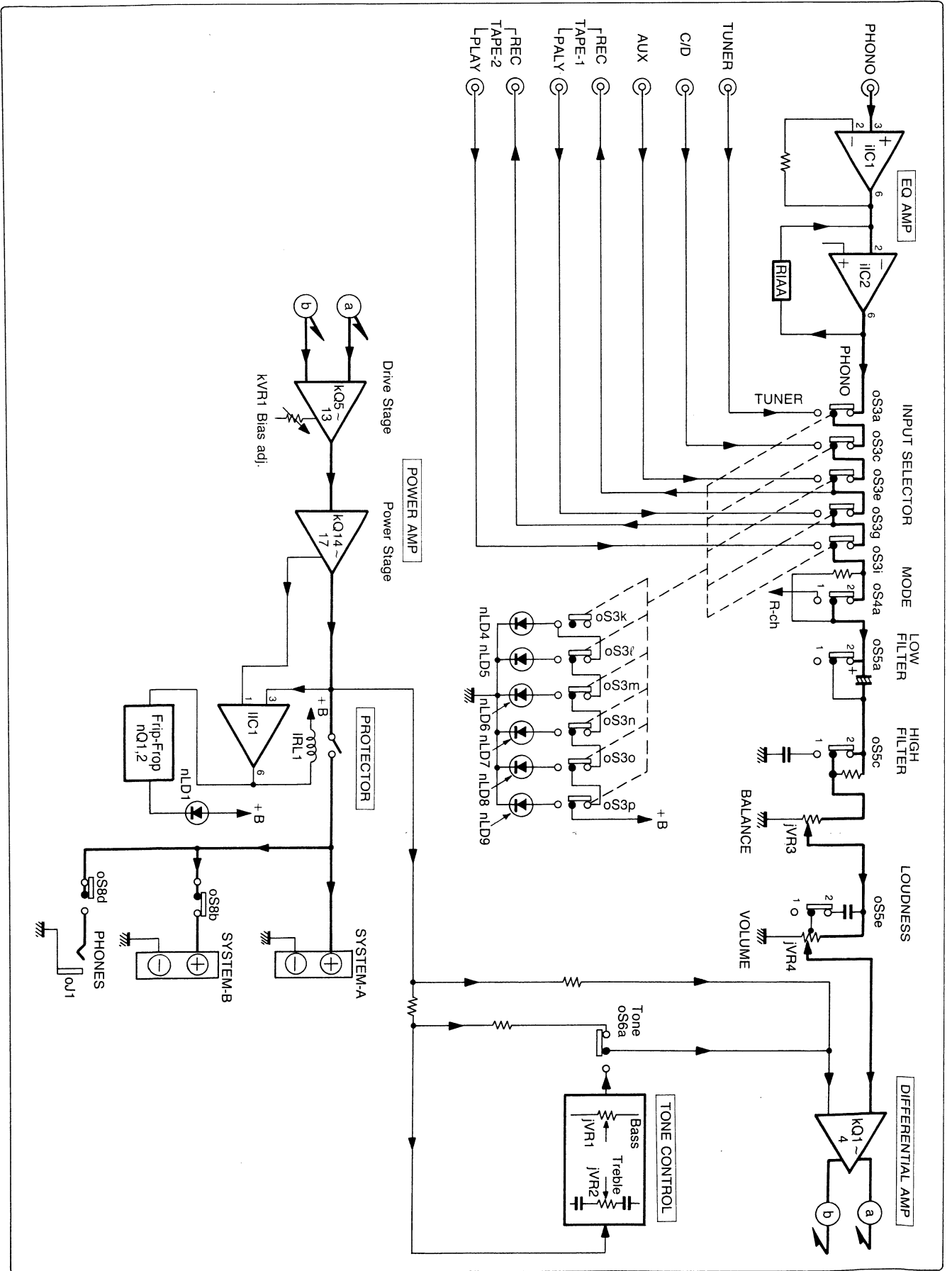

2. PARTS LOCATION AND PARTS LIST

2-1. F-3726 Tone Control Circuit Board

Component Side

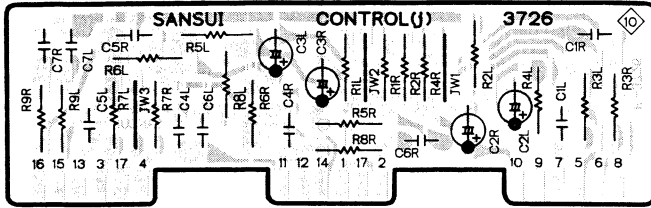

Parts List

Parts No.	Stock No.	Description
jC1	46696600	0.039 μ F 50V F.C.
jC2	46937000	0.22 μ F 50V E.B.
jC4	46692800	1000pF 50V F.C.
jC5	46695200	0.01 μ F 50V F.C.
jC6	46694800	6800pF 50V F.C.
jC7	46697200	0.068 μ F 50V F.C.

2-2. F-4704 POWER SW. Board

Component Side

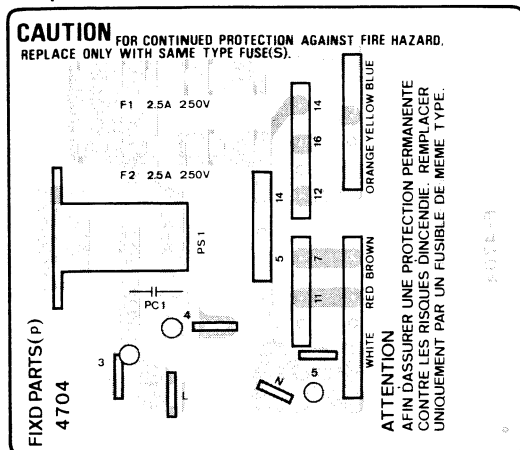

Parts List

Parts No.	Stock No.	Description
Δ pC1	46425800	0.01 μ F 400V C.C.
Δ pF1	48266900	AC Fuse 2.5A 250V (XX)
Δ pF2	07184800	Fuse 1.25A 250V (EU,BS)
Δ pF2	48266900	AC Fuse 2.5A 250V (XX)
Δ pS1	48113300	Push SW., POWER

2-3. F-5374 Control & Phones Jack Board (Stock No. 00973601)

Component Side

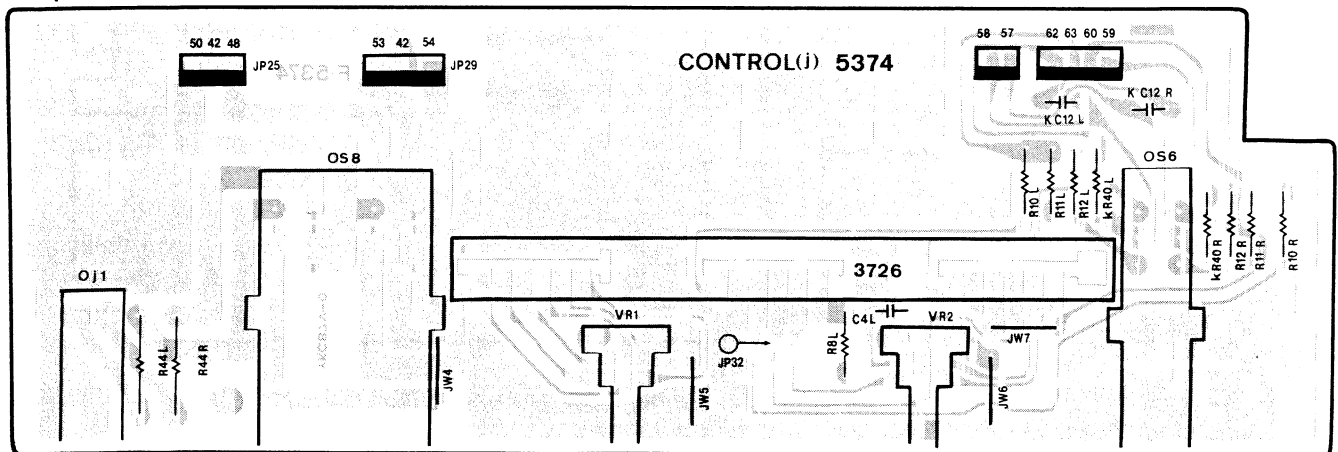

Parts List

Parts No.	Stock No.	Description
jC4	46692800	1000pF 50V F.C.
jVR1	48077500	50k Ω (C) V.R., BASS
jVR2	48077500	50k Ω (C) V.R., TREBLE
Δ kR44	46249700	220 Ω 1W N.I.R.

Parts No.	Stock No.	Description
oS6	48489500	Push SW., TONE SELECTOR
oS8	48077200	Push SW., SPEAKER SELECTOR
oJ1	46579600	Jack, PHONES

2-7. F-5378 Protector & Power Supply Board (Stock No. 00974001)

Component Side

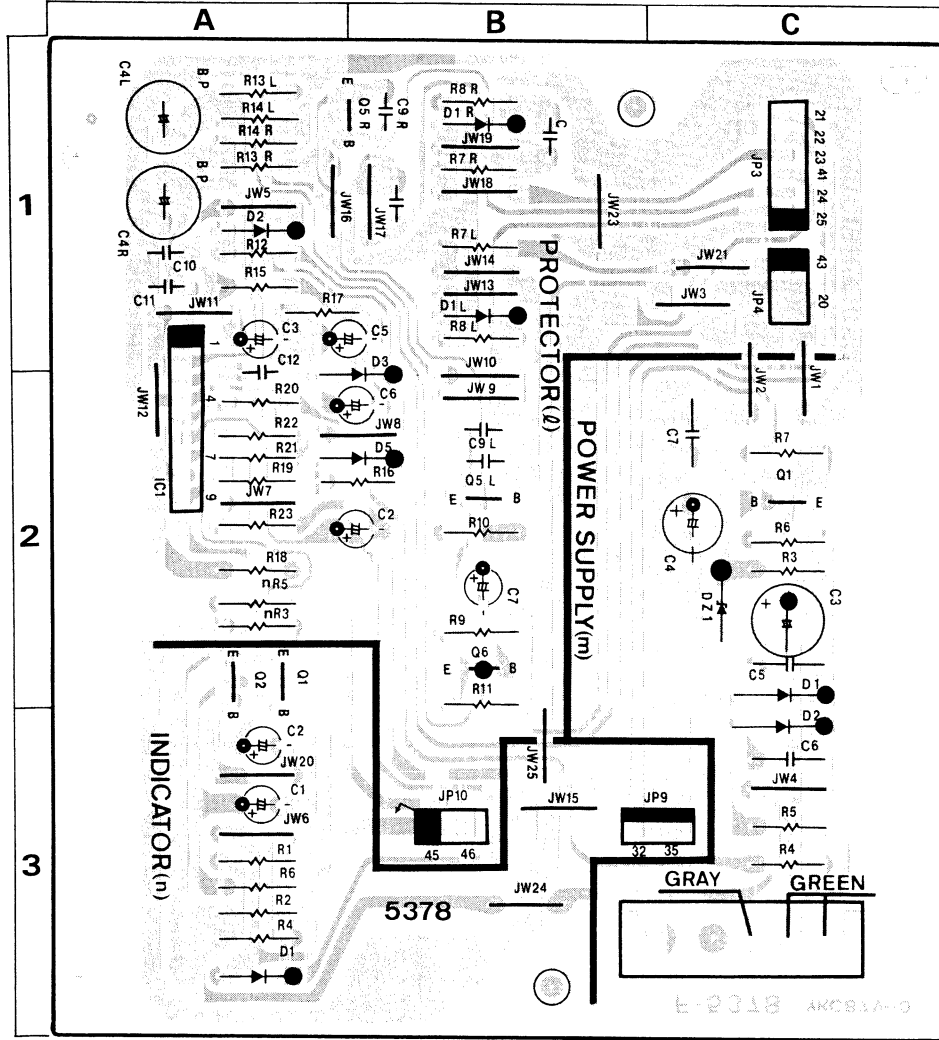

Parts List

Parts No.	Stock No.	Description	Position	Parts No.	Stock No.	Description	Position
• Transistor				• Diode			
IQ5	46581701	2SC1845	1B,2B	mD1	03117700	10E-2	2C
IQ6	46581601	2SA992	2B	mD2	03117700	10E-2	3C
• IC				• Zener Diode			
IC1	46207600	TA7317P	2A	mDZ1	46115100	05Z18-Y	2C
• Diode					or 46115200	05Z18-Z	2C
ID1	03117600	1S2473T77	1B	Δ mR4	46227200	3.3Ω 1/2W N.I.R.	3C
	or 46086000	1S1588TP-3	1B	Δ mR5	46227200	3.3Ω 1/2W N.I.R.	3C
ID2	03117600	1S2473T77	1A	Δ mR6	46229100	120Ω 1/2W N.I.R.	2C
	or 46086000	1S1588TP-3	1A	Δ mR7	46229800	470Ω 1/2W N.I.R.	2C
ID3	03117600	1S2473T77	2B	mC3	46300600	220μF 35V E.C.	2C
	or 46086000	1S1588TP-3	2B	mC4	46302400	1μF 50V E.C.	2C
ID5	03117600	1S2473T77	2B	mC5	08680400	0.01μF 500V C.C.	2C
	or 46086000	1S1588TP-3	2B	mC6	08680400	0.01μF 500V C.C.	3C
IC2	46310700	0.47μF 100V E.C.	2B	• Transistor			
IC3	46295200	47μF 16V E.C.	1A	nQ1	46367101	2SC2603	2A
IC4	48145900	220μF 6.3V E.B.	1A		or 46367301	2SC2458	2A
IC5	46302400	1μF 50V E.C.	1B		or 46391901	2SC2785	2A
IC6	46300000	47μF 35V E.C.	2B	nQ2	46367101	2SC2603	2A
IC7	46302800	10μF 50V E.C.	2B		or 46367301	2SC2458	2A
IC9	46283300	0.022μF 50V F.C.	1B,2B		or 46391901	2SC2785	2A
IC10	46282600	4700pF 50V F.C.	1A	• Diode			
IC11	46282600	4700pF 50V F.C.	1A	nD1	03117600	1S2473T77	3A
IC12	46282600	4700pF 50V F.C.	1A		or 46086000	1S1588TP-3	3A
• Transistor				nC1	46302700	4.7μF 50V E.C.	3A
Δ mQ1	03083901	2SD313HP	2C	nC2	46302700	4.7μF 50V E.C.	3A
Δ	or 46546701	2SD880	2C				

2-9. F-5383 Power Amp. Board (Stock No. 00974801)

Component Side

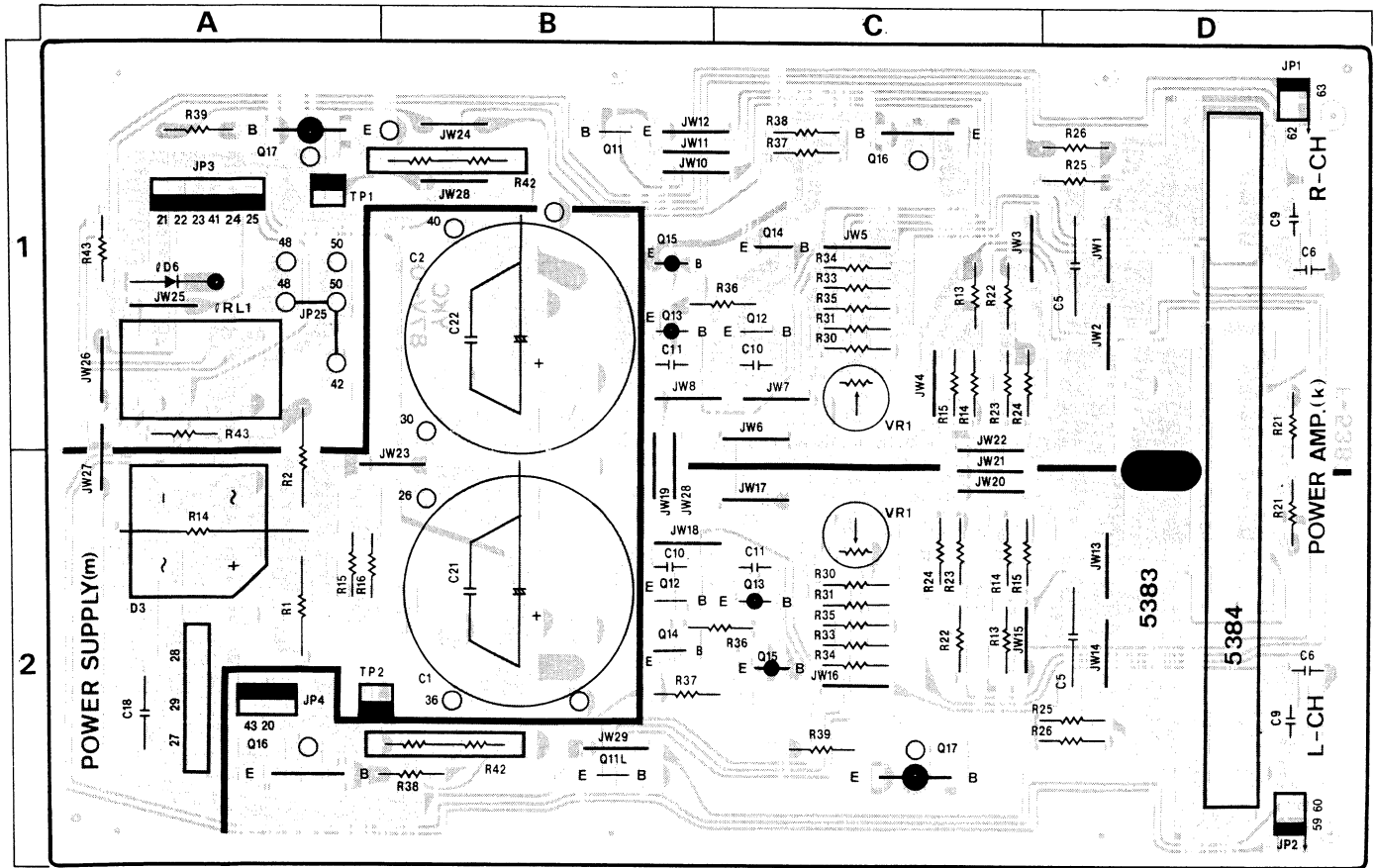

Parts List

Parts No.	Stock No.	Description	Position
•Transistor			
kQ11	03067401	2SC1845	1B,2B
kQ12	48113001	2SC2229	2B
kQ13	48112901	2SA949	1B
kQ14	46728901	2SC3298	2B
kQ15	46728801	2SA1306	1B
△kQ16	48489401	2SC3284	1C,2A
△kQ17	48489301	2SA1303	1A,2C
△kR13	46231000	4.7Ω 1/2W N.I.R.	1C,2C
△kR14	46231000	4.7Ω 1/2W N.I.R.	1C,2C
△kR15	46231000	4.7Ω 1/2W N.I.R.	1C,2C
△kR22	46231000	4.7Ω 1/2W N.I.R.	1C,2C
△kR23	46231000	4.7Ω 1/2W N.I.R.	1C,2C
△kR24	46231000	4.7Ω 1/2W N.I.R.	1C,2C
△kR36	46230200	1kΩ 1/2W N.I.R.	1C,2C
△kR37	46229300	180Ω 1/2W N.I.R.	1C,2B
△kR38	46227400	4.7Ω 1/2W N.I.R.	1C,2B
△kR39	46227400	4.7Ω 1/2W N.I.R.	1A,2C
△kR42	46644800	0.22ΩX2 5W Ce.R.	1B,2B

Parts No.	Stock No.	Description	Position
kC5	46222800	0.22μF 100V F.C.	1D,2D
kC16	46700900	0.01μF 50V F.C.	1C,2C
kVR1	10341900	470Ω (B) S.V.R., bias adj.	1C,2C
•Diode			
ID6	03117700	10E-2	1A
IRL1	48429900	Relay	1A
•Diode			
mD3	46864000	RB602	2A
△mR1	46251600	8.2kΩ 1W N.I.R.	2A
△mR2	46251600	8.2kΩ 1W N.I.R.	2A
mC1	48076300	8200μF 56V E.C.	2B
mC2	48076300	8200μF 56V E.C.	1B
mC18	46078400	0.47μF 200V F.C.	2A
mC21	46222800	0.22μF 100V F.C.	2B
mC22	46222800	0.22μF 100V F.C.	1B

2-10. F-5377 Indicator Board

Component Side

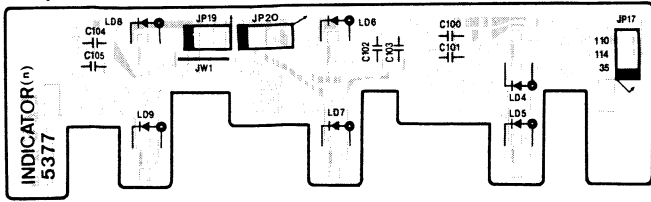

Parts List

Parts No.	Stock No.	Description
•LED		
nLD4	48076100	SEL2413E, PHONO
nLD5	48076100	SEL2413E, TUNER
nLD6	48076100	SEL2413E, CD
nLD7	48076100	SEL2413E, AUX
nLD8	48272600	SEL2213C, TAPE-1
nLD9	48272600	SEL2213C, TAPE-2/PCM

2-11. F-5380 Protector Indicator Board

Component Side

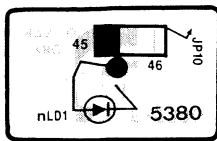

Parts List

Parts No.	Stock No.	Description
•LED		
nLD1	46169300	SEL1210S, PROTECTOR

2-12. F-5382 TAPE Terminal Board

Component Side

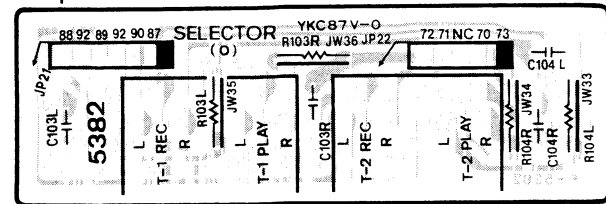

Parts List

Parts No.	Stock No.	Description
oZ3	46363800	4P Terminal, TAPE-1
oZ4	46363800	4P Terminal, TAPE-2

2-13. F-5387 REC SELECTOR Board

Component Side

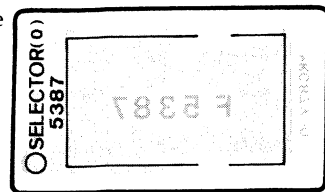

Parts List

Parts No.	Stock No.	Description
oZ7	48483900	Rotary SW., REC SELECTOR

2-14. F-5384 Driver Amp. Board (Stock No. 00974901)

Component Side

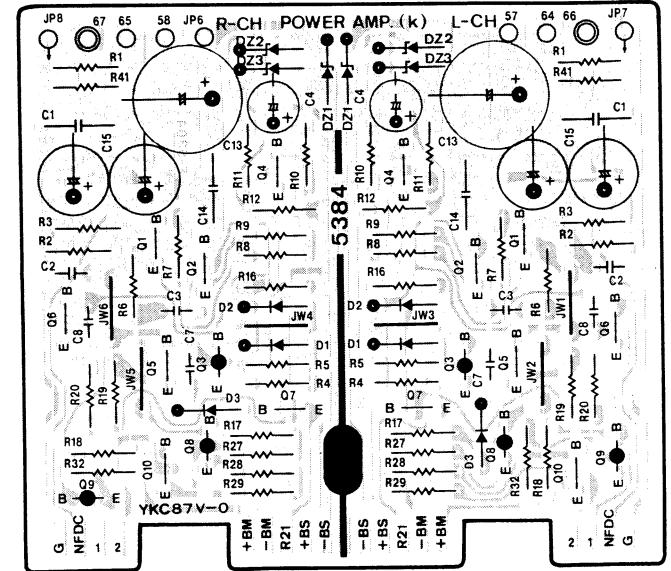

Parts List

Parts No.	Stock No.	Description
•Transistor		
kQ1	46581701	2SC1845
kQ2	46581701	2SC1845
kQ3	46581601	2SA992
kQ4	46581701	2SC1845
kQ5	46581701	2SC1845
kQ6	46581701	2SC1845
kQ7	46581701	2SC1845
kQ8	46581601	2SA992
kQ9	48112901	2SA949
kQ10	48113001	2SC2229
•Diode		
kD1	03117600	1S2473T77
	or 46086000	1S1588TP-3
kD2	03117600	1S2473T77
	or 46086000	1S1588TP-3
kD3	03117600	1S2473T77
	or 46086000	1S1588TP-3
•Zener Diode		
kDZ1	46113800	05Z12-X
	or 46113900	05Z12-Y
kDZ2	46113800	05Z12-X
	or 46113900	05Z12-Y
kDZ3	46111700	05Z6.2-X
	or 46111800	05Z6.2-Y
kR2	46452500	1.8kΩ 1/2W C.R.
ΔkR27	46230100	820Ω 1/2W N.I.R.
ΔkR28	46230100	820Ω 1/2W N.I.R.
ΔkR29	46229100	120Ω 1/2W N.I.R.
ΔkR32	46229100	120Ω 1/2W N.I.R.
kC1	46222800	0.22μF 100V F.C.
kC14	46222800	0.22μF 100V F.C.
kC15	46627900	47μF 50V E.C.

3. ADJUSTMENT

- Note:** 1) Master Volume Minimum
 2) Room Temperature 18°C~28°C (65°F~83°F)
 3) For this adjustment, run the unit for more than 15 minutes after the power is switched ON.
 4) Before turning ON power switch, set kVR1 on F-5383 to center position.

STEP	SUBJECT	MEASURE OUTPUT	ADJUST	ADJUST FOR	REMARKS
1.	Bias Current Adj. L-CH	Between emitters of power transistors (kQ16L & kQ17L) <Across kR42L >	kVR1, L-ch (F-5383)	DC 20mV ± 2mV	•This bias value is converted from current value to voltage by ohms law.
2.	Bias Current Adj. R-CH	Between emitters of power transistors (kQ16R & kQ17R) <Across kR42R >	kVR1, R-ch (F-5383)	DC 20mV ± 2mV	

4. OTHER PARTS

4-1. Front View

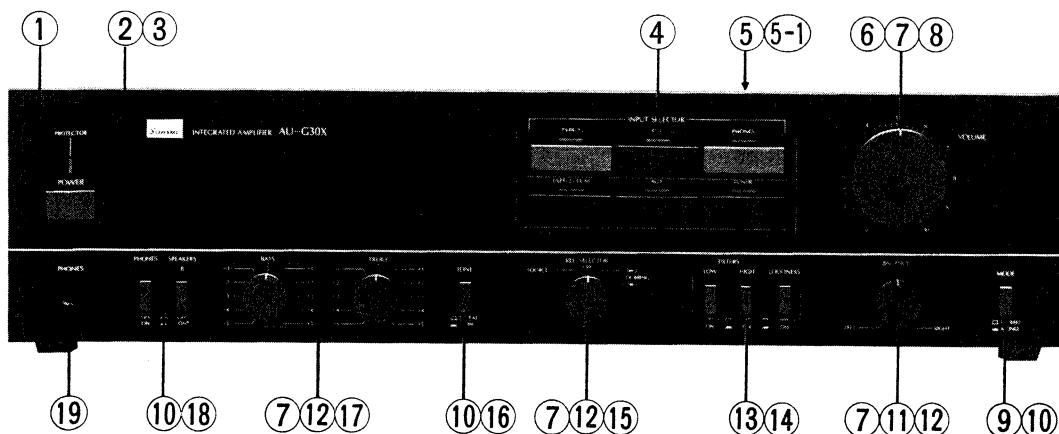

Parts List

Parts No.	Stock No.	Description
1	27160100	Front Panel Ass'y
2	47633700	Knob, POWER
△3	48113300	Push SW., POWER
4	48271300	Push SW., INPUT SELECTOR
5	47703600	Bonnet (xx)
	47648300	Bonnet Ass'y (EU,BS)
5-1	47560800	Grille of Bonnet (EU,BS)
6	48429800	150kΩx2 VR., VOLUME
7	47287800	FS Holder
8	47636400	Knob, VOLUME
9	48077000	Push SW., MODE
10	47636300	Push Knob, MODE, PHONES, TONE, SPEAKERS
11	48077400	250kΩ (MN) VR., BALANCE
12	47636600	Knob, BALANCE, REC SELECTOR
		TREBLE, BASS
13	48076900	Push SW., LOW, HIGH, LOUDNESS
14	47636300	Knob, LOW, HIGH, LOUDNESS
15	48271510	Flexible Wire (Rotary)
16	48489500	Push SW., TONE
17	48077500	50kΩ (C) VR., TREBLE, BASS
18	48077200	Push SW., SPEAKERS
19	46579600	Jack, PHONES

to be continued on page 11 ▶

5. SCHEMATIC DIAGRAM

• Design and specifications subject to change without notice for improvement.
 • La présentation et les spécifications sont susceptibles d'être modifiées sans préavis par suites d'améliorations éventuelles.
 • Änderungen, die dem technischen Fortschritt dienen, bleiben vorbehalten.

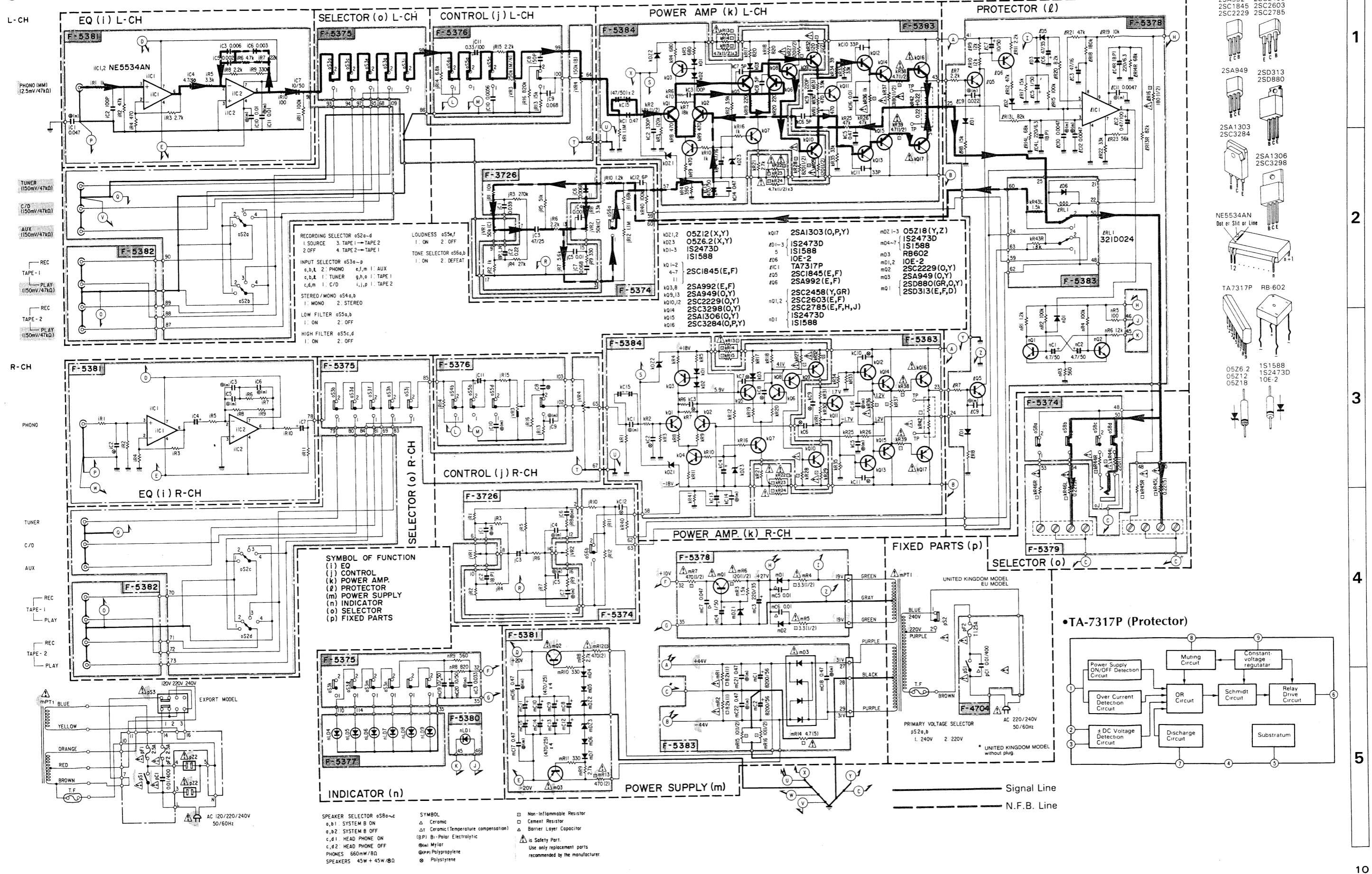

1
2
3
4
5
10

4-2. Top View

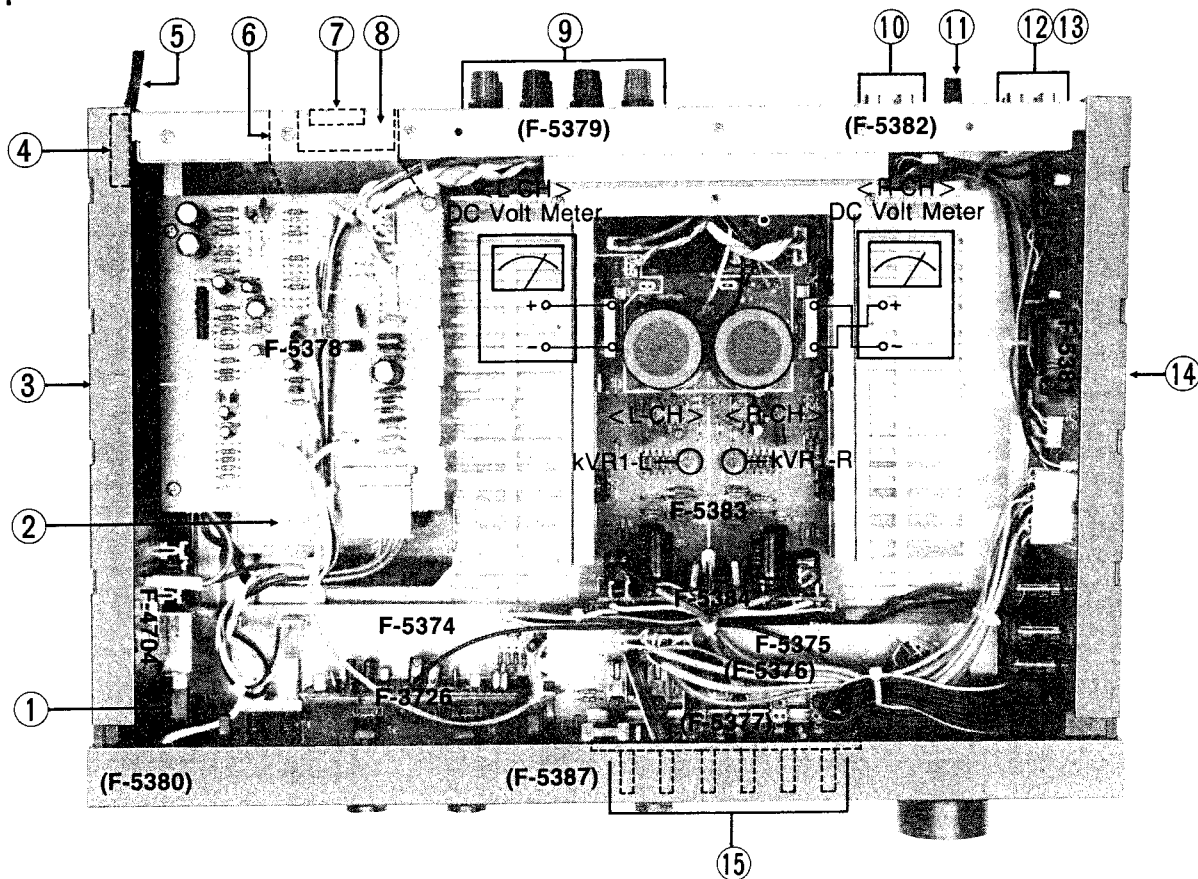

Parts List

Parts No.	Stock No.	Description
1	47637300	Joint Shaft, POWER SW
△2	15018001	Power Transformer (xx)
△	15018005	Power Transformer (EU·BS)
3	47608900	Side Panel Ass'y (L)
4	47157300	AC Cord Cover
△5	38004700	Power Supply Cord (xx)
△	38004300	Power Supply Cord (BS)
△	38004500	Power Supply Cord (EU)
6	47675400	Insulation Sheet (EU·BS)
△7	48062100	Slide SW., Voltage Selector (xx)
△	07204700	Slide SW., Voltage Selector (EU·BS)
△8	48076600	AC Outlet (xx)
9	48123100	8P Terminal Board, SPEAKERS
10	46363800	4P Terminal Board, TAPE-1, TAPE-2/PCM
11	22301510	Ground Terminal
12	46438100	2P Terminal Board, PHONO
13	46546800	6P Terminal Board, TUNER, CD, AUX
14	47638600	Side Panel Ass'y (R)
15	47637400	Joint Shaft, INPUT SELECTOR SW.

4-2. Top View

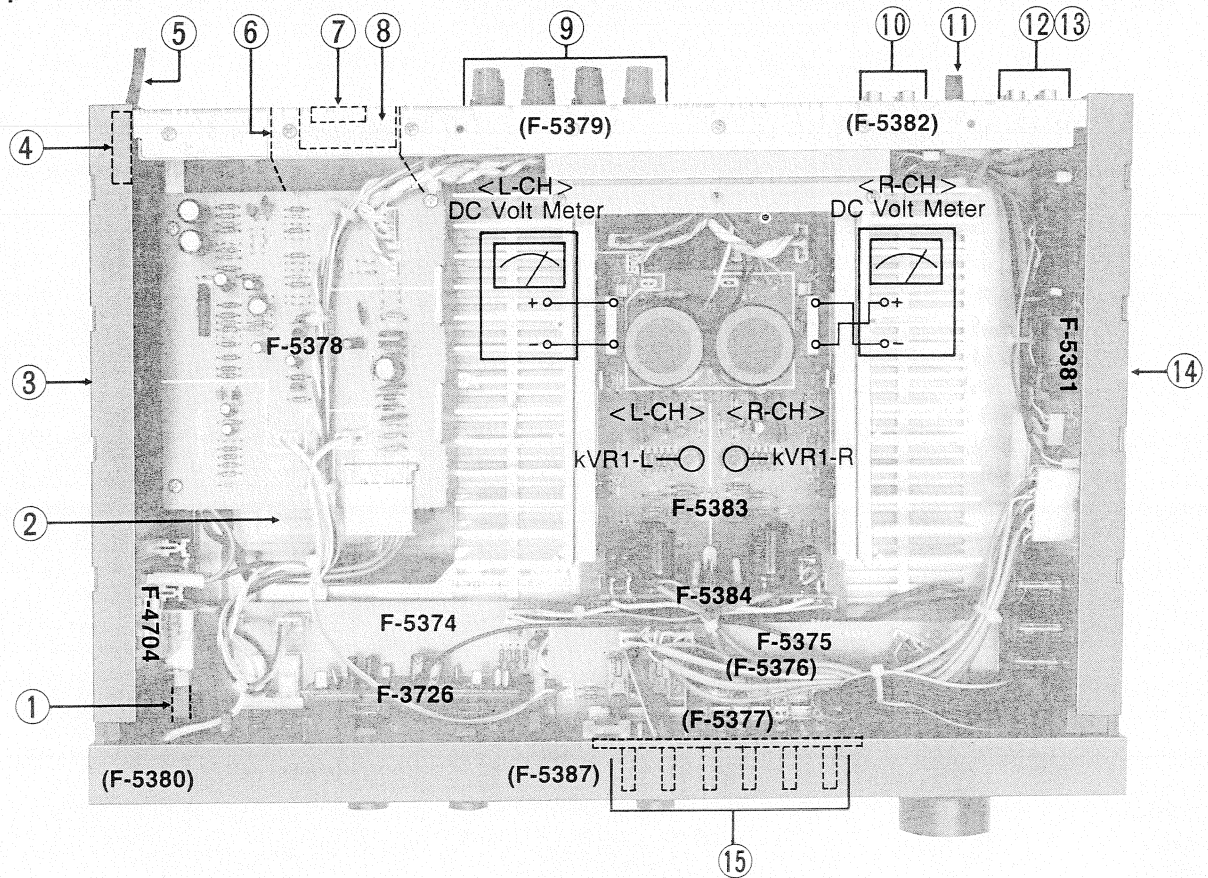

Parts List

Parts No.	Stock No.	Description
1	47637300	Joint Shaft, POWER SW
△2	15018001	Power Transformer (xx)
△	15018005	Power Transformer (EU·BS)
3	47608900	Side Panel Ass'y (L)
4	47157300	AC Cord Cover
△5	38004700	Power Supply Cord (xx)
△	38004300	Power Supply Cord (BS)
△	38004500	Power Supply Cord (EU)
6	47675400	Insulation Sheet (EU·BS)
△7	48062100	Slide SW., Voltage Selector (xx)
△	07204700	Slide SW., Voltage Selector (EU·BS)
△8	48076600	AC Outlet (xx)
9	48123100	8P Terminal Board, SPEAKERS
10	46363800	4P Terminal Board, TAPE-1, TAPE-2/PCM
11	22301510	Ground Terminal
12	46438100	2P Terminal Board, PHONO
13	46546800	6P Terminal Board, TUNER, CD, AUX
14	47638600	Side Panel Ass'y (R)
15	47637400	Joint Shaft, INPUT SELECTOR SW.

6. PACKING LIST

Parts No.	Stock No.	Description
1	47858600	Vinyl Cover
2	47675300	Styrofoam Packing
3	27159800	Carton Case
4	27061300	Sub Styrofoam Packing

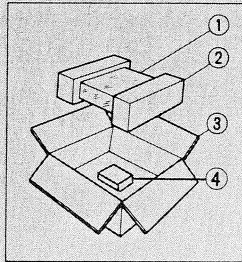

7. ACCESSORY LIST

Stock No.	Description
46998100	Operating Instruction (*E•F•S)
46998200	Operating Instruction (*G•I•Sw)

*** Note:**

E•F•S: English•French and Spanish Version

G•I•Sw: German•Italian and Swedish Version



SANSUI ELECTRIC CO., LTD.

SANSUI ELECTRONICS CORPORATION

SANSUI ELECTRONICS (U.K.) LTD

SANSUI ELECTRONICS G.M.B.H.

14-1, Izumi 2-chome, Suginami-ku, Tokyo 168 Japan
 PHONE: (03) 324-8891/TELEX: 232-2076 (International Division)

1250 Valley Brook Ave. Lyndhurst, N.J. 07071 U.S.A.
 17150 South Margay Ave. Carson, California 90746 U.S.A.

3036 Koapaka Street, Honolulu, Hawaii 96819 U.S.A.

Unit 10A, Lyon Industrial Estate, Rockware Avenue, Greenford, Middx UB6, OAA, England
 Pau Ehrich Strasse 8, 6074 Rödermark 2, West Germany

(SM1-307)

Printed in Japan (366010M) <Stock No. 36522900>