

SANSUI SERVICE MANUAL

AU-~~Q~~907MR / MRX

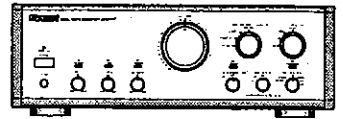

AU-~~Q~~707MR / MRX

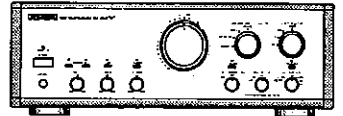

AU-~~Q~~607MR / MRX

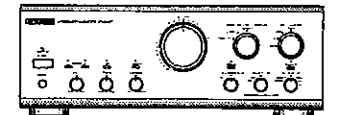

HIGH GRADE STEREOPHONIC INTEGRATED AMPLIFIER

CAUTION (注意)

1. Parts identified the Δ symbol on the schematic diagram and the parts list are critical for safety. Use only replacement parts that have critical characteristics recommended by the manufacturer.
2. Make leakage-current for resistance measurements to determine that exposed parts are acceptably insulated from the supply circuit before returning the appliance to the customer.

Δ 印がついている部品は、安全性を維持するために、重要な部品です。
これらの部品を交換する際には、必ず指定された部品を使用して下さい。

Notice / 告知

Table of Contents / 目次

The symbols OO and XX on the parts list and the schematic diagram mean followings respectively.

日本国向け製品専用部品には"OO"マークが付いて居ます。

OO Manufactured for Japanese market.

XX Standard Version.

(EXPORT) (Non Japanese market.)

XX-C Standard Version.

(For People's Republic of China market.)

XX-T Standard Version.

(For Republic of China market.)

Non Mark Common parts.

マークの無い部品は全仕向け共通です。

1	Caution / 注意書
1	Notice / 告知
1	Table of Contents / 目次
2	Specifications / 仕様"#1"
5	Schematic Diagram / 回路図"#2"
11	Adjustment / 調整方法 "#3"
15	Interior Block Diagram & terminal Function of ICs / IC の内部図"#4"
16	Parts Location on Printed Circuit Board / 基板の部品配置図"#5"
24	Parts List of Printed Circuit Board / プリント基板の部品表 "#6"
45	Mechanism Parts List / 機構部品表"#7"
48	Packing list / 梱包材部品表"#8"
	Accessories / 付属部品表"#9"

Model name markers "[???" in top of any page indicate be written of this model here.

各頁上部に記載されて居ます機種名の **記号**

盛り込まれて居ることを示して居ます。

1. SPECIFICATIONS / 仕様

1-1. AU - Ⓔ907MR and AU - Ⓔ907MRX

● Main Amplifier Section / 主増幅器部

Power band width / 帯域実効出力

(at 10Hz - 20kHz & lesser than 0.003% total harmonics distortion)

At each channel into 8Ω 160Wr.m.s.

At each channel into 6Ω 190Wr.m.s.

Total harmonics distortion (at 20Hz-20kHz) / 全高調波歪率

At 160W output each channel into 8Ω 0.003%

At 95W output each channel into 6Ω 0.005%

Inter modulations distortion (at 60Hz : 7kHz = 4 : 1 input) / 混変調歪率

At 160W output each channel into 8Ω 0.003%

Dumping factor (at 1kHz into 8Ω) / ダンプ・ファクター 150

Frequency response (at 1W output) / 周波数特性

D.C. ~ 300kHz ± 3 dB

Input sensitivity and impedance (at 1kHz) / 入力感度 ... 1Vr.m.s. / 5kΩ

Signal to noise ratio (at 1W into I.H.F. - A202 network) / SN比

Short circuit (Short their input terminals) 120dB

Dynamic power / ダイナミック・パワー

At each channel into 6Ω 310Wr.m.s.

At each channel into 4Ω 390Wr.m.s.

At each channel into 2Ω 580Wr.m.s.

Envelope distortion / エンベロープ歪 Below measurable limit

T. I. M. distortion / TIM歪 Below measurable limit

Through late (at each channel into 8Ω) / 遅延 200V / μSec.

Rise time / ライズ・タイム 0.5 μSec.

Channel separation (at 1kHz) / チャンネル・セパレーション 90dB

Noise (at each channel into 8Ω) / 残留雑音 0.5mVr.m.s.

Output power of head phone terminal / ヘッドホン出力 0.5Vr.m.s. / 33Ω

Load impedance (of speaker terminals at each channel) / 負荷

4Ω - 16Ω

● Pre Amplifier Section / 前置増幅器部

Input sensitivity and impedance (at 1kHz) / 入力感度

PHONO (MC) input terminals 0.3mVr.m.s. / 100Ω

PHONO (MM) input terminals 2.5mVr.m.s. / 47kΩ

The other input terminals 150mVr.m.s. / 20kΩ

Maximum input capability (at 1kHz) / 最大許容入力

PHONO (MC) input terminals (less than 0.1% THD) 21mV

PHONO (MM) input terminals (less than 0.01% THD) 210mV

Output voltage and impedance (at 1kHz) / 出力電圧

TAPE RECORDING terminals 150mVr.m.s. / 47kΩ

Frequency response (at 1W output) / 周波数特性

PHONO (MM) input terminals 20Hz ~ 20kHz ± 0.2 dB

The other input terminals D.C. ~ 300kHz ± 3 dB

Signal to noise ratio (into I.H.F. - A202 network , short circuit) / SN比

PHONO (MC) input terminals 75dB

PHONO (MM) input terminals 90dB

The other input terminals 110dB

Separation of channels (at 1kHz) / チャンネル・セパレーション

PHONO (MC) input terminals 50dB

PHONO (MM) input terminals 65dB

The others input terminals 85dB

Separation of the other sources (at 1kHz) / クロス・トーク

TUNER ↔ PHONO (MM) 85dB

CD, TAPE ↔ PHONO (MM) 90dB

CD, TUNER ↔ TAPE 90dB

TAPE ↔ TAPE 90dB

Tone control / トーン・コントロール

Bass (at 50Hz) & Treble (at 15kHz) +6dB ~ -6dB

Subsonic filter / サブソニック・フィルター cut off 16Hz, slope 6dB / oct.

Roudness filter (at -30dB point of master volume) / ラウドネス

+6dB at 50Hz, +4dB at 10kHz

● General Section (The others) / 総合部

External Maximum consumption power of extra outlet / A.C. 70A・レト

Switched maximum 100W

Unswitched total maximum 250W

Power requirements / 供給電源

AU - Ⓔ907MR A.C. 100V / 50Hz or 60Hz

AU - Ⓔ907MRX A.C. 110V / 50Hz or 60Hz

..... or A.C. 230V / 50Hz or 60Hz

Power consumption / 定格消費電力

AU - Ⓔ907MR 400W

AU - Ⓔ907MRX 800W

Dimensions (Package dimensions) / 外形寸法 (梱包時)

Width 471mm (579mm)

Height 163mm (267mm)

Depth 452mm (537mm)

Weight of solid (Packet weight) / 本体質量 (梱包時質量)

33.0kg (35.0kg)

Bulk (Volume of packet) / 梱包寸数 2-11cft / 0.083m³

●Design and specifications subject to change without notice for improvements.

●Due to local laws and regulations, this unit sold in some areas are not equipped with variable voltage selector.

●本機の意匠及び仕様の一部は、改良の為、予告無く変更する事が有ります。

1-2. AU - 707MR and AU - 707MRX

● Main Amplifier Section / 主増幅器部

Power band width / 帯域実効出力

(at 10Hz ~ 20kHz & lesser than 0.003% total harmonics distortion)

At each channel into 8Ω 130Wr.m.s.

At each channel into 6Ω 160Wr.m.s.

Total harmonics distortion (at 10Hz~20kHz) / 全高調波歪率

At 130W output each channel into 8Ω 0.003%

At 85W output each channel into 6Ω 0.005%

Inter modulations distortion (at 60Hz : 7kHz = 4 : 1 input) / 混変調歪率

At 130W output each channel into 8Ω 0.003%

Dumping factor (at 1kHz into 8Ω) / ダムピング・ファクター 150

Frequency response (at 1W output) / 周波数特性

D.C. ~ 300kHz ± 3 dB

Input sensitivity and impedance (at 1kHz) / 入力感度 ... 1Vr.m.s. / 5kΩ

Signal to noise ratio (at 1W into I.H.F. - A202 network) / SN比

Short circuit (Short their input terminals) 120dB

Dynamic power / ダイナミック・パワー

At each channel into 6Ω 210Wr.m.s.

At each channel into 4Ω 320Wr.m.s.

At each channel into 2Ω 405Wr.m.s.

Envelope distortion / エンベロープ歪 Below measurable limit

T. I. M. distortion / TIM歪 Below measurable limit

Through late (at each channel into 8Ω) / 遅延・レイト . 200V / μ Sec.

Rise time / ライズ・タイム 0.5 μ Sec.

Channel separation (at 1kHz) / チャンネル・セパレーション 90dB

Noise (at each channel into 8Ω) / 残留雑音 0.5mVr.m.s.

Output power of head phone terminal / ヘッドホン出力 0.5Vr.m.s. / 33Ω

Load impedance (of speaker terminals at each channel) / 負荷

Each system ("A" system or "B" system) 4Ω ~ 16Ω

Both systems ("A" system and "B" system) 8Ω ~ 16Ω

● Pre Amplifier Section / 前置増幅器部

Input sensitivity and impedance (at 1kHz) / 入力感度

PHONO (MC) input terminals 0.3mVr.m.s. / 100Ω

PHONO (MM) input terminals 2.5mVr.m.s. / 47kΩ

The other input terminals 150mVr.m.s. / 20kΩ

Maximum input capability (at 1kHz) / 最大許容入力

PHONO (MC) input terminals (less than 0.1% THD) 21mV

PHONO (MM) input terminals (less than 0.01% THD) 210mV

Output voltage and impedance (at 1kHz) / 出力電圧

TAPE RECORDING terminals 150mVr.m.s. / 47kΩ

Frequency response (at 1W output) / 周波数特性

PHONO (MM) input terminals 20Hz ~ 20kHz ± 0.2 dB

The other input terminals D.C. ~ 200kHz ± 3 dB

Signal to noise ratio (into I.H.F. - A202 network , short circuit) / SN比

PHONO (MC) input terminals 70dB

PHONO (MM) input terminals 88dB

The other input terminals 110dB

Separation of channels (at 1kHz) / チャンネル・セパレーション

PHONO (MC) input terminals 50dB

PHONO (MM) input terminals 65dB

The others input terminals 85dB

Separation of the other sources (at 1kHz) / クロス・トーク

TUNER \leftrightarrow PHONO (MM) 85dB

CD , TAPE \leftrightarrow PHONO (MM) 90dB

CD , TUNER \leftrightarrow TAPE 90dB

TAPE \leftrightarrow TAPE 90dB

Tone control / トーン・コントロール

Bass (at 50Hz) & Treble (at 15kHz) +6dB ~ -6dB

Subsonic filter / サブソニック cut off 16Hz , slope 6db / oct.

Roudness filter (at -30dB point of master volume) / ラウドネス

+6dB at 50Hz , +4dB at 10kHz

● General Section (The others) / 総合部

External Maximum consumption power of extra outlet / A.C. 7外・レイト

Switched maximum 100W

Unswitched total maximum 250W

Power requirements / 供給電源

AU - 707MR A.C. 100V / 50Hz or 60Hz

AU - 707MRX A.C. 110V / 50Hz or 60Hz

..... or A.C. 230V / 50Hz or 60Hz

Power consumption / 定格消費電力

AU - 707MR 330W

AU - 707MRX 630W

Dimensions (Package dimensions) / 外形寸法 (梱包時)

Width 466mm (579mm)

Height 162mm (267mm)

Depth 452mm (537mm)

Weight of solid (Packet weight) / 本体質量 (梱包時質量)

23.5kg (25.0kg)

Bulk (Volume of packet) / 梱包寸数 2-11cft / 0.083m³

●Design and specifications subject to change without notice for improvements.

●Due to local laws and regulations, this unit sold in some areas are not equipped with variable voltage selector.

●本機の意匠及び仕様の一部は、改良の為、予告無く変更する事が有ります。

1-3. AU – Ⓜ607MR and AU – Ⓜ607MRX

● Main Amplifier Section / 主増幅器部

Power band width / 帯域実効出力

(at 10Hz ~ 20kHz & lesser than 0.003% total harmonics distortion)

At each channel into 8Ω 90Wr.m.s.

At each channel into 6Ω 105Wr.m.s.

Total harmonics distortion (at 10Hz~20kHz) / 全高調波歪率

At 90W output each channel into 8Ω 0.003%

At 52.5W output each channel into 6Ω 0.005%

Inter modulations distortion (at 60Hz : 7kHz = 4 : 1 input) / 混交調歪率

At 90W output each channel into 8Ω 0.003%

Dumping factor (at 1kHz into 8Ω) / タンク・ファクタ 150

Frequency response (at 1W output) / 周波数特性

D.C. ~ 300kHz ± 3 dB

Input sensitivity and impedance (at 1kHz) / 入力感度 ... 1Vr.m.s. / 5kΩ

Signal to noise ratio (at 1W into I.H.F. - A202 network) / SN比

Short circuit (Short their input terminals) 120dB

Dynamic power / ダイナミック・パワー

At each channel into 6Ω 155Wr.m.s.

At each channel into 4Ω 220Wr.m.s.

At each channel into 2Ω 280Wr.m.s.

Envelope distortion / 包絡線歪 Below measurable limit

T. I. M. distortion / TIM歪 Below measurable limit

Through late (at each channel into 8Ω) / 遅延 180V / μ Sec.

Rise time / ライズ・タイム 0.6 μ Sec.

Channel separation (at 1kHz) / チャンネル・セパレーション 85dB

Noise (at each channel into 8Ω) / 残留雑音 0.5mVr.m.s.

Output power of head phone terminal / ヘッドホン出力 0.5Vr.m.s. / 33Ω

Load impedance (of speaker terminals at each channel) / 負荷

Each system ("A" system or "B" system) 4Ω ~ 16Ω

Both systems ("A" system and "B" system) 8Ω ~ 16Ω

● Pre Amplifier Section / 前置増幅器部

Input sensitivity and impedance (at 1kHz) / 入力感度

PHONO (MC) input terminals 0.3mVr.m.s. / 100Ω

PHONO (MM) input terminals 2.5mVr.m.s. / 47kΩ

The other input terminals 150mVr.m.s. / 20kΩ

Maximum input capability (at 1kHz) / 最大許容入力

PHONO (MC) input terminals (less than 0.1% THD) 21mV

PHONO (MM) input terminals (less than 0.01% THD) 210mV

Output voltage and impedance (at 1kHz) / 出力電圧

TAPE RECORDING terminals 150mVr.m.s. / 47kΩ

Frequency response (at 1W output) / 周波数特性

PHONO (MM) input terminals 20Hz ~ 20kHz ± 0.2 dB

The other input terminals D.C. ~ 200kHz ± 3 dB

Signal to noise ratio (into I.H.F. - A202 network , short circuit) / SN比

PHONO (MC) input terminals 70dB

PHONO (MM) input terminals 88dB

The other input terminals 110dB

Separation of channels (at 1kHz) / チャンネル・セパレーション

PHONO (MC) input terminals 50dB

PHONO (MM) input terminals 65dB

The others input terminals 85dB

Separation of the other sources (at 1kHz) / クロス・トーク

TUNER \Leftrightarrow PHONO (MM) 85dB

CD , TAPE \Leftrightarrow PHONO (MM) 90dB

CD , TUNER \Leftrightarrow TAPE 90dB

TAPE \Leftrightarrow TAPE 90dB

Tone control / トーン・コントロール

Bass (at 50Hz) & Treble (at 15kHz) +6dB ~ -6dB

Subsonic filter / サブソニック・フィルタ cut off 16Hz , slope 6dB / oct.

Roudness filter (at -30dB point of master volume) / ラウドネス

+6dB at 50Hz , +4dB at 10kHz

● General Section (The others) / 総合部

External Maximum consumption power of extra outlet / A.C. 外・レト

Switched maximum 100W

Unswitched total maximum 250W

Power requirements / 供給電源

AU – Ⓜ607MR A.C. 100V / 50Hz or 60Hz

AU – Ⓜ607MRX A.C. 110V / 50Hz or 60Hz

..... or A.C. 230V / 50Hz or 60Hz

Power consumption / 定格消費電力

AU – Ⓜ607MR 250W

AU – Ⓜ607MRX 340W

Dimensions (Package dimensions) / 外形寸法 (梱包時)

Width 430mm (543mm)

Height 162mm (267mm)

Depth 452mm (537mm)

Weight of solid (Packet weight) / 本体質量 (梱包時質量)

18.0kg (20.0kg)

Bulk (Volume of packet) / 梱包寸数 2-9cft / 0.078m³

●Design and specifications subject to change without notice for improvements.

●Due to local laws and regulations, this unit sold in some areas are not equipped with variable voltage selector.

●本機の意匠及び仕様の一部は、改良の為、予告無く変更する事があります。

2. SCHEMATIC DIAGRAM / 回路図 2-1-1. PRE AMPLIFIER CIRCUIT / プリ・アンプ回路

• Design and specifications subject to change without notice for improvements.
• 本機の意匠及び仕様の一部は、改良のため、予告なく変更することがあります。

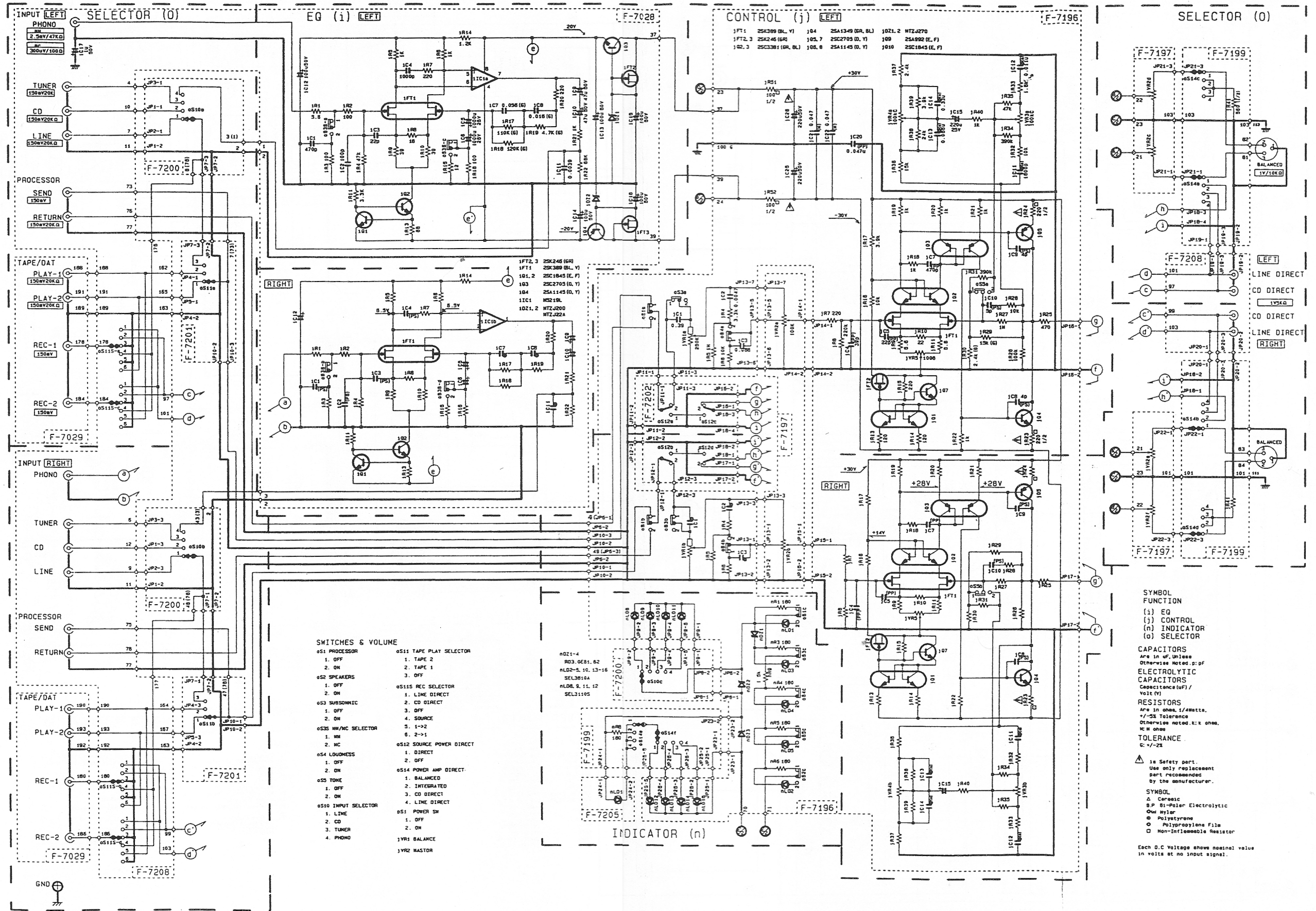

2-1-2. MAIN AMPLIFIER CIRCUIT & POWER SUPPLY CIRCUIT / パワーアンプ及び電源回路

• Design and specifications subject to change without notice for improvements.
• 本機の意匠及び仕様の一部は、改良のため、予告なく変更することがあります。

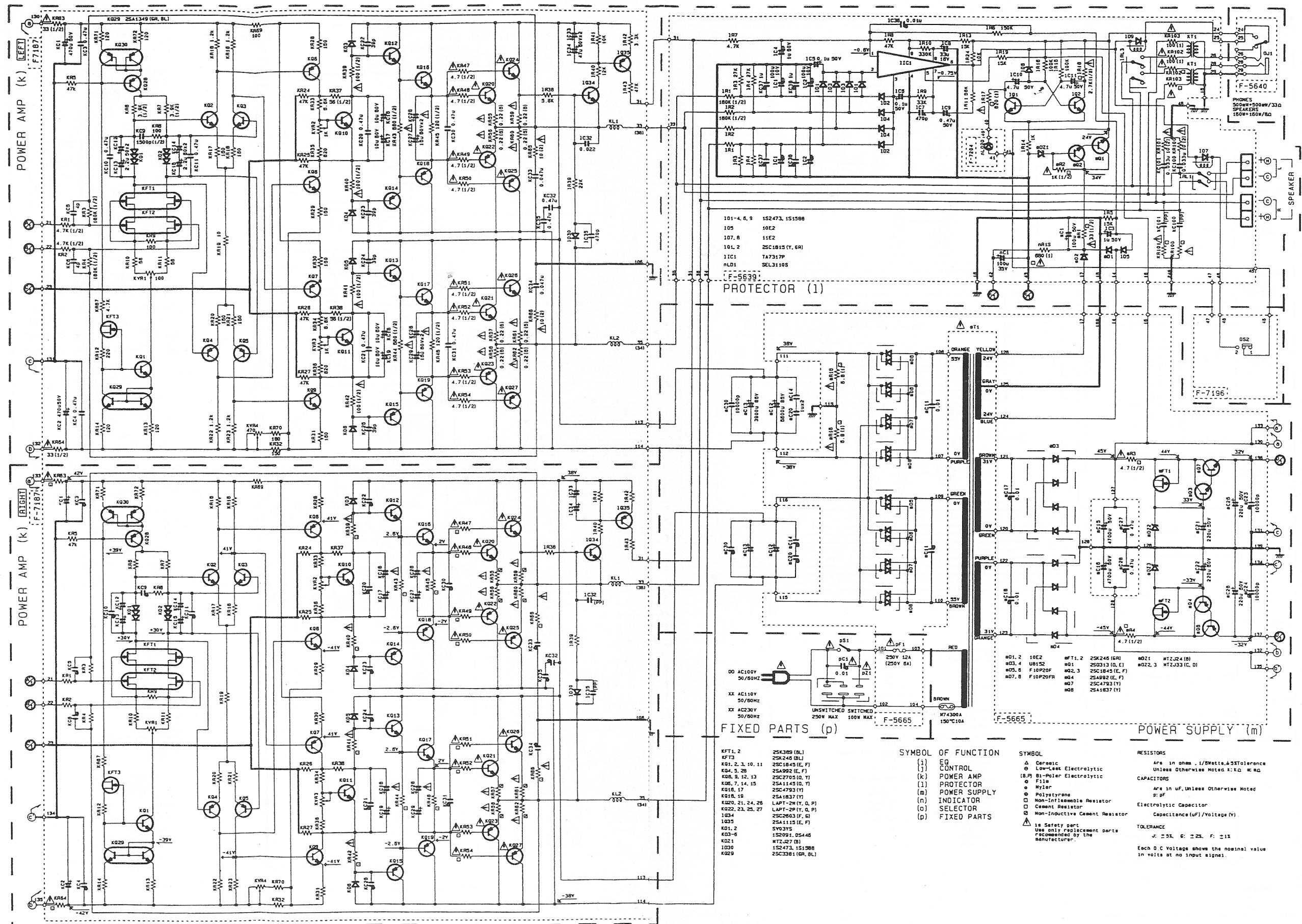
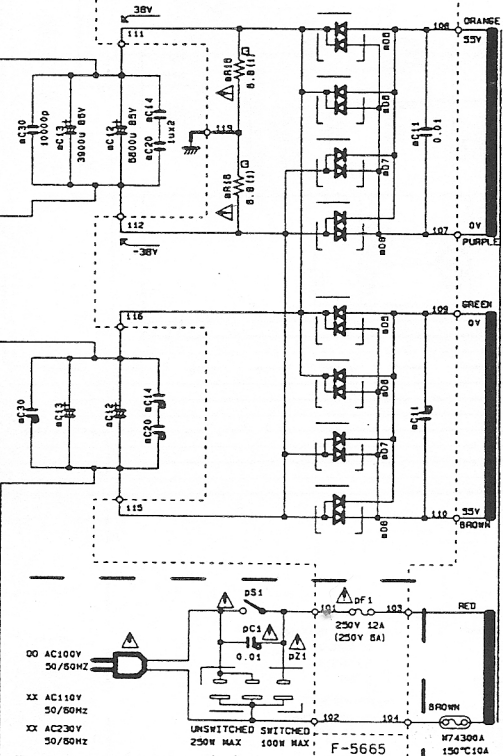

Table with 2 columns: Part Number and Description. Includes entries like 101-4, 6, 9; 105; 107, 8; 101, 2; 1C1; R101; R102.



Legend and component lists. Includes SYMBOL OF FUNCTION (EQ, CONTROL, POWER AMP, etc.), SYMBOL (C, R, etc.), RESISTORS, CAPACITORS, and TOLERANCE information.

2-2-1. PRE AMPLIFIER CIRCUIT / プリ・アンプ回路

Design and specifications subject to change without notice for improvements.
本機の意匠及び仕様の一部は、改良のため、予告なく変更することがあります。

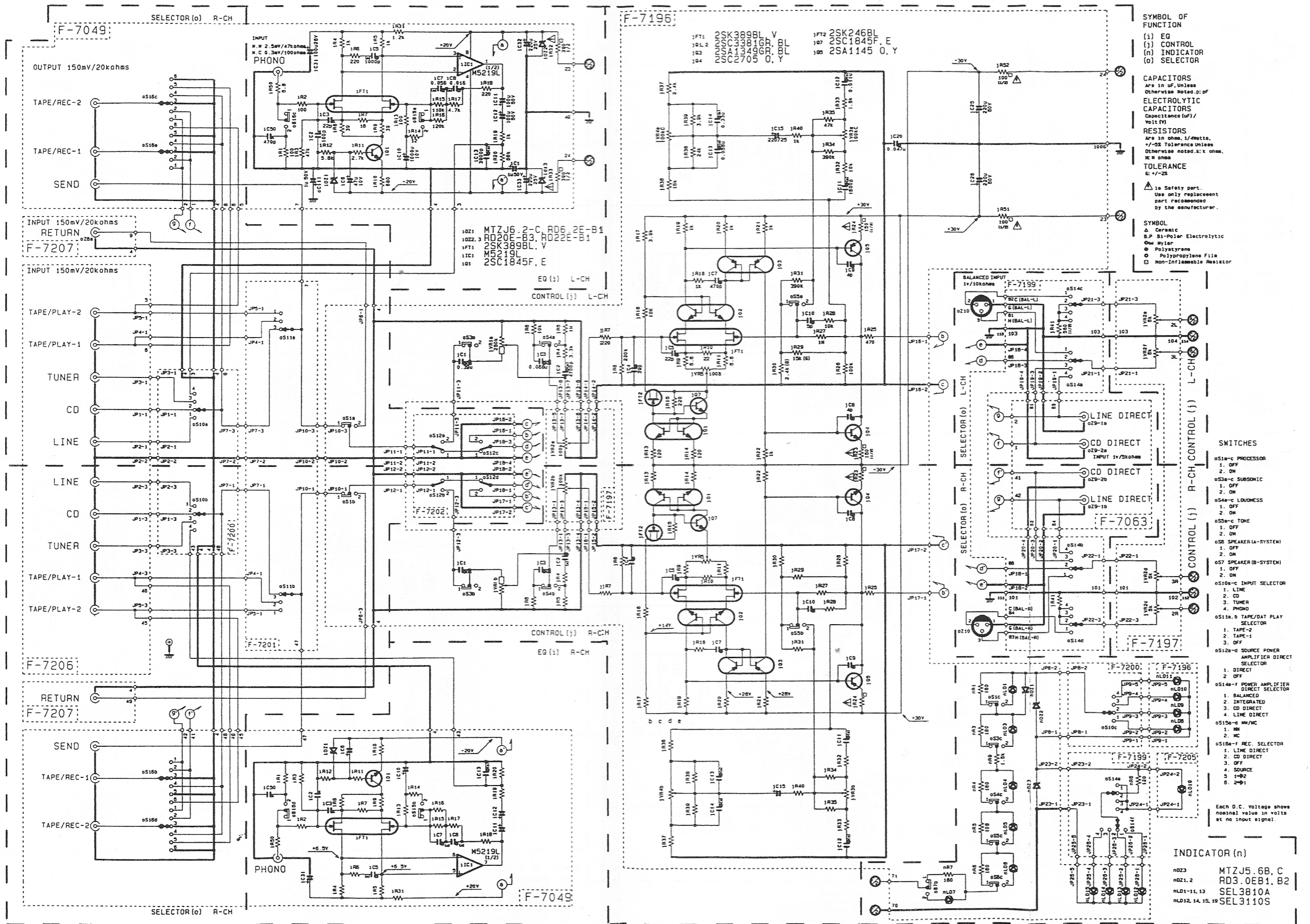

SYMBOL OF FUNCTION
(i) EQ
(j) CONTROL
(n) INDICATOR
(o) SELECTOR

CAPACITORS
Are in uF, Unless
Otherwise Noted. D: OF
ELECTROLYTIC
CAPACITORS
Capacitance (uF) /
Voltage (V)

RESISTORS
Are in ohms, 1/4watts.
1/2W Tolerance unless
Otherwise noted. K: x1000,
M: x1000000

TOLEANCE
C: +/-2%

is Safety part.
Use only replacement
part recommended
by the manufacturer.

SYMBOL
A Ceramic
B P Bipolar Electrolytic
C Mylar
D Polystyrene
E Polypropylene Film
F Non-Inflammable Resistor

- SWITCHES
o51a-c PROCESSOR
1. OFF
2. ON
o53a-c SUBSONIC
1. OFF
2. ON
o54a-c LOUDNESS
1. OFF
2. ON
o55a-c TONE
1. OFF
2. ON
o56 SPEAKER (A-SYSTEM)
1. OFF
2. ON
o57 SPEAKER (B-SYSTEM)
1. OFF
2. ON
o510a-c INPUT SELECTOR
1. LINE
2. CD
3. TUNER
4. PHONO
o511a, b TAPE/DAT PLAY
SELECTOR
1. TAPE-2
2. TAPE-1
3. OFF
o512a-d SOURCE POWER
AMPLIFIER DIRECT
SELECTOR
1. DIRECT
2. OFF
o514a-f POWER AMPLIFIER
DIRECT SELECTOR
1. BALANCED
2. INTEGRATED
3. CD DIRECT
4. LINE DIRECT
o515a-d MM/MC
1. MM
2. MC
o516a-f REC. SELECTOR
1. LINE DIRECT
2. CD DIRECT
3. OFF
4. SOURCE
5. +R2
6. +R1

INDICATOR (n)
n023 MTZJ5.6B, C
n021.2 RD3.0EB1, B2
nLD1-11, 13 SEL3810A
nLD12, 14, 15, 19 SEL3110S

2-2-2. MAIN AMPLIFIER CIRCUIT & POWER SUPPLY CIRCUIT / パワーアンプ及び電源回路

Design and specifications subject to change without notice for improvements.
本機の意匠及び仕様の一部は、改良のため、予告なく変更することがあります。

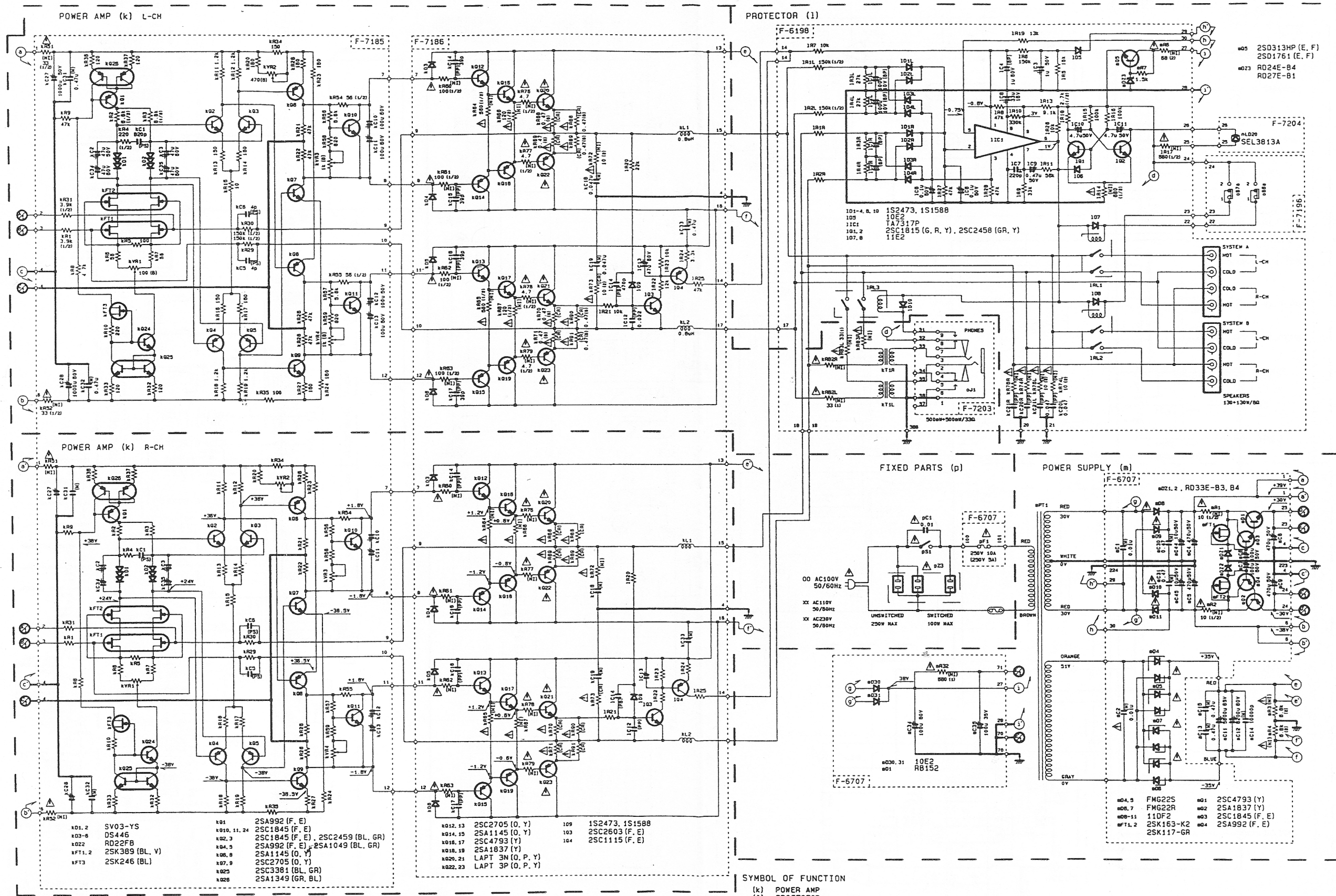

- 2SD13HP (E, F)
2SD1761 (E, F)
R024E-B4
R027E-B1

- 1S2473, 1S1588
10E2
TA7317P
2SC1815 (G, R, Y), 2SC2458 (GR, Y)
11E2

- k01.2 SV03-YS
k03-6 DS446
k022 RD22FB
kFT1.2 2SK389 (BL, Y)
kFT3 2SK246 (BL)
k01 2SA992 (F, E)
k010.11.24 2SC1845 (F, E)
k02.3 2SC1845 (F, E), 2SC2458 (BL, GR)
k04.5 2SA992 (F, E), 2SA1049 (BL, GR)
k06.8 2SA1145 (O, Y)
k07.9 2SC2705 (O, Y)
k025 2SC3381 (BL, GR)
k026 2SA1349 (GR, BL)

- k012.13 2SC2705 (O, Y)
k04.15 2SA1145 (O, Y)
k016.17 2SC4793 (Y)
k018.19 2SA1837 (Y)
k020.21 LAPT 3N (O, P, Y)
k022.23 LAPT 3P (O, P, Y)
1S2473, 1S1588
2SC2603 (F, E)
2SC1115 (F, E)

- FMG22S
FMG22R
11DF2
2SK163-K2
2SK117-GR
2SC4793 (Y)
2SA1837 (Y)
2SC1845 (F, E)
2SA992 (F, E)

SYMBOL Ceramic Capacitor, Hyler, Polystyrene, Non-Inflammable Resistor, Cement Resistor
RESISTORS Are in ohms, 1/4watts, 435Tolerance Unless Otherwise Noted. k:kilo Ohm
CAPACITORS Are in uF, Unless Otherwise Noted g:pF
Electrolytic Capacitor Capacitance (uF) / Voltage (V)
TOLERANCE G:425

is Safety part.
Use only replacement parts recommended by manufacturer.
Each D.C Voltage shows the nominal value in volts at no input signal.

SYMBOL OF FUNCTION
(k) POWER AMP
(l) PROTECTOR
(m) POWER SUPPLY
(n) INDICATOR
(o) SELECTOR
(p) FIXED PARTS

2-3-1. PRE AMPLIFIER CIRCUIT / プリ・アンプ回路

607MR

607MRX

• Design and specifications subject to changes without notice for improvements.
 • 本機の意匠及び仕様の一部は、改良のため、予告なく変更することがあります。

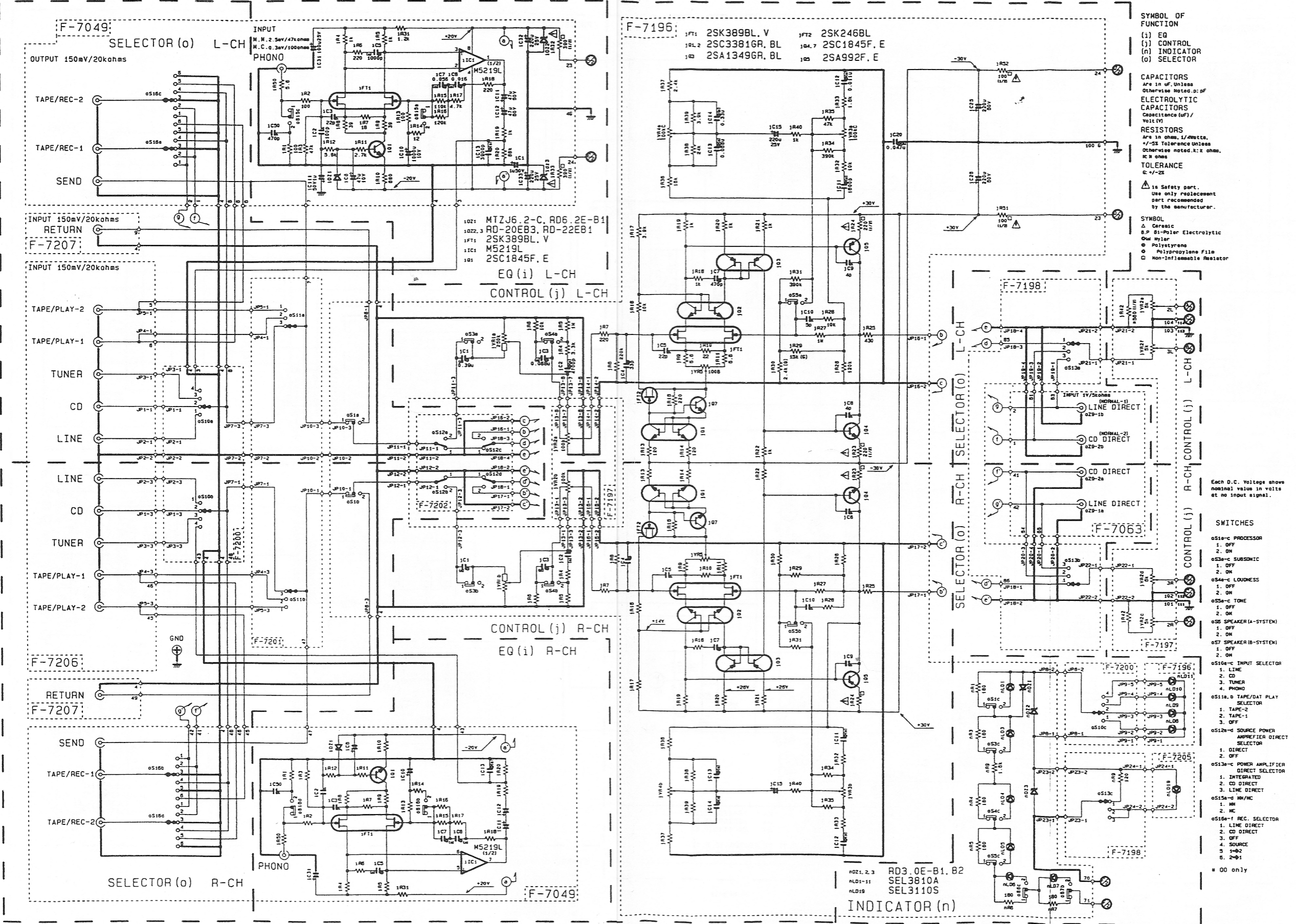

- SYMBOL OF FUNCTION**
- (i) EQ
 - (j) CONTROL
 - (n) INDICATOR
 - (o) SELECTOR
- CAPACITORS**
 Are in μ F, unless otherwise noted. μ = μ F
- ELECTROLYTIC CAPACITORS**
 Capacitance (μ F) / Volt (V)
- RESISTORS**
 Are in ohms, k = 10^3 ohms, M = 10^6 ohms, \pm tolerance unless otherwise noted. k : k ohms, M : M ohms
- TOLERANCE**
 \pm %
- is Safety part.**
 Use only replacement part recommended by the manufacturer.
- SYMBOL**
 Δ Ceramic
 B.P. Bi-Polar Electrolytic
 \square Mylar
 \circ Polystyrene
 \square Polypropylene Film
 \square Non-Inflammable Resistor
- SWITCHES**
- OS100-c PROCESSOR
 - OFF
 - ON
 - OS30-c SUBSONIC
 - OFF
 - ON
 - OS40-c LOUDNESS
 - OFF
 - ON
 - OS50-c TONE
 - OFF
 - ON
 - OS60 SPEAKER (A-SYSTEM)
 - OFF
 - ON
 - OS70 SPEAKER (B-SYSTEM)
 - OFF
 - ON
 - OS100-c INPUT SELECTOR
 - LINE
 - CD
 - TUNER
 - PHONO
 - OS110-d TAPE/DAT PLAY SELECTOR
 - TAPE-2
 - TAPE-1
 - OFF
 - OS120-d SOURCE POWER AMPLIFIER DIRECT SELECTOR
 - DIRECT
 - OFF
 - OS130-c POWER AMPLIFIER DIRECT SELECTOR
 - INTEGRATED
 - CD DIRECT
 - LINE DIRECT
 - OS150-d REC. SELECTOR
 - LINE
 - MC
 - OS160-f REC. SELECTOR
 - LINE DIRECT
 - CD DIRECT
 - OFF
 - SOURCE
 - 1- ϕ 2
 - 2- ϕ 1
- Each D.C. Voltage shows nominal value in volts at no input signal.**
- # 00 only**

2-3-2. MAIN AMPLIFIER CIRCUIT & POWER SUPPLY CIRCUIT / パワーアンプ及び電源回路

• Design and specifications subject to change without notice for improvements.
 • 本機の意匠及び仕様の一部は、改良のため、予告なく変更することがあります。

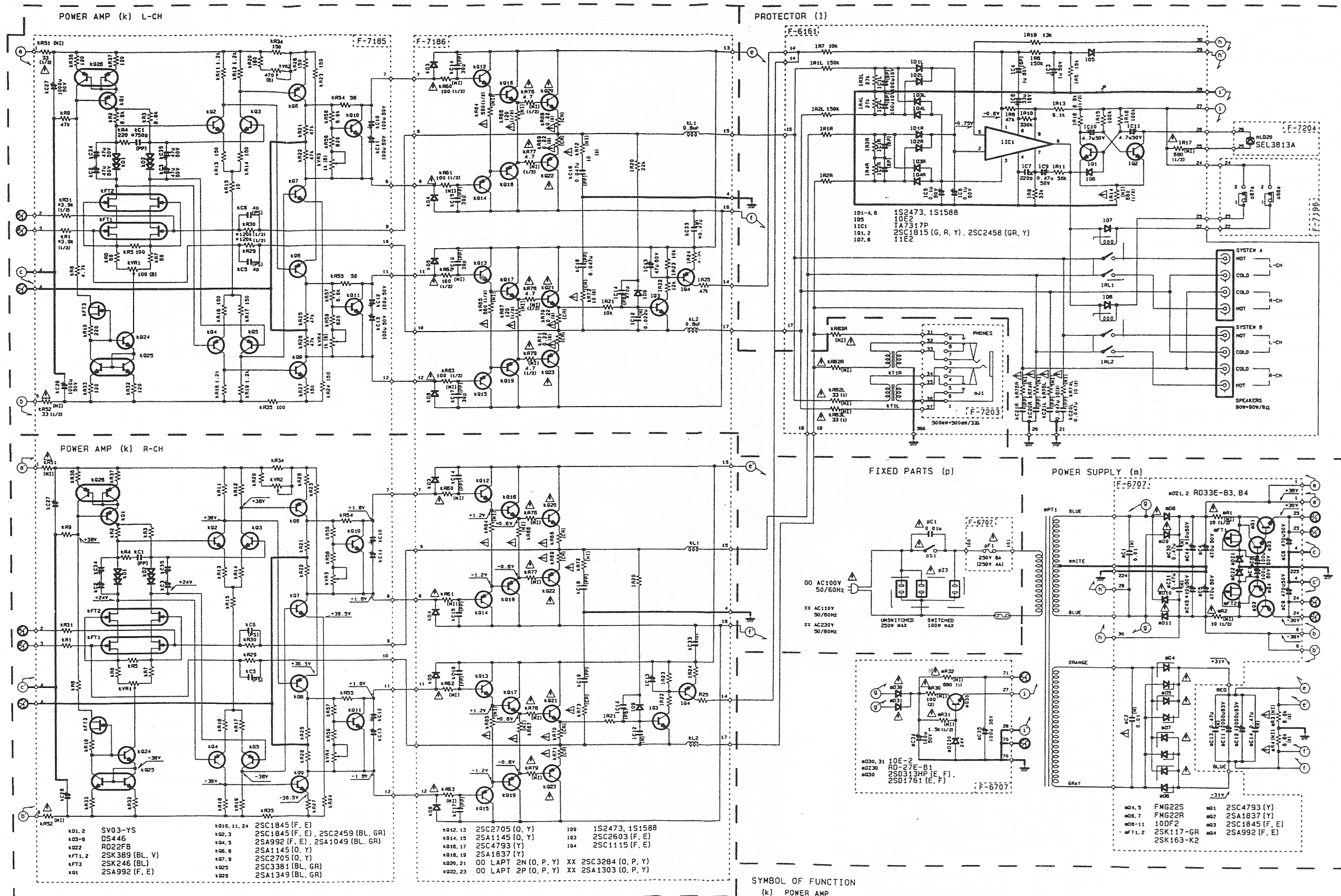

SYMBOL OF FUNCTION

(k) POWER AMP
 (I) PROTECTOR
 (m) POWER SUPPLY
 (n) INDICATOR
 (o) SELECTOR
 (p) FIXED PARTS

SYMBOL
 (N) Ceramic Capacitor
 (M) Mylar
 (PS) Polystyrene
 (NI) Non-Inflammable Resistor
 (CR) Carbon Resistor

RESISTORS
 Are in ohms, 1/4watts, 4% tolerance unless otherwise noted. 1/2W 5% tolerance

CAPACITORS
 Are in uF, unless otherwise noted

Electrolytic Capacitor
 Capacitance (uF) / Voltage (V)

TOLEANCE
 5% 425

△ is Safety part.
 Use only replacement parts recommended by manufacturer.

00 only
 Each D.C. Voltage shows the nominal value in volts at no input signal.

3. ADJUSTMENT / 調整方法

3-1. AU-α907MR and AU-α907MRX

- **Note / 条件** : 1. an Atmosphere Temp / 周囲温度 18° C-28° C
- 2. VOLUME / 音量調節器 Minimum / 最小
- 3. SPEAKERS switch / スピーカー・スイッチ Pushed On / 入
- 4. POWER AMP. DIRECT OPERATION switch Normal
 パワー・アンプ・ダイレクト操作スイッチ " Normal "
- 5. And Setting " Direct Current Millivolt Meter " with " Probe ".
 併せて、直流小電圧計と探針器を準備します。

3-1-1. Bias Current of Main Amplifiers Adjustment

/ 主増幅器のバイアス電流調整

- Adjust the bias current of main amplifiers on both left channel and right channel.!!
- 左右両側のチャンネルの主増幅器のバイアス電流を調整します。

Step 手順	Subject 項目	Connection 接続方法	Adjustment Point 調整箇所	Adjust for 調整	Remarks 備考
1	Hot side (Non Inverting) 非反転増幅器側	Put the high impedance probe between " Hot Out " terminal and " Hot Bias " terminal.	kVR3	8.8mV±1mV	POWE AMP. DIRECT OPE. "NORMAL"
2	Cold side (Inverting) 反転増幅器側	Put the high impedance Probe between " Cold Out " terminal and " Cold Bias " terminal.	kVR2	8.8mV±1mV	パワー・アンプ ダイレクト操作 "NORMAL"
3	Adjust the bias current of main amplifiers in a similar way on the other channel too. 他方のチャンネルも同様に主増幅器のバイアス電流の調整をします。				

3-1-2. Direct Current Off Set Voltage of Main Amplifiers Adjustment

/ 主増幅器の直流中点電位調整

- Adjust the bias current of main amplifiers on both left channel and right channel.!!
- 左右両側のチャンネルの主増幅器のバイアス電流を調整します。

Step 手順	Subject 項目	Connection 接続方法	Adjustment Point 調整箇所	Adjust for 調整	Remarks 備考
1	Hot side (Non Inverting) 非反転増幅器側	Put the high impedance probe between " Hot Out " terminal and " Hot Bias " terminal.	kVR4	0mV±30mV	POWE AMP. DIRECT OPE. "NORMAL"
2	Cold side (Inverting) 反転増幅器側	Put the high impedance.Probe between " Hot Out " (speaker) terminal and " Cold Out " (speaker) terminal.	kVR1	0mV±30mV	パワー・アンプ ダイレクト操作 "NORMAL"
3	Adjust the bias current of main amplifiers in a similar way on the other channel too. 他方のチャンネルも同様に主増幅器のバイアス電流の調整をします。				

3-1-3. Direct Current Off Set Voltage of Pre Amplifiers Adjustment

／ 前置増幅器の直流中点電位調整

• Adjust the off set voltage of pre amplifiers on both left channel and right channel.!!

Step 手順	Subject 項目	Connection 接続方法	Adjustment Point 調整箇所	Adjust for 調整	Remarks 備考
1	Pre Amp. Off Set Voltage 前置増幅器中点 電位調整	Put the high impedance probe between " Hot Out " (speaker) terminal and " Cold Out " (speaker) terminal.	JVR5	0mV±30mV	Input Selector "CD" Input Terminal "Short"
2	Adjust the bias current of main amplifiers in a similar way on the other channel too. 他方のチャンネルも同様に主増幅器のバイアス電流の調整をします。				

CAUTION : Must not Touch (Electrically Short) Screw Driver and Chassis if be Using it Made of Metals.

注意 : 金属製のドライバーを使用する場合は、ドライバーの金属部分が調整穴の筐体に触れない様にして下さい。

3-1-4. Pre Heating this amplifier and the Real Adjustment

／ 増幅器の事前加熱（熱平衡状態化）と本調整

- **Note** / 条件 : 1. Input Selector / 入力切り替え " CD "
- 2. Speaker Terminals Connecting Dummy Load at 8Ω on Both Channels.
／スピーカー端子 8Ωの負荷抵抗器を両方のチャンネルに接続する。
- 3. Put the feed " Sine Wave " signal at 20kHz from " CD " terminals on both channels.
／20kHzの正弦波信号を" CD " 端子より両チャンネルに印加します。
- 4. Turn " Volume " knob to clockwise to get 16.8Vr.m.s. (35W / 8Ω) output on speaker terminals
both channels.
両方のスピーカー端子より 16.8V (実効値) [35W / 8Ω] の出力が得られる様に時計廻り方向にボリュームつまみを廻します。
- 5. Re-adjust from " 3-1-1. " to " 3-1-3. " twice for real adjustment to the amplifier.
本調整の為、" 3-1-1. " から " 3-1-3. " 迄を二度再調整します。

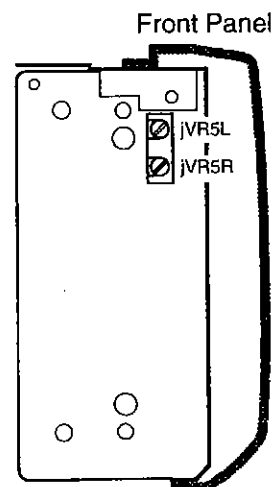
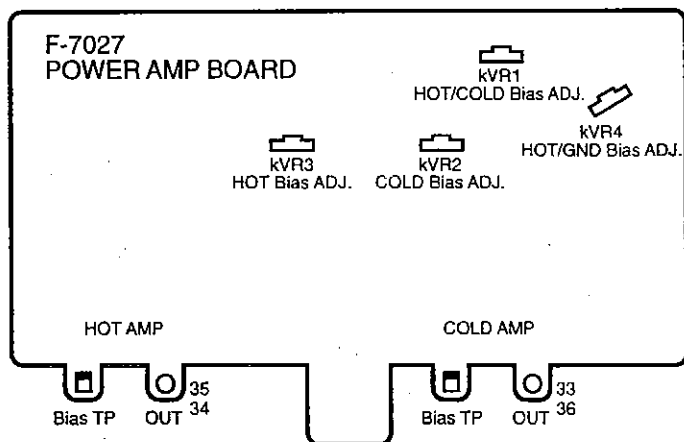

α607MR**α707MR****α607MRX****α707MRX**

3-2. AU-α707MR , AU-α607MR , AU-α707MRX and AU-α607MRX

- **Note / 条件** : 1. an Atmosphere Temp / 周囲温度 18°C~28°C
 2. VOLUME / 音量調節器 **Minimum / 最小**
 3. SPEAKERS " A " switch / スピーカー A スイッチ **Pushed On / 入**
 4. POWER AMP. DIRECT OPERATION switch **Normal**
 パワー・アンプ・ダイレクト操作スイッチ **" Normal "**
 5. And Setting " Direct Current Millivolt Meter " with " Probe ".
 併せて、直流小電圧計と探針器を準備します。

3-2-1. Bias Current of Main Amplifiers Adjustment

／ 主増幅器のバイアス電流調整

- Adjust the bias current of main amplifiers on both left channel and right channel.!!
- 左右両側のチャンネルの主増幅器のバイアス電流を調整します。

Step 手順	Subject 項目	Connection 接続方法	Adjustment Point 調整箇所	Adjust for 調整	Remarks 備考
1	Hot side (Non Inverting) 非反転増幅器側	Put the high impedance probe between " Hot Out " terminal and " Hot Emitter " terminal.	kVR3	10mV±1mV	POWE AMP DIRECT OPE. "NORMAL"
2	Cold side (Inverting) 反転増幅器側	Put the high impedance probe between " Cold Out " terminal and " Cold Emitter " terminal.	kVR4	10mV±1mV	パワー・アンプ ダイレクト操作 "NORMAL"
3	Adjust the bias current of main amplifiers in a similar way on the other channel too. 他方のチャンネルも同様に主増幅器のバイアス電流の調整をします。				

COMMENTS : Test Pin Array No. 1 is " Cold Out ", No. 2 is " Cold Emitter ", No. 3 is " Grand ", No. 4 is " Hot Emitter ", No. 5 is " Hot Out " .

注 釈 : テスト・ピン番号 1 番は " Cold Out ", 2 番は " Cold Emitter ", 3 番は " Grand ", 4 番は " Hot Emitter ", 5 番は " Hot Out " です。

3-2-2. Direct Current Off Set Voltage of Main Amplifiers Adjustment

／ 主増幅器の直流中点電位調整

- Adjust the bias current of main amplifiers on both left channel and right channel.!!
- 左右両側のチャンネルの主増幅器のバイアス電流を調整します。

Step 手順	Subject 項目	Connection 接続方法	Adjustment Point 調整箇所	Adjust for 調整	Remarks 備考
1	Hot side (Non Inverting) 非反転増幅器側	Put the high impedance probe between " Hot Out " (speaker) terminal and " GND " terminal.	kVR2	0mV±30mV	POWE AMP DIRECT OPE. "NORMAL"
2	Cold side (Inverting) 反転増幅器側	Put the high impedance probe between " Cold Out " (speaker) terminal and " Cold Out " (speaker) terminal.	kVR1	0mV±30mV	パワー・アンプ ダイレクト操作 操作スイッチ "NORMAL"
3	Adjust the bias current of main amplifiers in a similar way on the other channel too. 他方のチャンネルも同様に主増幅器のバイアス電流の調整をします。				

3-2-3. Direct Current Off Set Voltage of Pre Amplifiers Adjustment

／ 前置増幅器の直流中点電位調整

- Adjust the bias current of main amplifiers on both left channel and right channel.!!
- 左右両側のチャンネルの主増幅器のバイアス電流を調整します。

Step 手順	Subject 項目	Connection 接続方法	Adjustment Point 調整箇所	Adjust for 調整	Remarks 備考
1	Pre Amp. Off Set Voltage 前置増幅器中点 電位調整	Put the high impedance probe between " Hot Out " (Speaker) terminal and " Cold Out " (Speaker) terminal.	jVR5	0mV±30mV	Input Selector "CD" Input Terminal "Short"
2	Adjust the bias current of main amplifiers in a similar way on the other channel too. 他方のチャンネルも同様に主増幅器のバイアス電流の調整をします。				

CAUTION : Must not Touch (Electrically Short) Screw Driver and Chassis if be Using it Made of Metals.

注意 : 金属製のドライバーを使用する場合は、ドライバーの金属部分が調整穴の匡体に触れない様にして下さい。

3-2-4. Pre Heating this amprifier and the Real Adjustment

／ 増幅器の事前加熱（熱平衡状態化）と本調整

- **Note / 条件 :** 1. Input Selector / 入力切り替え " CD "
- 2. Speaker Terminals Connecting Dummy Load at 8Ω on Both Channels.
／スピーカー端子 8Ωの負荷抵抗器を両方のチャンネルに接続する。
- 3. Put the feed " Sine Wave " signal at 20kHz from " CD " terminals on both channels.
／20kHzの正弦波信号を" CD " 端子より両チャンネルに印加します。
- 4. Turn " Volume " knob to clockwise to get 16.8Vr.m.s. (35W / 8Ω) output on speaker terminals both channels.
両方のスピーカー端子より 16.8V (実効値) [35W / 8Ω] の出力が得られる様に時計廻り方向にボリューム摘みを廻します。
- 5. Re-adjust from " 3-1-1. " to " 3-1-3. " twice for real adjustment to the amplifier.
本調整の為、" 3-1-1. " から " 3-1-3. " 迄を二度再調整します。

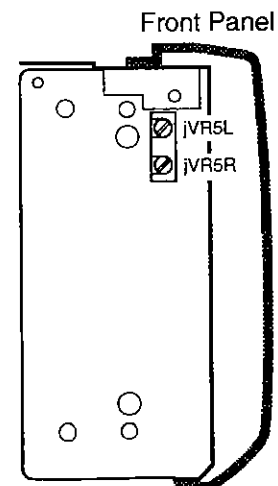
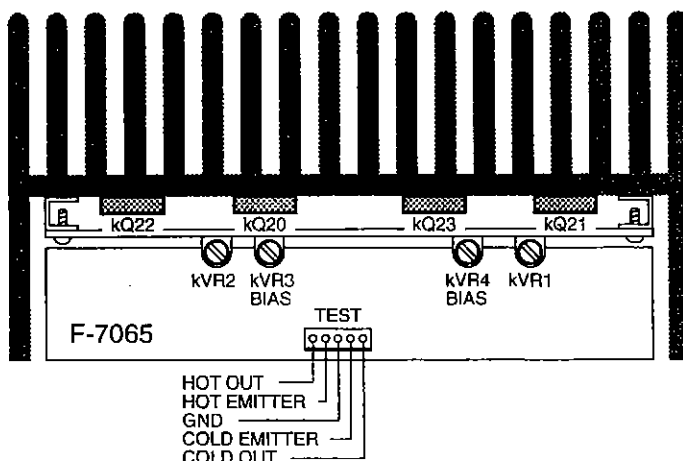

4 . INTERIOR BLOCK DIAGRAM & TERMINAL FUNCTION OF ICs

/ 使用 IC の内部ブロック図及び端子機能

- TA7317P <SPEAKER PROTECTION CIRCUIT> / スピーカー保護回路

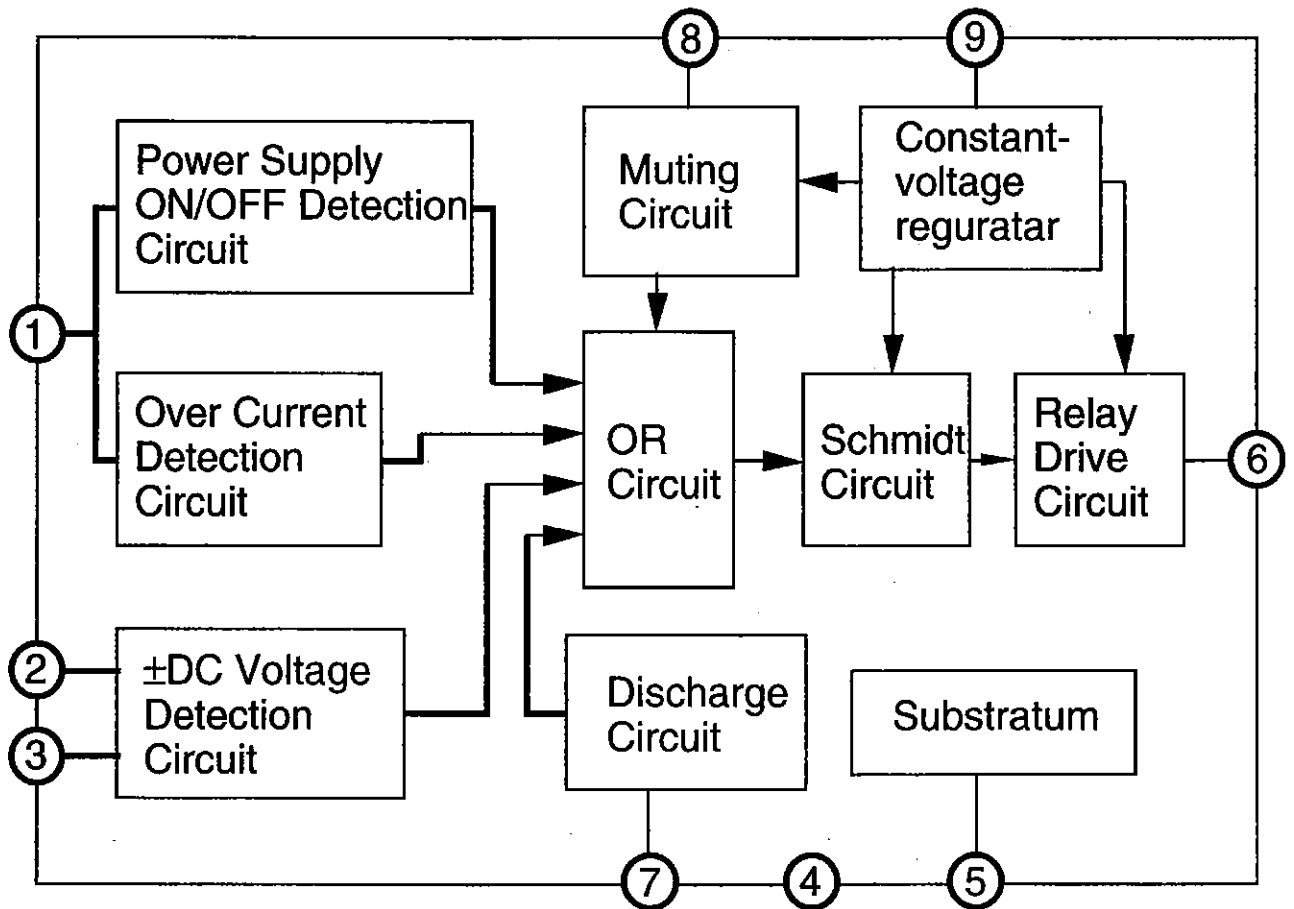

5. PARTS LOCATION ON BOARD

／プリント基板の部品配置図

- F-5639 SPEAKER PROTECTION BOARD / スピーカー保護回路基板
(COMPONENT SIDE VIEW)

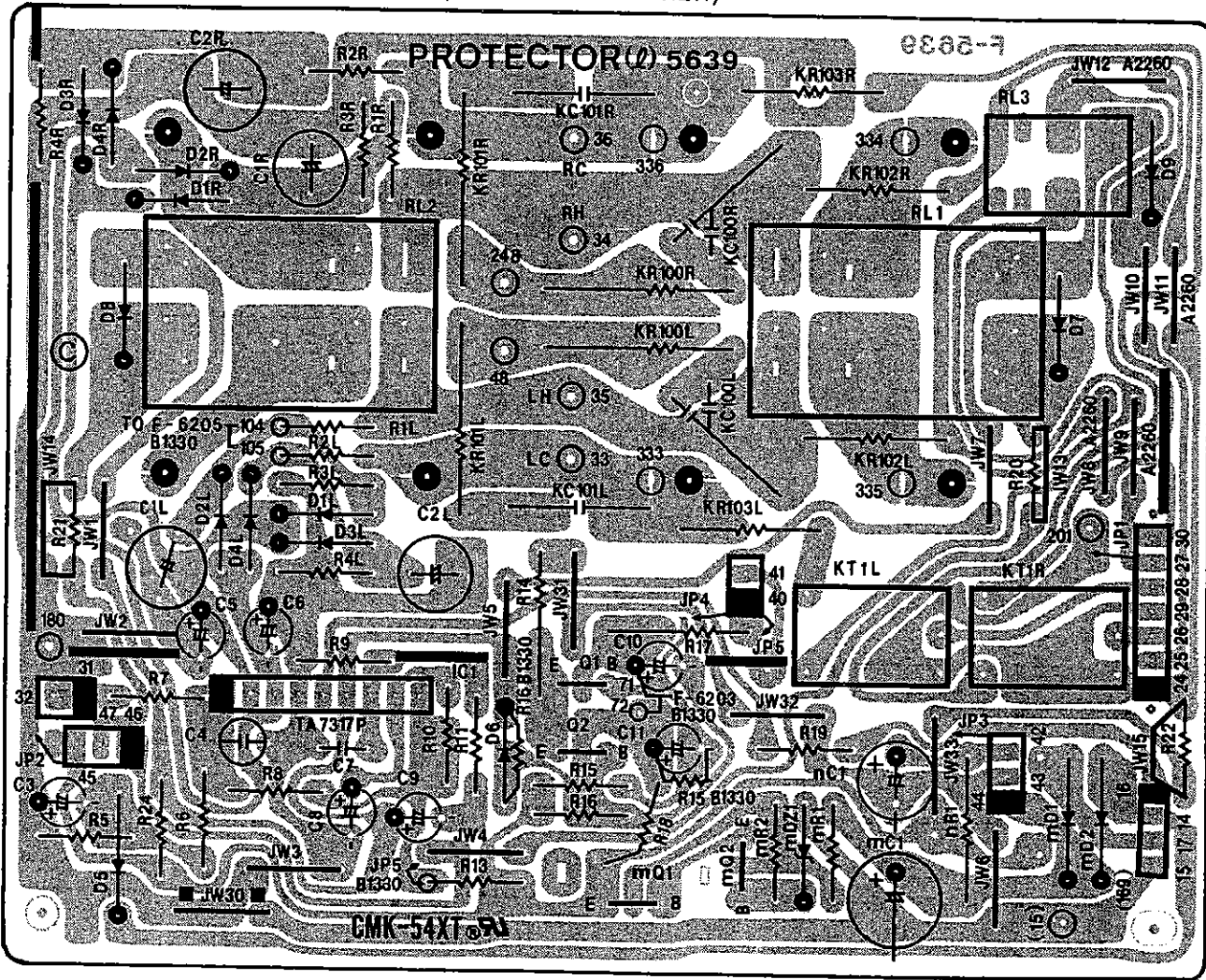

- F-5640 HEAD-PHONE TERMINAL BOARD / ヘッド・ホン端子基板

(COMPONENT SIDE VIEW)

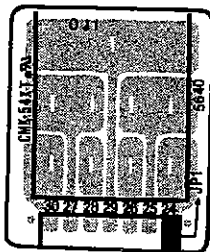

- F-7029 AUDIO TERMINALS BOARD / 入出力端子基板

(COMPONENT SIDE VIEW)

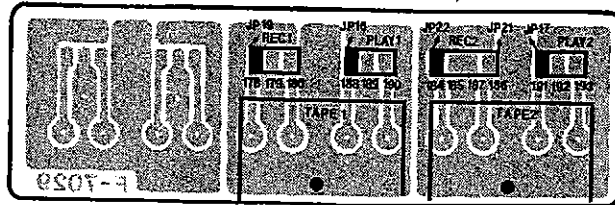

907MR

907MRX

● F-5665 POWER SUPPLY BOARD / 電源基板 (COMPONENT SIDE VIEW)

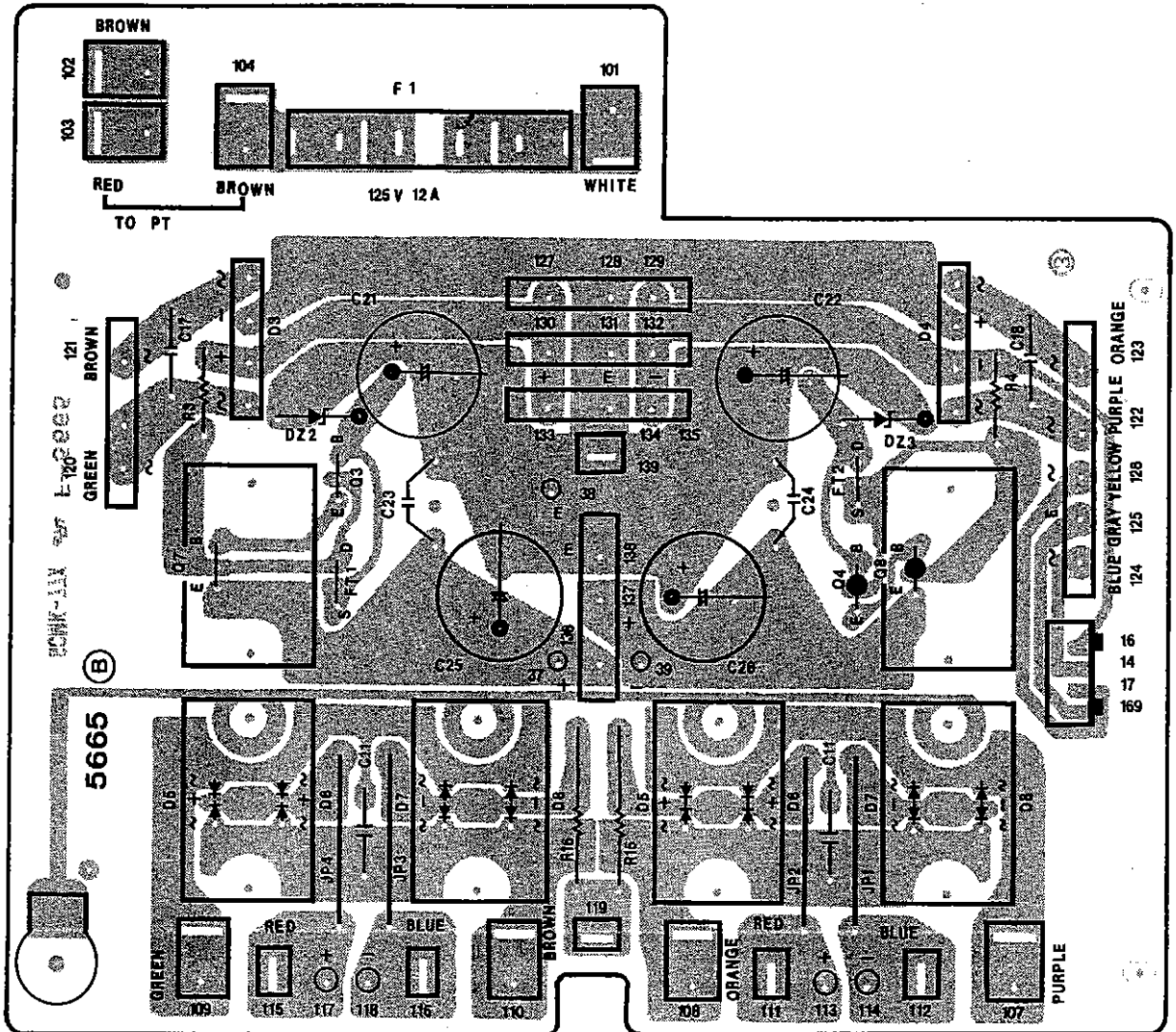

● F-7028 PHONO EQUALIZATION AMPLIFIER BOARD / イコライザー基板 (COMPONENT SIDE VIEW)

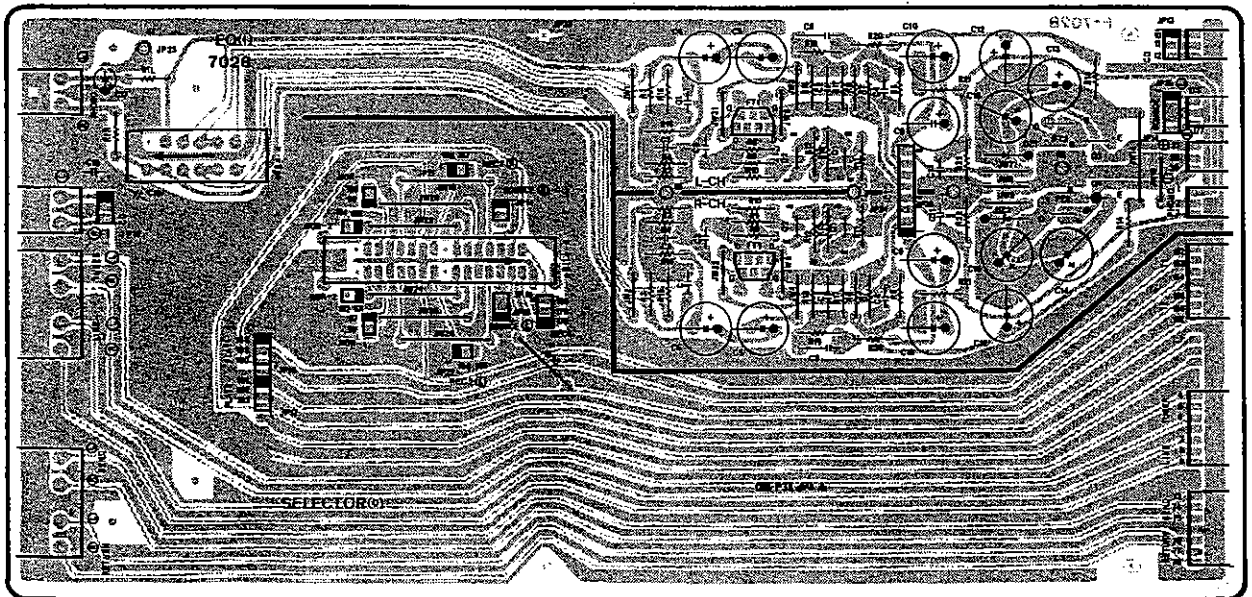

☉907MRX

☉607MRX

☉907MR

☉607MR

● F-7187 MAIN AMPLIFIER BOARD / 主増幅回路基板
 (for AU-☉907MR/MRX) (COMPONENT SIDE VIEW)

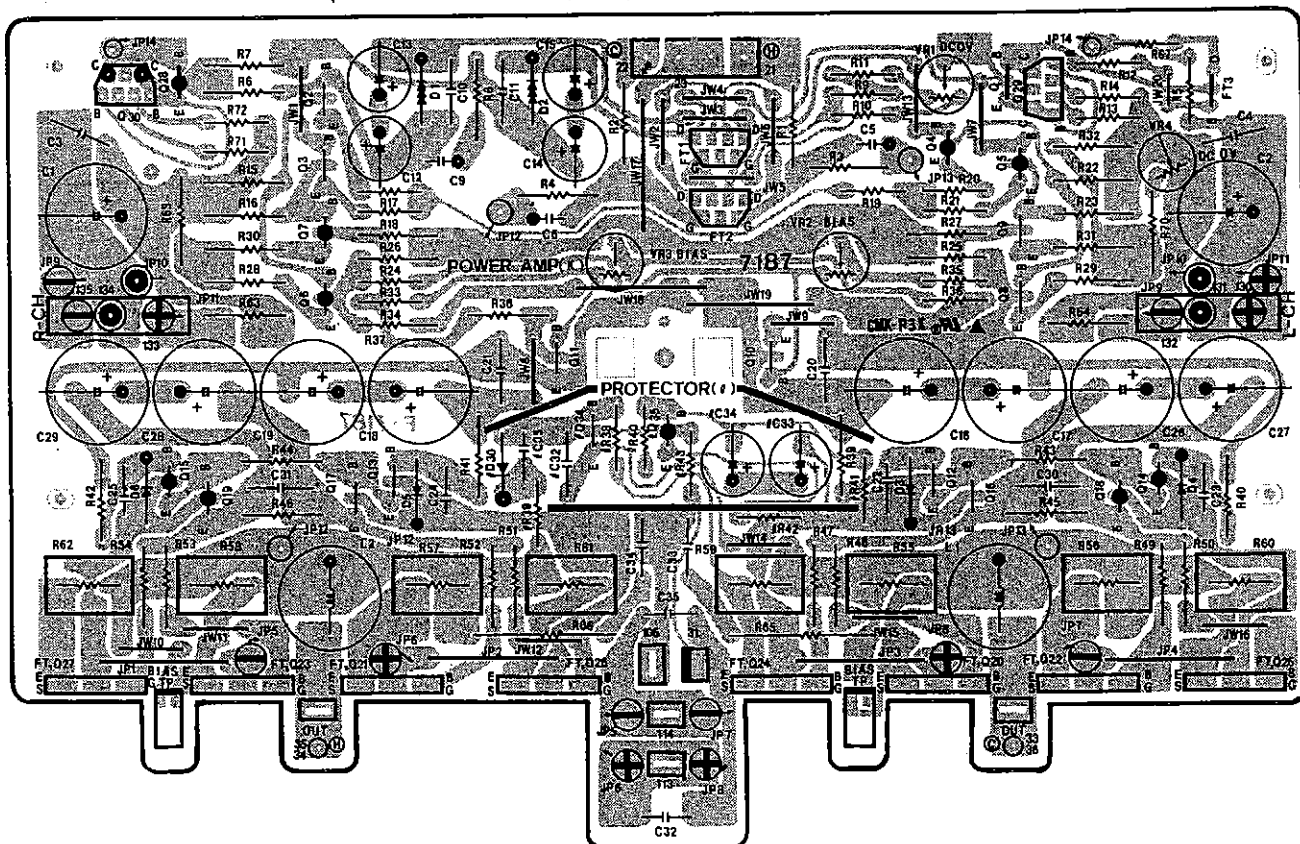

● F-6161 SPEAKER PROTECTION BOARD / スピーカー保護回路基板
 (for AU-☉607MR/MRX) (COMPONENT SIDE VIEW)

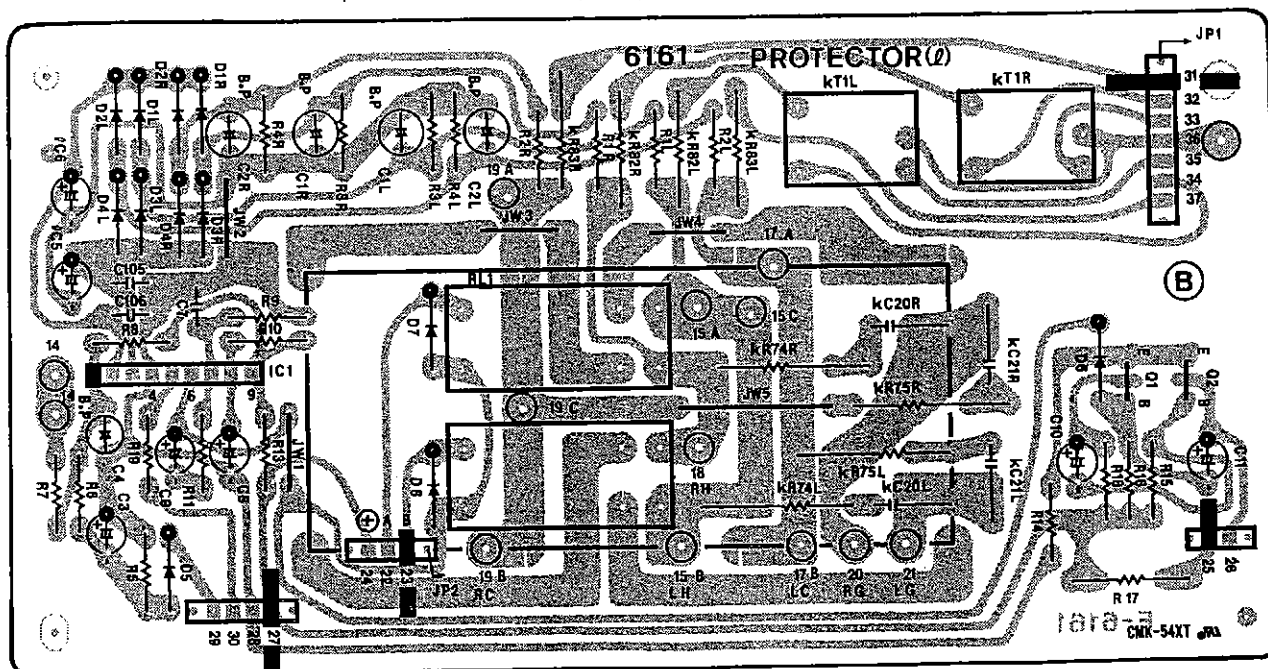

④707MRX

④607MRX

④707MR

④607MR

● F-7049 PHONO EQUALIZATION AMPLIFIER BOARD / イコライザー基板
 (COMPONENT SIDE VIEW)

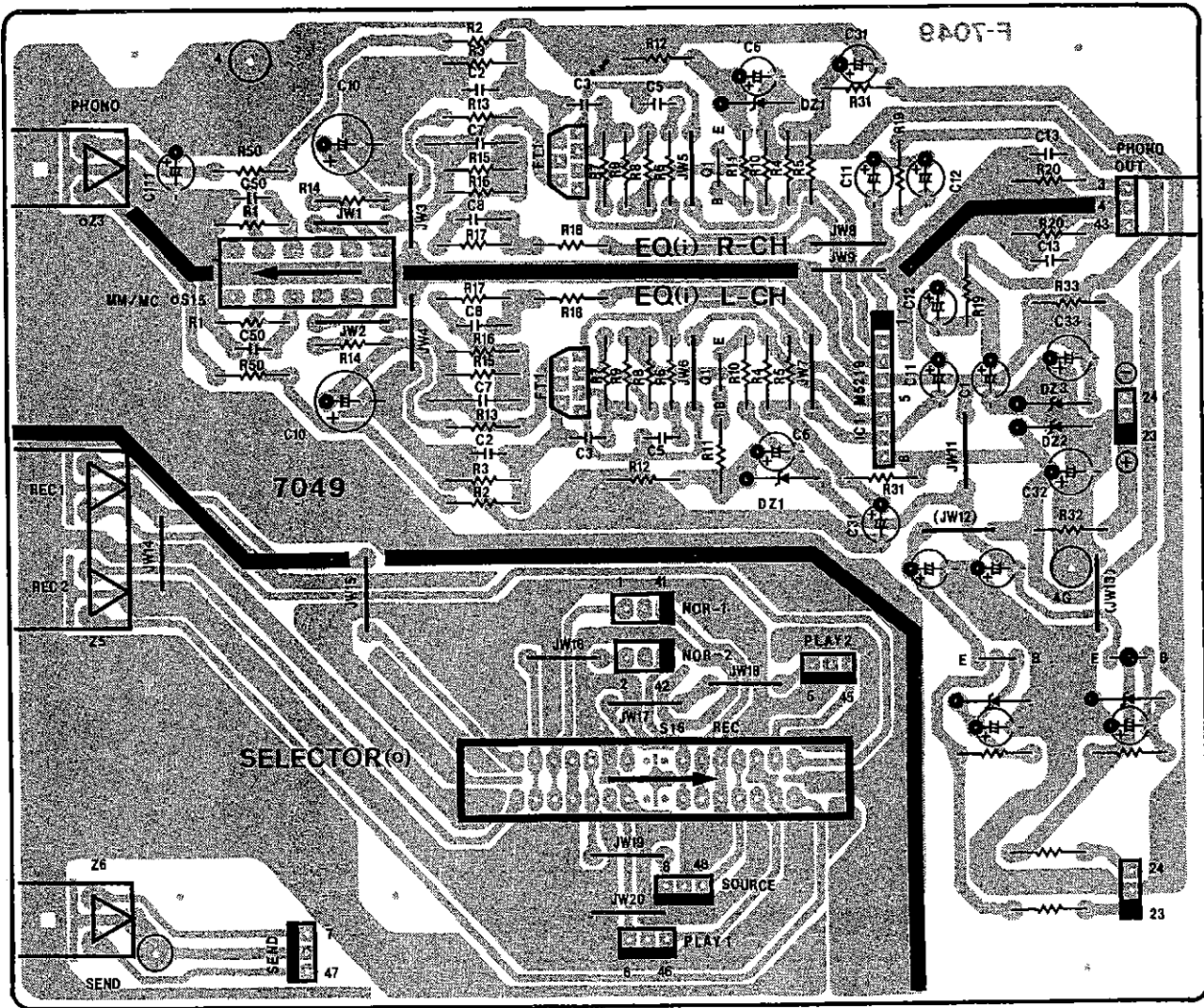

● F-7063 INPUT TERMINALS BOARD / 入力端子基板
 (for AU-④707MR/MRX & AU-④607MR/MRX) (COMPONENT SIDE VIEW)

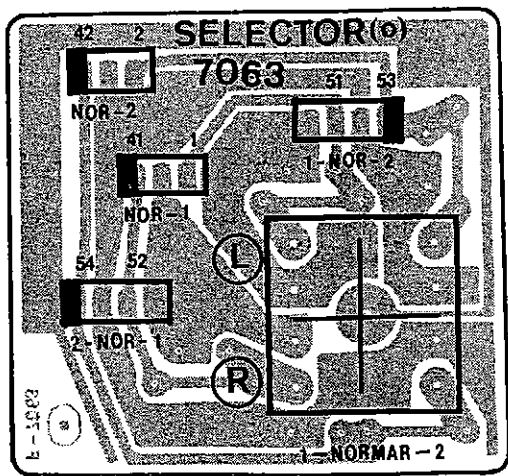

607MR

707MR

607MRX

707MRX

● F-7185 DRIVER STAGE of MAIN AMPLIFIER BOARD / 主增幅回路基板

(COMPONENT SIDE VIEW)

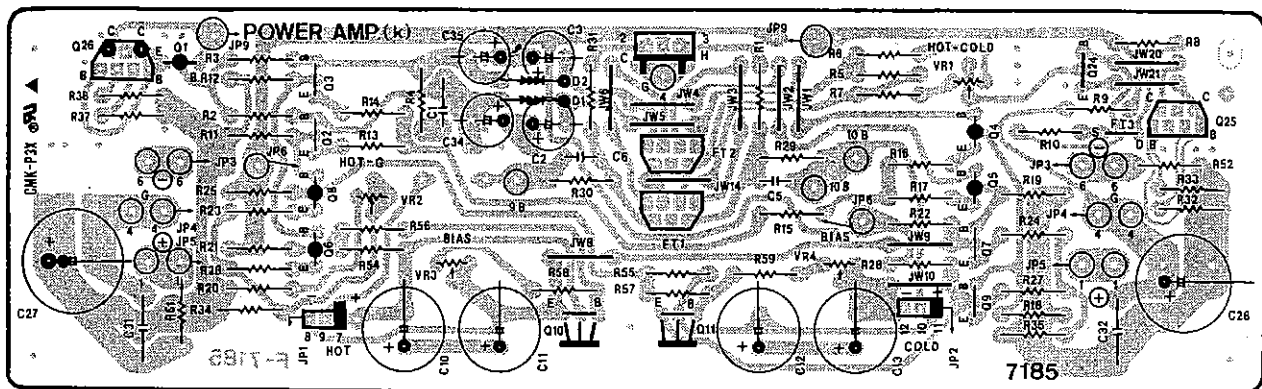

● F-7186 POWER STAGE of MAIN AMPLIFIER BOARD / 主增幅回路基板

(COMPONENT SIDE VIEW)

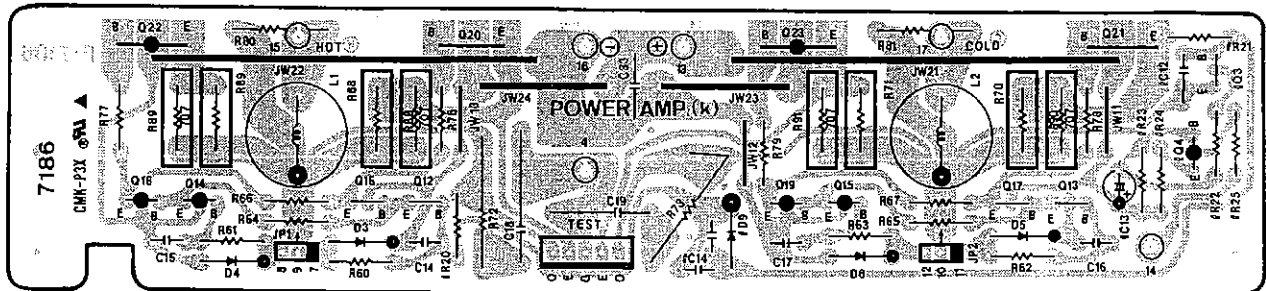

● F-7196 PRE AMPLIFIER BOARD / 前置増幅回路基板

(COMPONENT SIDE VIEW)

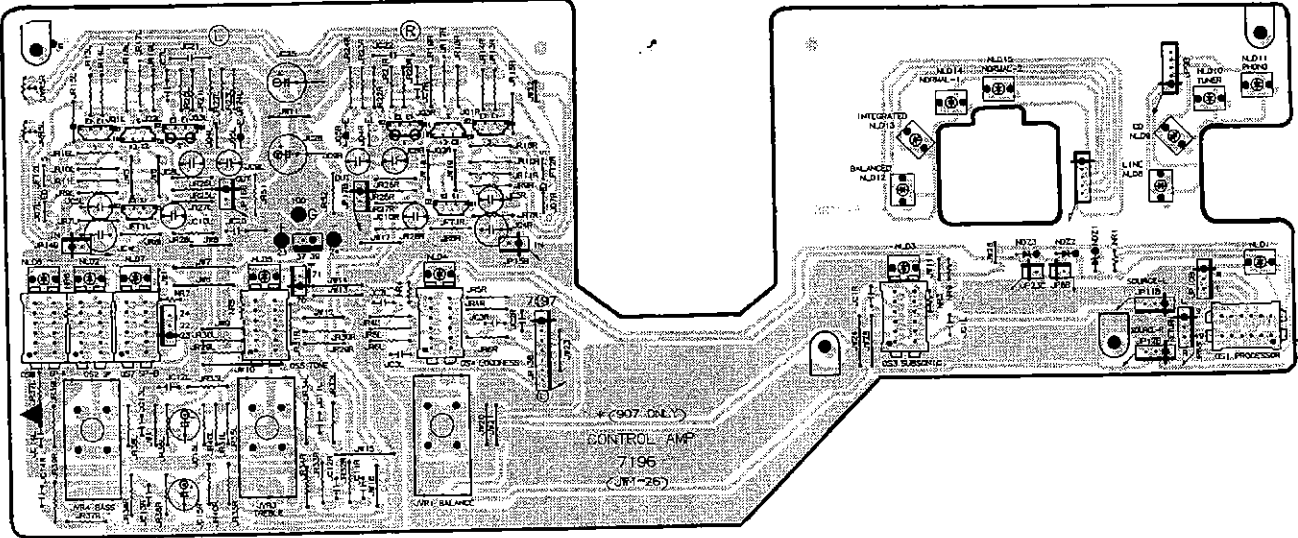

● F-7197 MASTER VOLUME BOARD / 音量調節器基板

(COMPONENT SIDE VIEW)

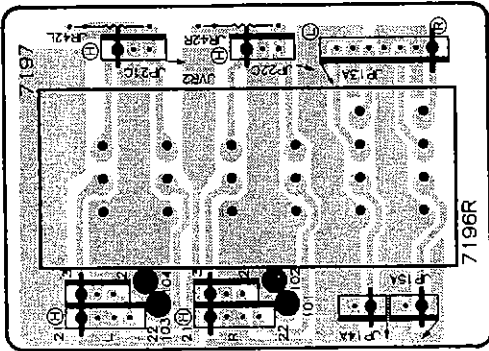

● F-7198 P.-AMP. DIRECT SELECT BOARD / パワー・アンプ・ダイレクト切換基板

(for AU-ⓧ607MR/MRX)
(COMPONENT SIDE VIEW)

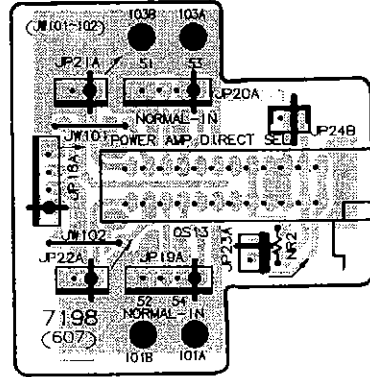

● F-7199 P.-AMP. DIRECT SELECT BOARD / パワー・アンプ・ダイレクト切換基板

(for AU-ⓧ907MR/MRX & AU-ⓧ707MR/MRX)
(COMPONENT SIDE VIEW)

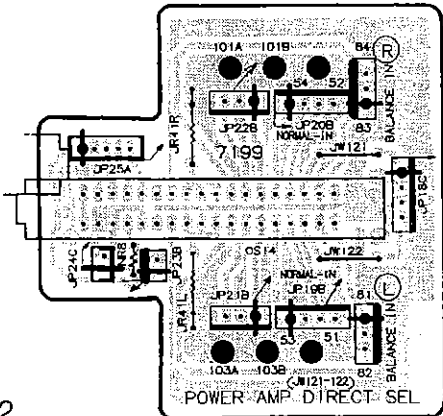

● F-7200 INPUT SELECT BOARD / 入力切換基板

(COMPONENT SIDE VIEW)

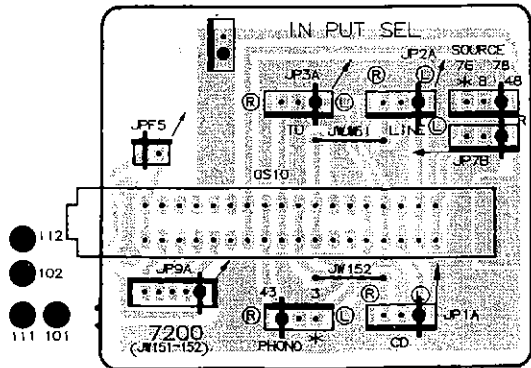

607MR

707MR

907MR

607MRX

707MRX

907MRX

● F-7201 TAPE MONITOR SELECT BOARD / テープ系入力切換基板

(COMPONENT SIDE VIEW)

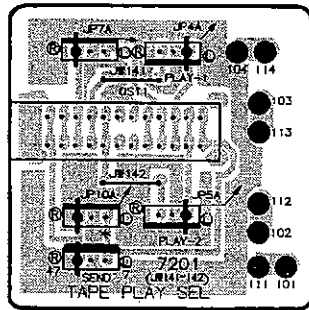

● F-7202 SOURCE P.-AMP. DIRECT SELECT BOARD / ソース・パワー・ダイレクト切換基板

(COMPONENT SIDE VIEW)

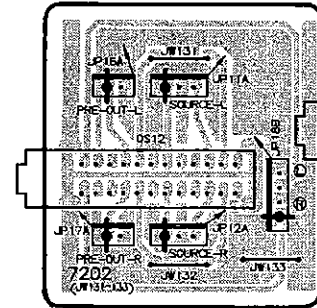

● F-7203 HEAD-PHONE TERMINAL BOARD / ヘッド・ホン端子基板

(COMPONENT SIDE VIEW)

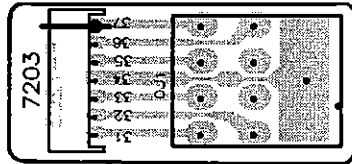

● F-7204 DIRECT INDICATE BOARD / 表示基板

(COMPONENT SIDE VIEW)

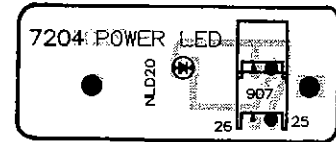

● F-7205 POWER / PROTECTION INDICATE BOARD / 電源・保護表示基板

(COMPONENT SIDE VIEW)

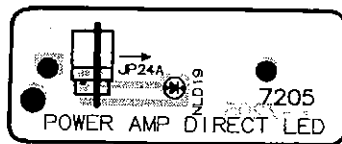

● F-7206 INPUT TERMINALS BOARD / 入力端子基板

(for AU-707MR/MRX & AU-607MR/MRX)

(COMPONENT SIDE VIEW)

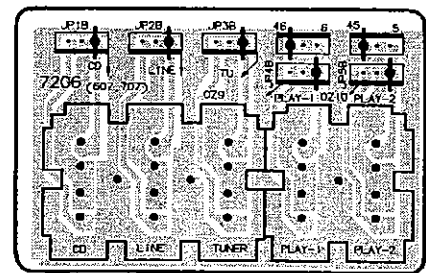

● F-7207 INPUT TERMINALS BOARD / 入力端子基板

(for AU-707MR/MRX & AU-607MR/MRX)

(COMPONENT SIDE VIEW)

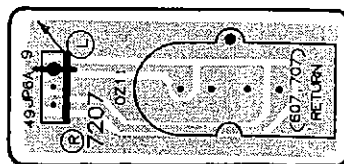

● F-7208 INPUT TERMINALS BOARD / 入力端子基板

(for AU-907MR/MRX)

(COMPONENT SIDE VIEW)

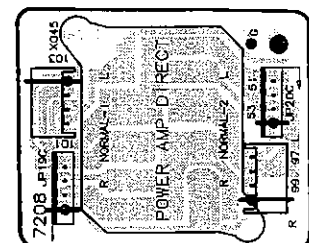

6. PARTS LIST OF BOARD / プリント基板部品表

Notice for Parts/ 部品供給上の注意

- Some printed circuit board are not supplied assembled.
To separate these in this Service Manual, the stock numbers are not indicated for these boards. However, stock numbers for individual parts are indicated.
- Since some capacitors and resistors are omitted from parts lists in service manual, refer to the Common Parts List for capacitors and resistors, which was issued on June 1987.
- Abbreviations in this Parts List are as follows.
 - プリント基板の中には、アッセンブリ供給できないものがあります。
基板番号の後にストック番号の付いていないものは、アッセンブリ供給できませんのでご注意ください。
ただし、基板上の個々の部品については供給いたします。
 - 部品表に記載されていない、抵抗・コンデンサーがあります。それらについては、1987年3月発行の新規標準抵抗・コンデンサーパーツリストを参照してください。
 - このマニュアルには、略語が使用されており、それらについては、略語表を参照してください。

Abbreviations List

C.R. : Carbon Resistor	E.B.L. : Low Leak Bi-Polar Electrolytic Capacitor
S.R. : Solid Resistor	Ta.C. : Tantalum Capacitor
Ce.R. : Cement Resistor	F.C. : Film Capacitor
M.R. : Metal Film Resistor	M.P. : Metalized Paper Capacitor
F.R. : Fusing Resistor	M.M.C. : Metalized Mylar Capacitor
N.I.R. : Non-Inflammable Resistor	P.C. : Polystyrene Capacitor
A.R. : Array Resistor	P.P. : Polypropylene Capacitor
C.C. : Ceramic Capacitor	A.C. : Array Capacitor
C.T. : Ceramic Capacitor, Temperature Compensation	V.R. : Variable Resistor
E.C. : Electrolytic Capacitor	S.V.R. : Semi Variable Resistor
E.L. : Low Leak Electrolytic Capacitor	SW. : Switch
E.B. : Bi-Polar Electrolytic Capacitor	Chip.R. : Chip Resistor
	Chip.C. : Chip Capacitor

AU-907MR/MRX

F-5639R SPEAKER PROTECTION BOARD / スピーカー保護回路基板

<Stock No. 01417800>

Parts No.	Stock No.	Description
△kR100	49224000	N.I.R. 2W 10Ω
△kR101	49224000	N.I.R. 2W 10Ω
△kR102	49217500	N.I.R. 1W 100Ω
△kR103	49217500	N.I.R. 1W 100Ω
kC100	49333600	P.P. 100V 0.033μF NH
kC101	49333600	P.P. 100V 0.033μF NH
KT1	49960800	OUTPUT TRANSFORMER 0060
• TRANSISTOR		
IQ1	46188701	2SC1815
IQ2	46188701	2SC1815
• IC		
IIC1	46207600	TA7317P
• DIODE		
ID1	03117600	1S2473
	or 46086000	1S1588
ID2	03117600	1S2473
	or 46086000	1S1588
ID3	03117600	1S2473
	or 46086000	1S1588
ID4	03117600	1S2473
	or 46086000	1S1588
△ID5	03117700	10E-2

Parts No.	Stock No.	Description
ID6	03117600	1S2473
	or 46086000	1S1588
ID7	48123600	11E2
ID9	03117600	1S2473
	or 46086000	1S1588
IR1	46575900	C.R. 1/2W 180kΩ RMA
IR2	46575900	C.R. 1/2W 180kΩ RMA
△IR17	49866400	N.I.R. 1W 820Ω
△IR18	49853800	N.I.R. 1/2W 2.7kΩ
IC1	49251800	E.B. 10V 100μF NS1
IC2	49251800	E.B. 10V 100μF NS1
IC4	48103400	E.B. 50V 1μF
IC37	49638800	M.M.C. 50V 1μF GS
IC38	49638800	M.M.C. 50V 1μF GS
IRL1	46446400	RELAY AR39093
IRL3	48057001	RELAY FBR46D024
• TRANSISTOR		
△mQ1	03083901	2SD313HP
	or 48509401	2SD1761
mQ2	46581701	2SC1845
• DIODE		
△mD1	03117700	10E-2
△mD2	03117700	10E-2
△mR1	49851500	N.I.R. 1/2W 33Ω
△mR2	49853300	N.I.R. 1/2W 1kΩ
△nR1	49866300	N.I.R. 1W 680Ω

907MR

F-5640R HEAD-PHONE TERMINAL BOARD
/ ヘッド・ホン端子基板

<Stock No. 01417900>

Parts No.	Stock No.	Description
oJ1	49479900	JACK HLJ2307

F-5665I POWER SUPPLY BOARD / 電源基板

<Stock No. 01418000> (Japan Model)

<Stock No. 01418001> (Export Model)

Parts No.	Stock No.	Description
-----------	-----------	-------------

• TRANSISTOR

mQ3	03067401	2SC1845
mQ4	03010901	2SA992
△mQ7	49923000	2SC4793
△mQ8	49922900	2SA1837

• FET

mFT1	46421101	2SK246-GR
mFT2	46421101	2SK246-GR

• DIODE

△mD3	07193300	UB-152
△mD4	07193300	UB-152
△mD5	48795800	F10P20F
△mD6	48795800	F10P20F
△mD7	48795900	F10P20FR
△mD8	48795900	F10P20FR

• ZENER DIODE

mDZ1	49516000	MTZJ24B
mDZ2	49517300	MTZJ33C
	or 49517400	MTZJ33D
mDZ3	49517300	MTZJ33C
	or 49517400	MTZJ33D

△mR3	49205400	N.I.R. 1/2W 4.7Ω	RS-FN
△mR4	49205400	N.I.R. 1/2W 4.7Ω	RS-FN
△mR15	49930600	C.R. 1W 6.8kΩ	RMG
△mR16	49930600	C.R. 1W 6.8kΩ	RMG
△mC11	48527800	M.M.C. 630V 0.01μF	SH
△mC17	48527800	M.M.C. 630V 0.01μF	SH
△mC18	48527800	M.M.C. 630V 0.01μF	SH
mC21	49480400	E.C. 50V 220μF	ARS
mC22	49480400	E.C. 50V 220μF	ARS
mC23	46420400	P.C. 125V 0.01μF	
mC24	46420400	P.C. 125V 0.01μF	
mC25	49480400	E.C. 50V 220μF	ARS
mC26	49480400	E.C. 50V 220μF	ARS
△pF1	46505200	FUSE 125V 12A	(00)
	49628200	FUSE 250V 6A	(XX-C)
	49965100	FUSE 250V 12A	(XX-T)

907MRX

F-7028C PHONO EQUALIZATION AMPLIFIER BOARD
/ イコライザー基板

<Stock No. 01418200>

Parts No.	Stock No.	Description
-----------	-----------	-------------

• TRANSISTOR

iQ1	46581701	2SC1845
iQ2	46581701	2SC1845
iQ3	46728301	2SC2705
iQ4	46728201	2SA1145

• FET

iFT1	46723601	2SK389-BL
	or 46723602	2SK389-V
iFT2	46643701	2SK246-GR
iFT3	46643701	2SK246-GR

• IC

iIC1	46579100	M5219L	OP.-AMP.	(RIAA)
------	----------	--------	----------	--------

• ZENER DIODE

iDZ1	49515500	MTZJ22A
	or 49680700	MTZJ20D
iDZ2	49515500	MTZJ22A
	or 49680700	MTZJ20D

iC5	49454600	E.C. 25V 1000μF	ASF
iC6	49454600	E.C. 25V 1000μF	ASF
iC7	00414500	M.M.C. 100V 0.056μF	
iC8	00413200	M.M.C. 100V 0.016μF	
iC9	49936900	E.C. 50V 47μF	ARD
iC10	49936900	E.C. 50V 47μF	ARD
iC12	49937000	E.C. 50V 100μF	ARD
iC13	49937000	E.C. 50V 100μF	ARD
iC14	49937000	E.C. 50V 100μF	ARD
iC15	49937000	E.C. 50V 100μF	ARD
iC16	49937000	E.C. 50V 100μF	ARD

oS3	49824300	PUSH SW.	PSC 2S2N
oS11	07200200	SLIDE SW.	SSSR24
oZ3	49927700	TERMINAL BOARD	6P T6726
oZ5	49456500	TERMINAL BOARD	4P T6200
oZ6	48792100	TERMINAL BOARD	2P T6199

F-7029C AUDIO TERMINALS BOARD
/ 入出力端子基板

<Stock No. 01418300>

Parts No.	Stock No.	Description
-----------	-----------	-------------

oZ8	49456400	TERMINAL BOARD	4P T6158
-----	----------	----------------	----------

907MRX

907MR

F-7187A MAIN AMPLIFIER BOARD
/ 主增幅回路基板

<Stock No. 01418400>

Parts No.	Stock No.	Description
TRANSISTOR		
kQ1	46581701	2SC1845
kQ2	46581701	2SC1845
kQ3	46581701	2SC1845
kQ4	46581601	2SA992
kQ5	46581601	2SA992
kQ6	46728201	2SA1145
kQ7	46728201	2SA1145
kQ8	46728301	2SC2705
kQ9	46728301	2SC2705
kQ10	03067401	2SC1845
kQ11	03067401	2SC1845
kQ12	46728301	2SC2705
kQ13	46728301	2SC2705
kQ14	46728201	2SA1145
kQ15	46728201	2SA1145
kQ16	49923000	2SC4793
kQ17	49923000	2SC4793
kQ18	49922900	2SA1837
kQ19	49922900	2SA1837
ΔkQ20	49437201	LAPT 2N LF108
ΔkQ21	49437201	LAPT 2N LF108
ΔkQ22	49437301	LAPT 2P LF108
ΔkQ23	49437301	LAPT 2P LF108
ΔkQ24	49437201	LAPT 2N LF108
ΔkQ25	49437301	LAPT 2P LF108
ΔkQ26	49437201	LAPT 2N LF108
ΔkQ27	49437301	LAPT 2P LF108
kQ28	46581601	2SA992
kQ29	49543101	2SC3381
kQ30	48577701	2SA1349
FET		
kFT1	46723601	2SK389-BL
kFT2	46723601	2SK389-BL
kFT3	46643702	2SK246-BL
DIODE		
kD1	48731500	VARISTOR DIODE SV-03YS
kD2	48731500	VARISTOR DIODE SV-03YS
kD3	49732300	DS446
kD4	49732300	DS446
kD5	49732300	DS446
kD6	49732300	DS446
kR1	49501400	C.R. 1/2W 4.7kΩ RMG
kR2	49501400	C.R. 1/2W 4.7kΩ RMG
kR3	49503300	C.R. 1/2W 180kΩ RMG
kR4	49503300	C.R. 1/2W 180kΩ RMG

Parts No.	Stock No.	Description
kR6	49501300	C.R. 1/2W 3.9kΩ RMG
kR7	49501300	C.R. 1/2W 3.9kΩ RMG
kR8	46568100	C.R. 1/2W 100Ω RMA
kR37	46567500	C.R. 1/2W 56Ω RMA
kR38	46567500	C.R. 1/2W 56Ω RMA
ΔkR39	49479200	F.R. 1/2W 100Ω RFA
ΔkR40	49479200	F.R. 1/2W 100Ω RFA
ΔkR41	49479200	F.R. 1/2W 100Ω RFA
ΔkR42	49479200	F.R. 1/2W 100Ω RFA
ΔkR43	49625500	F.R. 1/2W 560Ω RFA
ΔkR44	49625500	F.R. 1/2W 560Ω RFA
ΔkR45	49625400	F.R. 1/2W 120Ω RFA
ΔkR46	49625400	F.R. 1/2W 120Ω RFA
ΔkR47	49479100	F.R. 1/2W 4.7Ω RFA
ΔkR48	49479100	F.R. 1/2W 4.7Ω RFA
ΔkR49	49479100	F.R. 1/2W 4.7Ω RFA
ΔkR50	49479100	F.R. 1/2W 4.7Ω RFA
ΔkR51	49479100	F.R. 1/2W 4.7Ω RFA
ΔkR52	49479100	F.R. 1/2W 4.7Ω RFA
ΔkR53	49479100	F.R. 1/2W 4.7Ω RFA
ΔkR54	49479100	F.R. 1/2W 4.7Ω RFA
ΔkR55	49284100	Ce.R. 5W 0.22Ω
ΔkR56	49284100	Ce.R. 5W 0.22Ω
ΔkR57	49284100	Ce.R. 5W 0.22Ω
ΔkR58	49284100	Ce.R. 5W 0.22Ω
ΔkR59	49284100	Ce.R. 5W 0.22Ω
ΔkR60	49284100	Ce.R. 5W 0.22Ω
ΔkR61	49284100	Ce.R. 5W 0.22Ω
ΔkR62	49284100	Ce.R. 5W 0.22Ω
ΔkR63	49505600	F.R. 1/2W 33Ω RFA
ΔkR64	49505600	F.R. 1/2W 33Ω RFA
ΔkR65	49934000	C.R. 2W 100Ω RS-FN
ΔkR66	49934000	C.R. 2W 100Ω RS-FN
kC1	49457000	E.C. 50V 470μF ARS
kC2	49457000	E.C. 50V 470μF ARS
kC3	49638700	M.M.C. 63V 0.47μF GS
kC4	49638700	M.M.C. 63V 0.47μF GS
kC5	48173400	P.C. 400V 4pF
kC6	48173400	P.C. 400V 4pF
kC9	48061400	P.C. 125V 1500pF
kC10	49839300	M.M.C. 0.47μF SAG
kC11	49839300	M.M.C. 0.47μF SAG
kC12	49523000	E.C. 50V 2.2μF ARSA
kC13	49523000	E.C. 50V 2.2μF ARSA
kC14	49523000	E.C. 50V 2.2μF ARSA
kC15	49523000	E.C. 50V 2.2μF ARSA
kC16	49926700	E.C. 50V 10μF ARGA
kC17	49926700	E.C. 50V 10μF ARGA
kC18	49926700	E.C. 50V 10μF ARGA
kC19	49926700	E.C. 50V 10μF ARGA
kC20	49839300	M.M.C. 0.47μF SAG
kC21	49839300	M.M.C. 0.47μF SAG
kC22	48174700	P.C. 400V 39pF

F-7187A

Parts No.	Stock No.	Description
kC23	48174700	P.C. 400V 39pF
kC24	48174700	P.C. 400V 39pF
kC25	48174700	P.C. 400V 39pF
kC26	49457100	E.C. 50V 15μF ARSA
kC27	49457100	E.C. 50V 15μF ARSA
kC28	49457100	E.C. 50V 15μF ARSA
kC29	49457100	E.C. 50V 15μF ARSA
kC30	49816200	M.M.C. 63V 0.47μF GSG
kC31	49816200	M.M.C. 63V 0.47μF GSG
kC32	49638700	M.M.C. 63V 0.47μF GS
kC33	49967600	M.M.C. 250V 0.047μF WAG
kC34	49967600	M.M.C. 250V 0.047μF WAG
kC35	49638700	M.M.C. 63V 0.47μF GS
kL1	49250200	COIL INDUCTOR 0.47μF U4L
kL2	49250200	COIL INDUCTOR 0.47μF U4L
kVR1	10335700	S.V.R. 100Ω(B)
kVR2	10336300	S.V.R. 1Ω(B)
kVR3	10336300	S.V.R. 1Ω(B)
kVR4	10336100	S.V.R. 470Ω(B)

• **TRANSISTOR**

IQ34	46367101	2SC2603
IQ35	46367001	2SA1115

• **DIODE**

ID30	03117600	1S2473
	or 46086000	1S1588
IC32	49333200	P.P. 100V 0.022μF NH
IC33	49480200	E.C. 50V 47μF ARS
IC34	49480200	E.C. 50V 47μF ARS
IC35	49329200	P.P. 100V 470pF NH

F-7196C PRE AMPLIFIER BOARD

/ 前置增幅回路基板

<Stock No. 01418600>

Parts No.	Stock No.	Description
• TRANSISTOR		
jQ1	49543101	2SC3381
jQ2	49543101	2SC3381
jQ3	48577701	2SA1349
jQ4	46728301	2SC2705
jQ5	46728201	2SA1145
jQ7	46581701	2SC1845
• FET		
jFT1	46723601	2SK389-BL
	or 46723602	2SK389-V
jFT2	46643702	2SK246-BL
ΔjR23	49209000	N.I.R. 1/2W 150Ω RS-FN

Parts No.	Stock No.	Description
ΔjR24	49209000	N.I.R. 1/2W 150Ω RS-FN
ΔjR51	49208600	N.I.R. 1/2W 100Ω RS-FN
ΔjR52	49208600	N.I.R. 1/2W 100Ω RS-FN
jC1	49945700	M.M.C. 63V 0.39μF
jC4	49253300	P.P. 100V 39pF NH
jC5	49642400	P.P. 100V 22pF NH
jC7	49329200	P.P. 100V 470pF
jC14	49945600	M.M.C. 63V 0.33μF
jC15	49451800	E.C. 25V 220μF ASF
jC20	49250700	P.P. 100V 0.047μF NH
jC21	49376400	M.M.C. 63V 0.47μF SA
jC22	49376400	M.M.C. 63V 0.47μF SA
jC25	49480400	E.C. 50V 220μF ARS
jC26	49480400	E.C. 50V 220μF ARS
jVR1	49927500	V.R. 250kΩ (MN)
jVR3	49927600	V.R. 100kΩ (C)
jVR4	49927600	V.R. 100kΩ (C)
jVR5	49392200	S.V.R. 100Ω (B)
• ZENER DIODE		
nDZ1	46823200	RD3.0E-B1
	or 46823300	RD3.0E-B2
nDZ2	46823200	RD3.0E-B1
	or 46823300	RD3.0E-B2
nDZ3	46825000	RD5.6E-B2
	or 46825100	RD5.6E-B3
nLD1	48904700	L.E.D. SEL3810A
nLD2	48904700	L.E.D. SEL3810A
nLD3	48904700	L.E.D. SEL3810A
nLD4	48904700	L.E.D. SEL3810A
nLD5	48904700	L.E.D. SEL3810A
nLD8	48904700	L.E.D. SEL3810A
nLD9	48904700	L.E.D. SEL3810A
nLD10	48904700	L.E.D. SEL3810A
nLD11	48904700	L.E.D. SEL3810A
nLD12	49639100	L.E.D. SEL3110S
nLD13	48904700	L.E.D. SEL3810A
nLD14	49639100	L.E.D. SEL3110S
nLD15	49639100	L.E.D. SEL3110S
oS1	49928100	PUSH SW. SPEC1C NS
oS2	49928200	PUSH SW. SPEC1C SH
oS3	49928200	PUSH SW. SPEC1C SH
oS4	49928200	PUSH SW. SPEC1C SH
oS5	49928200	PUSH SW. SPEC1C SH

907MRX**F-7197C MASTER VOLUME BOARD**
/ 音量調節器基板

<Stock No. 01418700>

Parts No.	Stock No.	Description
jVR2	78006600	V.R. 100kΩ, 10kΩ 27DT6

F-7199C P.-AMP. DIRECT SELECT BOARD
/ パワー・アンプ・ダイレクト切換基板

<Stock No. 01418800>

Parts No.	Stock No.	Description
jR41	49500300	C.R. 1/2W 560Ω RMG
oS14	49386400	ROTARY SW. SRRZ-S6

F-7200C INPUT SELECT BOARD
/ 入力切換基板

<Stock No. 01418900>

Parts No.	Stock No.	Description
oS10	49386400	ROTARY SW. SRRZ-S6

F-7201C TAPE MONITOR SELECT BOARD
/ テープ系入力切換基板

<Stock No. 01419000>

Parts No.	Stock No.	Description
oS11	49927400	ROTARY SW. SRRZ-S4

F-7202C SOURCE P.-AMP. DIRECT SELECT BOARD
/ ソース・パワー・ダイレクト切換基板

<Stock No. 01419100>

Parts No.	Stock No.	Description
oS12	49359400	ROTARY SW. SRRZ-S4

F-7204C DIRECT INDICATE BOARD
/ 表示基板

<Stock No. 01419200>

Parts No.	Stock No.	Description
nLD20	49639100	L.E.D. SEL3110S

907MR**F-7205C POWER/PROTECTION INDICATE BOARD**
/ 電源・保護表示基板

<Stock No. 01419300>

Parts No.	Stock No.	Description
nLD19	49639100	L.E.D. SEL3110S

FA7208C INPUT TERMINALS BOARD
/ 入力端子基板

<Stock No. 01419400>

Parts No.	Stock No.	Description
oZ10	22006300	TERMINAL BOARD 4P KC21-5005

FIXED PARTS

Parts No.	Stock No.	Description
aZ25	48057900	BUS BAR
mC12	49840300	E.C. 85WV 5600μF (00)
	49973500	E.C. 85WV 8200μF (XX)
mC13	49625700	E.C. 85WV 3900μF
mC14	49816100	M.M.C. 50V 1μF GSG
mC15	49625600	E.C. 50WV 4700μF
mC16	49625600	E.C. 50WV 4700μF
mC20	49816100	M.M.C. 50V 1μF GSG
mC27	49638700	M.M.C. 63V 0.47μF GS
mC28	49638700	M.M.C. 63V 0.47μF GS
mC30	46420400	P.C. 125V 0.01μF
ΔmT1	15039300	POWER TRANSFORMER A3130 00 (00)
	15039304	POWER TRANSFORMER A3130XX 230V (XX-C)
	15039307	POWER TRANSFORMER A3130XX 110V (XX-T)
oS17	49967400	ROTARY SW. RSBU06 FLEX.WIRE
oZ14	49541600	CONNECTOR NC3FPBAG1
oZ11	49546300	SP. TERMINAL 2P WBT-0735 WHITE
oZ12	49546400	SP. TERMINAL 2P WBT-0735 RED
oZ2	48587600	GROUND TERMINAL KD41-0055
ΔpC1	49236800	C.C. 250V 10000pF
ΔpS1	49372000	PUSH SW. SDDF-3
ΔpZ1	46730400	A.C. OUTLET 733T-154 NP
ΔpZ2	49254800	A.C. POWER SUPPLY CORD (00)
	46611300	A.C. POWER SUPPLY CORD (XX)

● Layout of Capacitors 907MR & 907MRX

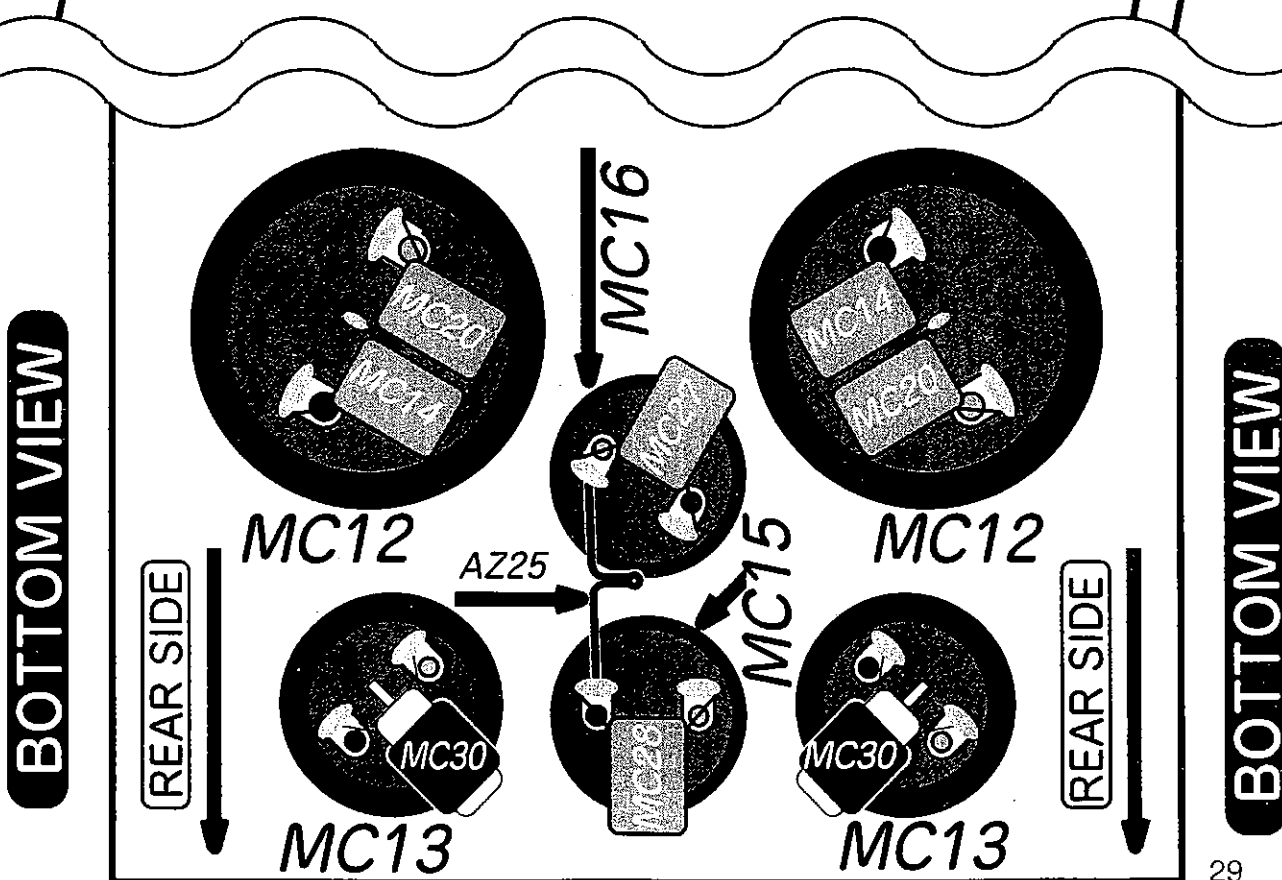
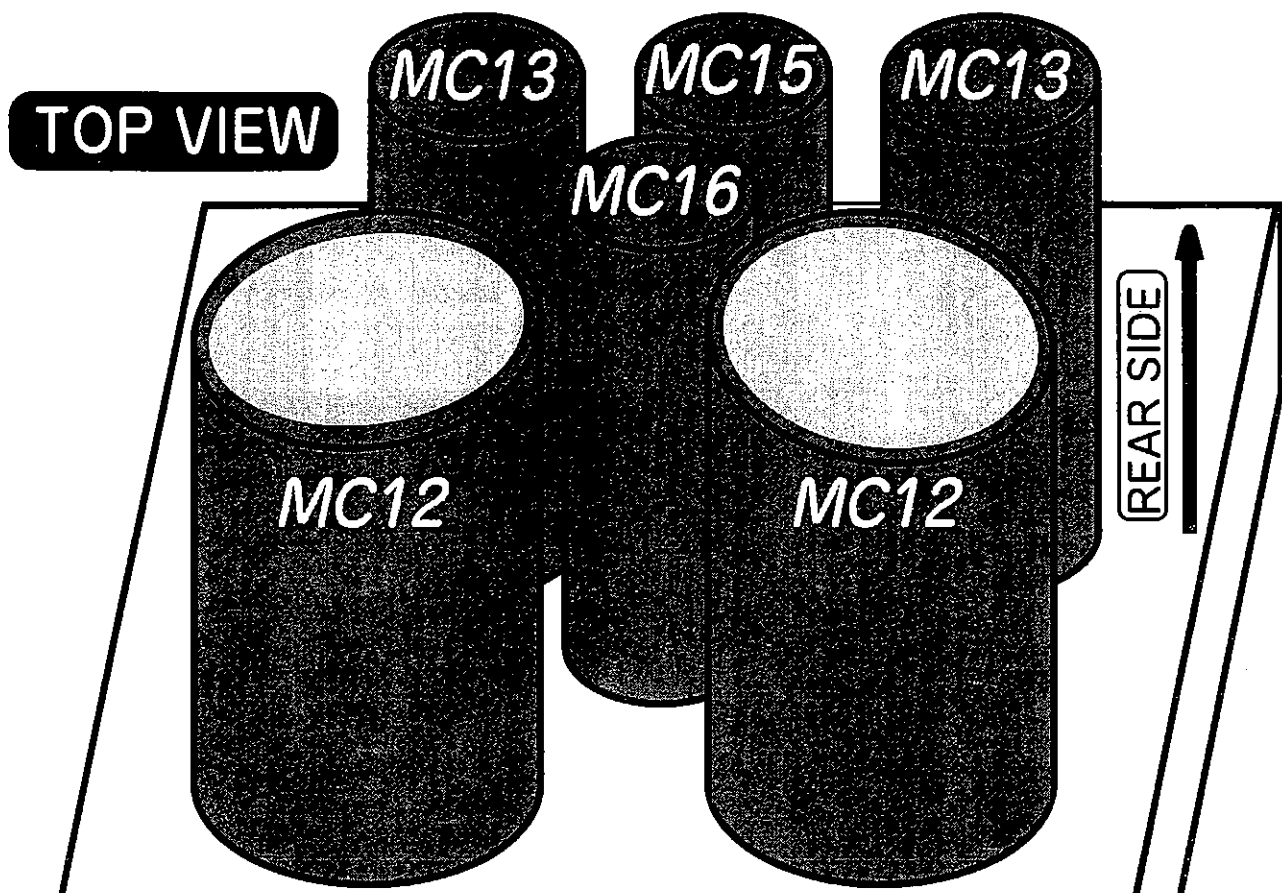

707MRX

707MR

AU-707MR/MRX

F-6198F SPEAKER PROTECTION BOARD
/ スピーカー保護回路基板

<Stock No. 01415700>

Parts No.	Stock No.	Description
ΔkR74	49224000	N.I.R. 2W 10Ω
ΔkR75	49224000	N.I.R. 2W 10Ω
ΔkR82	49864700	N.I.R. 1W 33Ω
ΔkR83	49864700	N.I.R. 1W 33Ω
kC20	49250700	P.P. 100V 0.047μF NH
kC21	49250700	P.P. 100V 0.047μF NH
kT1	49960800	OUTPUT TRANSFORMER 0060

• TRANSISTOR

IQ1	46188701	2SC1815
	or 46367301	2SC2458
IQ2	46188701	2SC1815
	or 46367301	2SC2458

• IC

IIC1	46207600	TA7317P
------	----------	---------

• DIODE

ID1	03117600	1S2473
	or 46086000	1S1588
ID2	03117600	1S2473
	or 46086000	1S1588
ID3	03117600	1S2473
	or 46086000	1S1588
ID4	03117600	1S2473
	or 46086000	1S1588
ΔID5	03117700	10E-2
ID6	03117600	1S2473
	or 46086000	1S1588
ID7	48123600	11E2
ID8	48123600	11E2
ID10	03117600	1S2473
	or 46086000	1S1588

IR1	46575700	C.R. 1/2W 150kΩ	RMA
IR2	46575700	C.R. 1/2W 150kΩ	RMA
ΔIR14	49853100	N.I.R. 1/2W 680Ω	
ΔIR17	49853100	N.I.R. 1/2W 680Ω	
ΔIR18	49853800	N.I.R. 1/2W 2.7kΩ	
IC1	49251800	E.B. 10V 100μF	NS-1
IC2	49251800	E.B. 10V 100μF	NS-1
IC4	48103400	E.B. 50V 1μF	
IRL1	46446400	RELAY	AR39093
IRL2	46446400	RELAY	AR39093
IRL3	48057001	RELAY	FBR46D024

Parts No. Stock No. Description

• TRANSISTOR

ΔmQ5	03083902	2SD313HP
	or 48509401	2SD1761

• ZENER DIODE

mDZ3	46830000	RD24E-B4
	or 46830100	RD27E-B1

ΔmR6	49878700	N.I.R. 2W 68Ω
------	----------	---------------

oZ1	48592700	SPEAKER TERMINAL 8P	KD31-0346
-----	----------	---------------------	-----------

F-6707I POWER SUPPLY BOARD / 電源基板

<Stock No. 01415800> (Japan Model)

<Stock No. 01415801> (Export Model)

Parts No. Stock No. Description

• TRANSISTOR

ΔmQ1	49923000	2SC4793
ΔmQ2	49922900	2SA1837
mQ3	46581701	2SC1845
mQ4	46581601	2SA992

• FET

mFT1	46643501	2SK163-K2
	or 46643602	2SK117-GR
mFT2	46643501	2SK163-K2
	or 46643602	2SK117-GR

• DIODE

ΔmD4	48667400	FMG-22S
ΔmD5	48667400	FMG-22S
ΔmD6	48667500	FMG-22R
ΔmD7	48667500	FMG-22R
ΔmD8	49923900	11DF2
ΔmD9	49923900	11DF2
ΔmD10	49923900	11DF2
ΔmD11	49923900	11DF2
ΔmD30	03117700	10E-2
ΔmD31	03117700	10E-2

• ZENER DIODE

mDZ1	46831100	RD33E-B3
	or 46831200	RD33E-B4
mDZ2	46831100	RD33E-B3
	or 46831200	RD33E-B4

ΔmR1	49206200	N.I.R. 1/2W 10Ω	
ΔmR2	49206200	N.I.R. 1/2W 10Ω	
ΔmR32	49866300	N.I.R. 1W 680Ω	
ΔmC1	48527800	M.M.C. 630V 0.01μF	SH
ΔmC2	48527800	M.M.C. 630V 0.01μF	SH
mC4	49457000	E.C. 50V 470μF	ARS

707MR**F-6707I**

Parts No. Stock No. Description

mC5	49457000	E.C.	50V	470 μ F	ARS
mC6	49480300	E.C.	50V	100 μ F	ARS
mC7	49480300	E.C.	50V	100 μ F	ARS
mC8	49457000	E.C.	50V	470 μ F	ARS
mC9	49457000	E.C.	50V	470 μ F	ARS
mC30	49638700	M.M.C.	63V	0.47 μ F	GS
mC31	49638700	M.M.C.	63V	0.47 μ F	GS
mC44	49737300	E.C.	50V	10 μ F	ARSA
mC45	49737300	E.C.	50V	10 μ F	ARSA
Δ pF1	46505100	FUSE	125V	10A	(00)
	49628100	FUSE	250V	5A	(XX-C)
	49628500	FUSE	250V	10A	(XX-T)

F-7049D PHONO EQUALIZATION AMPLIFIER BOARD
/ イコライザー基板

<Stock No. 01416000>

Parts No. Stock No. Description

• TRANSISTOR

iQ1 46581701 2SC1845

• FET

iFT1 46723601 2SK389-BL
or 46723602 2SK389-V

• IC

iIC1 46579100 M5219L OP-AMP. (RIAA)

• ZENER DIODE

iDZ1 46825200 RD6.2E-B1

iDZ2 46829100 RD20E-B3

or 46829300 RD22E-B1

iDZ3 46829100 RD20E-B3

or 46829300 RD22E-B1

 Δ iR32 49852800 N.I.R. 1/2W 390 Ω Δ iR33 49852800 N.I.R. 1/2W 390 Ω iC1 49452300 E.C. 50V 1 μ F ASFiC6 49450900 E.C. 10V 47 μ F ASFiC10 49453500 E.C. 10V 1000 μ F ASFiC11 49452900 E.C. 50V 100 μ F ASFiC12 49452900 E.C. 50V 100 μ F ASFiC31 49451700 E.C. 25V 100 μ F ASFiC32 49451800 E.C. 25V 220 μ F ASFiC33 49451800 E.C. 25V 220 μ F ASFiC111 49452300 E.C. 50V 1 μ F ASF

oS15 49824300 PUSH SW. PSC 2S2N

oS16 07200200 SLIDE SW. SSSR24

oZ3 48792100 TERMINAL BOARD 2P T6199

oZ5 49456500 TERMINAL BOARD 4P T6200

oZ6 48792100 TERMINAL BOARD 2P T6199

707MRX**F-7063D INPUT TERMINALS BOARD**

/ 入力端子基板

<Stock No. 01416100>

Parts No. Stock No. Description

oZ12 49708500 TERMINAL BOARD 4P T6390

F-7185B DRIVER STAGE of MAIN AMPLIFIER BOARD

/ 主増幅回路基板

<Stock No. 01416300>

Parts No. Stock No. Description

• TRANSISTOR

kQ1 46581601 2SA992

kQ2 46581701 2SC1845

or 46947401 2SC2459

kQ3 46581701 2SC1845

or 46947401 2SC2459

kQ4 46581601 2SA992

or 46947301 2SA1049

kQ5 46581601 2SA992

or 46947301 2SA1049

kQ6 46728201 2SA1145

kQ7 46728301 2SC2705

kQ8 46728201 2SA1145

kQ9 46728301 2SC2705

kQ10 03067401 2SC1845

kQ11 03067401 2SC1845

kQ24 46581701 2SC1845

kQ25 49543101 2SC3381

kQ26 48577701 2SA1349

• FET

kFT1 46723601 2SK389-BL

or 46723602 2SK389-V

kFT2 46723601 2SK389-BL

or 46723602 2SK389-V

kFT3 46643702 2SK246-BL

• DIODE

kD1 48731500 VARISTOR DIODE SV-03YS

kD2 48731500 VARISTOR DIODE SV-03YS

kR1 49501300 C.R. 1/2W 3.9k Ω RMGkR2 46572500 C.R. 1/2W 6.8k Ω RMAkR3 46572500 C.R. 1/2W 6.8k Ω RMAkR4 46568900 C.R. 1/2W 220k Ω RMAkR29 49503200 C.R. 1/2W 150k Ω RMGkR30 49503200 C.R. 1/2W 150k Ω RMGkR31 49501300 C.R. 1/2W 3.9k Ω RMG Δ kR51 49207400 N.I.R. 1/2W 33 Ω Δ kR52 49207400 N.I.R. 1/2W 33 Ω kR54 46567500 C.R. 1/2W 56 Ω RMA

707MRX**F-7185B**

Parts No.	Stock No.	Description
kR55	46567500	C.R. 1/2W 56Ω RMA
kC1	48061100	P.C. 125V 820pF
kC2	49480200	E.C. 50V 47μF ARS
kC3	49480200	E.C. 50V 47μF ARS
kC5	48173400	P.C. 400V 4pF
kC6	48173400	P.C. 400V 4pF
kC10	49480300	E.C. 50V 100μF ARS
kC11	49480300	E.C. 50V 100μF ARS
kC12	49480300	E.C. 50V 100μF ARS
kC13	49480300	E.C. 50V 100μF ARS
kC27	49480500	E.C. 50V 1000μF ARS
kC28	49480500	E.C. 50V 1000μF ARS
kC31	49376400	M.M.C. 63V 0.47μF SA
kC32	49376400	M.M.C. 63V 0.47μF SA
kC34	49480200	E.C. 50V 47μF ARS
kC35	49480200	E.C. 50V 47μF ARS
kVR1	49392200	S.V.R. 100Ω (B)
kVR2	49392400	S.V.R. 470Ω (B)
kVR3	48078600	S.V.R. 1kΩ (B)
kVR4	48078600	S.V.R. 1kΩ (B)

F-7186B POWER STAGE of MAIN AMPLIFIER BOARD
/ 主增幅回路基板

<Stock No. 01416400>

Parts No.	Stock No.	Description
• TRANSISTOR		
kQ12	46728301	2SC2705
kQ13	46728301	2SC2705
kQ14	46728201	2SA1145
kQ15	46728201	2SA1145
kQ16	49923000	2SC4793
kQ17	49923000	2SC4793
kQ18	49922900	2SA1837
kQ19	49922900	2SA1837
ΔkQ20	49485601	LAPT 3N LF115
ΔkQ21	49485601	LAPT 3N LF115
ΔkQ22	49485701	LAPT 3P LF115
ΔkQ23	49485701	LAPT 3P LF115
• DIODE		
kD3	49732300	DS446
kD4	49732300	DS446
kD5	49732300	DS446
kD6	49732300	DS446
ΔkR60	49208600	N.I.R. 1/2W 100Ω
ΔkR61	49208600	N.I.R. 1/2W 100Ω
ΔkR62	49208600	N.I.R. 1/2W 100Ω
ΔkR63	49208600	N.I.R. 1/2W 100Ω

707MR

Parts No.	Stock No.	Description
ΔkR64	49210400	N.I.R. 1/2W 560W
ΔkR65	49210400	N.I.R. 1/2W 560W
ΔkR66	49208800	N.I.R. 1/2W 120Ω
ΔkR67	49208800	N.I.R. 1/2W 120Ω
ΔkR68	49284300	Ce.R. 5W 0.47Ω
ΔkR69	49284300	Ce.R. 5W 0.47Ω
ΔkR70	49284300	Ce.R. 5W 0.47Ω
ΔkR71	49284300	Ce.R. 5W 0.47Ω
ΔkR72	49224000	N.I.R. 2W 10Ω
ΔkR73	49224000	N.I.R. 2W 10Ω
ΔkR76	49205400	N.I.R. 1/2W 4.7Ω
ΔkR77	49205400	N.I.R. 1/2W 4.7Ω
ΔkR78	49205400	N.I.R. 1/2W 4.7Ω
ΔkR79	49205400	N.I.R. 1/2W 4.7Ω
ΔkR88	49284300	Ce.R. 5W 0.47Ω
ΔkR89	49284300	Ce.R. 5W 0.47Ω
ΔkR90	49284300	Ce.R. 5W 0.47Ω
ΔkR91	49284300	Ce.R. 5W 0.47Ω
kC14	49253300	P.P. 100V 39pF NH
kC15	49253300	P.P. 100V 39pF NH
kC16	49253300	P.P. 100V 39pF NH
kC17	49253300	P.P. 100V 39pF NH
kC18	49967600	M.M.C. 250V 0.047μF WAG
kC19	49967600	M.M.C. 250V 0.047μF WAG
kC33	46222800	M.M.C. 100V 0.47μF GU
KL1	49250100	COIL INDUCTOR 0.8μH U4L
KL2	49250100	COIL INDUCTOR 0.8μH U4L

• TRANSISTOR

IQ3	46367101	2SC2603
IQ4	46367001	2SA1115

• DIODE

ID9	03117600	1S2473
	or 46086000	1S1588

IC12	49333200	P.P. 100V 0.022μF NH
IC13	49452800	E.C. 50V 47μF ASF

F-7196B PRE AMPLIFIER BOARD
/ 前置增幅回路基板

<Stock No. 01416600>

Parts No.	Stock No.	Description
• TRANSISTOR		
jQ1	49543101	2SC3381
jQ2	49543101	2SC3381
jQ3	48577701	2SA1349
jQ4	46728301	2SC2705

707MR

F-7196B

Parts No.	Stock No.	Description
jQ5	46728201	2SA1145
jQ7	46581701	2SC1845
• FET		
jFT1	46723601	2SK389-BL
	or 46723602	2SK389-V
jFT2	46643702	2SK246-BL
ΔjR23	49209000	N.I.R. 1/2W 150Ω
ΔjR24	49209000	N.I.R. 1/2W 150Ω
jR41	49500300	C.R. 1/2W 560Ω RMG
ΔjR51	49208600	N.I.R. 1/2W 100Ω
ΔjR52	49208600	N.I.R. 1/2W 100Ω
jC1	49945700	M.M.C. 63V 0.39μF
jC14	49945600	M.M.C. 63V 0.33μF
jC15	49451800	E.C. 25V 220μF ASF
jC20	46876500	MYLAR CAPACITOR 100V 0.047μF
jC25	49937100	E.C. 50V 220μF ARD
jC26	49937100	E.C. 50V 220μF ARD
jVR1	49927500	V.R. 250K (MN)
jVR3	49927600	V.R. 100kΩ (C)
jVR4	49927600	V.R. 100kΩ (C)
jVR5	49392200	S.V.R. 100Ω (B)
• ZENER DIODE		
nDZ1	46823200	RD3.0E-B1
	or 46823300	RD3.0E-B2
nDZ2	46823200	RD3.0E-B1
	or 46823300	RD3.0E-B2
nDZ3	46825000	RD5.6E-B2
	or 46825100	RD5.6E-B3
nLD1	48904700	L.E.D. SEL3810A
nLD3	48904700	L.E.D. SEL3810A
nLD4	48904700	L.E.D. SEL3810A
nLD5	48904700	L.E.D. SEL3810A
nLD6	48904700	L.E.D. SEL3810A
nLD7	48904700	L.E.D. SEL3810A
nLD8	48904700	L.E.D. SEL3810A
nLD9	48904700	L.E.D. SEL3810A
nLD10	48904700	L.E.D. SEL3810A
nLD11	48904700	L.E.D. SEL3810A
nLD12	49639100	L.E.D. SEL3110S
nLD13	48904700	L.E.D. SEL3810A
nLD14	49639100	L.E.D. SEL3110S
nLD15	49639100	L.E.D. SEL3110S
oS1	49928100	PUSH SW. SPEC1C NS

707MRX

Parts No.	Stock No.	Description
oS3	49928200	PUSH SW. SPEC1C SH
oS4	49928200	PUSH SW. SPEC1C SH
oS5	49928200	PUSH SW. SPEC1C SH
oS6	49928200	PUSH SW. SPEC1C SH
oS7	49928200	PUSH SW. SPEC1C SH

F-7197B MASTER VOLUME BOARD

/ 音量調節器基板

<Stock No. 01416700>

Parts No.	Stock No.	Description
jVR2	78006700	V.R. 100kΩ, 10kΩ 27DT6

F-7199B P.-AMP. DIRECT SELECT BOARD

/ パワー・アンプ・ダイレクト切換基板

<Stock No. 01416800>

Parts No.	Stock No.	Description
oS14	49386400	ROTARY SW. SRRZ-S6

F-7200B INPUT SELECT BOARD

/ 入力切換基板

<Stock No. 01416900>

Parts No.	Stock No.	Description
oS10	49386400	ROTARY SW. SRRZ-S6

F-7201B TAPE MONITOR SELECT BOARD

/ テープ系入力切換基板

<Stock No. 01417000>

Parts No.	Stock No.	Description
oS11	49927400	ROTARY SW. SRRZ-S4

F-7202B SOURCE P.-AMP. DIRECT SELECT BOARD

/ ソース・パワー・ダイレクト切換基板

<Stock No. 01417100>

Parts No.	Stock No.	Description
oS12	49359400	ROTARY SW. SRRZ-S4

707MRX**F-7203B HEAD-PHONE TERMINAL BOARD**
/ ヘッド・ホン端子基板

<Stock No. 01417200>

Parts No.	Stock No.	Description
oJ1	49479900	JACK LHJ2307

F-7204B DIRECT INDICATE BOARD
/ 表示基板

<Stock No. 01417300>

Parts No.	Stock No.	Description
nLD20	49639100	L.E.D. SEL3110S

F-7205B POWER/PROTECTION INDICATE BOARD
/ 電源・保護表示基板

<Stock No. 01417400>

Parts No.	Stock No.	Description
nLD19	49639100	L.E.D. SEL3110S

F-7206B INPUT TERMINALS BOARD
/ 入力端子基板

<Stock No. 01417500>

Parts No.	Stock No.	Description
oZ8	49708600	TERMINAL BOARD 6P T6391
oZ10	49708500	TERMINAL BOARD 4P T6390

F-7207B INPUT TERMINALS BOARD
/ 入力端子基板

<Stock No. 01417600>

Parts No.	Stock No.	Description
oZ11	49359700	TERMINAL BOARD 2P T6389

707MR**FIXED PARTS**

Parts No.	Stock No.	Description
ΔmR3	49975400	N.I.R. 2W 6.8kΩ
ΔmR4	49975400	N.I.R. 2W 6.8kΩ
mC11	49840300	E.C. 85WV 5600μF (00)
	49973500	E.C. 85WV 8200μF (XX)
mC12	49909800	E.C. 80WV 8200μF
mC13	49816200	M.M.C. 63V 0.47μF GSG
mC14	46420400	P.C. 125V 0.01μF
mC15	49816200	M.M.C. 63V 0.47μF
ΔmPT1	15043310	POWER TRANSFORMER A3560 00 (00)
	15039804	POWER TRANSFORMER A3350 XX 230V (XX-C)
	15039807	POWER TRANSFORMER A3350 XX 110V (XX-T)
oS17	49967400	ROTARY SW. SRBU 06 FLEX. WIRE
oZ14	49541600	CONNECTOR NC3FPBAG1
oZ2	48587600	GROUND TERMINAL KD41-0055
ΔpC1	49236800	C.C. 250V 10000pF
ΔpS1	49372000	PUSH SW. SDDF-3
ΔpZ3	46730400	AC OUTLET
ΔpZ4	46541100	POWER SUPPLY CORD (00)
	4632100	POWER SUPPLY CORD (XX)

707MR

707MRX

● Layout of Capacitors 707MR & 707MRX

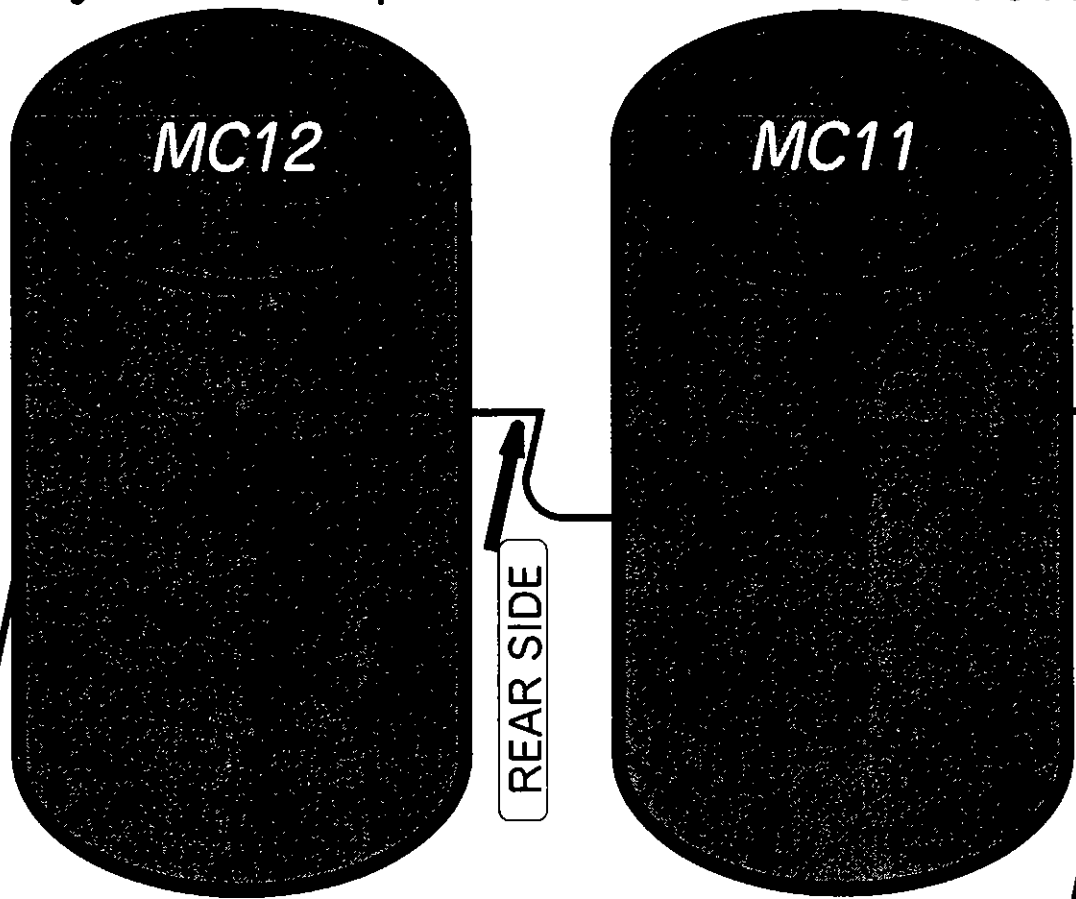

TOP VIEW



BOTTOM VIEW

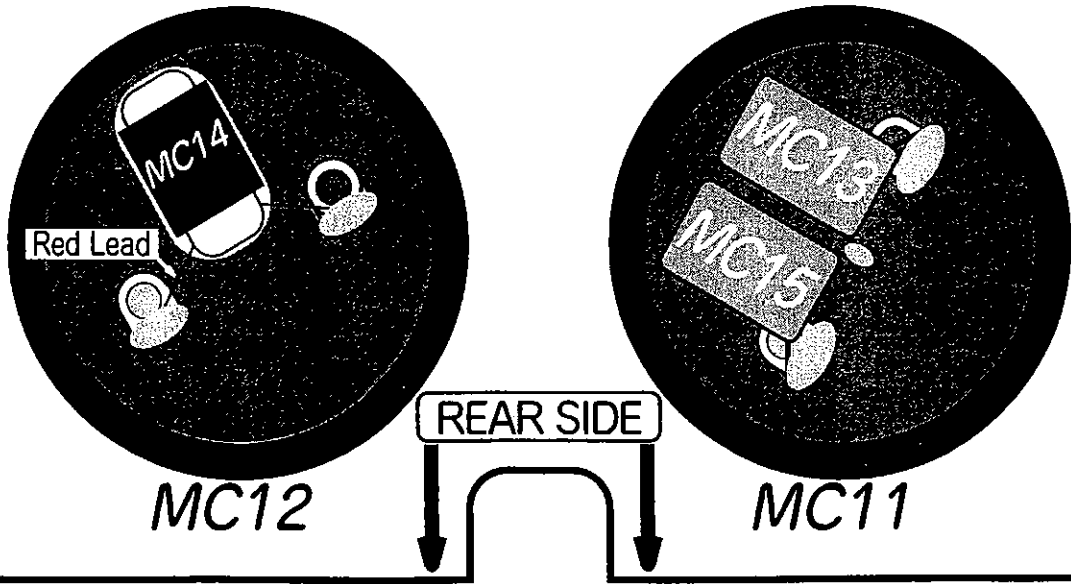

AU-607MRX

F-6161L SPEAKER PROTECTION BOARD

<Stock No. 01419601>

Parts No.	Stock No.	Description
-----------	-----------	-------------

ΔkR74	49877700	N.I.R. 2W 10Ω
ΔkR75	49877700	N.I.R. 2W 10Ω
ΔkR82	49864700	N.I.R. 1W 33Ω
ΔkR83	49864700	N.I.R. 1W 33Ω
kT1	49960800	OUTPUT TRANSFORMER 0060

• TRANSISTOR

IQ1	46188701	2SC1815
	or 46367301	2SC2458
IQ2	46188701	2SC1815
	or 46367301	2SC2458

• IC

LIC1	46207600	TA7317P
------	----------	---------

• DIODE

ID1	03117600	1S2473
	or 46086000	1S1588
ID2	03117600	1S2473
	or 46086000	1S1588
ID3	03117600	1S2473
	or 46086000	1S1588
ID4	03117600	1S2473
	or 46086000	1S1588
ΔID5	03117700	10E2
ID6	03117600	1S2473
	or 46086000	1S1588
ID7	48123600	11E2
ID8	48123600	11E2

ΔIR14	49853100	N.I.R. 1/2W 680Ω
ΔLR17	49853100	N.I.R. 1/2W 680Ω
ΔIR18	49854300	N.I.R. 1/2W 6.8kΩ
IC1	48101900	E.B. 10V 100μF
IC2	48101900	E.B. 10V 100μF
IC4	48103400	E.B. 50V 1μF
IRL1	49358900	RELAY G5R-2232C
IRL2	49358900	RELAY G5R-2232C
oZ1	48592700	SPEAKER TERMINAL 8P KD31-0346

F-6707J POWER SUPPLY BOARD

<Stock No. 01419701>

Parts No.	Stock No.	Description
-----------	-----------	-------------

• TRANSISTOR

ΔmQ1	49923000	2SC4793
------	----------	---------

Parts No.	Stock No.	Description
-----------	-----------	-------------

ΔmQ2	49922900	2SA1837
mQ3	46581701	2SC1845
mQ4	46581601	2SA992
mQ30	03083902	2SD313HP
	or 48509401	2SD1761

• FET

mFT1	46643501	2SK163-K2
	or 46643602	2SK117-GR
mFT2	46643501	2SK163-K2
	or 46643602	2SK117-GR

• DIODE

ΔmD4	48667400	FMG-22S
ΔmD5	48667400	FMG-22S
ΔmD6	48667500	FMG-22R
ΔmD7	48667500	FMG-22R
ΔmD8	07112300	10DF2
ΔmD9	07112300	10DF2
ΔmD10	07112300	10DF2
ΔmD11	07112300	10DF2
ΔmD30	03117700	10E2
ΔmD31	03117700	10E2

• ZENER DIODE

mDZ1	46831100	RD33E-B3
	or 46831200	RD33E-B4
mDZ2	46831100	RD33E-B3
	or 46831200	RD33E-B4
mDZ30	46830000	RD24E-B4
	or 46830100	RD27E-B1

ΔmR1	49850900	N.I.R. 1/2W 10Ω
ΔmR2	49850900	N.I.R. 1/2W 10Ω
ΔmR3	49975400	N.I.R. 2W 6.8kΩ
ΔmR4	49975400	N.I.R. 2W 6.8kΩ
ΔmR30	49878900	N.I.R. 2W 100Ω
ΔmR31	49853500	N.I.R. 1/2W 1.5kΩ
ΔmR32	49866300	N.I.R. 1W 680Ω
ΔmC1	08680400	C.C. 500V 0.01μF
ΔmC2	08680400	C.C. 500V 0.01μF
mC4	49970600	E.C. 50V 470μF GSM
mC5	49970600	E.C. 50V 470μF GSM
mC6	49452900	E.C. 50V 100μF ASF
mC7	49452900	E.C. 50V 100μF ASF
mC8	49970600	E.C. 50V 470μF GSM
mC9	49970600	E.C. 50V 470μF GSM
mC30	49376400	M.M.C. 63V 0.47μF SA
mC31	49376400	M.M.C. 63V 0.47μF SA
mC44	49970600	E.C. 50V 470μF GSM
mC45	49970600	E.C. 50V 470μF GSM
ΔpF1	49628000	FUSE 250V 4A (XX-C)
	or 49628400	FUSE 250V 8A (XX-T)

F-7049E PHONO EQUALIZATION AMPLIFIER BOARD

<Stock No. 01419901>

Parts No.	Stock No.	Description
• TRANSISTOR		
iQ1	46581701	2SC1845
• FET		
iFT1	46723601	2SK389-BL
	or 46723602	2SK389-V
• IC		
iIC1	46579100	M5219L OP.-AMP. (RIAA)
• ZENER DIODE		
iDZ1	46825200	RD6.2E-B1
iDZ2	46829100	RD20E-B3
	or 46829300	RD22E-B1
iDZ3	46829100	RD20E-B3
	or 46829300	RD22E-B1
ΔiR32	49852800	N.I.R. 1/2W 390Ω
ΔiR33	49852800	N.I.R. 1/2W 390Ω
iC1	49452300	E.C. 50V 1μF ASF
iC6	49450900	E.C. 10V 47μF ASF
iC10	49453500	E.C. 10V 1000μF ASF
iC11	49452800	E.C. 50V 47μF ASF
iC12	49452800	E.C. 50V 47μF ASF
iC31	49451700	E.C. 25V 100μF ASF
iC32	49451800	E.C. 25V 220μF ASF
iC33	49451800	E.C. 25V 220μF ASF
iC111	49452300	E.C. 50V 1μF ASF
oS15	49824300	PUSH SW. PSC 2S2N
oS16	07200200	SLIDE SW. SSSR24
oZ3	48791800	TERMINAL BOARD 2P T6199
oZ5	48791900	TERMINAL BOARD 4P T6200
oZ6	48791800	TERMINAL BOARD 2P T6199

F-7063E INPUT TERMINALS BOARD

<Stock No. 01420001>

Parts No.	Stock No.	Description
oZ12	49708500	TERMINAL BOARD 4P T6390

F-7185C DRIVER STAGE of MAIN AMPLIFIER BOARD

<Stock No. 01420201>

Parts No.	Stock No.	Description
• TRANSISTOR		
kQ1	46581601	2SA992

Parts No.	Stock No.	Description
kQ2	46581701	2SC1845
	or 46947401	2SC2459
kQ3	46581701	2SC1845
	or 46947401	2SC2459
kQ4	46581601	2SA992
	or 46947301	2SA1049
kQ5	46581601	2SA992
	or 46947301	2SA1049
kQ6	46728201	2SA1145
kQ7	46728301	2SC2705
kQ8	46728201	2SA1145
kQ9	46728301	2SC2705
kQ10	03067401	2SC1845
kQ11	03067401	2SC1845
kQ24	46581701	2SC1845
kQ25	49543101	2SC3381
kQ26	48577701	2SA1349
• FET		
kFT1	46723601	2SK389-BL
	or 46723602	2SK389-V
kFT2	46723601	2SK389-BL
	or 46723602	2SK389-V
kFT3	46643702	2SK246-BL
• DIODE		
kD1	48731500	VARISTOR DIODE SV-03YS
kD2	48731500	VARISTOR DIODE SV-03YS
ΔkR51	49851500	N.I.R. 1/2W 33Ω
ΔkR52	49851500	N.I.R. 1/2W 33Ω
kC2	49973400	E.C. 50V 47μF GSM
kC3	49973400	E.C. 50V 47μF GSM
kC10	49970300	E.C. 50V 100μF GSM
kC11	49970300	E.C. 50V 100μF GSM
kC12	49970300	E.C. 50V 100μF GSM
kC13	49970300	E.C. 50V 100μF GSM
kC27	49970700	E.C. 50V 1000μF GSM
kC28	49970700	E.C. 50V 1000μF GSM
kVR1	49392200	S.V.R. 100Ω (B)
kVR2	49392400	S.V.R. 470Ω (B)
kVR3	48078600	S.V.R. 1kΩ (B)
kVR4	48078600	S.V.R. 1kΩ (B)

F-7186C POWER STAGE of MAIN AMPLIFIER BOARD

<Stock No. 01420301>

Parts No.	Stock No.	Description
• TRANSISTOR		
kQ12	46728301	2SC2705
kQ13	46728301	2SC2705

F-7186C

Parts No.	Stock No.	Description
kQ14	46728201	2SA1145
kQ15	46728201	2SA1145
kQ16	49923000	2SC4793
kQ17	49923000	2SC4793
kQ18	49922900	2SA1837
kQ19	49922900	2SA1837
ΔkQ20	48729301	2SC3284
ΔkQ21	48729301	2SC3284
ΔkQ22	48729201	2SA1303
ΔkQ23	48729201	2SA1303
• DIODE		
kD3	49732300	DS446
kD4	49732300	DS446
kD5	49732300	DS446
kD6	49732300	DS446
ΔkR60	49852100	N.I.R. 1/2W 100Ω
ΔkR61	49852100	N.I.R. 1/2W 100Ω
ΔkR62	49852100	N.I.R. 1/2W 100Ω
ΔkR63	49852100	N.I.R. 1/2W 100Ω
ΔkR64	49853000	N.I.R. 1/2W 560Ω
ΔkR65	49853000	N.I.R. 1/2W 560Ω
ΔkR66	49852200	N.I.R. 1/2W 120Ω
ΔkR67	49852200	N.I.R. 1/2W 120Ω
ΔkR68	49284100	Ce.R. 5W 0.22Ω
ΔkR69	49284100	Ce.R. 5W 0.22Ω
ΔkR70	49284100	Ce.R. 5W 0.22Ω
ΔkR71	49284100	Ce.R. 5W 0.22Ω
ΔkR72	49877700	N.I.R. 2W 10Ω
ΔkR73	49877700	N.I.R. 2W 10Ω
ΔkR76	49850500	N.I.R. 1/2W 4.7Ω
ΔkR77	49850500	N.I.R. 1/2W 4.7Ω
ΔkR78	49850500	N.I.R. 1/2W 4.7Ω
ΔkR79	49850500	N.I.R. 1/2W 4.7Ω
kC33	49968000	M.M.C. 250V 0.047μF WA
kC34	49973400	E.C. 50V 47μF GSM
kC35	49973400	E.C. 50V 47μF GSM
kL1	46851901	COIL INDUCTOR 0.82μH
kL2	46851901	COIL INDUCTOR 0.82μH
• TRANSISTOR		
IQ3	46367101	2SC2603
IQ4	46367001	2SA1115
• DIODE		
ID9	03117600	1S2473
	or 46086000	1S1588
IC13	49452800	E.C. 50V 47μF ASF

F-7196D PRE AMPLIFIER BOARD

<Stock No. 01420501>

Parts No.	Stock No.	Description
• TRANSISTOR		
jQ1	49543101	2SC3381
jQ2	49543101	2SC3381
jQ3	48577701	2SA1349
jQ4	46581701	2SC1845
jQ5	46581601	2SA992
jQ7	46581701	2SC1845
• FET		
jFT1	46723601	2SK389-BL
	or 46723602	2SK389-V
jFT2	46643702	2SK246-BL
ΔjR23	49852500	N.I.R. 1/2W 220Ω
ΔjR24	49852500	N.I.R. 1/2W 220Ω
ΔjR51	49852100	N.I.R. 1/2W 100Ω
ΔjR52	49852100	N.I.R. 1/2W 100Ω
jC1	49945700	M.M.C. 63V 0.39μF
jC14	49945600	M.M.C. 63V 0.33μF
jC15	49451800	E.C. 25V 220μF ASF
jC20	46876500	MYLAR CAPACITOR 100V 0.047μF
jC25	49970400	E.C. 50V 220μF GSM
jC26	49970400	E.C. 50V 220μF GSM
jVR1	49927500	V.R. 250kΩ (MN)
jVR3	49927600	V.R. 100kΩ (C)
jVR4	49927600	V.R. 100kΩ (C)
jVR5	49392200	S.V.R. 100kΩ (B)
• ZENER DIODE		
nDZ1	46823200	RD3.0E-B1
	or 46823300	RD3.0E-B2
nDZ2	46823200	RD3.0E-B1
	or 46823300	RD3.0E-B2
nDZ3	46823200	RD3.0E-B1
	or 46823300	RD3.0E-B2
nLD1	48904700	L.E.D. SEL3810A
nLD3	48904700	L.E.D. SEL3810A
nLD4	48904700	L.E.D. SEL3810A
nLD5	48904700	L.E.D. SEL3810A
nLD6	48904700	L.E.D. SEL3810A
nLD7	48904700	L.E.D. SEL3810A
nLD8	48904700	L.E.D. SEL3810A
nLD9	48904700	L.E.D. SEL3810A
nLD10	48904700	L.E.D. SEL3810A
nLD11	48904700	L.E.D. SEL3810A
oS1	49928100	PUSH SW. SPEC1C NS
oS3	49928200	PUSH SW. SPEC1C SH
oS4	49928200	PUSH SW. SPEC1C SH
oS5	49928200	PUSH SW. SPEC1C SH
oS6	49928200	PUSH SW. SPEC1C SH
oS7	49928200	PUSH SW. SPEC1C SH

F-7197D MASTER VOLUME BOARD

<Stock No. 01420601>

Parts No.	Stock No.	Description
jVR2	78006700	V.R. 100kΩ, 10kΩ 27DT6

F-7198D P.-AMP. DIRECT SELECT BOARD

<Stock No. 01420701>

Parts No.	Stock No.	Description
oS13	49661900	ROTARY SW. SRRZ-S4

F-7200D INPUT SELECT BOARD

<Stock No. 01420801>

Parts No.	Stock No.	Description
oS10	49386400	ROTARY SW. SRRZ-S6

F-7201A TAPE MONITOR SELECT BOARD

<Stock No. 01414900>

Parts No.	Stock No.	Description
oS11	49927400	ROTARY SW. SRRZ-S4

F-7202D SOURCE P.-AMP. DIRECT SELECT BOARD

<Stock No. 01421001>

Parts No.	Stock No.	Description
oS12	49359400	ROTARY SW. SRRZ-S4

F-7203D HEAD-PHONE TERMINAL BOARD

<Stock No. 01421101>

Parts No.	Stock No.	Description
oJ1	49479900	JACK LHJ2307

F-7204D DIRECT INDICATE BOARD

<Stock No. 01421201>

Parts No.	Stock No.	Description
nLD20	49639100	L.E.D. SEL3110S

F-7205D POWER/PROTECTION INDICATE BOARD

<Stock No. 01421301>

Parts No.	Stock No.	Description
nLD19	49639100	L.E.D. SEL3110S

F-7206D INPUT TERMINALS BOARD

<Stock No. 01421401>

Parts No.	Stock No.	Description
oZ8	49359700	TERMINAL BOARD 2P T6389
oZ9	49359800	TERMINAL BOARD 4P T6390
oZ10	49359800	TERMINAL BOARD 4P T6390

F-7207D INPUT TERMINALS BOARD

<Stock No. 01421501>

Parts No.	Stock No.	Description
oZ11	49928300	TERMINAL BOARD 2P T6389

FIXED PARTS

Parts No.	Stock No.	Description
mC11	49968100	E.C. 63WV 12000μF
mC12	49968100	E.C. 63WV 12000μF
mC13	49376400	M.M.C. 63V 0.47μF SA
mC14	49376400	M.M.C. 63V 0.47μF SA
ΔmPT1	15034804	POWER TRANSFORMER A2810 XX 230V (XX-C)
	or 15034807	POWER TRANSFORMER A2810 XX 110V (XX-T)
oS17	49967400	ROTARY SW. SRBU06 FLEX. WIRE
oZ2	48587600	GROUND TERMINAL KD41-0055
ΔpC1	49236800	C.C. 250V 0.01μF
ΔpS1	48113300	PUSH SW. SDDL8
ΔpZ3	46730400	AC OUTLET
ΔpZ4	46321000	POWER SUPPLY CORD

AU-607MR

F-6161K SPEAKER PROTECTION BOARD
/ スピーカー保護回路基板

<Stock No. 01413600>

Parts No.	Stock No.	Description
ΔkR74	49224000	N.I.R. 2W 10Ω
ΔkR75	49224000	N.I.R. 2W 10Ω
ΔkR82	49864700	N.I.R. 1W 33Ω
ΔkR83	49864700	N.I.R. 1W 33Ω
kC20	49250700	P.P. 100V 0.047μF NH
kC21	49250700	P.P. 100V 0.047μF NH
KT1	49960800	OUTPUT TRANSFORMER 0060

• TRANSISTOR

IQ1	46188701	2SC1815
	or 46367301	2SC2458
IQ2	46188701	2SC1815
	or 46367301	2SC2458

• IC

IIC1	46207600	TA7317P
------	----------	---------

• DIODE

ID1	03117600	1S2473
	or 46086000	1S1588
ID2	03117600	1S2473
	or 46086000	1S1588
ID3	03117600	1S2473
	or 46086000	1S1588
ID4	03117600	1S2473
	or 46086000	1S1588
ΔID5	03117700	10E-2
ID6	03117600	1S2473
	or 46086000	1S1588
ID7	48123600	11E2
ID8	48123600	11E2

ΔIR14	49853100	N.I.R. 1/2W 680Ω
ΔLR17	49853100	N.I.R. 1/2W 680Ω
ΔIR18	49854300	N.I.R. 1/2W 6.8kΩ
IC1	48101900	E.B. 10V 100μF
IC2	48101900	E.B. 10V 100μF
IC4	48103400	E.B. 50V 1μF
IRL1	49358900	RELAY G5R-2232C
IRL2	49358900	RELAY G5R-2232C
oZ1	48592700	SPEAKER TERMINAL 8P KD31-0346

F-6707H POWER SUPPLY BOARD / 電源基板

<Stock No. 01413700>

Parts No. Stock No. Description

• TRANSISTOR

ΔmQ1	49923000	2SC4793
ΔmQ2	49922900	2SA1837
mQ3	46581701	2SC1845
mQ4	46581601	2SA992
mQ30	03083902	2SD313HP
	or 48509401	2SD1761

• FET

mFT1	46643501	2SK163-K2
	or 46643602	2SK117-GR
mFT2	46643501	2SK163-K2
	or 46643602	2SK117-GR

• DIODE

ΔmD4	48667400	FMG-22S
ΔmD5	48667400	FMG-22S
ΔmD6	48667500	FMG-22R
ΔmD7	48667500	FMG-22R
ΔmD8	07112300	10DF2
ΔmD9	07112300	10DF2
ΔmD10	07112300	10DF2
ΔmD11	07112300	10DF2
ΔmD30	03117700	10E-2
ΔmD31	03117700	10E-2

• ZENER DIODE

mDZ1	46831100	RD33E-B3
	or 46831200	RD33E-B4
mDZ2	46831100	RD33E-B3
	or 46831200	RD33E-B4
mDZ30	46830000	RD24E-B4
	or 46830100	RD27E-B1

ΔmR1	49850900	N.I.R. 1/2W 10Ω
ΔmR2	49850900	N.I.R. 1/2W 10Ω
ΔmR30	49878900	N.I.R. 2W 100Ω
ΔmR31	49853500	N.I.R. 1/2W 1.5kΩ
ΔmR32	49866300	N.I.R. 1W 680Ω
ΔmC1	48527800	M.M.C. 630V 0.01μF SH
ΔmC2	48527800	M.M.C. 630V 0.01μF SH
mC4	49457000	E.C. 50V 470μF ARS
mC5	49457000	E.C. 50V 470μF ARS
mC6	49452900	E.C. 50V 100μF ASF
mC7	49452900	E.C. 50V 100μF ASF
mC8	49457000	E.C. 50V 470μF ARS
mC9	49457000	E.C. 50V 470μF ARS
mC30	49376400	M.M.C. 63V 0.47μF SA
mC31	49376400	M.M.C. 63V 0.47μF SA
mC44	49937900	E.C. 50V 10μF ARSAG

607MR**F-6707H**

Parts No. Stock No. Description

mC45	49937900	E.C. 50V 10 μ F	ARSAG
Δ pF1	49628400	FUSE 250V 8A	

F-7049C PHONO EQUALIZATION AMPLIFIER BOARD
/ イコライザー基板

<Stock No. 01413900>

Parts No. Stock No. Description

• TRANSISTOR

iQ1 46581701 2SC1845

• FET

iFT1 46723601 2SK389-BL
or 46723602 2SK389-V

• IC

iIC1 46579100 M5219L OP.-AMP. (RIAA)

• ZENER DIODE

iDZ1 46825200 RD6.2E-B1
iDZ2 46829100 RD20E-B3
or 46829300 RD22E-B1
iDZ3 46829100 RD20E-B3
or 46829300 RD22E-B1

 Δ iR32 49852800 N.I.R. 1/2W 390 Ω Δ iR33 49852800 N.I.R. 1/2W 390 Ω

iC1 49452300 E.C. 50V 1 μ F ASF
iC6 49450900 E.C. 10V 47 μ F ASF
iC10 49453500 E.C. 10V 1000 μ F ASF
iC11 49452800 E.C. 50V 47 μ F ASF
iC12 49452800 E.C. 50V 47 μ F ASF
iC31 49451700 E.C. 25V 100 μ F ASF
iC32 49451800 E.C. 25V 220 μ F ASF
iC33 49451800 E.C. 25V 220 μ F ASF
iC111 49452300 E.C. 50V 1 μ F ASF

oS15 49824300 PUSH SW. PSC 2S2N

oS16 07200200 SLIDE SW. SSSR24

oZ3 48791800 TERMINAL BOARD 2P T6199

oZ5 48791900 TERMINAL BOARD 4P T6200

oZ6 48791800 TERMINAL BOARD 2P T6199

F-7063C INPUT TERMINALS BOARD

/ 入力端子基板

<Stock No. 01414000>

Parts No. Stock No. Description

oZ12 49708500 TERMINAL BOARD 4P T6390

F-7185A DRIVER STAGE of MAIN AMPLIFIER BOARD
/ 主増幅回路基板

<Stock No. 01414200>

Parts No. Stock No. Description

• TRANSISTOR

kQ1 46581601 2SA992
kQ2 46581701 2SC1845
or 46947401 2SC2459
kQ3 46581701 2SC1845
or 46947401 2SC2459
kQ4 46581601 2SA992
or 46947301 2SA1049
kQ5 46581601 2SA992
or 46947301 2SA1049
kQ6 46728201 2SA1145
kQ7 46728301 2SC2705
kQ8 46728201 2SA1145
kQ9 46728301 2SC2705
kQ10 03067401 2SC1845
kQ11 03067401 2SC1845
kQ24 46581701 2SC1845
kQ25 49543101 2SC3381
kQ26 48577701 2SA1349

• FET

kFT1 46723601 2SK389-BL
or 46723602 2SK389-V
kFT2 46723601 2SK389-BL
or 46723602 2SK389-V
kFT3 46643702 2SK246-BL

• DIODE

KD1 48731500 VARISTOR DIODE SV-03YS
KD2 48731500 VARISTOR DIODE SV-03YS
KR1 49501300 C.R. 1/2W 3.9k Ω RMG
KR29 49503100 C.R. 1/2W 120k Ω RMG
KR30 49503100 C.R. 1/2W 120k Ω RMG
KR31 49501300 C.R. 1/2W 3.9k Ω RMG
 Δ kR51 49851500 N.I.R. 1/2W 33 Ω
 Δ kR52 49851500 N.I.R. 1/2W 33 Ω
kC1 49329700 P.P. 100V 750pF NH
kC2 49480200 E.C. 50V 47 μ F ARS
kC3 49480200 E.C. 50V 47 μ F ARS
kC10 49480300 E.C. 50V 100 μ F ARS
kC11 49480300 E.C. 50V 100 μ F ARS
kC12 49480300 E.C. 50V 100 μ F ARS
kC13 49480300 E.C. 50V 100 μ F ARS
kC27 49480500 E.C. 50V 1000 μ F ARS
kC28 49480500 E.C. 50V 1000 μ F ARS
kVR1 49392200 S.V.R. 100 Ω (B)
kVR2 49392400 S.V.R. 470 Ω (B)
kVR3 48078600 S.V.R. 1k Ω (B)
kVR4 48078600 S.V.R. 1k Ω (B)

F-7186A POWER STAGE of MAIN AMPLIFIER BOARD / 主增幅回路基板

<Stock No. 01414300>

Parts No.	Stock No.	Description
-----------	-----------	-------------

• TRANSISTOR

kQ12	46728301	2SC2705
kQ13	46728301	2SC2705
kQ14	46728201	2SA1145
kQ15	46728201	2SA1145
kQ16	49923000	2SC4793
kQ17	49923000	2SC4793
kQ18	49922900	2SA1837
kQ19	49922900	2SA1837
△kQ20	49485401	LAPT 2N LF115
△kQ21	49485401	LAPT 2N LF115
△kQ22	49485501	LAPT 2P LF115
△kQ23	49485501	LAPT 2P LF115

• DIODE

kD3	49732300	DS446
kD4	49732300	DS446
kD5	49732300	DS446
kD6	49732300	DS446

△kR60	49852100	N.I.R.	1/2W	100Ω
△kR61	49852100	N.I.R.	1/2W	100W
△kR62	49852100	N.I.R.	1/2W	100W
△kR63	49852100	N.I.R.	1/2W	100Ω
△kR64	49853000	N.I.R.	1/2W	560Ω
△kR65	49853000	N.I.R.	1/2W	560Ω
△kR66	49852200	N.I.R.	1/2W	120Ω
△kR67	49852200	N.I.R.	1/2W	120Ω
△kR68	49284100	Ce.R.	5W	0.22Ω
△kR69	49284100	Ce.R.	5W	0.22Ω
△kR70	49284100	Ce.R.	5W	0.22Ω
△kR71	49284100	Ce.R.	5W	0.22Ω
△kR72	49224000	N.I.R.	2W	10Ω
△kR73	49224000	N.I.R.	2W	10Ω
△kR76	49205400	N.I.R.	1/2W	4.7Ω
△kR77	49205400	N.I.R.	1/2W	4.7Ω
△kR78	49205400	N.I.R.	1/2W	4.7Ω
△kR79	49205400	N.I.R.	1/2W	4.7Ω
kC14	49253300	P.P.	100V	39pF NH
kC15	49253300	P.P.	100V	39pF NH
kC16	49253300	P.P.	100V	39pF NH
kC17	49253300	P.P.	100V	39pF NH
kC18	49250700	P.P.	100V	0.047μF NH
kC19	49250700	P.P.	100V	0.047μF NH
kC33	49638700	M.M.C.	63V	0.47μF GS
kC34	49480200	E.C.	50V	47μF ARS
kC35	49480200	E.C.	50V	47μF ARS
KL1	49250100	COIL INDUCTOR	0.8μH	U4L
KL2	49250100	COIL INDUCTOR	0.8μH	U4L

Parts No.	Stock No.	Description
-----------	-----------	-------------

• TRANSISTOR

IQ3	46367101	2SC2603
IQ4	46367001	2SA1115

• DIODE

ID9	03117600	1S2473
	or 46086000	1S1588

IC13	49452800	E.C.	50V	47μF	ASF
------	----------	------	-----	------	-----

F-7196A PRE AMPLIFIER BOARD / 前置增幅回路基板

<Stock No. 01414500>

Parts No.	Stock No.	Description
-----------	-----------	-------------

• TRANSISTOR

jQ1	49543101	2SC3381
jQ2	49543101	2SC3381
jQ3	48577701	2SA1349
jQ4	46581701	2SC1845
jQ5	46581601	2SA992
jQ7	46581701	2SC1845

• FET

jFT1	46723601	2SK389-BL
	or 46723602	2SK389-V
jFT2	46643702	2SK246-BL

△jR23	49852500	N.I.R.	1/2W	220Ω
△jR24	49852500	N.I.R.	1/2W	220Ω
△jR51	49852100	N.I.R.	1/2W	100Ω
△jR52	49852100	N.I.R.	1/2W	100Ω
jC1	49945700	M.M.C.	63V	0.39μF
jC14	49945600	M.M.C.	63V	0.33μF
jC15	49451800	E.C.	25V	220μF ASF
jC20	46876500	MYLAR CAPACITOR	100V	0.047μF
jC25	49937100	E.C.	50V	220μF ARD
jC26	49937100	E.C.	50V	220μF ARD
jVR1	49927500	V.R.	250kΩ	(MN)
jVR3	49927600	V.R.	100kΩ	(C)
jVR4	49927600	V.R.	100kΩ	(C)
jVR5	49392200	S.V.R.	100Ω	(B)

• ZENER DIODE

nDZ1	46823200	RD3.0E-B1	
	or 46823300	RD3.0E-B2	
nDZ2	46823200	RD3.0E-B1	
	or 46823300	RD3.0E-B2	
nDZ3	46823200	RD3.0E-B1	
	or 46823300	RD3.0E-B2	
nLD1	48904700	L.E.D.	SEL3810A
nLD3	48904700	L.E.D.	SEL3810A
nLD4	48904700	L.E.D.	SEL3810A
nLD5	48904700	L.E.D.	SEL3810A

607MR**F-7196A**

Parts No.	Stock No.	Description
nLD6	48904700	L.E.D. SEL3810A
nLD7	48904700	L.E.D. SEL3810A
nLD8	48904700	L.E.D. SEL3810A
nLD9	48904700	L.E.D. SEL3810A
nLD10	48904700	L.E.D. SEL3810A
nLD11	48904700	L.E.D. SEL3810A
oS1	49928100	PUSH SW. SPEC1C NS
oS3	49928200	PUSH SW. SPEC1C SH
oS4	49928200	PUSH SW. SPEC1C SH
oS5	49928200	PUSH SW. SPEC1C SH
oS6	49928200	PUSH SW. SPEC1C SH
oS7	49928200	PUSH SW. SPEC1C SH

F-7197A MASTER VOLUME BOARD

/ 音量調節器基板

<Stock No. 01414600>

Parts No.	Stock No.	Description
jR42	49500300	C.R. 1/2W 560Ω RMG
jVR2	78006700	V.R. 100kΩ, 10kΩ 27DT6

F-7198A P.-AMP. DIRECT SELECT BOARD

/ パワー・アンプ・ダイレクト切替基板

<Stock No. 01414700>

Parts No.	Stock No.	Description
oS13	49661900	ROTARY SW. SRRZ-S4

F-7200A INPUT SELECT BOARD / 入力切替基板

<Stock No. 01414800>

Parts No.	Stock No.	Description
oS10	49386400	ROTARY SW. SRRZ-S6

F-7201A TAPE MONITOR SELECT BOARD

/ テープ系入力切替基板

<Stock No. 01414900>

Parts No.	Stock No.	Description
oS11	49927400	ROTARY SW. SRRZ-S4

F-7202A SOURCE P.-AMP. DIRECT SELECT BOARD

/ ソース・パワー・ダイレクト切替基板

<Stock No. 01415000>

Parts No.	Stock No.	Description
oS12	49359400	ROTARY SW. SRRZ-S4

F-7203A HEAD-PHONE TERMINAL BOARD

/ ヘッド・ホン端子基板

<Stock No. 01415100>

Parts No.	Stock No.	Description
oJ1	49479900	JACK LHJ2307

F-7204A DIRECT INDICATE BOARD / 表示基板

<Stock No. 01415200>

Parts No.	Stock No.	Description
nLD20	49639100	L.E.D. SEL3110S

F-7205A POWER/PROTECTION INDICATE BOARD

/ 電源・保護表示基板

<Stock No. 01415300>

Parts No.	Stock No.	Description
nLD19	49639100	L.E.D. SEL3110S

F-7206A INPUT TERMINAL BOARD / 入力端子基板

<Stock No. 01415400>

Parts No.	Stock No.	Description
oZ8	49359700	TERMINAL BOARD 2P T6389
oZ9	49359800	TERMINAL BOARD 4P T6390
oZ10	49359800	TERMINAL BOARD 4P T6390

F-7207A INPUT TERMINAL BOARD / 入力端子基板

<Stock No. 01415500>

Parts No.	Stock No.	Description
oZ11	49928300	TERMINAL BOARD 2P T6389

FIXED PARTS

Parts No.	Stock No.	Description
ΔmR3	49975400	N.I.R. 2W 6.8kΩ
ΔmR4	49975400	N.I.R. 2W 6.8kΩ
mC11	49840200	E.C. 63WV 12000μF
mC12	49840200	E.C. 63WV 12000μF
mC13	49816200	M.M.C. 63V 0.47μF GSG
mC14	49638700	M.M.C. 63V 0.47μF GS
MPT1	15034820	POWER TRANSFORMER A2810 00
oS17	49967400	ROTARY SW. SRBU06 FLEX. WIRE
oZ2	48587600	GROUND TERMINAL KD41-0055
ΔpC1	49236800	C.C. 250V 10000pF
ΔpS1	48113300	PUSH SW. SDDL B
ΔpZ3	46730400	AC OUTLET
ΔpZ4	46541100	POWER SUPPLY CORD

● Layout of Capacitors 607MR & 607MRX

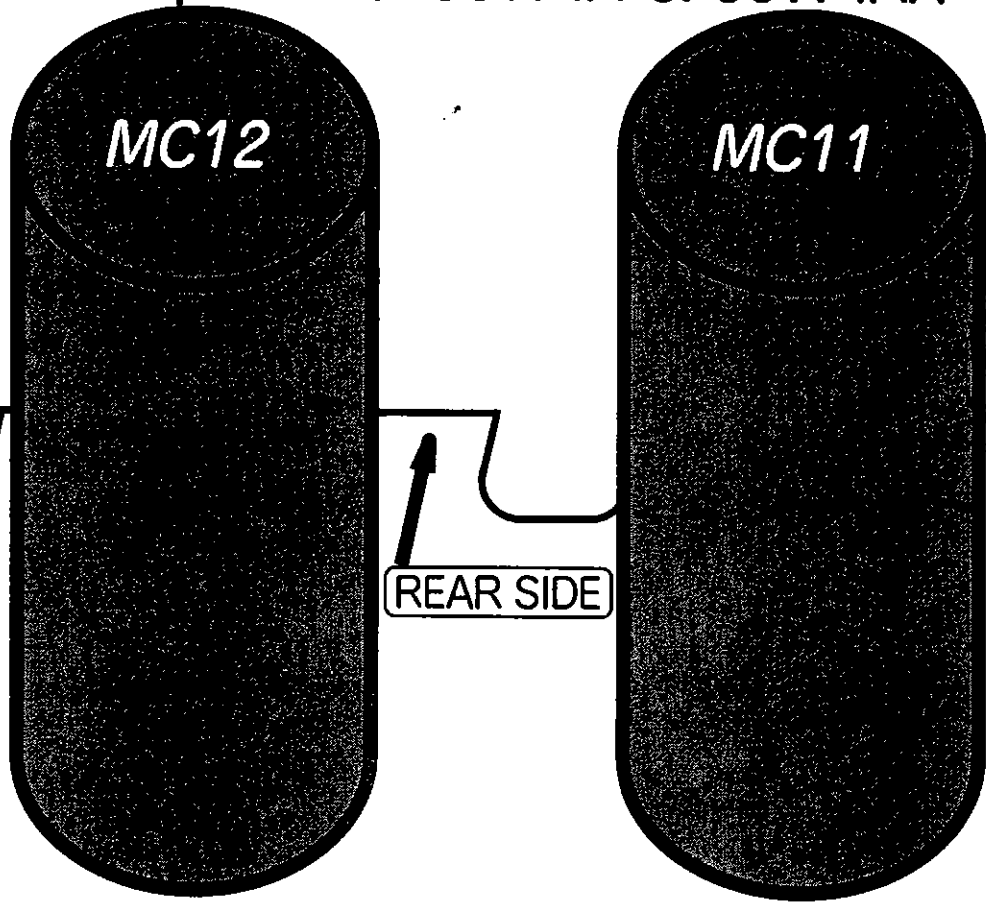

TOP VIEW

BOTTOM VIEW

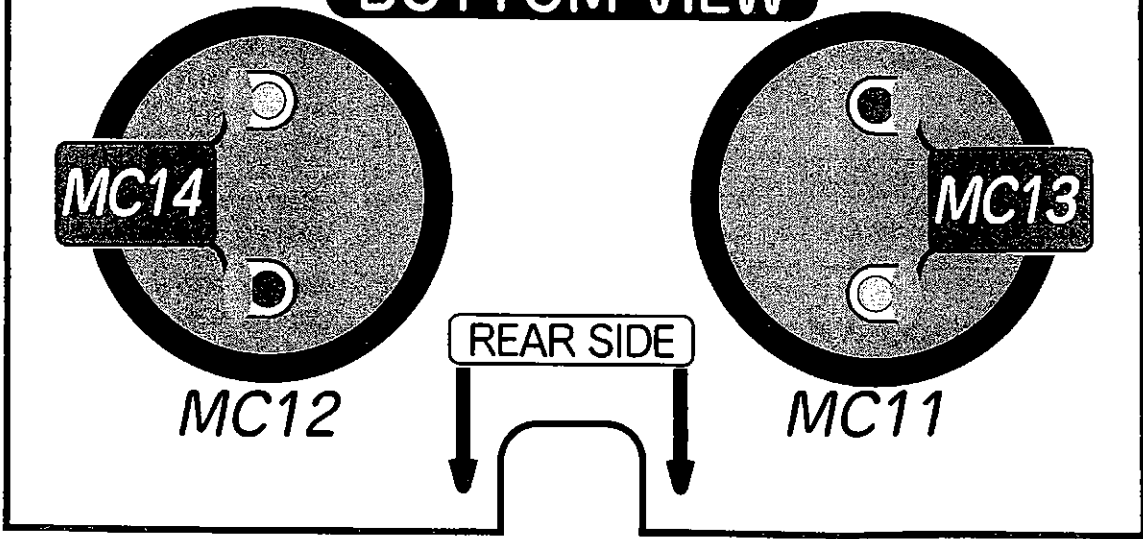

7. MECHANISM PARTS LIST / 機構部品表

7-1. AU-α907MR / α907MRX

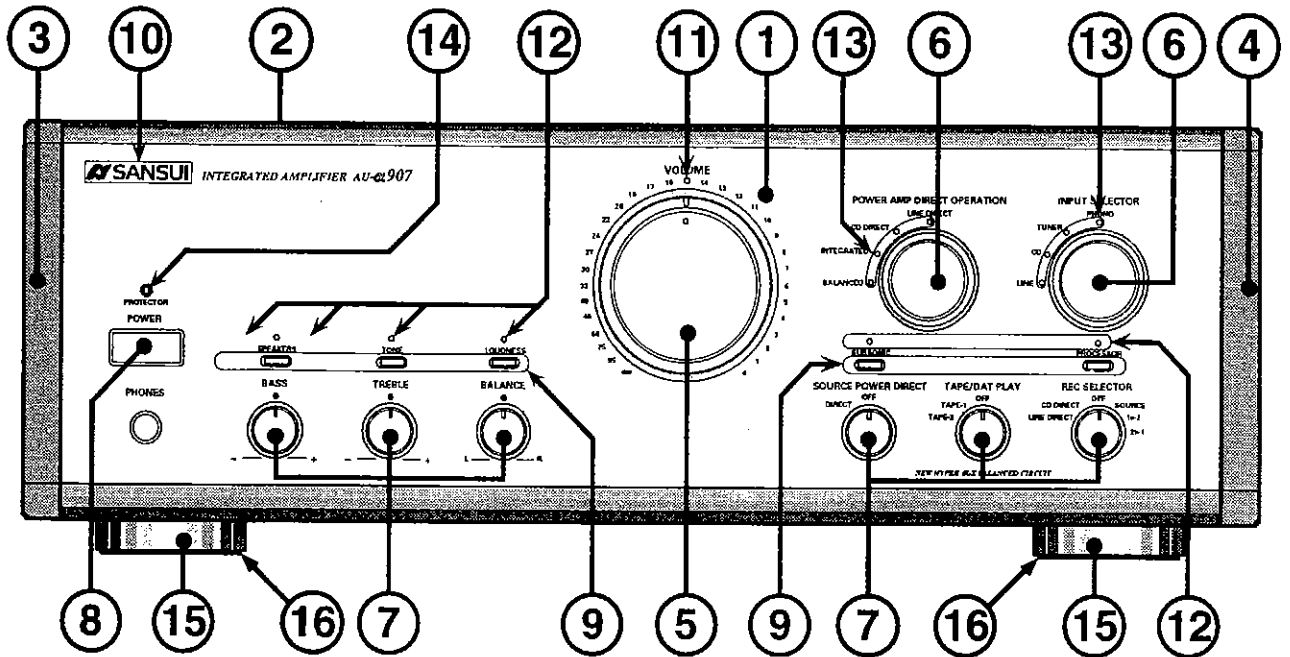

7-1. < AU-α907MR & AU-α907MRX >

Parts No.	Stock No.	Description
1	05341810	FRONT PANEL (00)
	05349910	FRONT PANEL (XX)
2	05282810	BONNET
3	05342900	SIDE WALL WOOD LEFT
4	05343000	SIDE WALL WOOD RIGHT
5	05349410	KNOB , MASTER VOLUME
6	05338500	KNOB , SELECTOR
7	05339000	KNOB , SELECTOR / VOLUME
8	05340200	KNOB , PLATE POWER

Parts No.	Stock No.	Description
9	05339800	KNOB , PUSHED KEY
10	05348200	LOGO BAGE "SANSUI"
11	05340700	INDICATOR , MASTER VOLUME
12	05340800	INDICATOR , ACCESSORY
13	05340900	INDICATOR , SELECTOR
14	05257600	INDICATOR , PWR. / PROTECTOR
15	05206510	LEG (COPPER)
16	05349200	CUSHION SHEET (SKIN) , LEG

707MRX

707MR

7-2. AU-707MR / 707MRX

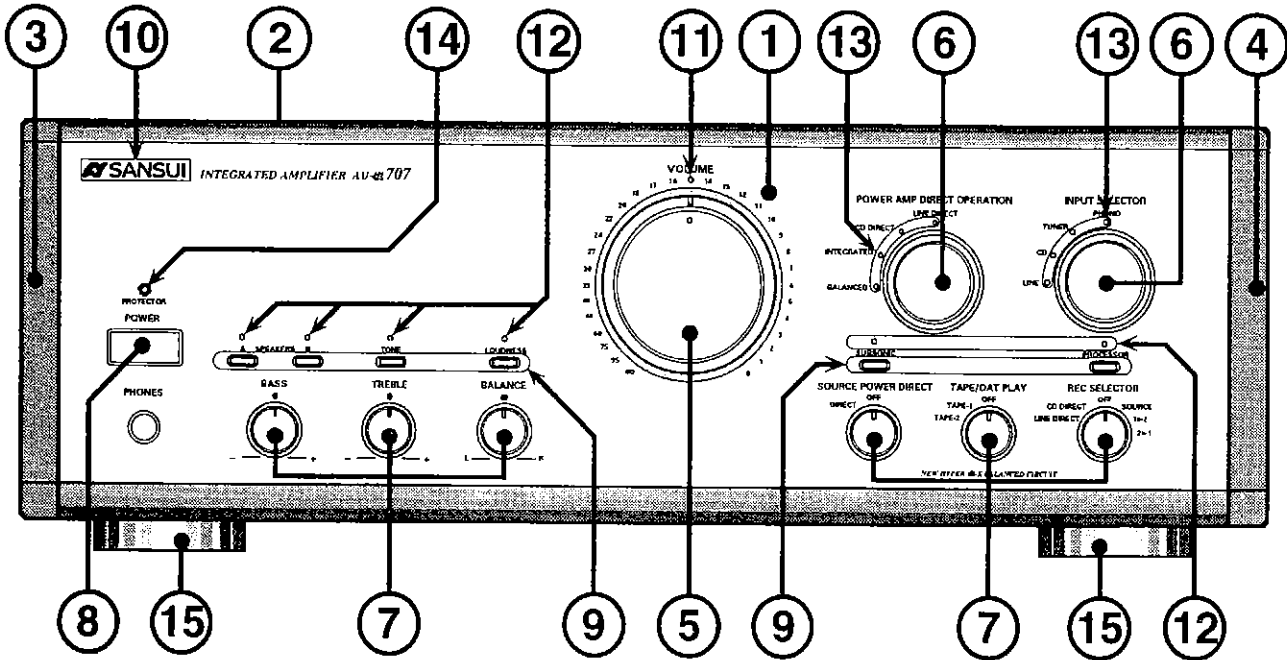

7-2. < AU-707MR & AU-707MRX >

Parts No.	Stock No.	Description
1	05341610	FRONT PANEL (00)
	05350110	FRONT PANEL (XX)
2	05084100	BONNET
3	05342900	SIDE WALL WOOD LEFT
4	05343000	SIDE WALL WOOD RIGHT
5	05338010	KNOB , MASTER VOLUME
6	05338500	KNOB , SELECTOR
7	05339000	KNOB , SELECTOR / VOLUME

Parts No.	Stock No.	Description
8	05340200	KNOB , PLATE POWER
9	05339800	KNOB , PUSHED KEY
10	05348200	LOGO BAGE "SANSUI"
11	05340700	INDICATOR , MASTER VOLUME
12	05340800	INDICATOR , ACCESSORY
13	05340900	INDICATOR , SELECTOR
14	05257600	INDICATOR , PWR. / PROTECTOR
15	05202900	LEG (CLEAR RESIN)

ⓧ607MR

ⓧ607MRX

7-3. AU-ⓧ607MR / ⓧ607MRX

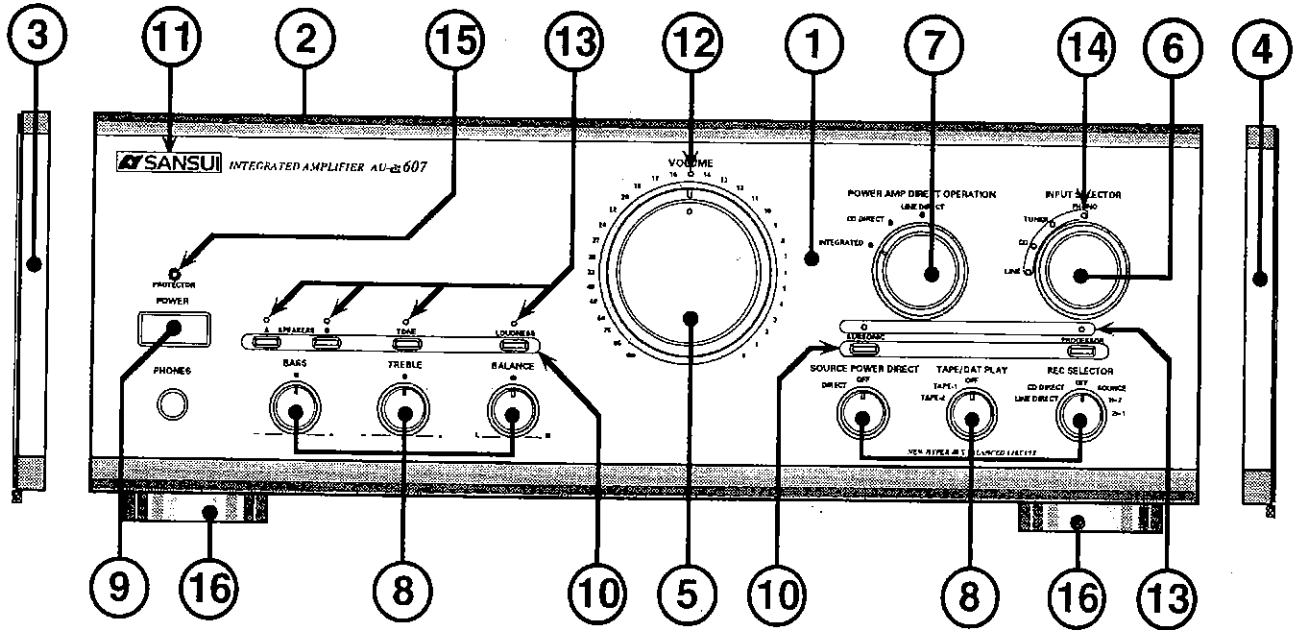

7-3. < AU-ⓧ607MR & AU-ⓧ607MRX >

Parts No. Stock No. Description

1	05341410	FRONT PANEL (00)	GOLD
	05341510	FRONT PANEL (00)	BLACK
	05350610	FRONT PANEL (XX)	GOLD
	05354310	FRONT PANEL (XX)	BLACK
2	05197500	BONNET	GOLD
	27700800	BONNET	BLACK
3	05339400	SIDE COVER LEFT	GOLD
	05339500	SIDE COVER LEFT	BLACK
4	05339600	SIDE COVER RIGHT	GOLD
	05339700	SIDE COVER RIGHT	BLACK
5	05338010	KNOB, VOLUME	GOLD
	05338110	KNOB, VOLUME	BLACK
6	05338500	KNOB, SELECTOR	GOLD
	05338600	KNOB, SELECTOR	BLACK

Parts No. Stock No. Description

7	05343900	KNOB, AMP. DIRECT	GOLD
	05344000	KNOB, AMP. DIRECT	BLACK
8	05339000	KNOB, SEL. / VOL.	GOLD
	05339100	KNOB, SEL. / VOL.	BLACK
9	05340200	KNOB, PLATE POWER	GOLD
	05340300	KNOB, PLATE POWER	BLACK
10	05339800	KNOB, PUSHED KEY	GOLD
	05339900	KNOB, PUSHED KEY	BLACK
11	05348200	LOGO BAGE "SANSUI"	GOLD
	05348100	LOGO BAGE "SANSUI"	BLACK
12	05340700	INDICATOR, MASTER VOLUME	
13	05340800	INDICATOR, ACCESSORY	
14	05340900	INDICATOR, SELECTOR	
15	05257600	INDICATOR, PWR. / PROTECTOR	
16	05202900	LEG (CLEAR RESIN)	

8. PACKING LIST / 梱包材部品表

8-1. < AU-@907MR & AU-@907MRX >

Parts No. Stock No. Description

1	05345100	CARTON CASE	(00)
	05345000	CARTON CASE	(XX)
2	05218700	PACKING , PROTECT CORNER	
3	05286210	POLYSTYRENE FORM PACKING	
4	05287400	POLYSTYRENE FORM CUSHION	
5	27214900	POLYETHYLENE FORM SHEET	
6	05261600	POLYETHYLENE BAG	

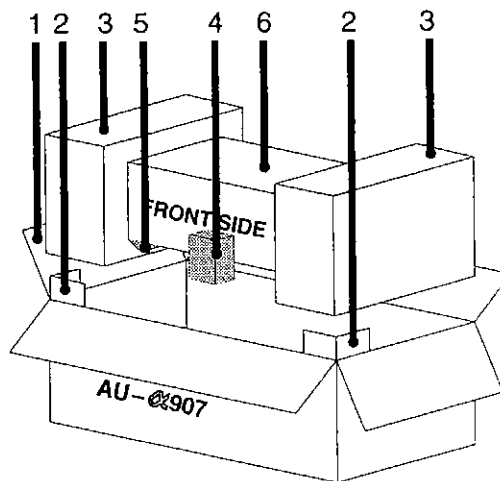

8-2. < AU-@707MR & AU-@707MRX >

Parts No. Stock No. Description

1	05344700	CARTON CASE	(00)
	05344800	CARTON CASE	(XX)
2	05286210	POLYSTYRENE FORM PACKING	
3	27214900	POLYETHYLENE FORM SHEET	
4	05261600	POLYETHYLENE BAG	

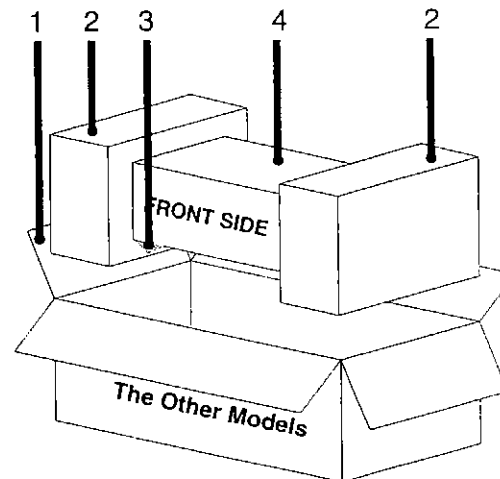

8-3. < AU-@607MR & AU-@607MRX >

Parts No. Stock No. Description

1	05344300	CARTON CASE	(00)	GOLD
	05344400	CARTON CASE	(00)	BLACK
	05344500	CARTON CASE	(XX)	GOLD
	05344600	CARTON CASE	(XX)	BLACK
2	05286210	POLYSTYRENE FORM PACKING		
3	27214900	POLYETHYLENE FORM SHEET		
4	05261600	POLYETHYLENE BAG		

9. ACCESSORY LIST / 付属品部品表

Stock No. Description

27939100	ENVELOPE , WARRANTY CARD	(00)
92900240	WARRANTY CARD (JAPAN)	(00)
47852000	POLYETHYLENE BAG	
07500640	WARRANTY CARD (EXPORT)	(XX)
92901370	SERVICE NETWORK (JAPAN)	(00)
92901150	SERVICE STATION LIST (EXPORT)	(XX)
27959600	POST CARD , USERS RETURN (JAPAN)	(00)

Stock No. Description

19094100	OPERATING INSTRUCTION 907 (JPN.)	(00)
19094400	OPERATING INSTRUCTION 907 (E / T)	(XX)
19094200	OPERATING INSTRUCTION 707 (JPN.)	(00)
19094500	OPERATING INSTRUCTION 707 (E / T)	(XX)
19094300	OPERATING INSTRUCTION 607 (JPN.)	(00)
19094600	OPERATING INSTRUCTION 607 (E / T)	(XX)

SANSUI

SANSUI ELECTRIC CO., LTD. :

SANSUI INTERNATIONAL CO., LTD. :

SANSUI USA INC. :
SANSUI DEUTSCHLAND G.M.B.H. :
山水電気株式会社

22 Sekinoue, Namekawa, Sukagawa-shi, Hukusima-ken 962-04, Japan
Phone: (0248) 75-4174 / Fax: (0248) 76-6445
Units B10-B11, 2/F, Block B Hoplite Industrial Centre 3-5 Wang Tai Road,
Kowloon Bay Kowloon, Honk Kong
17150 South Margay Ave. Carson, California 90746 U.S.A.
Paul Ehrlich Strasse 8, 6074Rödermark 2, F. R. Germany
福島県須賀川市大字滑川字関の上 2 2 (〒962-04)

A3890 - A3910, A3990 - A4010 (SM 2 - 429) Printed in H / K (1996.09.SI) <Stock No.36733100>