

OPERATING INSTRUCTIONS & SERVICE MANUAL

SOLID-STATE BASIC AMPLIFIER

SANSUI BA-60



Sansui

SANSUI ELECTRIC COMPANY LIMITED

Welcome to the group of proud owners of the SANSUI BA-60, a solid state stereophonic basic amplifier from the manufacturer of some of the world's finest audio components. Both in appearance and performance, the BA-60 is thoroughly professional. Not a single detail has been overlooked in designing and manufacturing the BA-60 for optimum performance, not only through numerous electrical and mechanical measurements, but by subjecting it to repeated listening tests. The end result is a moderately priced stereophonic basic amplifier without any of those weaknesses sometimes found on popular priced products. It is ideal for use in an electronic crossover system for the truest high fidelity sound reproduction ever.

It is now up to you to read the instructions contained in this booklet to fully enjoy all the advanced performance capabilities built into the BA-60.

CONTENTS

OPERATING INSTRUCTIONS	
SWITCHES AND CONTROLS	3
CONNECTIONS.....	4
ELECTRONIC CROSSOVER SYSTEM	5, 6
HINTS ON USE	7, 8
SPECIFICATIONS/CHARACTERISTICS	
SCHEMATIC DIAGRAM.....	10
SERVICE MANUAL	
TROUBLESHOOTING CHART	
TEST POINTS	11
ADJUSTMENT.....	13
DISASSEMBLY PROCEDURE.....	14
DISASSEMBLY PROCEDURE.....	15
PRINTED CIRCUIT SHEETS AND	
PARTS LIST	16
OTHER PARTS AND THEIR POSITION	
ON CHASSIS.....	17

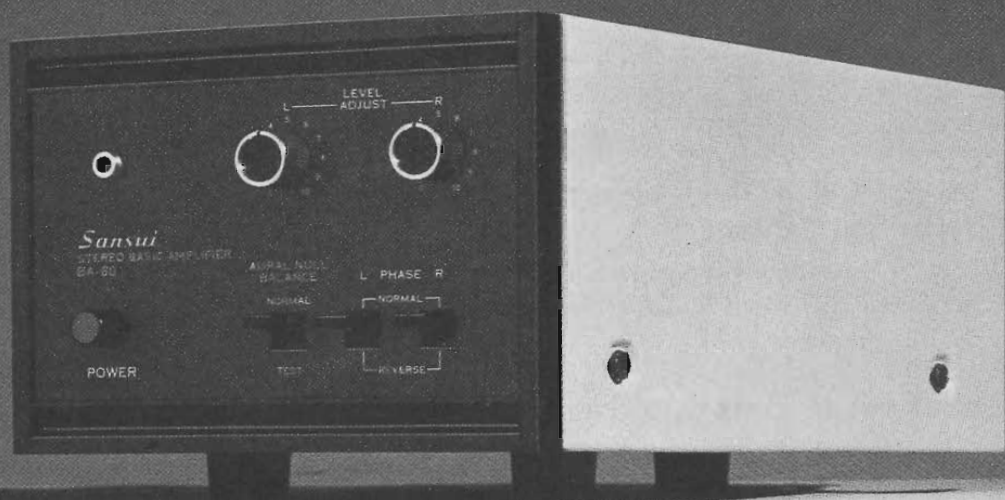

Sansui
STEREO BASIC AMPLIFIER
BA-60

LEVEL
ADJUST

AURAL ADJUST
BALANCE

L PHASE R

POWER

TEST

REVERSE

SWITCHES AND CONTROLS

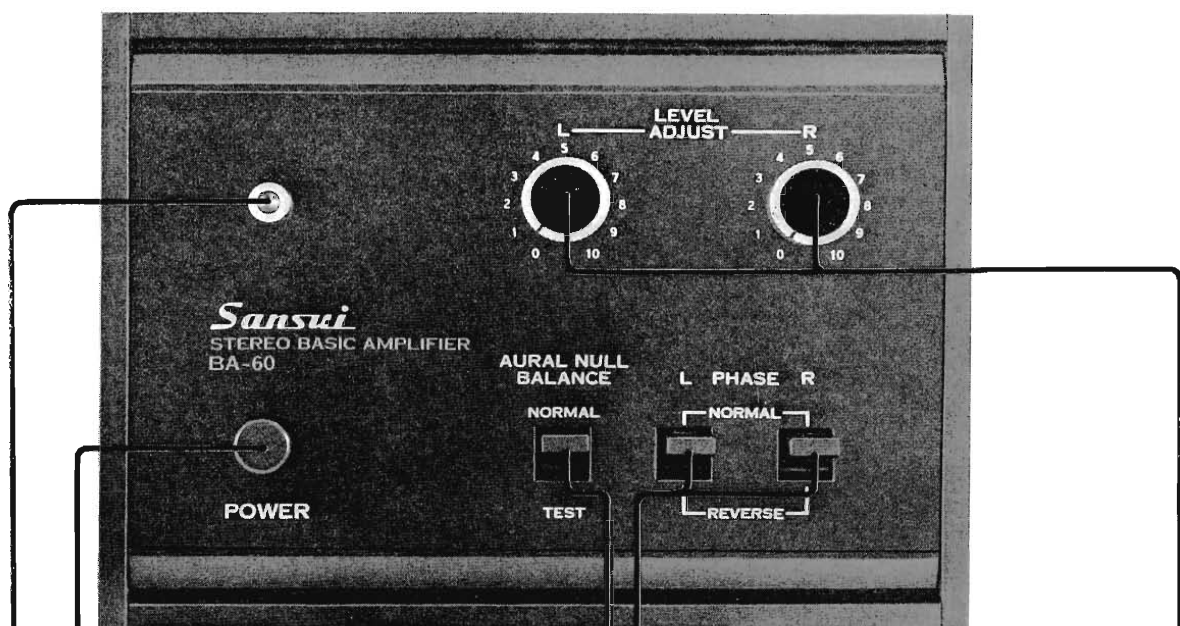

Power Switch

Turns power supply on and off. Push it once to turn on, and push it again to turn off.

Power Indicator

Lights up in orange when power is turned on, and remains lit to indicate the amplifier is in operation.

Aural Null Balance Switch

Use to balance the sound volumes from the right and left speakers. To balance, feed monophonic signals to the right and left input terminals, and set this switch in the TEST position. Then, after turning both LEVEL ADJUST controls up to the "5" mark once, turn down either control so that little or no sound will be heard from both speakers. Keep this switch in its NORMAL position at all other times.

Level Adjust Controls

Use to control the sound volumes from the speakers. Turn them clockwise to increase volume, and counterclockwise to reduce it. The left control adjusts the sound volume from the left speaker, and the right control the sound volume from the right speaker.

Phase Reversing Switch

Reverse the phasing (+ and -) between the amplifier and speakers.

CONNECTIONS

Connecting Speakers

- 1) Connect the (+) terminal of the left speaker with the (+) LEFT speaker terminal on the rear panel of the amplifier, and the (-) terminal of the same speaker with the (-) LEFT speaker terminal.
- 2) Connect the (+) terminal of the right speaker with the (+) RIGHT speaker terminal on the rear panel of the amplifier, and the (-) terminal of the same speaker with the (-) RIGHT speaker terminal.

terminal of the same speaker with the (-) RIGHT speaker terminal.

Connecting Input Sources

- 1) Connect the left channel output of a pre-amplifier (or tuner) to the LEFT INPUT terminal on the rear of the amplifier.
- 2) Connect the right channel output of a pre-amplifier (or tuner) to the RIGHT INPUT terminal.

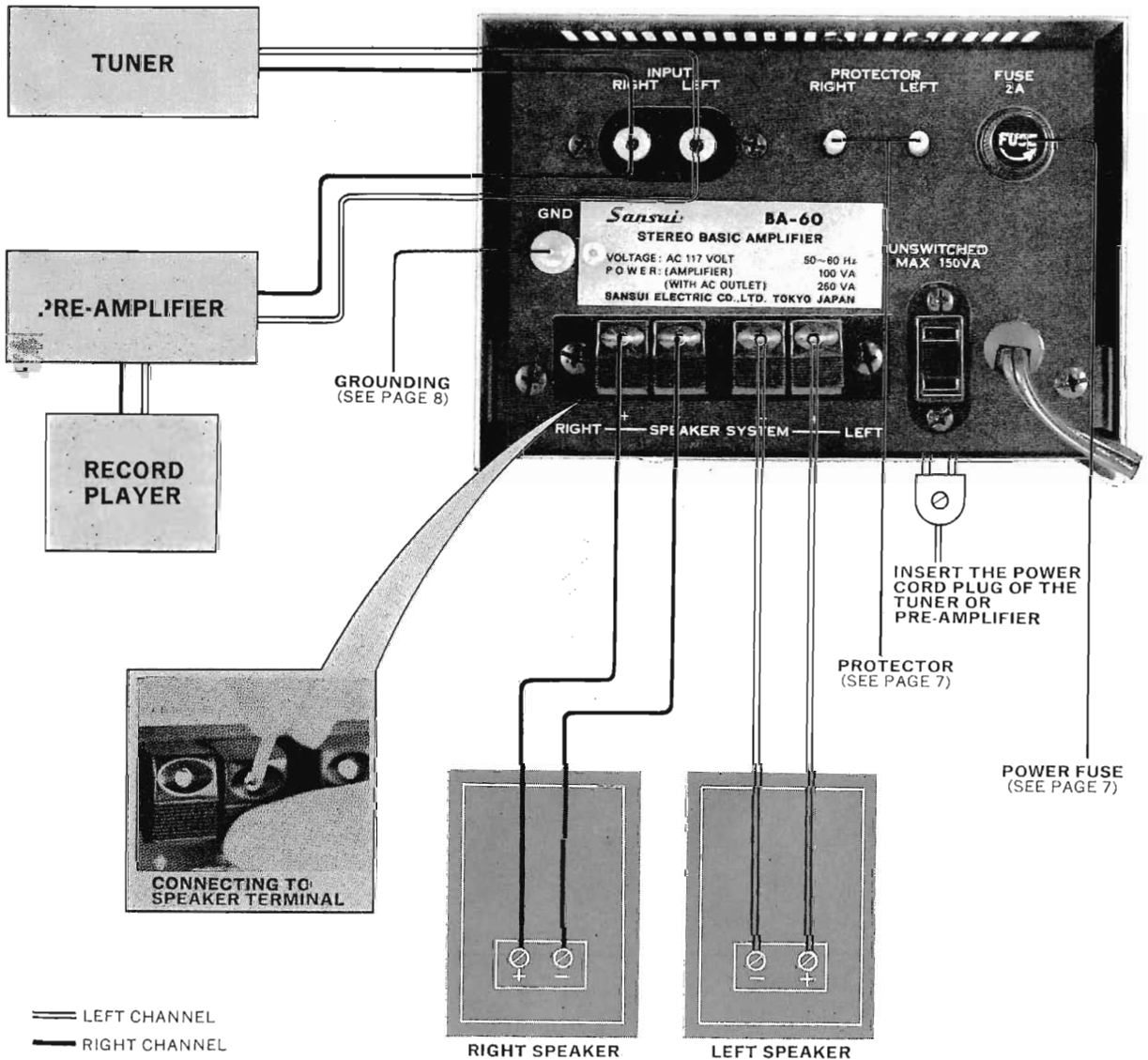

ELECTRONIC CROSSOVER SYSTEM

An electronic crossover system is a highly sophisticated system of hi-fi sound reproduction, and offers a number of outstanding advantages over the conventional crossover network system. By using the SANSUI BA-60 or BA-90 basic amplifier or the SANSUI AU-777 or AU-555 amplifier in conjunction with the SANSUI CD-5 electronic crossover unit, it is possible to achieve an electronic crossover system at a surprisingly low cost. In the case of the SANSUI AU-777 and AU-555, their pre-amplifier and basic amplifier sections are built for independent usage, the latter section being available for driving a separate speaker in an electronic crossover system. Since details of the correct usage of these amplifiers in an electronic crossover system depends much on the speakers and other basic amplifiers used, it is best to consult your nearest SANSUI dealer if you wish to construct an electronic crossover system using these amplifiers.

FULL-RANGE SPEAKER SYSTEM

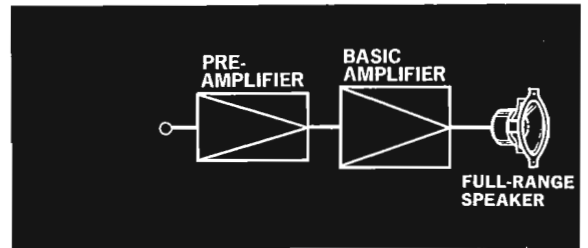

3 WAY CROSSOVER NETWORK SYSTEM

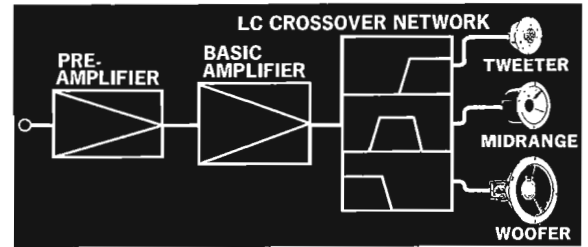

TRI-AMPLIFICATION ELECTRONIC CROSSOVER SYSTEM

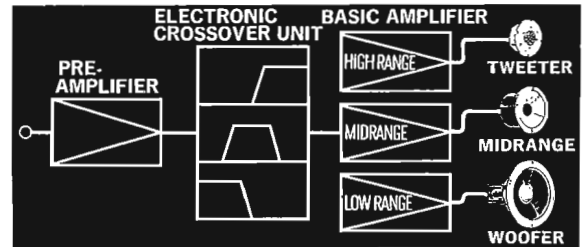

Electronic Crossover System Using the BA-60

Connect the outputs of a pre-amplifier to the input terminals of the SANSUI CD-5 electronic crossover unit, which divides the signals into high, medium and low ranges (or channels). Then simply couple three BA-60's or BA-90's or a combination of them to separate output terminals of the CD-5, feeding their outputs separately into individual speakers, as illustrated in the diagram.

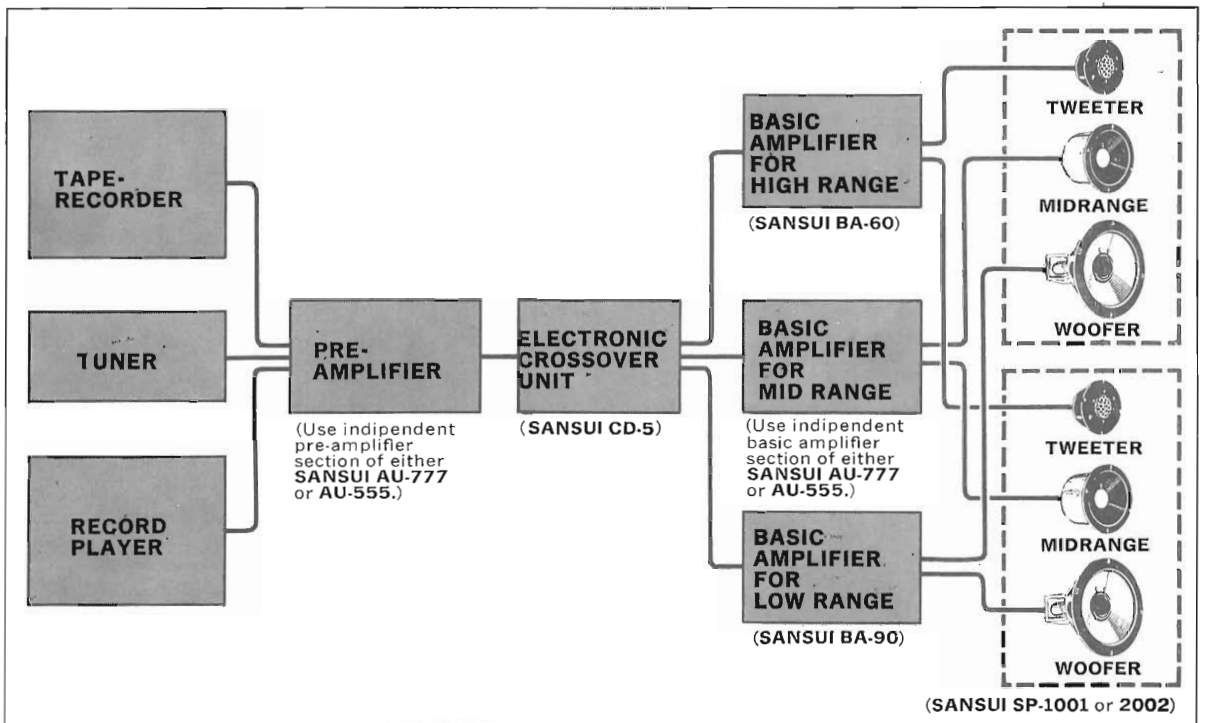

HINTS ON USE

Voltage Change-over Plug

The BA-60 allows you to change over the working voltage of the primary side of its power supply circuit simply by shifting a plug among its four positions: 100V, 117V, 220V and 240V. The plug is usually set for the power supply voltage in your area, but if it should be different, reset the plug in the correct position. Simply insert the plug so that the arrow mark on it points at the correct voltage indication.

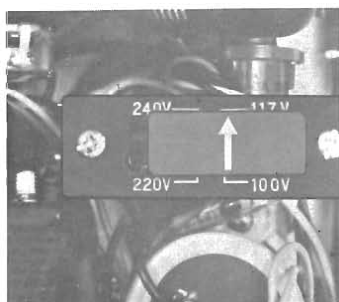

Should the Power Fuse Blow...

Should the amplifier fail to operate and you find it is because the power fuse has blown, remove the power cord from the wall outlet and then replace the blown fuse with a new glass-tubed 2-ampere fuse. Using a piece of wire or a fuse of a different capacity as a stop-gap measure is very dangerous and could lead to a serious trouble. If you think the power fuse has blown because of a trouble in the amplifier, discover and eliminate the trouble first before replacing it.

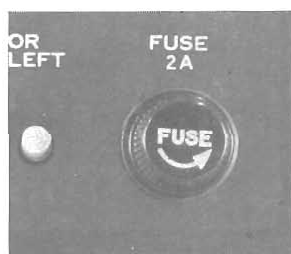

Should the Protector Operate...

While your BA-60's expensive silicon power transistors are sufficiently protected in circuit design, a circuit breaker (protector) is also incorporated to doubly protect them under all operating conditions. Should the output circuit be short-circuited for some reason or should excessively large inputs flow in from the input circuit and an overcurrent flood the power transistors, the protector goes into operation to protect the power transistors. No sound will then be heard from both or one of the speakers. There is also the possibility that the protector operates because of a momentary overcurrent. So if you hear no sound from either or both speakers after you have turned on power and the power indicator has lit up, it is very likely that the protector has operated to protect the power transistors. Should this happen, turn off power immediately. Wait about 5 seconds and then push the red protector restoring buttons on the rear of the amplifier. Turn on power again and if the amplifier should still fail to operate normally, turn off power again and check the speaker terminals and speaker cords once for a short-circuit. If it seems that something has gone wrong with the amplifier itself, contact your nearest SANSUI dealer.

Heat Radiation

Transistors being relatively sensitive to heat, the BA-60 is designed so that any heat radiated will effectively escape through the amplifier's bonnet. Therefore, placing something on or top of the amplifier, encasing it in a tight cabinet or operating it in direct sunlight may lead to a breakdown.

If any one of these situations cannot be avoided, take special care to increase heat dissipation.

AC Outlet

The AC outlet on the amplifier's rear panel has a maximum capacity of 150VA and is intended for supplying power for other audio components such as a pre-amplifier. Coupling a component with a greater power requirement to the outlet is very dangerous, for it may cause the amplifier to break down.

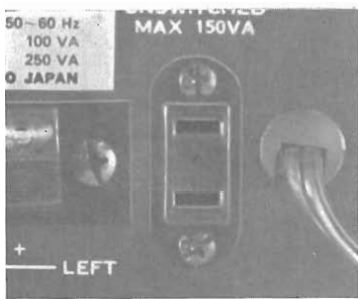

Grounding

Connect one end of a piece of PVC wire or enameled wire to the GND terminal on the left side of the amplifier's rear panel, then attach a small copper plate to the other end and bury it deep underground. Grounding the amplifier in this manner usually reduces noise. Also, if you are using the BA-60 in conjunction with a phonograph, tuner and tape recorder, connect their grounding wires to the GND terminal. This will usually reduce hum to a great extent. **CAUTION:** Be sure that the power cord is removed from the wall AC outlet when making grounding connections.

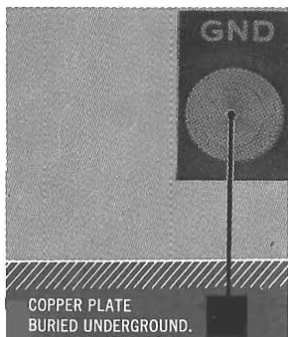

Should the Speaker Polarities Differ...

Should the right and left speakers be connected out of phase with each other (i.e., should they differ in polarity connections), reproduced sound will be weak in the center, with bass response particularly weakened. This condition will be very conspicuous when you play a monophonic record on a stereo phonograph, listen to an FM Mono broadcast or any music program on any broadcast band. To correct the wrong polarity connections, simply set either PHASE switch in its REVERSE position. Once the polarities are thus matched, the two speakers will sound as if there were only one speaker in the center producing sound.

Make Proper Connections

Be sure that the connections between the lead wires of various input and output components and the respective input and output terminals are complete. If the lead wires are loose or in touch with other parts, the amplifier may not only fail to operate normally, but it may induce noise and even cause the amplifier to break down over a long period of time. Also be sure that any component connected to the pre-amplifier, such as a phonograph or tape recorder, is properly connected in accordance with the manufacturer's instructions.

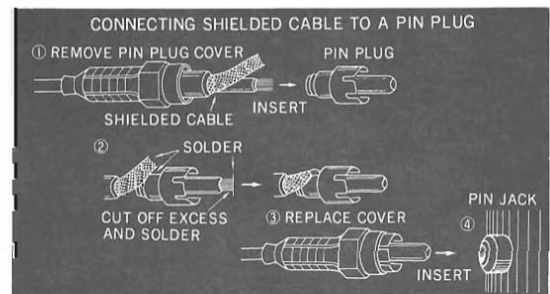

SPECIFICATIONS / CHARACTERISTICS

RATED POWER OUTPUT:

MUSIC POWER (IHF): 60W (4 ohms)
50W (8 ohms)

CONTINUOUS POWER:

25W/25W (4 ohms)
20W/20W (8 ohms)

TOTAL HARMONIC DISTORTION:

Less than 0.3%

INTERMODULATION DISTORTION:

(60Hz : 7,000Hz = 4:1)
Less than 0.5%

POWER BANDWIDTH (IHF): 20~40,000Hz(8 ohms)

FREQUENCY RESPONSE: 20~60,000 Hz ± 1 dB
(8 ohms; at rated output)

INPUT SENSITIVITY: per 1,000Hz input required to deliver rated continuous output): 0.7V

INPUT IMPEDANCE: More than 50k ohms

LOAD IMPEDANCE: 4~16 ohms

DAMPING FACTOR: Over 46 (8 ohms)

HUM AND NOISE (IHF): Better than 80 dB

CHANNEL SEPARATION: Better than 50dB

CIRCUIT COMPLEMENT:

13 transistors (2SD247 $\times 4$, 2SC734 $\times 4$, 2SA561 $\times 2$,
2SD247 $\times 2$, CDC8002-1 $\times 1$), 1 diode (1S-1850),
4 varistors(DS-410 $\times 4$)

POWER VOLTAGE: 100V, 117V, 220V, 240V
AC, 50/60Hz

POWER CONSUMPTION: 100VA (max.)

DIMENSIONS: 6" W \times 4-3/8" H \times 10-3/8" D

WEIGHT: 9.2 lbs.

POWER BANDWIDTH CHARACTERISTIC

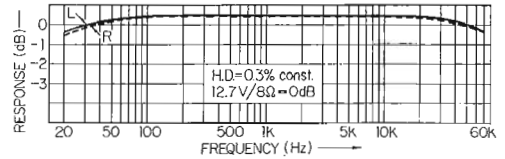

MUSIC POWER CHARACTERISTIC

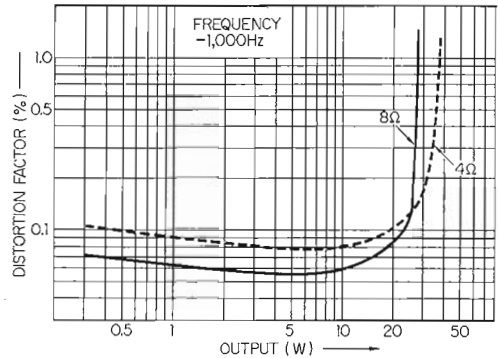

INTERMODULATION DISTORTION CHARACTERISTIC

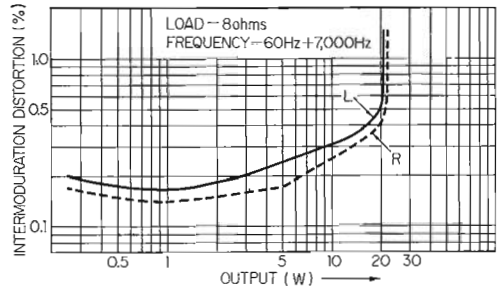

TOTAL HARMONIC DISTORTION CHARACTERISTIC

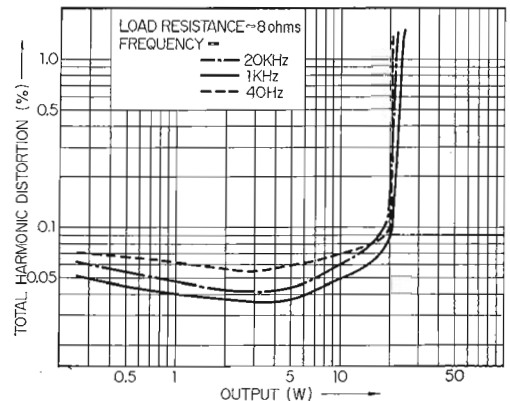

* All rights reserve specifications subject to change without notice.

SCHEMATIC DIAGRAM

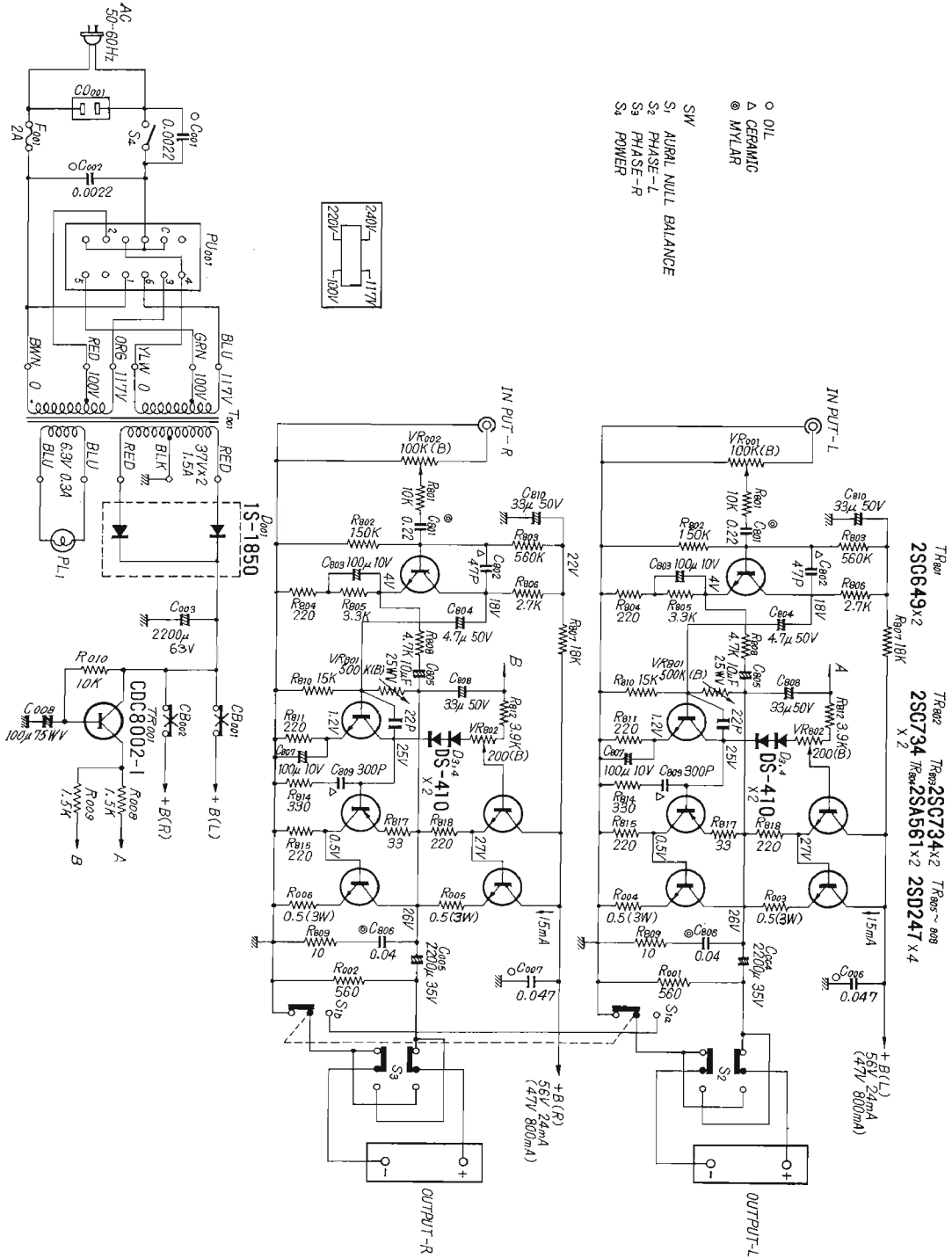

TROUBLESHOOTING CHART

A Quick Check List

- 1) **Connections:** Are other components properly connected to the amplifier? Is the amplifier properly plugged into the wall AC outlet?
- 2) **Operation:** Are you operating the amplifier correctly as instructed in this booklet?
- 3) **Installation:** Is the amplifier properly positioned in relation to the speakers and phono-

graph?

4) **Defective components:** Are the audio components connected to the amplifier defective?

5) **Performance characteristic:** Are you not placing an excessive strain on the amplifier to raise some particular performance characteristic?

PROGRAM	SYMPTOM	PROBABLE CAUSE	REMEDY
Radio broadcast	Constant or intermittent noise heard at certain hours or in a certain area.	Electric discharge or oscillation by a fluorescent lamp, TV, series motor, electrical contact, rectifier, oscillator, etc. Insufficient antenna input due to long distance from broadcast stations or obstruction of signals by mountains or high ferro-concrete buildings. Interference by other radio waves. Natural phenomena such as an atmospheric discharge and lightning.	Attach a noise suppressor to the tuner or the electrical appliance producing the noise. Place the tuner away from the electrical appliance producing the noise. Install an outdoor antenna and ground the amplifier to improve its S/N ratio. If the noise occurs at a certain frequency, attach a wave trap to the antenna input circuit of the tuner. Reverse the inserted position of the power cord plug.
	Noise heard on AM band at certain hours, in a certain area or at particular broadcast frequencies.	Insufficient signal strength.	Install an outdoor AM antenna, or if it is already installed, re-position it for best reception. Ground the amplifier and/or reverse the inserted position of the power cord plug.
	High-frequency noise.	Interference by adjacent channel (beat interference). TV set near to the amplifier is in use	While noise due to such causes cannot be eliminated by adjusting the amplifier, it can be made less disturbing by turning down the TREBLE tone control or turning on the HIGH filter switch on the preamplifier. Move the amplifier away from the TV set.
	FM broadcast reception is noisy.	Poor noise limiter effect and lowered SN ratio due to insufficient antenna input, resulting either from poorly positioned FM antenna or long distance from stations.	Re-position the FM antenna for the least noise and best reception. If this proves ineffective, install an exclusive outdoor FM antenna and position it for the best reception.

PROGRAM	SYMPTOM	PROBABLE CAUSE	REMEDY
Radio broadcast (cont'd)	NOTE: Quality of FM broadcast reception is largely affected by the transmitting conditions (such as antenna efficiency) of broadcast stations. So you may receive one station quite well while having difficulty in receiving another. Scratchy noise on FM band. Noise heard with FM MPX broadcasts that was not heard with FM monophonic broadcasts.	Ignition noise made by the starting of a nearby automobile engine (particularly loud near 15MHz on dial scale). Unavoidable because of the nature of FM MPX signals which cut down effective service area to half that of FM monophonic signals.	TV antenna may be shared for FM broadcast reception, but be sure to use a divider and make certain the TV reception is not affected. Excessively long antenna may increase noise. No effective remedy except to move the antenna as far away from the street as possible or increase the antenna input as instructed above. Position the antenna so as to maximize the antenna input. Turning on HIGH FILTER Switch and/or turning down TREBLE tone control may considerably reduce the noise.
Record and tape	Hum or howling Surface noise.	Phonograph is placed on top of or near one of the speakers. Use of wire other than shielded wire. Incomplete connection. Connection cord too close to power cord and/or electrical appliances such as a fluorescent lamp. Existence of an amateur radio station or TV transmitting antenna in the vicinity. Worn or damaged record, or dust on record. Worn stylus, or dust on stylus. Improper stylus pressure.	Place a cushion underneath the phonograph. Try changing the location of the phonograph and speakers. Use regular shielded wire to make interconnections. Turning on LOW FILTER switch may help. Minimize the length of connection cord. Refrain from turning up BASS tone control too high. Consult your nearest governmental (or municipal) radio regulatory office. Turning down TREBLE tone control or turning on HIGH FILTER switch may help. Recondition (or replace) the phonograph stylus or tape head.
All programs	BALANCE control is off the center position when sound volumes in the right and left channels are balanced.	Position of the BALANCE control which gives equal sound volume from both channels varies from program to program.	Set the preamplifier's MODE switch in MONO and adjust its BALANCE control for equal sound volume from both channels. Or make more precise adjustment using the AURAL NULL BALANCE switch on this amplifier. Check if the efficiency of one speaker is balanced with that of the other.

ALIGNMENT

TEST POINTS

Only the test points for one of the stereo channels are indicated here, but test points also exist at the same positions on the corresponding printed circuit sheet for the other channel.

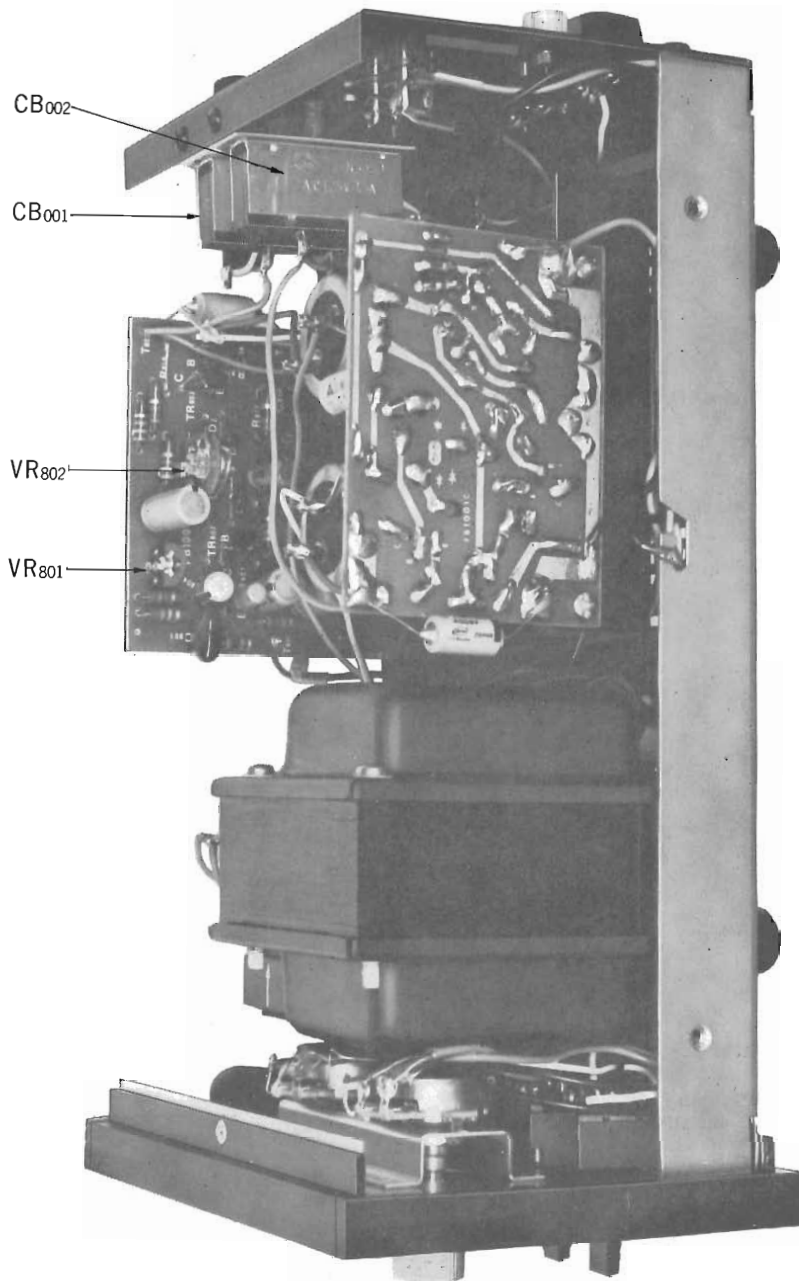

OUTPUT ADJUSTMENT

STEP	CONNECT/ADJUST	REMARKS
1.	Turn down variable resistors VR ₀₀₁ and VR ₀₀₂ to a minimum.	
2.	Set audio oscillator at 1,000Hz and connect it to left (right) channel INPUT terminal.	Use audio oscillator with oscillating frequency range of 20 to 20,000Hz and output voltage of 200mV or more
3.	Connect 8 or 16 ohm resistor with capacity of more than 50W to left (right) channel speaker terminal.	
4.	Connect oscilloscope to speaker terminal.	Adjust one channel at a time.
5.	Turn on power, raise volume slowly and confirm on oscilloscope that there is output at the speaker terminal.	
6.	Adjust VR ₈₀₁ for left channel so that both peaks of output waveform (sine wave) will be clipped simultaneously. Make similar adjustment with VR ₈₀₁ for right channel.	

CURRENT ADJUSTMENT

STEP	AMMETER (TESTER)	CONNECT/ADJUST	REMARKS
1.		Insert 16 ohm resistor between upper terminal of CB ₀₀₁ and CB ₀₀₂ and earth to see if CB ₀₀₁ and CB ₀₀₂ operate. If they operate, remove the resistor.	Use ammeter with a 100mA or 50mA range.
2.		Turn down VR ₀₀₁ and VR ₀₀₂ to a minimum.	
3.		Turn on power switch.	
4.	Set in 100mA range.	Connect lower terminal of CB ₀₀₁ to (+) terminal of ammeter, and upper terminal to its (-) terminal.	Be sure to turn on power switch before connecting ammeter.
5.		Adjust VR ₈₀₂ on left channel PC board so that ammeter will indicate 14 to 18mA if room temperature is below 25°C, and 18 to 22mA if it is over 25°C.	
6.	Set in 100mA range.	Connect lower terminal of CB ₀₀₀ to (+) terminal of ammeter, and upper terminal to its (-) terminal.	Be sure to turn on power switch before connecting ammeter.
7.		Adjust VR ₈₀₂ on right channel PC board so that ammeter will indicate 14 to 18mA if room temperature is below 25°C, and 18 to 22mA if it is over 25°C.	
8.		Push both red protector restoring buttons (for CB ₀₀₁ and CB ₀₀₂) on amplifier's rear panel.	

DISASSEMBLY PROCEDURE

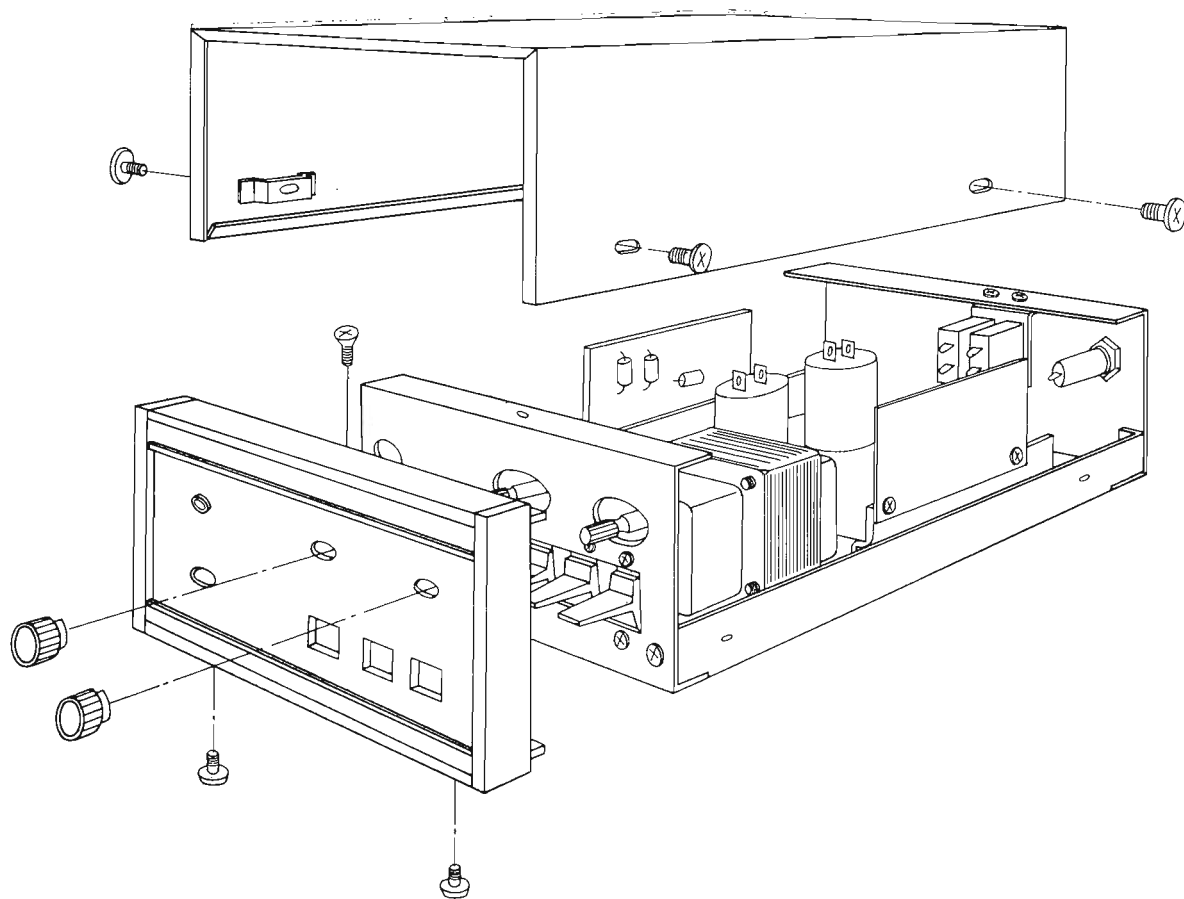

PRINTED CIRCUIT SHEETS AND PARTS LIST

X: Parts No Y: Parts Name Z: Position of Parts

DRIVER AMP. BLOCK <FB-1001C>

X	Y	Z
R801	10kΩ ±10% ½W Solid Resistor	1 A
R802	150kΩ ±10% ½W Solid Resistor	2 A
R803	560kΩ ±10% ½W Solid Resistor	1 A
R804	220Ω ±10% ¼W Carbon Resistor	2 A
R805	3.3kΩ ±10% ½W Solid Resistor	2 A
R806	2.7kΩ ±10% ½W Solid Resistor	1 A
R807	18kΩ ±10% ½W Solid Resistor	1 B
R808	4.7kΩ ±10% ½W Solid Resistor	2 A
R809	10Ω ±10% ½W Solid Resistor	2 B
R810	15kΩ ±10% ½W Solid Resistor	2 A
R811	220Ω ±10% ½W Solid Resistor	2 A
R812	3.9kΩ ±10% ½W Solid Resistor	1 B
R814	330Ω ±10% ½W Solid Resistor	2 B
R815	220Ω ±10% ½W Solid Resistor	2 B
R817	33Ω ±10% ½W Solid Resistor	2 B
R818	220Ω ±10% ½W Solid Resistor	1 B
C801	0.22μF ±10% 50 WV Mylar Capacitor	1 A
C802	47pF ±10% 50 WV Ceramic Capacitor	1 A

X	Y	Z
C803	100μF 10 WV Electrolytic Capacitor RB	2 A
C804	4.7μF 50 WV Electrolytic Capacitor RB	1 A
C805	10μF 25 WV Electrolytic Capacitor RB	2 B
C806	0.04μF ±10% 50 WV Mylar Capacitor	2 B
C807	100μF 10 WV Electrolytic Capacitor RB	2 A
C808	33μF 50 WV Electrolytic Capacitor RB	1 A
C809	300pF ±10% 50 WV Ceramic Capacitor	2 A
C810	33μF 50 WV Electrolytic Capacitor RB	2 A
TR801	2SC649 (0305091)	1 A
TR802	2SC734 (030536)	1 A
TR803	2SC734 (030536)	1 B
TR804	2SA561 (030010)	2 B
D3	DS-410 (031046)	1 B
D4	DS-410 (031046)	1 A
VR801	500kΩ(B)AC Balance Adjustor(103050)	1 A
VR802	200Ω(B)DC Bias Adjustor (103012)	1 B

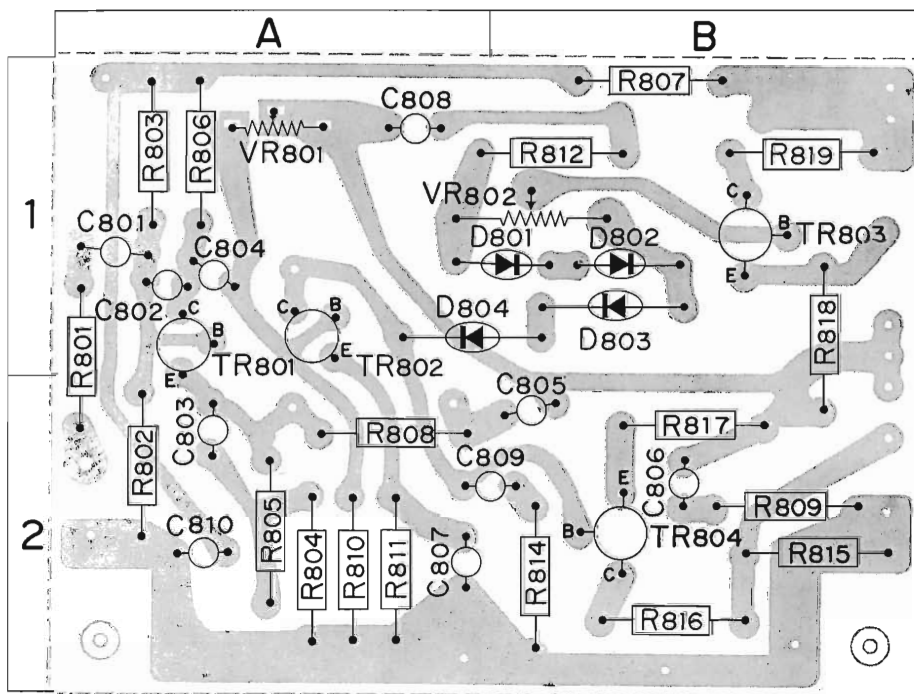

Only the printed circuit sheet for one of the stereo channels and the list of parts on it are presented here, but those for the other channel are exactly identical.

OTHER PARTS AND THEIR POSITION ON CHASSIS

X: Parts No Y: Parts Name

X	Y
R001	560Ω ±10% ½W Solid Resistor
R002	560Ω ±10% ½W Solid Resistor
R003	0.5Ω ±10% 3 W Cement Resistor
R004	0.5Ω ±10% 3 W Cement Resistor
R005	0.5Ω ±10% 3 W Cement Resistor
R006	0.5Ω ±10% 3 W Cement Resistor
R008	1.5kΩ ±10% ½W Solid Resistor
R009	1.5kΩ ±10% ½W Solid Resistor
R010	10kΩ ±10% ¼W Carbon Resistor
C001	0.0022μF ±20% 60WV Oil Capacitor
C002	0.0022μF ±20% 60WV Oil Capacitor
C003	2200μF 63WV Electrolytic Capacitor (020541)
C004	2200μF 35WV Electrolytic Capacitor (020542)
C005	2200μF 35WV Electrolytic Capacitor (020542)
C006	0.047μF ±10% 400WV Oil Capacitor
C007	0.047μF ±10% 400WV Oil Capacitor
C008	100μF 75WV Electrolytic Capacitor
VR001	100kΩ(B) 24φ Level Adjustor (100022)
VR002	100kΩ(B) 24φ Level Adjustor (100022)
D001	IS-1850 (031053)
CB001	Circuit Breaker (190001)
CB002	Circuit Breaker (190001)
TR805	2SD247 (030819,-1)
TR806	2SD247 (030819,-1)
TR807	2SD247 (030819,-1)
TR808	2SD247 (030819,-1)
TR001	CDC 8002-1 (030555,-1,-2)
S1	Aural Null Balance Switch (117009)
S2	Phase Switch (117009)
S3	Phase Switch (117009)
S4	AC Power Switch (113009)
PU001	Voltage Selector Switch (241008/241009)
F001	2A Fuse (043003)
CO001	AC Outlet (245001-1)
T001	Power Transformer (400037)
PL1	8V 150mA Pilot Lamp (040005)

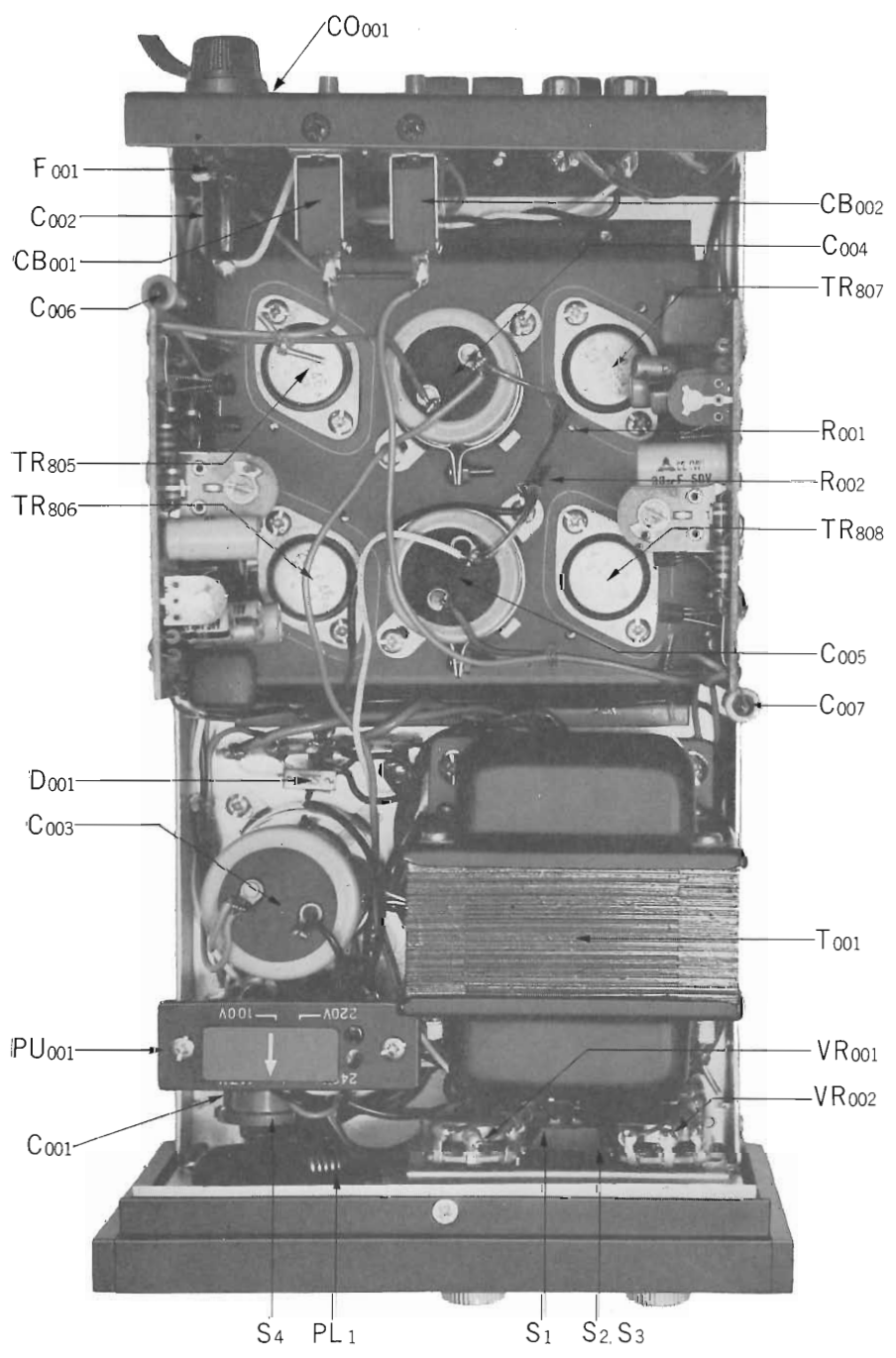



SANSUI ELECTRIC COMPANY LIMITED

Head Office; 14-1, 2-chome, Izumi, Suginami-ku, Tokyo, Japan. TEL. 323-1111

Printed in Japan (41500M3)