

SERVICE MANUAL

STEREO PREAMPLIFIER

SANSUI C-55

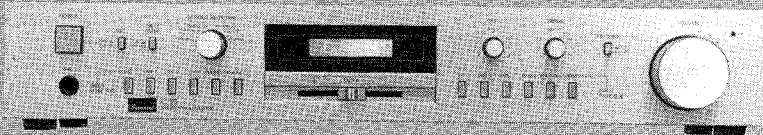

● SPECIFICATIONS

Total harmonic distortion (1,000 Hz)	
TUNER, TAPE PLAY	less than 0.03 % at 1 V
Frequency response (at 0.5V)	5 to 50,000 Hz, +0.5 dB, -2 dB
RIAA curve deviation (PHONO, 20 Hz to 20 kHz)	+0.5 dB, -0.5 dB
Input sensitivity and impedance (1,000 Hz)	
PHONO-1, 2	2.5 mV/47 kilohms (Max. input capability; 150 mV at 1 kHz, less than 0.1 % total harmonic distortion)
TUNER, TAPE PLAY	150 mV/47 kilohms
MIC	1.8 mV/100 kilohms
GUITAR	18 mV/100 kilohms
Output level (1,000 Hz)	
TAPE REC	150 mV
OUTPUT	1.0 V
Signal to noise ratio (short-circuit, A-network)	
PHONO-1, 2	75 dB
TUNER, TAPE PLAY	90 dB
Controls	
BASS	+10 dB, -10 dB (50 Hz)
TREBLE	+10 dB, -10 dB (10 kHz)
HIGH FILTER	-3 dB (7 kHz), 6 dB/oct.
LOUDNESS	+8 dB (50 Hz)
(Volume control)	-30 dB
	+5 dB (10 kHz)
Power requirements	
Power voltage	110 ~ 120, 220 ~ 240 V (50/60 Hz)
For USA and Canada	120 V (60 Hz)
Power consumption	7 watts Rated 8 watts Maximum
Dimensions	430 mm (16-15/16") W 74 mm (2-15/16") H 249 mm (9-13/16") D
Weight	2.9 kg (6.4 lbs.) net 3.4 kg (7.5 lbs.) packed

* Design and specifications subject to changes without notice for improvements.

Sansui

SANSUI ELECTRIC CO., LTD.

1. BLOCK DIAGRAM

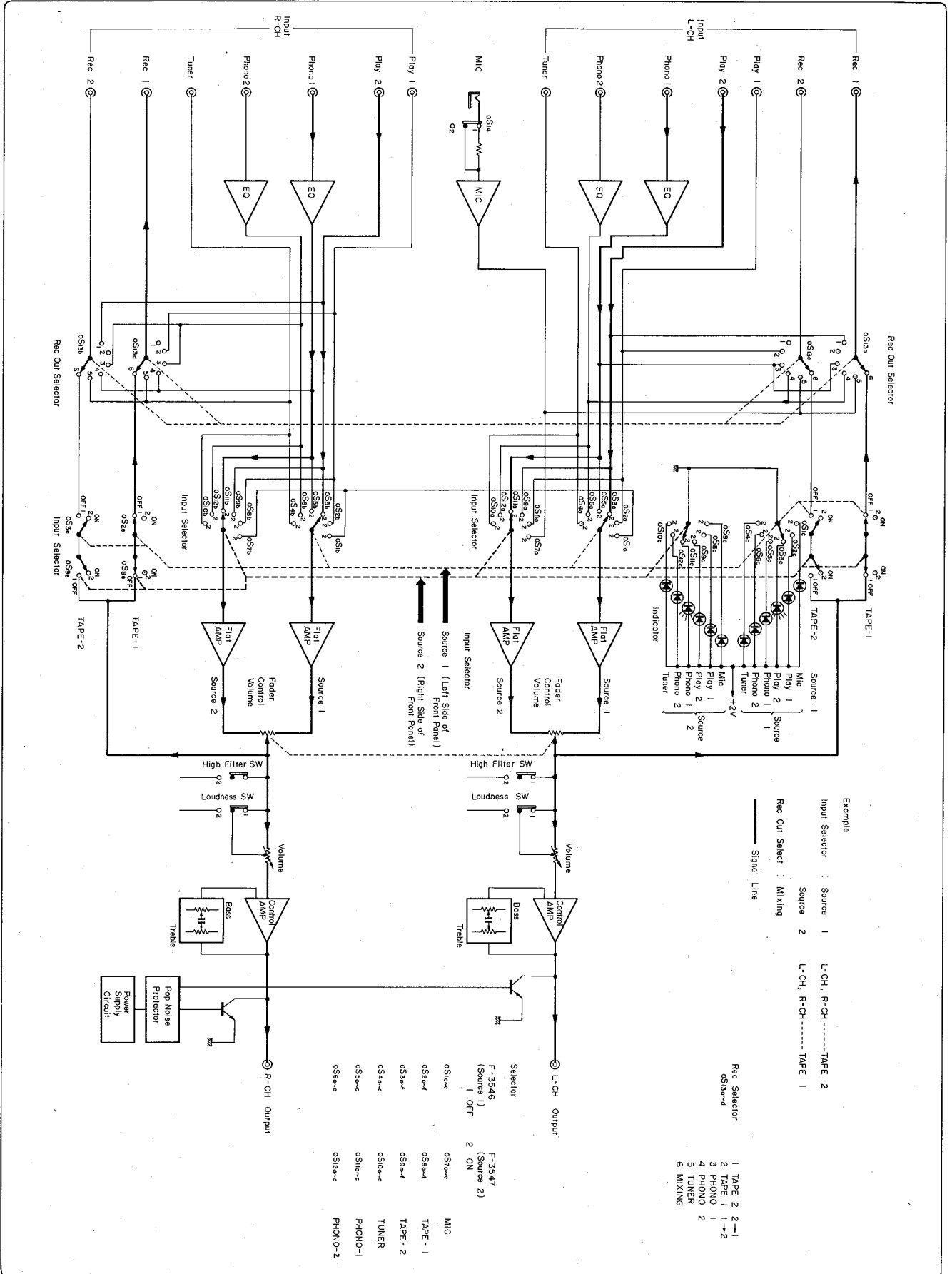

2. PARTS LOCATION & PARTS LIST

2-1. F-3546 Flat Control Amp. & Power Supply Circuit Board (Stock No. 00646401)

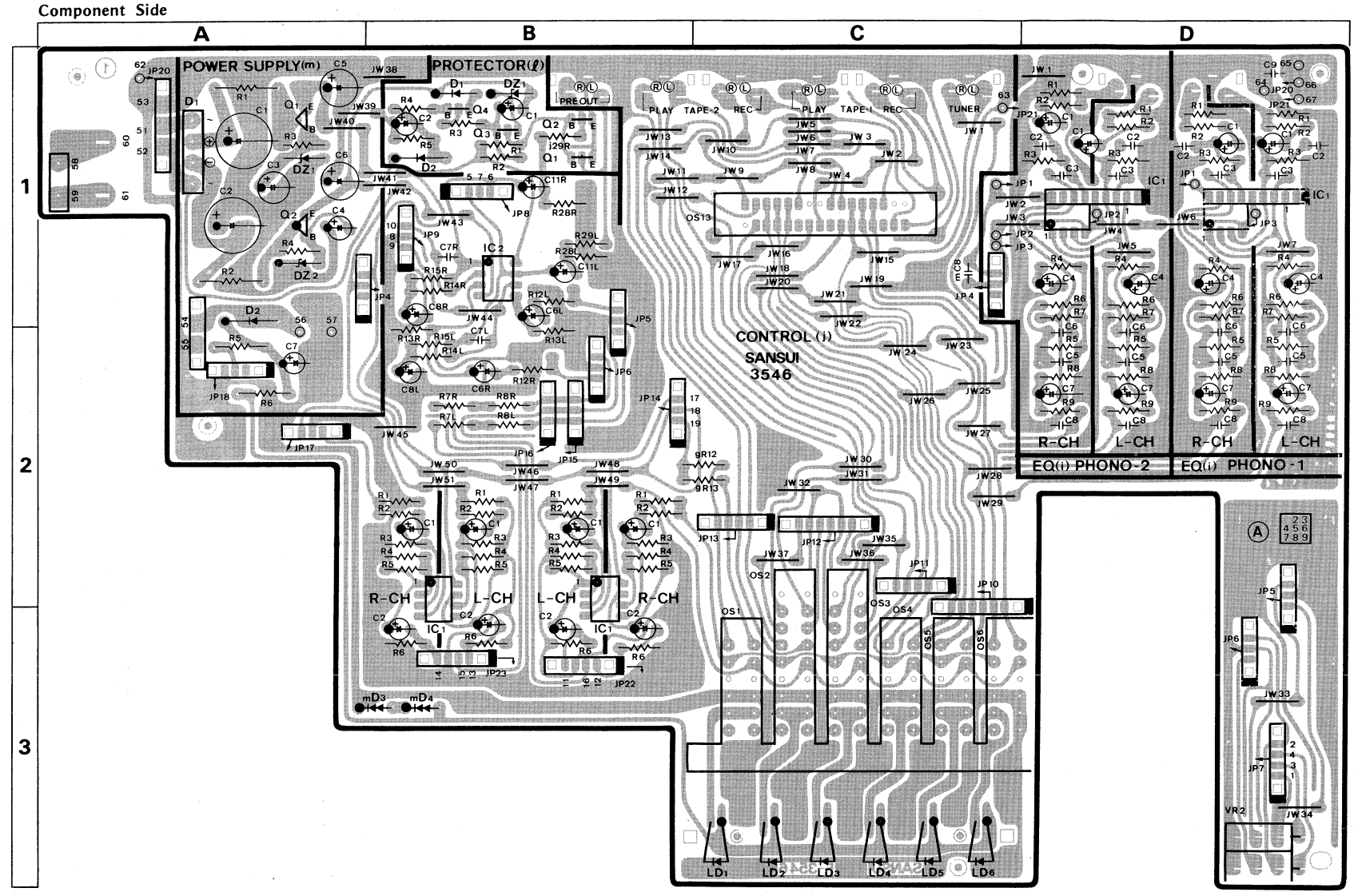

Parts List

Parts No.	Stock No.	Description
	07767700	6P LED Holder
●IC		
iiC1	46078900	M5218L
jiC1	03607700	NJM4558D
jiC2	03607700	NJM4558D
jVR2	07210000	100kΩ B Master Volume
●Transistor		
mQ1	03083902	2SD313AL-E
mQ2	03032302	2SB507V11AL-E
●Diode		
mD1	03117000	RB-152
mD2	03117700	10E-2
mDZ1	03179200	RD15E-B
mDZ2	03179200	RD15E-B
nLD1	07250900	LED TLG123

Parts No.	Stock No.	Description
nLD2	07250900	LED TLG123
nLD3	07250900	LED TLG123
nLD4	07250900	LED TLG123
nLD5	07250900	LED TLG123
nLD6	07250900	LED TLG123
oS1 ~ 6	46092600	Input Selector
oS13	07200200	Rec Selector Switch
	07249100	4P Terminal
●Transistor		
IQ1	07194800	2SC1815-Y
IQ2	07194800	2SC1815-Y
IQ3	07194800	2SC1815-Y
IQ4	07194800	2SC1815-Y
●Diode		
ID1	03117600	1S2473D
ID2	03117700	10E-2
IDZ1	03178200	RD9.1E-B

2-2. F-3549 MIC AMP Circuit Board (Stock No. 00646701)

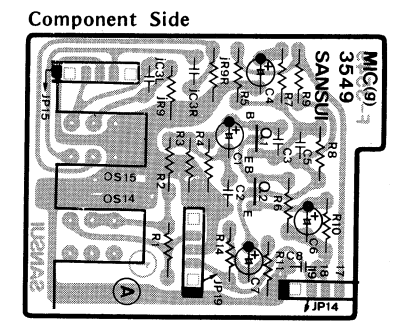

Parts List

Parts No.	Stock No.	Description
●Transistor		
gQ1	03010900	2SA992-F
gQ2	07225400	2SC2320L-F
oS14	46092500	MIC Switch

● Note: The circuit board, F-3547 & F-3548 are not supplied as the assembled. However, the individual parts on the circuit board are provided by orders.

2-3. F-3547 Input Indicator Circuit Board

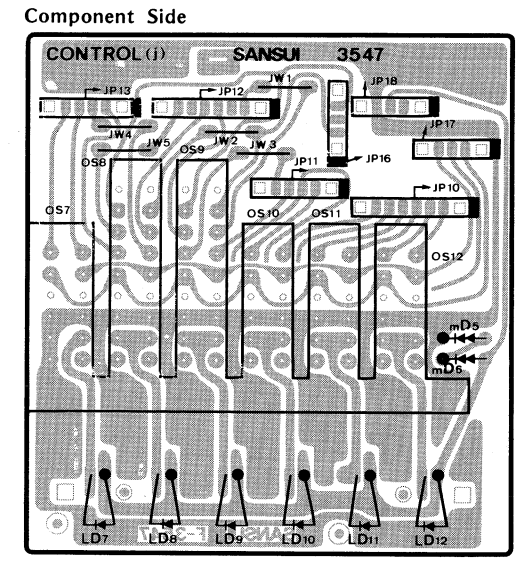

Parts List

Parts No.	Stock No.	Description
	07767700	6P LED Holder
●Indicator (LED)		
nLD7	07250800	TLO123
nLD8	07250800	TLO123
nLD9	07250800	TLO123
nLD10	07250800	TLO123
nLD11	07250800	TLO123
nLD12	07250800	TLO123
oS7 ~ 12	46092600	Selector Switch (Source 2)

2-4. F-3548 Control Circuit Board

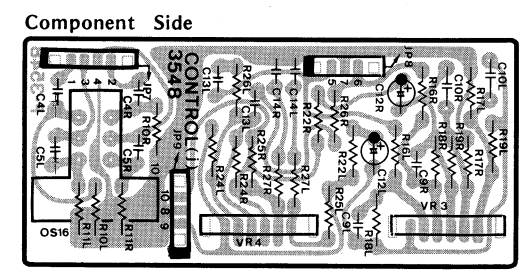

Parts List

Parts No.	Stock No.	Description
jVR3	46097300	50kΩ C, bass volume
jVR4	46097300	50kΩ C, treble volume
oS16	46092400	Loudness Switch

Abbreviations

C.R.	Carbon Resistor	E.L.	Low Leak Electrolytic Capacitor
S.R.	Solid Resistor	E.B.	Bi-Polar Electrolytic Capacitor
Ca.R.	Carbon Resistor	E.BL.	Low Leak Bi-Polar Electrolytic Capacitor
M.R.	Metal Film Resistor	F.C.	Film Capacitor
F.R.	Fusing Resistor	Ta.C.	Tantalum Capacitor
N.I.R.	Non-Inflammable Resistor	F.C.	Film Capacitor
C.C.	Ceramic Capacitor	M.P.	Metalized Paper Capacitor
C.T.	Ceramic Capacitor, Temperature Compensation	P.C.	Polystyrene Capacitor
E.C.	Electrolytic Capacitor	G.C.	Gimmick Capacitor

3. SCHEMATIC DIAGRAM

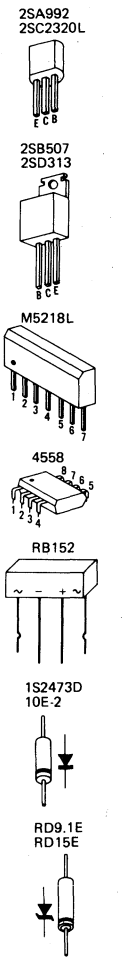
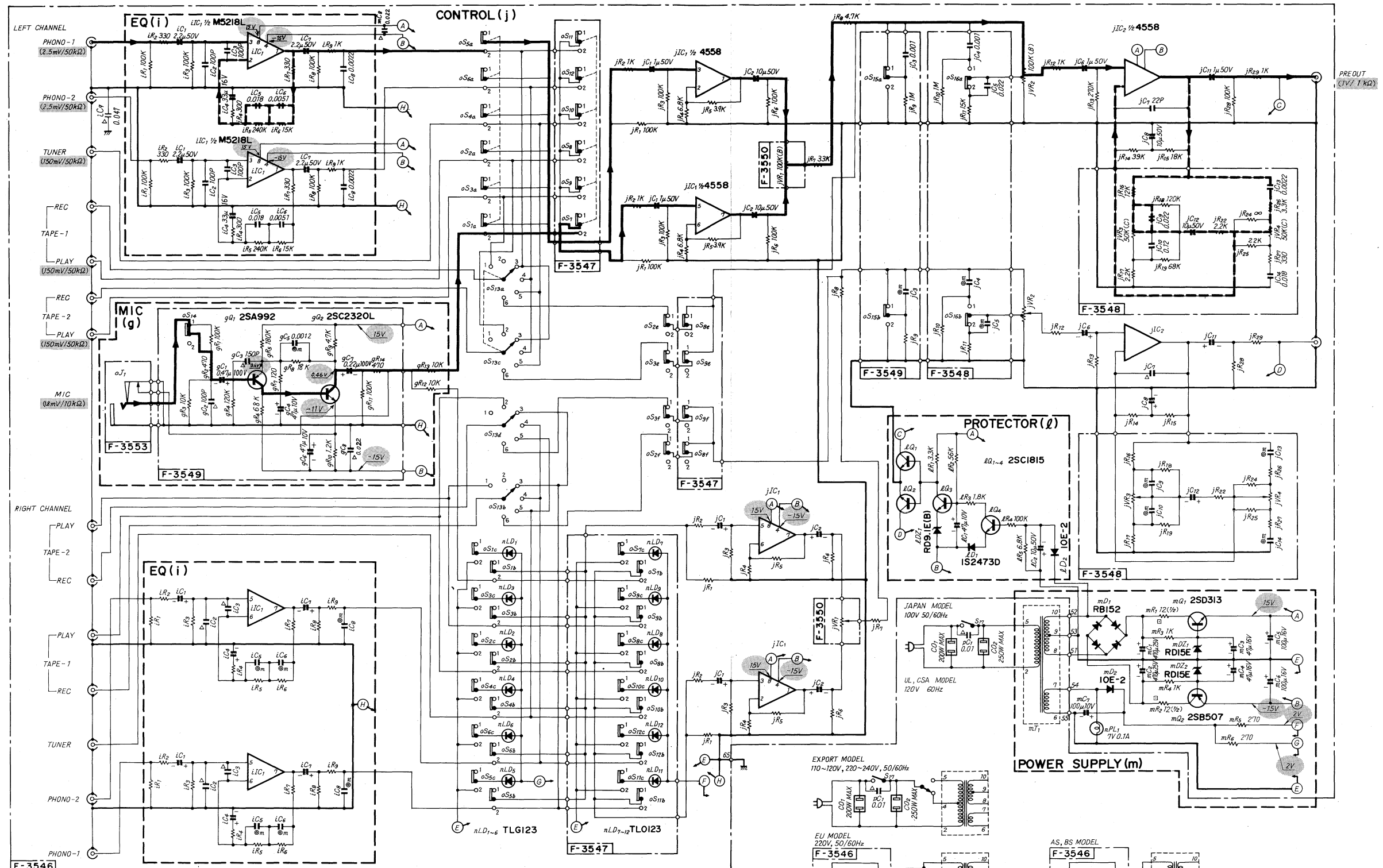

SYMBOL OF FUNCTION

(g) MIC
 (i) EQ
 (j) CONTROL
 (l) PROTECTOR
 (m) POWER SUPPLY
 (o) SELECTOR
 (n) INDICATOR

SELECTOR
 F-3546 F-3547
 oS1a-c oS7a-c MIC 1. OFF
 2. ON
 oS2a-f oS8a-f TAPE-1 1. OFF
 2. ON
 oS3a-f oS9a-f TAPE-2 1. OFF
 2. ON
 oS4a-c oS10a-c TUNER 1. OFF
 2. ON
 oS5a-c oS11a-c PHONO-1 1. OFF
 2. ON
 oS6a-c oS12a-c PHONO-2 1. OFF
 2. ON

REC SELECTOR
 F-3546
 oS13a-d 1. TAPE 2-1
 2. TAPE 1-2
 3. PHONO 1
 4. PHONO 2
 5. TUNER
 6. MIXING

F-3549
 oS14 MIC 1. MIC
 2. GUITAR

F-3548
 oS15 HIGH FILTER 1. OFF
 2. ON
 F-3548
 oS16 LOUDNESS 1. OFF
 2. ON

SYMBOL
 Δ Ceramic
 ● Mylar
 □ Non-Inflammable Resistor

RESISTORS
 Are in ohms, 1/4 Watt, ±5% Tolerance
 Unless Otherwise Noted K:KΩ, M:MΩ

Each D.C. Voltage shows the nominal value in volts at no input signal

OPTIONAL USE OF SEMICONDUCTOR

PARTS No.	TYPE No.
11C1	M5218L 4558BX 4562
gQ1	2SA992 2SA1016 2SA1049 2SA970
gQ2	2SC2320L 2SC2362 2N12459 2SC2240
1Q1 - 1Q4	2SC1815 2N5914 2SC145
1D1	1S2473D 1S1588 1S-1035

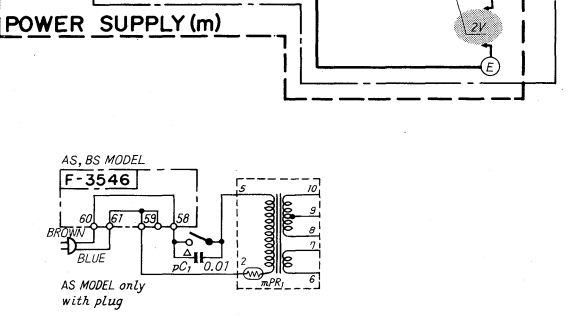
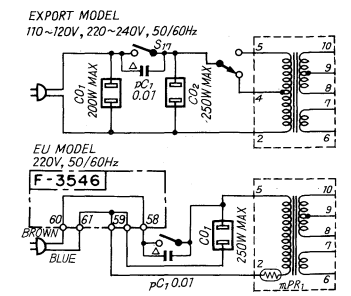

— Signal Line
 - - - N.F.B. Loop Line

4. OTHER PARTS

4-1. Front View

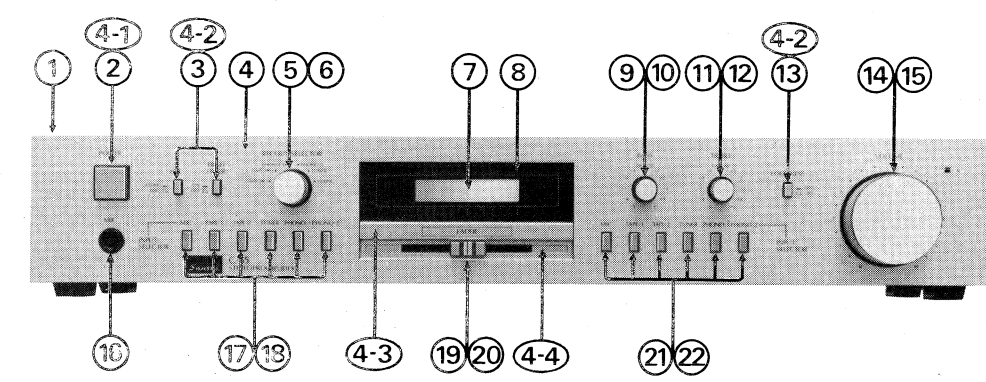

4-2. Top View

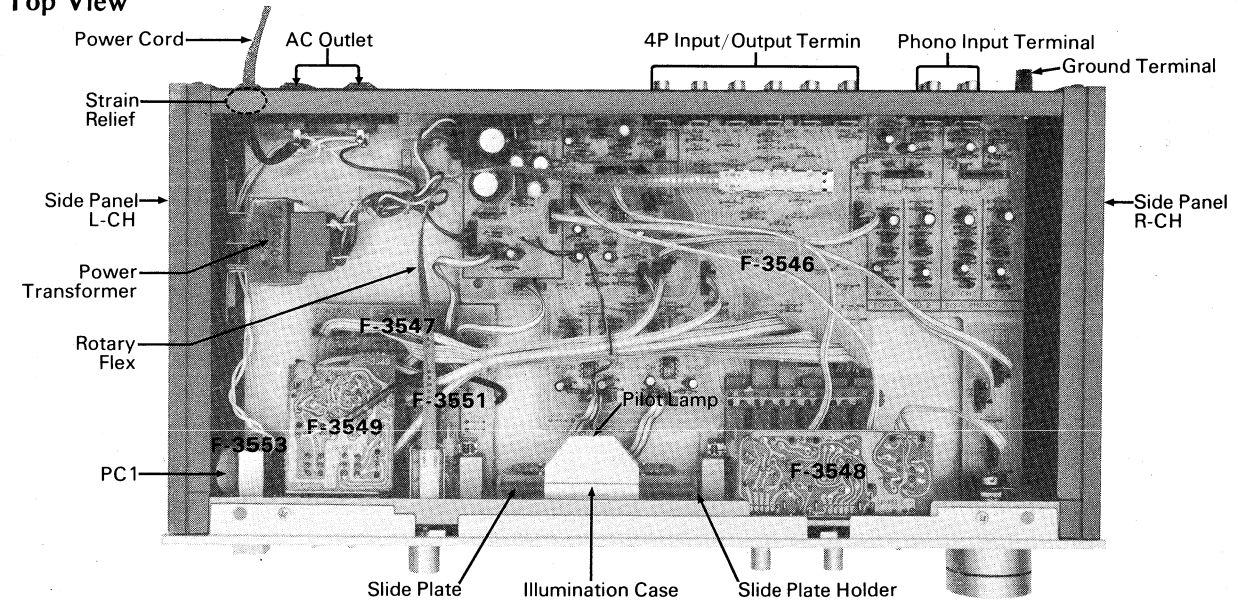

Parts List <Front View>

Parts No.	Stock No.	Description
1	07591000	Bonnet
2	46087300	Power Switch
3	46092500	MIC/High Filter Switch
4	07772500	Front Panel Ass'y
4-1	53195000	Push Switch Knob, power
4-2	07522500	Push Switch Knob, mic, high filter, loudness
4-3	07767900	Slide Volume Guide
4-4	07772900	Masking Sheet
5	46092200	Rec Out Selector
6	07592500	Knob, rec selector switch
7	07593200	Plastic Lens
8	07768000	Fader Window
9	46097300	Bass Volume
10	07776200	Knob, bass volume
11	46097300	Treble Volume
12	07776200	Knob, treble volume
13	46092400	Loudness Switch
14	07210000	Volume, 100kΩ B
15	07592600	Knob, volume, L-CH
	07592700	Knob, volume, R-CH
16	07219700	MIC Jack
17	46092600	Input Selector Switch, L-CH
18	07760000	Knob, input selector switch
19	46095300	Fader Volume, 100kΩ B

Parts No.	Stock No.	Description
20	07777700	Knob, fader volume
21	46092600	Input Selector Switch, R-CH
22	07760000	Knob, input selector switch

Parts List <Top View>

Parts No.	Stock No.	Description
	15003901	Power Transformer
	07766350	Side Panel, L-CH
	07763600	Side Panel, R-CH
	38004700	Power Cord
	39106000	Strain Relief
	07189600	AC Outlet
	46092300	Rotary Flex
	07249100	4P Input/Output Terminal
	07249100	Phono Input Terminal
	22301500	Ground Terminal
pC1	08302200	10000pF 125V C.C.
nPL1	04004500	Pilot Lamp 7V, 100mA
	07593000	Illumination Case
	07768300	Slide Plate
	07768400	Slide Plate Holder

5. PACKING LIST

Parts No.	Stock No.	Description
1	07599500	Vinyl Cover
2	07585700	Styrofoam Packing
3	07775600	Carton Case

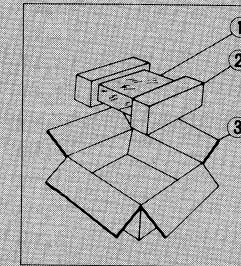

6. ACCESSORY LIST

Stock No.	Description
46093200	Operating Instruction
38103200	PJP Cord

SANSUI ELECTRIC COMPANY LTD.: 14-1, Izumi 2-chome, Suginami-ku, Tokyo 168 Japan PHONE:(03) 323-1111/TELEX:232-2076
 SANSUI ELECTRONICS CORPORATION: 1250 Valley Brook Ave. Lyndhurst, N.J. 07071 U.S.A.
 333 West Alondra Blvd. Gardena, California 90247 U.S.A.
 3036 Koapaka St. Honolulu, Hawaii 96819 U.S.A.
 SANSUI ELECTRONICS (U.K.) LTD.: Unit 10A, Lyon Industrial Estate, Rockware Avenue, Greenford, Middx UB6, OAA, England
 SANSUI ELECTRONICS G.M.B.H.: Arabella center, 6 Frankfurt AM Main, Lyoner Strasse 44-48, West Germany