

SERVICE MANUAL

AM/FM STEREO RECEIVER SANSUI G-2000/3000



SPECIFICATIONS

G-2000

Audio section	
Power output	
Min. RMS, both channels driven, from 20 to 20,000Hz, with no more than 0.2% total harmonic distortion.	
16 watts per channel into 8 ohms	
16 watts per channel into 4 ohms	
Load impedance	4 and 8 ohms
Total harmonic distortion	less than 0.2% at or below rated min. RMS power output
Intermodulation distortion (70Hz: 7 kHz = 4:1 SMPTE method)	less than 0.2%
Frequency response (at 1 watt)	10 to 50,000Hz ± 1 dB -2 dB
RIAA curve deviation (PHONO)	$+0.5$ dB -0.5 dB (30 to 15,000Hz)
Damping factor	approximately 30 at 8 ohms load
Input sensitivity and impedance (1 kHz, for rated power output)	
PHONO	2.5 mV/47 kilohms (Max. input capability; 200mV at 1 kHz, less than 0.5% total harmonic distortion)
AUX, TAPE	150 mV/47 kilohms
Output level (1 kHz)	
TAPE REC (pin jack)	150 mV/47 kilohms (DIN)
	43 mV
Channel separation (1 kHz, at rated power output)	
PHONO	better than 50 dB
AUX	better than 50 dB
Hum and noise (short-circuit, A network)	
PHONO	75 dB
AUX	90 dB
Controls	
BASS	± 10 dB (50 Hz)
TREBLE	± 10 dB (10 kHz)
LOUDNESS (-30 dB)	7 dB at 50 Hz 5 dB at 10 kHz

FM section

Tuning range	88 to 108 MHz
Usable sensitivity	
Mono IHF	11.0 dBf (1.95 μ V)
DIN	1.2 μ V
Stereo IHF	19.0 dBf
50 dB Quieting sensitivity	
Mono	18 dBf
Stereo	39 dBf
Signal to noise ratio (at 65 dBf)	
Mono	70 dB
Stereo	67 dB
Distortion (at 65 dBf)	
Mono	less than 0.2% at 100 Hz less than 0.18% at 1,000 Hz less than 0.3% at 6,000 Hz
Stereo	less than 0.3% at 100 Hz less than 0.25% at 1,000 Hz less than 0.4% at 6,000 Hz
Alternate channel selectivity (at 400 kHz)	50 dB
Capture ratio	1.5 dB
Image response ratio	48 dB (at 98 MHz)
Spurious response ratio	70 dB (at 98 MHz)
Stereo separation	30 dB at 100 Hz 40 dB at 1,000 Hz 28 dB at 10,000 Hz
Frequency response	30 to 15,000 Hz $+0.5$ dB -2 dB
Antenna input impedance	300 ohms balanced 75 ohms unbalanced
AM section	
Tuning range	530 to 1,600 kHz
Usable sensitivity (Bar antenna)	50 dB/m (300 μ V/m)
Selectivity	35 dB
Signal to noise ratio	46 dB
Power requirements	
Power voltage	100, 120, 220, 240V (50/60 Hz) 120V (Usable 110 ~ 130V) 60 Hz (for U.S.A. and Canada only)
Power consumption	
Rated consumption	90 watts 100 VA

Dimensions	433 mm (17-1/16") W 153 mm (6-1/16") H 352 mm (13-7/8") D
Weight	7.3 kg (16.1 lbs) net 8.7 kg (19.2 lbs) packed

Sansui

SANSUI ELECTRIC CO., LTD.

SPECIFICATIONS

G-3000

Audio section

Power output

Min. RMS, both channels driven, from 20 to 20,000Hz, with no more than 0.15% total harmonic distortion.

26 watts per channel into 8 ohms

26 watts per channel into 4 ohms

Load impedance 4 and 8 ohms

Total harmonic distortion

less than 0.15% at or below rated min. RMS power output

Intermodulation distortion (70Hz: 7kHz = 4:1 SMPTE method) less than 0.15%

Frequency response (at 1 watt)

10 to 50,000Hz +1 dB -2dB

RIAA curve deviation (PHONO)

+0.5 dB -0.5 dB (30 to 15,000Hz)

Damping factor approximately 30 at 8 ohms load

Input sensitivity and impedance (1 kHz, for rated power output)

PHONO 2.5mV/47 kilohms

(Max. input capability; 200mV at 1kHz, less than 0.5% total harmonic distortion)

AUX, TAPE 150mV/47 kilohms

Output level (1kHz)

TAPE REC (pin jack) 150mV/47 kilohms (DIN) 43mV

Channel separation (1kHz, at rated power output)

PHONO better than 50dB

AUX better than 50dB

Hum and noise (short-circuit, A network)

PHONO 75 dB

AUX 90dB

Controls

BASS ±10dB (50Hz)

TREBLE ±10dB (10kHz)

LOUDNESS (-30dB) 7 dB at 50Hz

. 5 dB at 10kHz

FM section

Tuning range 88 to 108MHz

Usable sensitivity

Mono IHF 11.0dBf (1.95 μV)

DIN 1.2 μV

Stereo IHF 19.0dBf

50dB Quieting sensitivity

Mono 18dBf

Stereo 39dBf

Signal to noise ratio (at 65dBf)

Mono 70dB

Stereo 67dB

Distortion (at 65dBf)

Mono less than 0.2% at 100Hz

less than 0.18% at 1,000Hz

less than 0.3% at 6,000Hz

less than 0.3% at 100Hz

less than 0.25% at 1,000Hz

less than 0.4% at 6,000Hz

Alternate channel selectivity (at 400kHz)

. 50dB

Capture ratio 1.5dB

Image response ratio 48 dB (at 98MHz)

Spurious response ratio 70dB (at 98MHz)

Stereo separation 30dB at 100Hz

40dB at 1,000Hz

28dB at 10,000Hz

Frequency response 30 to 15,000Hz +0.5 dB -2dB

Antenna input impedance

300 ohms balanced

75 ohms unbalanced

AM section

Tuning range 530 to 1,600kHz

Usable sensitivity (Bar antenna)

50dB/m (300 μV/m)

Selectivity 35dB

Signal to noise ratio 46dB

Power requirements

Power voltage 100, 120, 220, 240V (50/60Hz)

120V (Usable 110 ~ 130V)

60Hz

(for U.S.A. and Canada only)

Power consumption

Rated consumption 120 watts 140 VA

Dimensions 433mm (17-1/16") W

153mm (6-1/16") H

352mm (13-7/8") D

Weight 8 kg (17.6 lbs) net

9.4 kg (20.7 lbs) packed

* Design and specifications subject to change without notice for improvements.

1. OPERATIONS

Pop-noise preventive circuit

In order to prevent the annoying pop-noise to the loudspeakers at turning the power of the amplifier ON, the pop-noise preventive circuit adopted in the G-3000 is the combination of the conventional driver-voltage delay type used in the power supply (rectifier) circuit and the NF delay type pop-noise preventive circuits. The configuration of NF delay type pop-noise preventive circuit is shown in Fig. 1.

In this circuit, the switching (ON-OFF) of the transistor TR05 is made by the time constant of the capacitor C40 and resistor R88. Thereby the NF resistor, R51 is controlled, and the gain of the main amplifier stage is lowered when TR05 is ON, thus the voltage drift (transient voltage) of the main amplifier at turning the power ON does not appear on the speaker terminals for very short period of time. In other words, at the instant that the power is turned ON, the voltage at the point A rises up to +13V, then the voltage decreases by means of the time constant of C40 and R88 as shown in Fig. 2. At this time, the diode D11 is inversely biased, consequently, the potential voltage of the point B is 0V as Fig. 3. Because of this, TR05 turns to the cut-off, thus the NF resistor, R51 acquires such a state as its resistance value becomes equivalently very large, which decreases the gain of the power amplifier. When the charge of the C40 is completed, the voltage of the point B (see Fig. 3) becomes negative, as a result, the diode D11 is biased. Therefore, TR05 is turned ON, and the circuit of this equipment is normally operated approximately 2 seconds after the power is turned ON to prevent the pop-noise which flows to loudspeakers.

Fig. 1

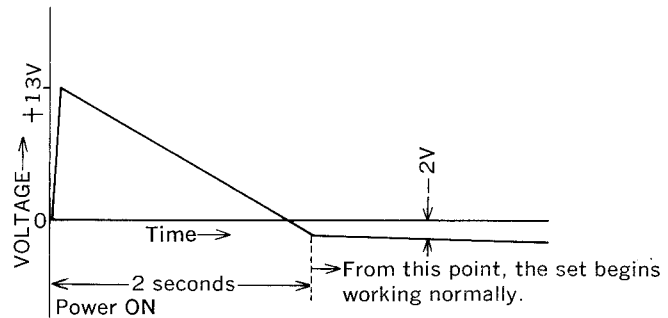
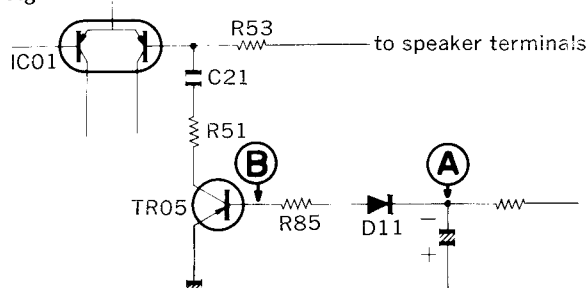

Fig. 2 Voltage variation during a certain period of time at ①

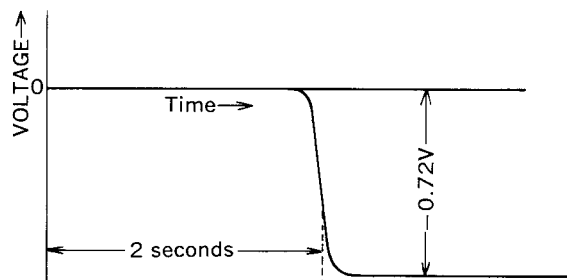
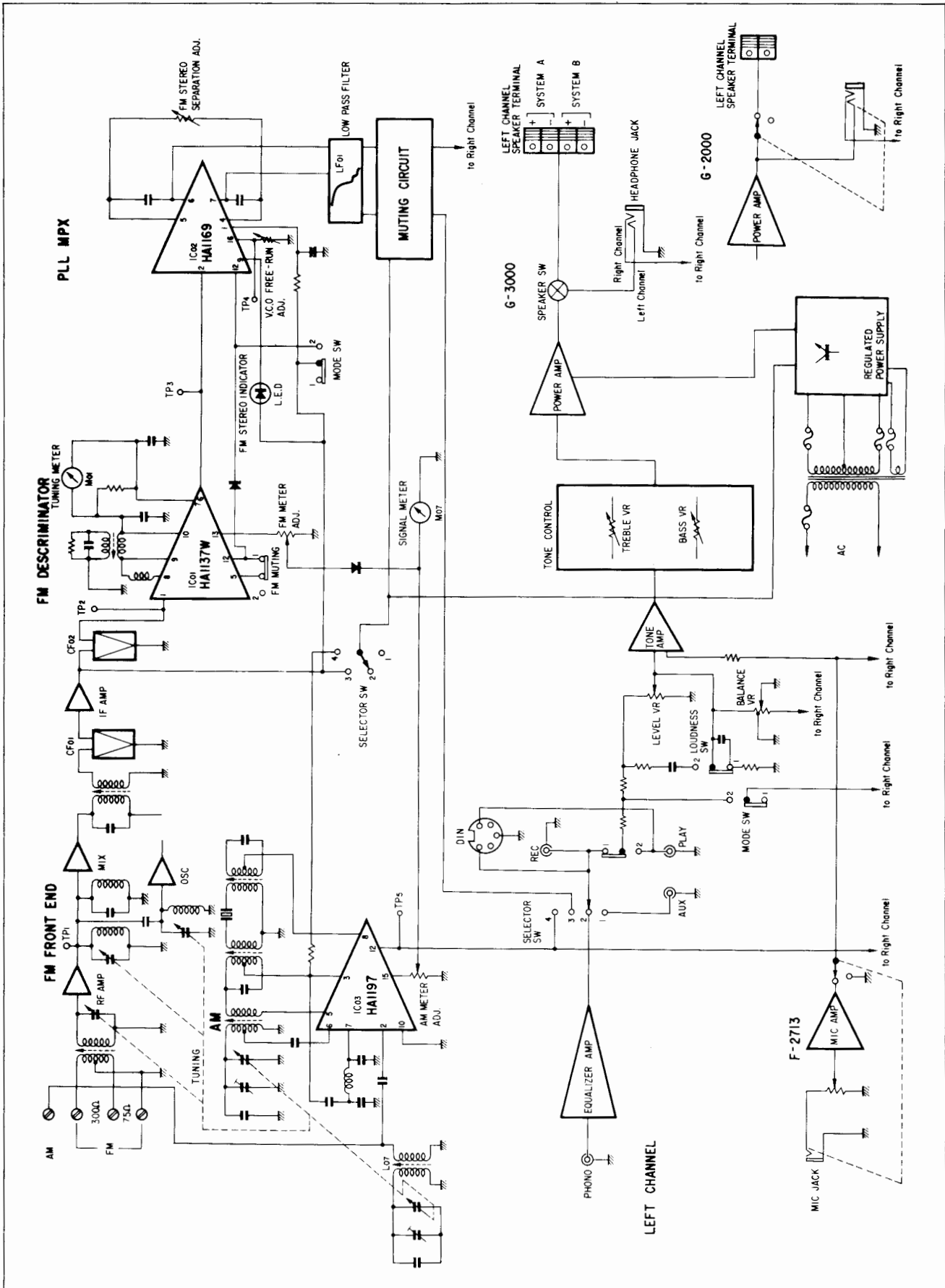

Fig. 3 Voltage variation at ②

2. BLOCK DIAGRAM



3. ADJUSTMENTS

* Refer to the picture of top view indicating test points on page 4.

1) FM Adjustment

- Note: 1. Selector FM AUTO
 2. FM Muting Switch OFF
 3. Connection . . Connect the output of genescope to TP through 100pF ceramic capacitor.

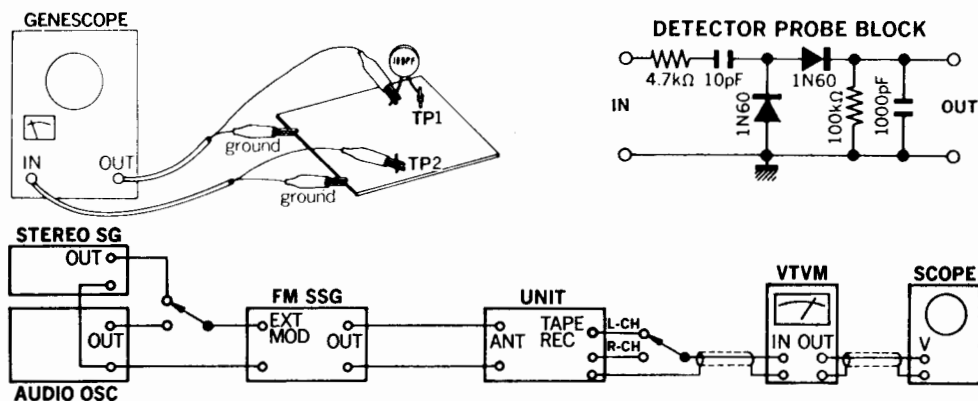

(1) FM IF Adjustment & Dial Calibration

STEP	SUBJECT	FEED SIGNAL		MEASURE OUTPUT	ADJUST	ADJUST FOR	REMARKS
		FROM	TO				
1.	IF Coil	Output 80dB Genescope	TP1 F-2707	TP2 F-2707 Use Detector Probe	T01 F-2707	Max. IF waveform	
2.	Discriminator Coil	Same as above	Same as above	TP3 F-2707	T02, T03 F-2707	Steep linearity of S curve Make symmetrical S curve	
3.	Tuning Meter	98MHz ANT Input 65dBf (59.8dB) 1000Hz (100% MOD) FM SSG	ANT terminal 300Ω	Tuning Meter	T02 F-2707	Center on Meter	
4.	90MHz Dial Calibration	90MHz ANT Input 65dBf (59.8dB) 1000Hz (100% MOD) FM SSG	Same as above	REC terminal VTVM & Scope	L03 F-2707	Max. indication on Signal meter & Center indication on Tuning meter	
	106MHz Dial Calibration	106MHz ANT Input 65dBf (59.8dB) 1000Hz (100% MOD) FM SSG	Same as above	Same as above	TC03 F-2707		
5.	90MHz RF Adj.	90MHz ANT Input Minimum value with sine wave 1000Hz (100% MOD) FM SSG	Same as above	Same as above	L01, L02 F-2707	Same as above	
	106MHz RF Adj.	106MHz ANT Input Minimum value with sine wave 1000Hz (100% MOD) FM SSG	Same as above	Same as above	TC01, TC02 F-2707	Same as above	
6.	Signal Meter Volume	98MHz ANT Input 65dBf (59.8dB) 1000Hz (100% MOD) FM SSG	Same as above	Signal Meter	VR03 F-2707	4.3 on Meter	

(2) FM STEREO Adjustment

STEP	SUBJECT	FEED SIGNAL		MEASURE OUTPUT	ADJUST	ADJUST FOR	REMARKS
		FROM	TO				
1.	PLL VCO Adj.	98MHz ANT Input 65dBf (59.8dB) FM SSG Pilot 19kHz (9% MOD) SUB 1 kHz + Pilot (100% MOD) STEREO SG	ANT terminal 300Ω	Stereo indicator	VR01 F-2707	Light indicator	Adjust the VR01 within center of lighting level.
	PLL VCO Adj. In case of using Freq. counter.	98MHz ANT Input 65dB (59.8dB) FM SSG	Same as above	TP4 F-2707 Use Freq. counter	VR01 F-2707	76 kHz ±150Hz	
2.	Separation	98MHz ANT Input 65dBf (59.8dB) FM SSG Pilot 19kHz (9% MOD) R (or L) Mode 1 kHz + Pilot (100% MOD) STEREO SG	Same as above	REC terminal R-CH → L-CH VTVM & Scope	VR02 F-2707	Set 34dB	Confirm separation L-CH → R-CH (34dB)

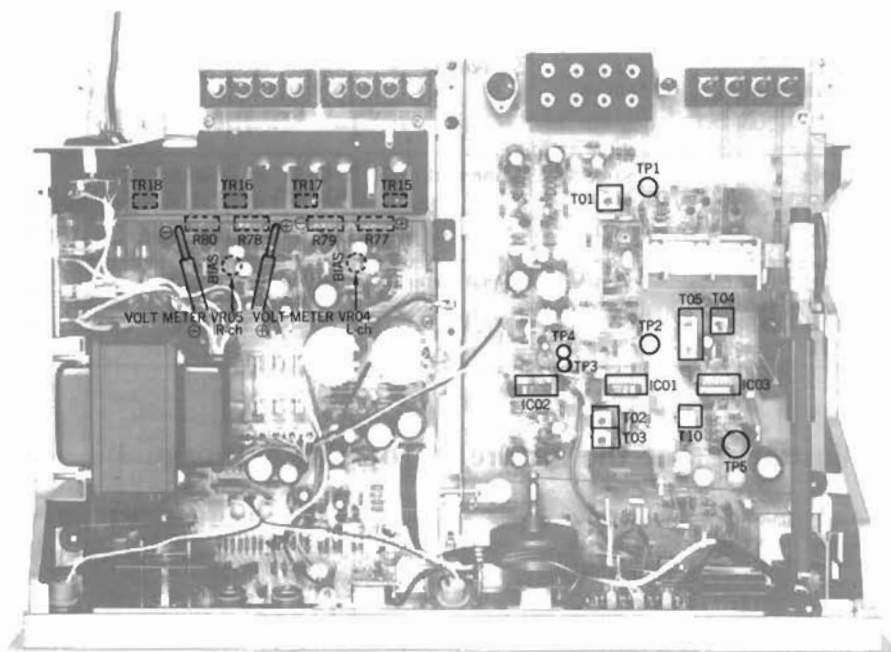

〈Top View〉

※ NEW MEASUREMENT FOR FM

Input signal level under the provision of IHFM-T-200, a new measurement method is indicated by available power ratio "dBf". To obtain approximate available power ratio "dBf", abstract 0.8 from attenuator indication of general FMSSG (open load indication type); however, the conventional measurement, IHFM-T-100 is designated together too.

The way of modulation on IHFM-T-200 is shown below.

	modulation frequency	modulation mode	modulation factor
FM MONO	1000Hz		100%
FM STEREO	1000Hz	SUB	Pilot 9% Pilot + SUB 100%

※The relation between the standard input 65 dBf of IHFM-T-200 and the former indication "dB" is shown in below.

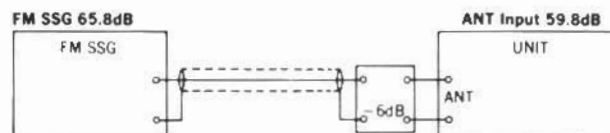

2) AM IF Adjustment & Dial Calibration

- Note: 1. Selector AM
 2. Confirm start point of dial pointer before alignment.

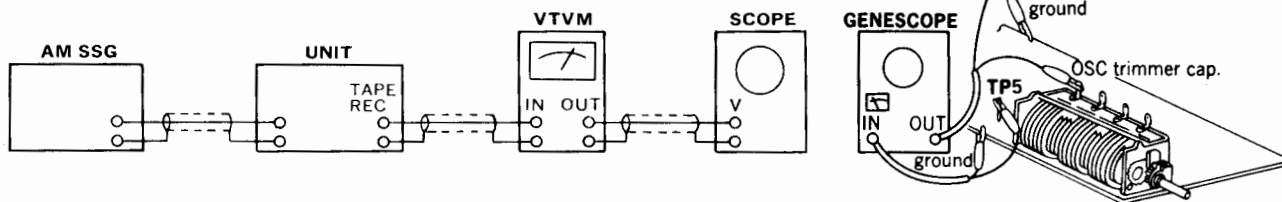

STEP	SUBJECT	FEED SIGNAL		MEASURE OUTPUT	ADJUST	ADJUST FOR	REMARKS
		FROM	TO				
1.	IF Coil	Genescope Output level 70dB	TC05 F-2707	TP5 F-2707	T05 L10 F-2707	Max. IF waveform	
2.	600kHz Dial Calibration	600 kHz ANT Input 60dB 400 Hz (MOD 30%) AM SSG	AM ANT terminal	REC terminal L or R-CH VTVM & Scope	T04 F-2707	Max. indication on signal meter	
	1400 kHz Dial Calibration	1400 kHz ANT Input 60dB 400 Hz (MOD 30%) AM SSG	Same as above	Same as above	TC04 F-2707	Same as above	
3.	600 kHz RF Adj.	600 kHz ANT Input 50dB 400 Hz (MOD 30%) AM SSG	Same as above	Same as above	Bar Antenna L07	Same as above	
	1400 Hz RF Adj.	1400 kHz ANT Input 50dB 400 Hz (MOD 30%) AM SSG	Same as above	Same as above	TC05 F-2707	Same as above	
4.	Signal Meter volume	1000 kHz ANT Input 80dB 400 Hz (MOD 30%) AM SSG	Same as above	Signal Meter	VR04 F-2707	4.5 on meter	

3) Bias Current Adjustment (See the Picture of Top View on page 4)

1. Confirm AC power supply voltage (100V, 117V, 220V or 240V).
2. Level Volume Minimum
3. Room Temperature 18°C ~ 28°C (65°F ~ 83°F)
4. Before this adjustment, turn bias adjustment volumes of VR04 and VR05 fully counterclockwise, then run this unit for more than three minutes.

Note: For this adjustment, put the lead + (plus) side of volt meter and + (plus) side of R77 (& R78) and the lead - (minus) side to - (minus) side of R79 (& R80) on both channels.
 L-ch R77, R79
 R-ch R78, R80

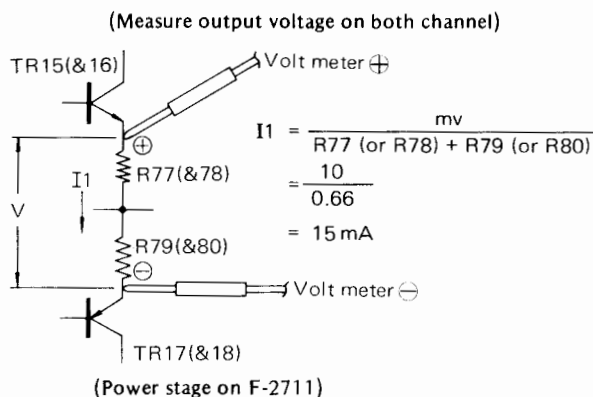

STEP	SUBJECT	EQUIPMENT	MEASURE OUTPUT	ADJUST	ADJUST FOR
1	Bias Current L-CH	DC Volt meter	* See above	VR04 F-2711	10 mV ±1 mV (15 mA)
2	Bias Current R-CH	DC Volt meter	* See above	VR05 F-2711	10 mV ±1 mV (15 mA)

4. PARTS LOCATION & PARTS LIST

1) F-2707 AM/FM Tuner & FM MPX Circuit Board

Conductor Side

(Stock No. 7521551, G-2000)(Stock No. 7521521, G-3000)

Since some of capacitors and resistors are omitted from parts lists in this Service Manual, refer to the Common Parts List for capacitors & resistors which was appended previously to each Sansui Manual.

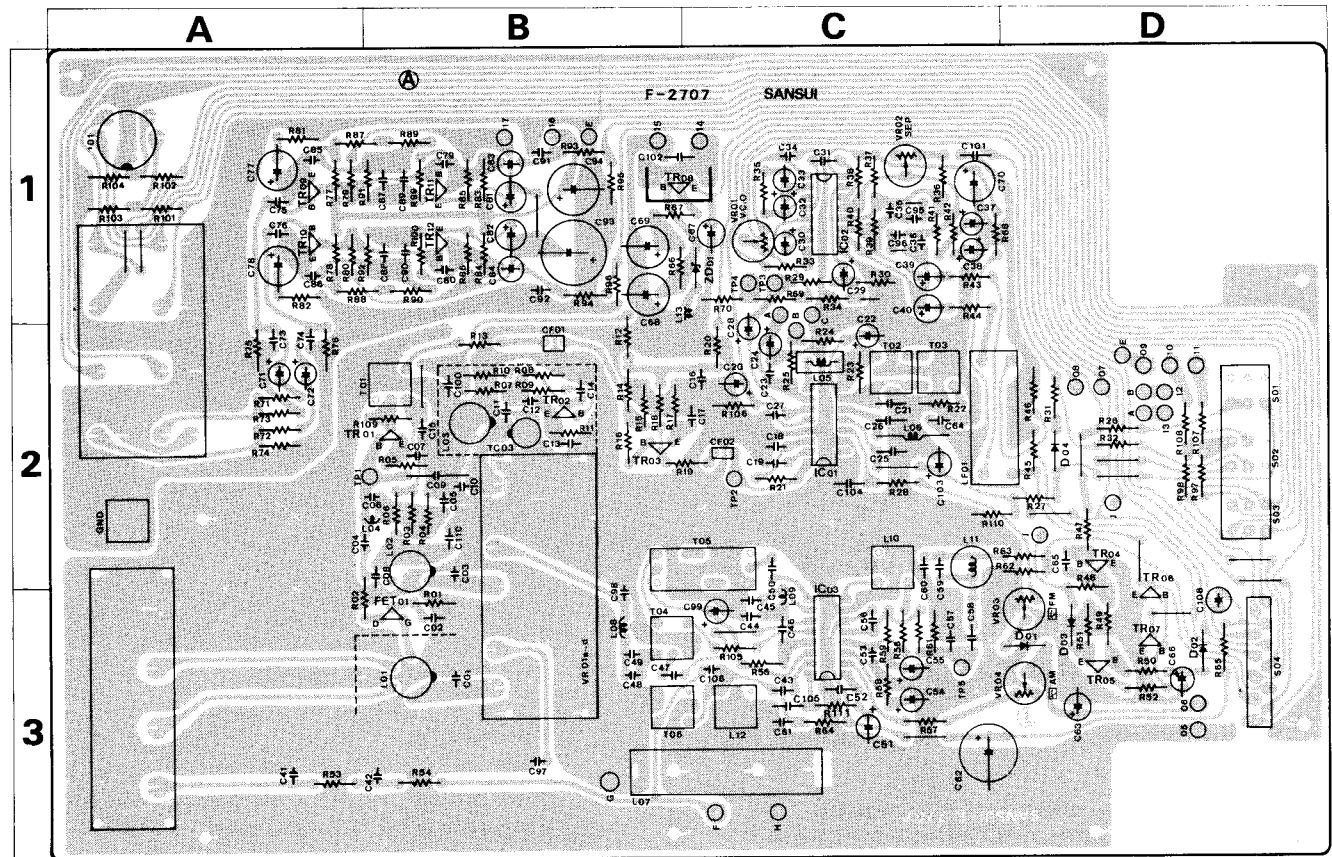

Parts List

Parts No.	Stock No.	Description	Position	Parts No.	Stock No.	Description	Position
TR01, 02	0305801, 2	2SC1047 (B, C)	2B	L 03	4220400	O.S.C. Coil	2B
TR03	0306341, 2	2SC1674 (L, K)	2B	L 04	4900140	1 μ H } Inductor Coil	2C
TR04	0305951, 2	2SC945 (Q, P)	2D	L 05	4290300	18 μ H } Inductor Coil	
TR05	0300470	2SA726W (F)	3D	L 06	4290011	Peaking Coil 3.5 μ H	3C
TR06, 07	0306390	2SC1636-1	3D	L 07	4200750	Antenna Coil (AM)	
TR08	0308450, 1	2SD356 (C, D)	1B, C	L 08	4900140	1 μ H Inductor Coil	3B
TR09, 10	0300900, 1	2SA906 (G, H)	1A	L 09	4900110	100 μ H Inductor Coil	2C
TR11, 12	0306070, 1	2SC1313 (F, G)	2A	L 10	4230620	1F Coil (AM)	
IC 01	0360350	HA1137W	2C	L 11	4900060	22mH Inductor	2C
IC 02	0360320	HA1196	1C	T 01	4235930	1F Coil (FM)	2B
IC 03	0360390	HA1197	3C	T 02	4235990, 1	1F Coil	2C
FT01	0370172	2SK49 (H) FET		T 03	4236000, 1	1F Coil	2C
D 01 ~ 04	0311160	1S2473D Diode	2,3D	T 04	4220650	OSC Coil (AM)	3B
ZD01	0315970	EQA01-13R Zener Diode	1C	T 05	0910370	Ceramic Filter (AM)	2C
C 01, 03	0669347	12pF 50V C.C.	3B, 2B	CF01, 02	0910380	Ceramic Filter (FM)	1C
C 04	0669210	10pF 50V C.C.	2A	LF01	0910220	Low Pass Filter	
C 06	0669503	3pF 50V C.C.	2B	VR01	1034250	4.7 k Ω (B) VCO Free-Run	1C
C 09	0679012	1.5pF 500V Gimmick Capacitor	2B	VR02	1035210	220 k Ω (B) Stereo Separation	
C 10	0669019	18pF 50V C.C.	2B	VR03	1035150	22k Ω (B) FM Meter	3D
C 11, 12	0669320	10pF 50V C.C.	2B	VR04	1035110	4.7k Ω (B) AM Meter	3D
C 13	0669345	10pF 50V C.C.	2B	S 01	1131060, 1	Push Switch, FM muting	
C 32	0573159	1.5 μ F 35WV T.C.	1C	S 02	1101840	Rotary Switch, selector	2D
C 33	0573339	3.3 μ F 35WV T.C.	1C	VC01	1220210	AM FM Variable Capacitor	2,3B
C 34	0629005	360pF 50V P.C.	1C	TC03	1230090	Trimmer Capacitor	1C
C 48	0669400	15pF 50V C.C.	3B	J 01	2090030	5P DIN Socket	
C 49	0620361	360pF 50V P.C.	3B		2210330	4P Antenna Terminal	3B
C 89, 90	0620161	160pF 50V P.C.	1B		2230180	Ground Terminal	
C 95, 96	0620561	560pF 50V P.C.	1C		2200410, 1	8P Input Terminal	
C 97	0669563	3pF 50V C.C.	3B				
C 98	0669400	15pF 50V C.C.	3B				
L 01	4200720	Antenna Coil (FM)	3B				
L 02	4210340	RF Coil	2B				

2) F-2711 Pre/Main & Power Supply Circuit Board (Stock No. 7571781, G-2000) (Stock No. 7571771, G-3000)

Conductor Side

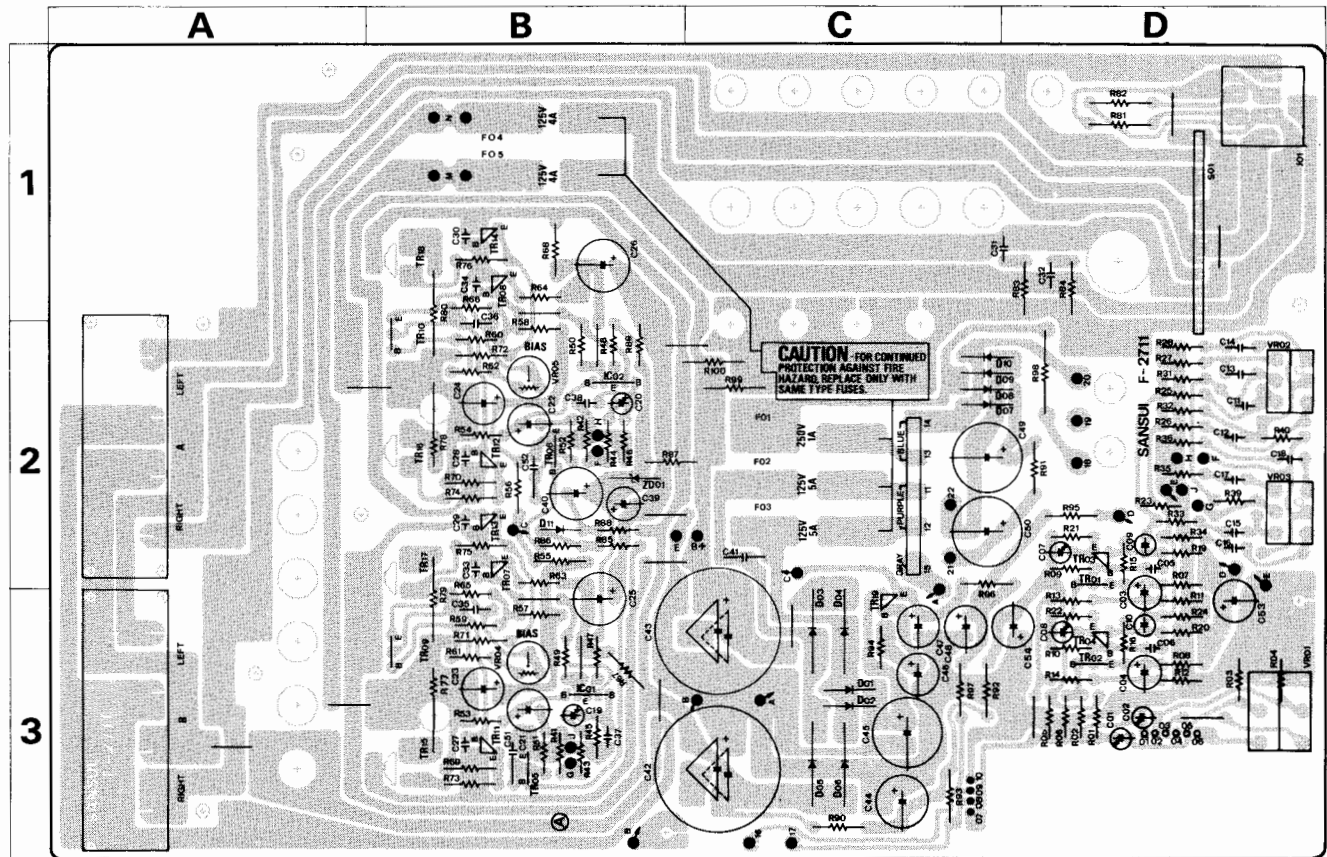

Parts List

Parts No.	Stock No.	Description	Position	Parts No.	Stock No.	Description	Position	
TR01,02	0300470, 1	2SA726W (F, G)	Transistor	R 87	0210272	2.7 kΩ ½W N.I.R. (G-2000)	2B	
TR03,04	0306070, 1	2SC1313 (F, G)		2D,3D	R 90	0210221	1.2 kΩ ½W N.I.R. (G-3000)	3C
TR05,06	0300510, 1	2SA733 (P, Q) (G-3000)		3B,2B		0210271	270Ω ½W N.I.R. (G-3000)	
TR07,08	0306371, 2	2SC1175 (E, F) (G-2000)		2B,1B	R 91	0192220	22Ω ½W F.R.	2D
	0306521, 2	2SC1439 (B, V) (G-3000)			R 92	0210471	470Ω ½W N.I.R. (G-2000)	3C
TR09,10	0305951, 2	2SC945 (P, Q)		3B,2B		0210681	680Ω ½W N.I.R. (G-3000)	
TR11,12	0305930, 1	2SC1211 (C, D) (G-2000)		3B,2B	R 93	0210121	120Ω ½W N.I.R. (G-2000)	3C
	0308521, 2	2SD438 (E, F) (G-3000)				0210331	330Ω ½W N.I.R. (G-3000)	
TR13,14	0300310, 1	2SA697 (C, D) (G-2000)		2B,1B	R 95	0210471	470Ω ½W N.I.R. (G-2000)	2D
	0303361, 2	2SB560 (E, F) (G-3000)				0210681	680Ω ½W N.I.R. (G-3000)	
TR15,16	0308392, 3	2SD313 (E, F) (G-2000)		3B,2B	R 96	0210820	82Ω ½W N.I.R. (G-2000)	2C
	0306541, 2	2SC1986 (Q, Y) (G-3000)				0210151	150Ω ½W N.I.R. (G-3000)	
TR17,18	0303232, 3	2SB507 (E, F) (G-2000)	2B,1B	R 97	0210121	120Ω ½W N.I.R. (G-2000)	3C	
	0300911, 2	2SA771 (Q, Y) (G-3000)			0210271	270Ω ½W N.I.R. (G-3000)		
TR19	0308521, 2	2SD438 (E, F)	3C	R 98	0212829	8.2Ω 2W N.I.R.	2D	
IC 01,02	0360290, 1	2SA798 (E, F)	3B,2B	R 99,100	0211222	2.2 kΩ 1W N.I.R.	2C	
D 01,02	0310340	10D1	3C	VR01	1011130, 1	250 kΩ (B) x 2	Level Volume	
D 03 ~ 06	0310340	10D1 (G-2000)	Diode	VR02	1015300, 1	100 kΩ x 2	Bass Volume	
	0311530	30D2 (G-3000)		3C	VR03	1015300, 1	100 kΩ x 2	Treble Volume
D 07 ~ 10	0310340	10D1 Diode		2C	S 01	1101850	Rotary Switch (SP Selector)	1D
D 11	0311160	1S2473D (G-3000 only)	2B					
ZD01	0315970	EQA01-13R Zener Diode	2B	F 01	0432220	1A 250V	2C	
C 41	0655103	10,000 pF 500V C.C.	2C	F 02,03	0432280	4A 125V Fuse (G-2000)	2C	
C 42,43	0549008	4,700 μF 35V E.C. (G-2000)	3C		0432290	5A 125V AC Fuse (G-3000)		
	0549009	6,800 μF 35V E.C. (G-3000)		J 01	2430380	Head Phone Jack Socket (G-2000)	1D	
R 55,56	0210182	1.8 kΩ ½W N.I.R.	2B		2430360	Head Phone Jack Socket (G-3000)		
R 67,68	0192101	100Ω ½W F.R.	3B,1B		2210340	4P Output Terminal		
R 69 ~ 72	0192221	220Ω ½W F.R.	3B,2B		2310220	Fuse Holder (Large)		
R 73 ~ 76	0192689	6.8Ω ½W F.R.	1,2B					
R 77 ~ 80	0212338	0.33Ω 2W N.I.R.	1,2B					
R 81,82	0211221	220Ω 1W N.I.R.	1D					
R 83,84	0210479	4.7Ω ½W N.I.R.	1D					

3) F-2708 Circuit Board for Signal Meter

(Stock No. 7521561, G-2000) (Stock No. 7521531, G-3000)

Conductor Side

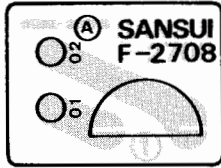

Parts List

Parts No.	Stock No.	Description
M01	4301110, 1	Signal Meter

4) F-2709 Circuit Board for Tuning Meter

(Stock No. 7521571, G-2000) (Stock No. 7521541, G-3000)

Conductor Side

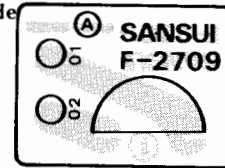

Parts List

Parts No.	Stock No.	Description
M02	4301120, 1	Tuning Meter

5) F-2710 Circuit Board for Stereo Indicator

(Stock No. 7540801, G-2000) (Stock No. 7540811, G-3000)

Conductor Side

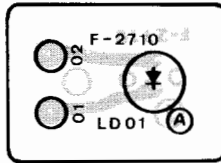

Parts List

Parts No.	Stock No.	Description
LD01	0319060	Light Emitted Diode

6) F-2712 Loudness Circuit Board

(Stock No. 7561951, G-2000) (Stock No. 7561961, G-3000)

Conductor Side

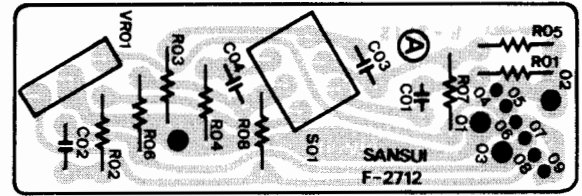

Parts List

Parts No.	Stock No.	Description
VR01	1005350, 1	250 kΩ (B) x 2 Balance Volume
S 01	1131490, 1	Push Switch, loudness

7) F-2713 Microphone Amp Circuit Board

(Stock No. 7610161, G-2000) (Stock No. 7610151, G-3000)

Conductor Side

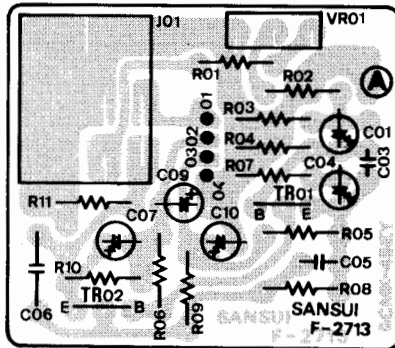

Parts List

Parts No.	Stock No.	Description
TR01	0300470, 1	2SA726W (F, G) } Transistor
TR02	0306070, 1	
VR01	1005340, 1	20 kΩ (A) Mixing Volume
J01	2430370	Mic. Jack Socket

8) F-2716 Voltage Selector Circuit Board

(Stock No. 7502491, G-2000) (Stock No. 7502501, G-3000)

Conductor Side

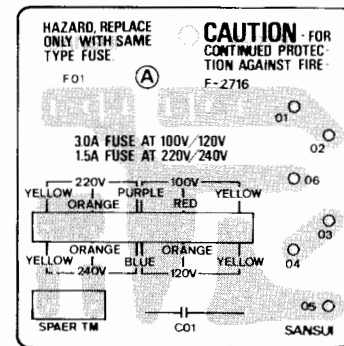

Parts List

Parts No.	Stock No.	Description
C 01	0659802	0.004 μF 150V C.C.
F 01	0432230	1.5A 250V
	0432250	2.5A 250V (G-2000)
	0432260	3A 250V (G-3000)
	2310220	Fuse Holder (Large)

Abbreviations

C.R. : Carbon Resistor	E.C. : Electrolytic Capacitor
S.R. : Solid Resistor	BP.E.C. : Bi-Polar Electrolytic Capacitor
Ce.R. : Cement Resistor	C.C. : Ceramic Capacitor
M.R. : Metal Film Resistor	MI.C. : Mica Capacitor
F.R. : Fusing Resistor	O.C. : Oil Capacitor
N.I.R. : Non-Inflammable Resistor	P.C. : Polystyrene Capacitor
M.C. : Mylar Capacitor	T.C. : Tantalum Capacitor

NOTE:

◇ **Changing Power Supply Voltage:** (This is applicable for universal type of G-2000/3000 only).

Your unit is adjusted to operate at the correct power supply voltage of your area prior to shipment from our factory. If you move to an outside country after purchasing it or send it as a gift to a friend living in an area where the voltage is different, it may be necessary to operate at the correct power supply voltage.

◇ When necessary, remove the bonnet from the unit and re-connect leads from power supply circuit board as described below in accordance with the required voltage (100V, 120V, 220V or 240V).

1) For 100V

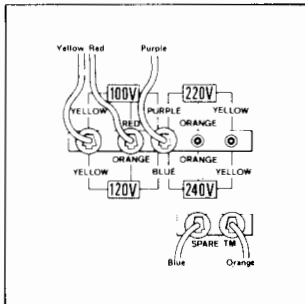

2) For 120V

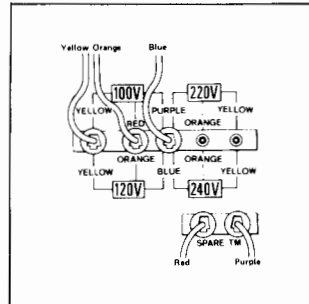

3) For 220V

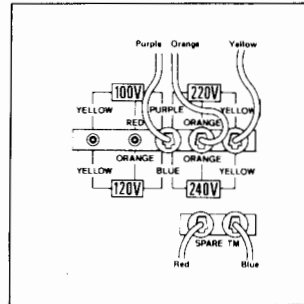

4) For 240V

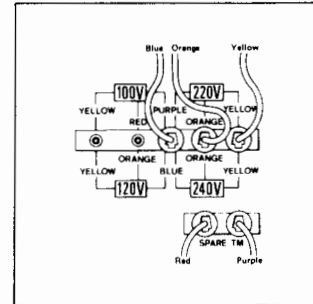

5. PARTS REPLACEMENT

1) Square Knobs of Loudness, FM Muting, Mode & Tape Monitor

1. Take off a wood bonnet, front & inside panels.
2. Then, pull out knobs to which are not glued as Fig. 1.

2) Tuning & Signal Meter

1. Complete 1. & 2. above.
2. Take off the meter as Fig. 2, then put it back into same place until snapped.

Fig. 1

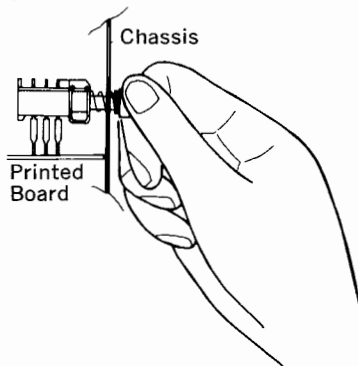

Fig. 2

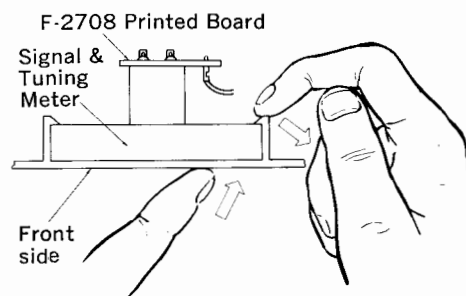
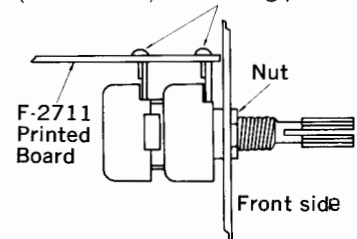

Fig. 3 Level Volume

(Bottom side) Soldering points



6. OTHER PARTS

◀Front View▶

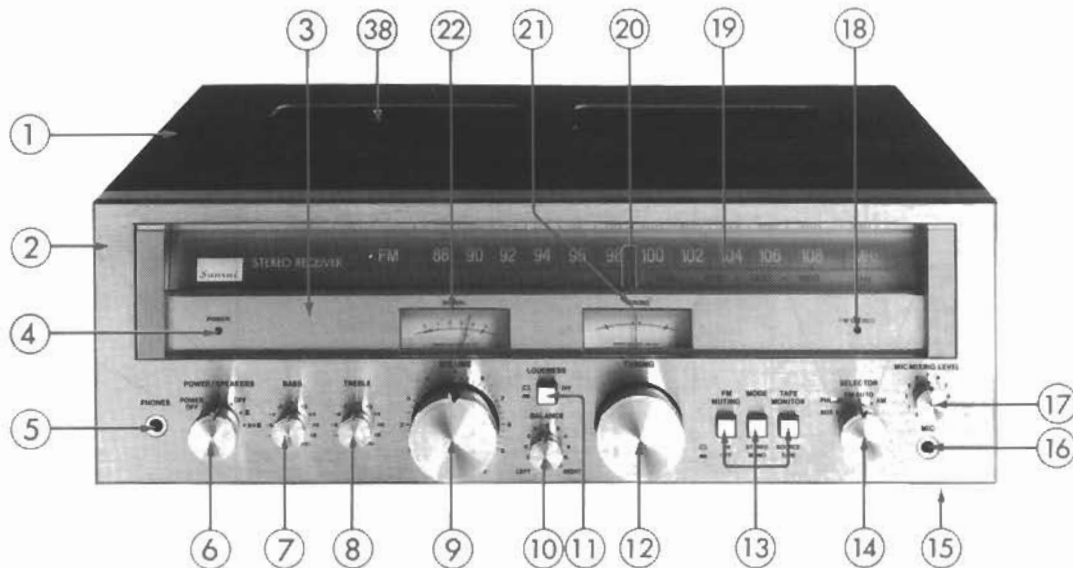

Parts List (Front & Top view)

Parts No.	Stock No.	Description	Parts No.	Stock No.	Description
1	5727060	Wood Bonnet	18	0319060	L.E.D., FM Stereo Indicator
	5236690	W.B. Type Bushing		5289180	L.E.D. Holder
2	7007640	Front Panel Ass'y (G-2000)		5136030	Plastic Rivet
	7007630	Front Panel Ass'y (G-3000)	19	5408200	Dial Scale (G-2000)
3	5305690	Inside Panel		5408190	Dial Scale (G-3000)
4	5426410	Power Illuminator Bar		5305720	Backside Panel for dial scale
5	2430380	Head Phone Jack Socket (G-2000)	20	7116030	Dial Pointer Ass'y
	2430360	Head Phone Jack Socket (G-3000)	21	4301120, 1	Tuning Meter
6	5319140	Power & Speakers Switch Knob	22	4301110, 1	Signal Meter
	1190530	Power & Speakers Rotary Switch (G-2000)	23	2450060	AC Outlet
	1101850	Power & Speakers Rotary Switch (G-3000)	24	3910600	AC Cord Clip
	5236470	M9 x 7, spacer nut	25	3800010, 4	AC Cord
7	5319130	BASS Volume Knob	26	2210340	4P Output Speaker Terminal (G-3000)
	1015300, 1	100k Ω x 2 Bass Volume	27	2090030	5P DIN Socket
8	5319130	Treble Volume Knob	28	2200410, 1	8P Input Terminal
	1015300, 1	100k Ω x 2 Treble Volume	29	2230180	Ground Terminal
9	5318980	Volume Knob	30	2210330	4P Antenna Terminal
	1005350, 1	250k Ω (B) x 2 Volume	31	6146670	D-44 Type Pulley
10	5319130	Balance Volume Knob	32	4200750	Bar Antenna
	1005350, 1	250k Ω x 2 (B) Balance Volume	33	5289170	Bar Antenna Holder
11	5326690	Loudness Switch Knob	34	7036540	Tuning Unit
	1131490, 1	Loudness Switch	35	7136100	Tension Unit
12	5318970	Tuning Knob	36	0400560	Pilot Lamp Ass'y
13	5326690	Knob, tape monitor switch	37	4002660	Power Transformer (G-2000)
	1131060, 1	Tape Monitor Switch		4002650	Power Transformer (G-3000)
14	5319140	Selector Switch Knob	38	5305710	Plastic Rear Panel
	1101840	Selector Switch	TR15, 16	0308392, 3	2SD313 (E, F) (G-2000)
	5236470	M9 x 7, spacer nut		0306541, 2	2SC1986 (Q, Y) (G-3000)
15	5058790	Bottom Plate	TR17, 18	0303232, 3	2SB507 (E, F) (G-2000)
	5517250	Leg		0300911, 2	2SA771 (Q, Y) (G-3000)
16	2430370	Microphone Jack Socket		5288721	Plate for TR
17	5319130	Microphone Mixing Volume Knob	C 701	0605337	0.033 μ F 250V M.C.
	1005340, 1	20k Ω (A) Mic Mixing Volume	R 701	0111335	3.3M Ω 1/2W S.R. (UL, CSA only)
				1230090	Trimmer Capacitor
				1220210	AM-FM Variable Capacitor

<Top View>

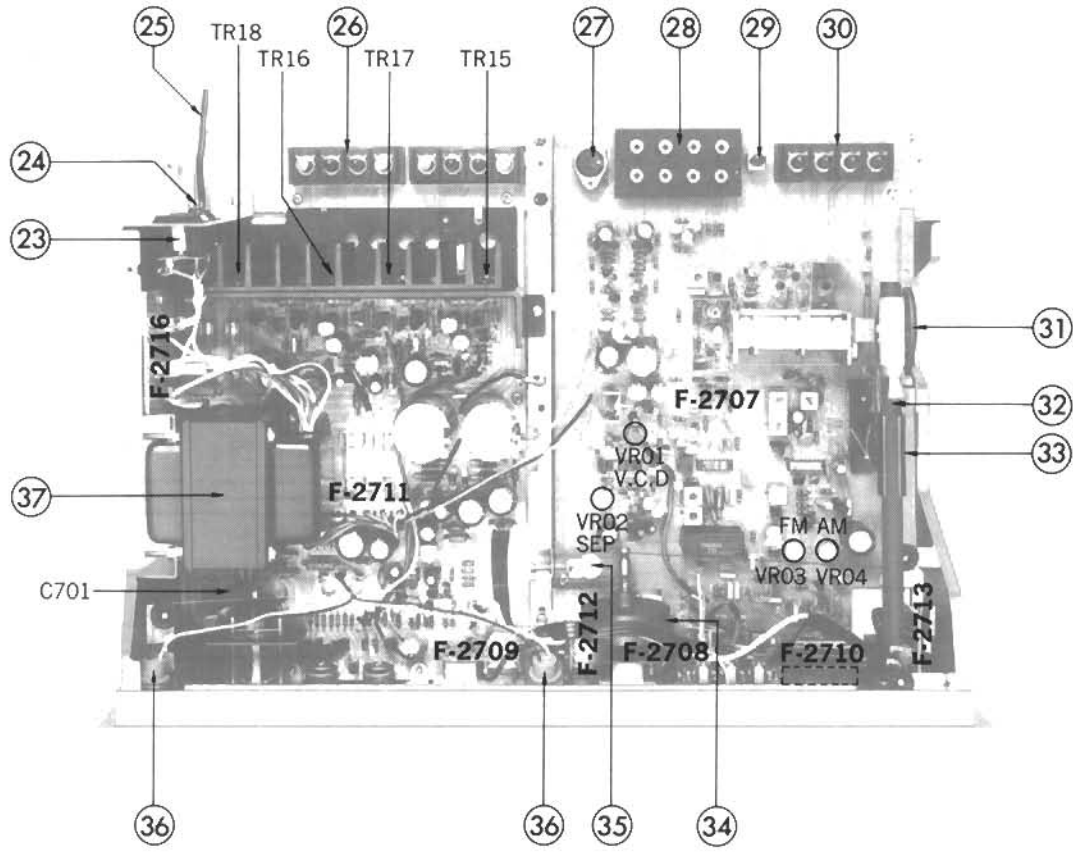

E

F

G

H

CHANNEL

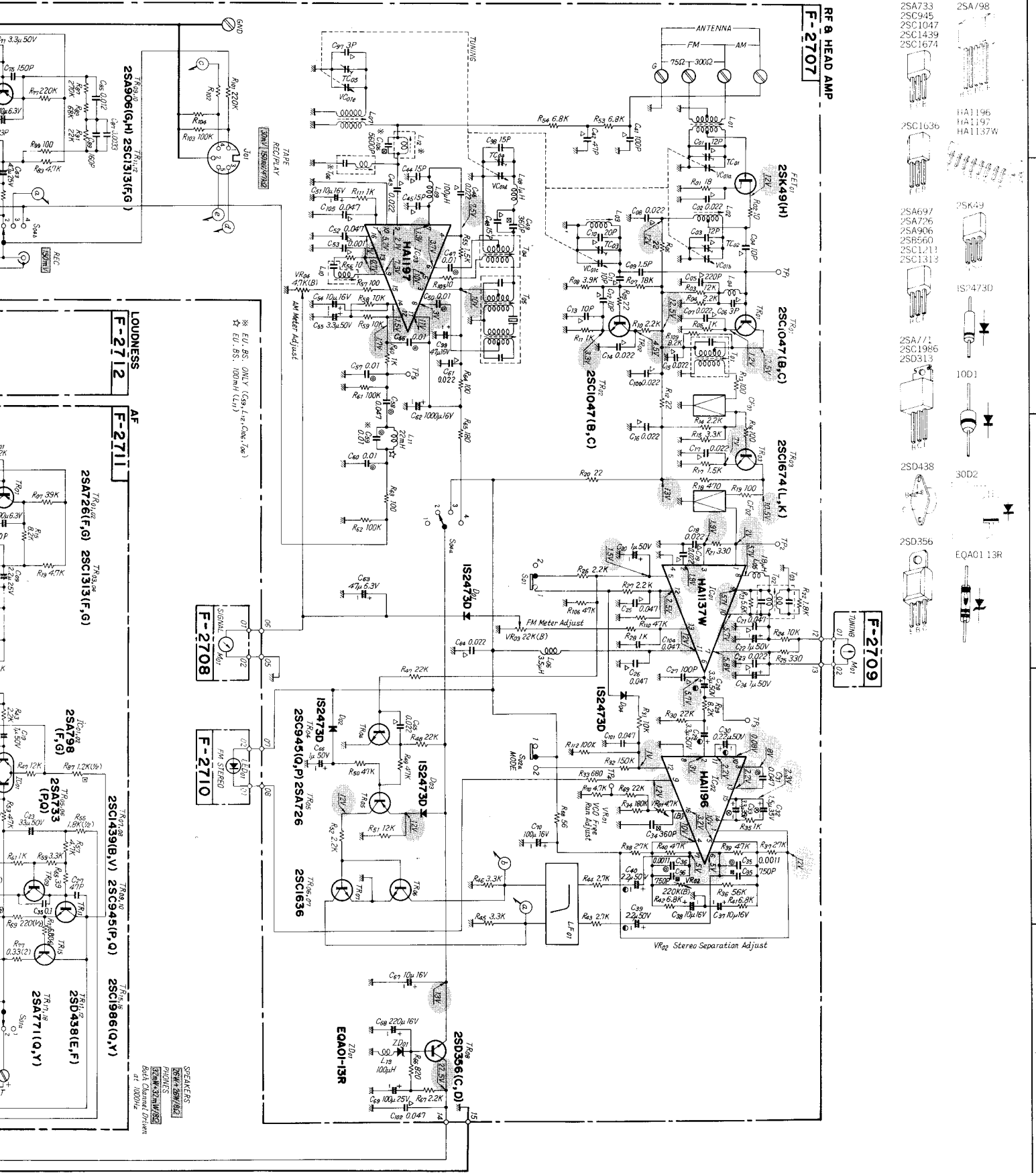

1

2

3

4

5

2SA733
 2SC945
 2SC1047
 2SC1439
 2SC1674

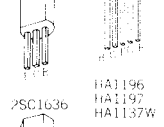

HA1196
 HA1197
 HA1137W

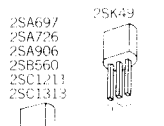

2SA697
 2SA726
 2SA906
 2SB560
 2SC1211
 2SC1313

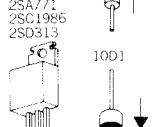

2SA771
 2SC1986
 2SD313



10D1
 2SD438
 30D2

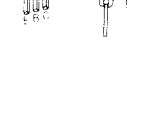

2SD356
 EQA0113R



RF & HEAD AMP
F-2707

2SK49(H)

2SC1047(B,C)

2SC1674(L,K)

F-2709

LOUDNESS
F-2712

AF
F-2711

SIGNAL METER
F-2708

FM STEREO
F-2710

SPEAKERS
 PHONES
 BUILT-IN HEADPHONE
 Both Channel Driven

8. THREADING OF DIAL CORD

- * If a dial cord is cut off or slips, replace it by following procedures.
As this unit uses 0.5 mm φ cord, please replace it with the same type certainly.
- * The length of dial cord is approximately 160 cm (65.3 inch).

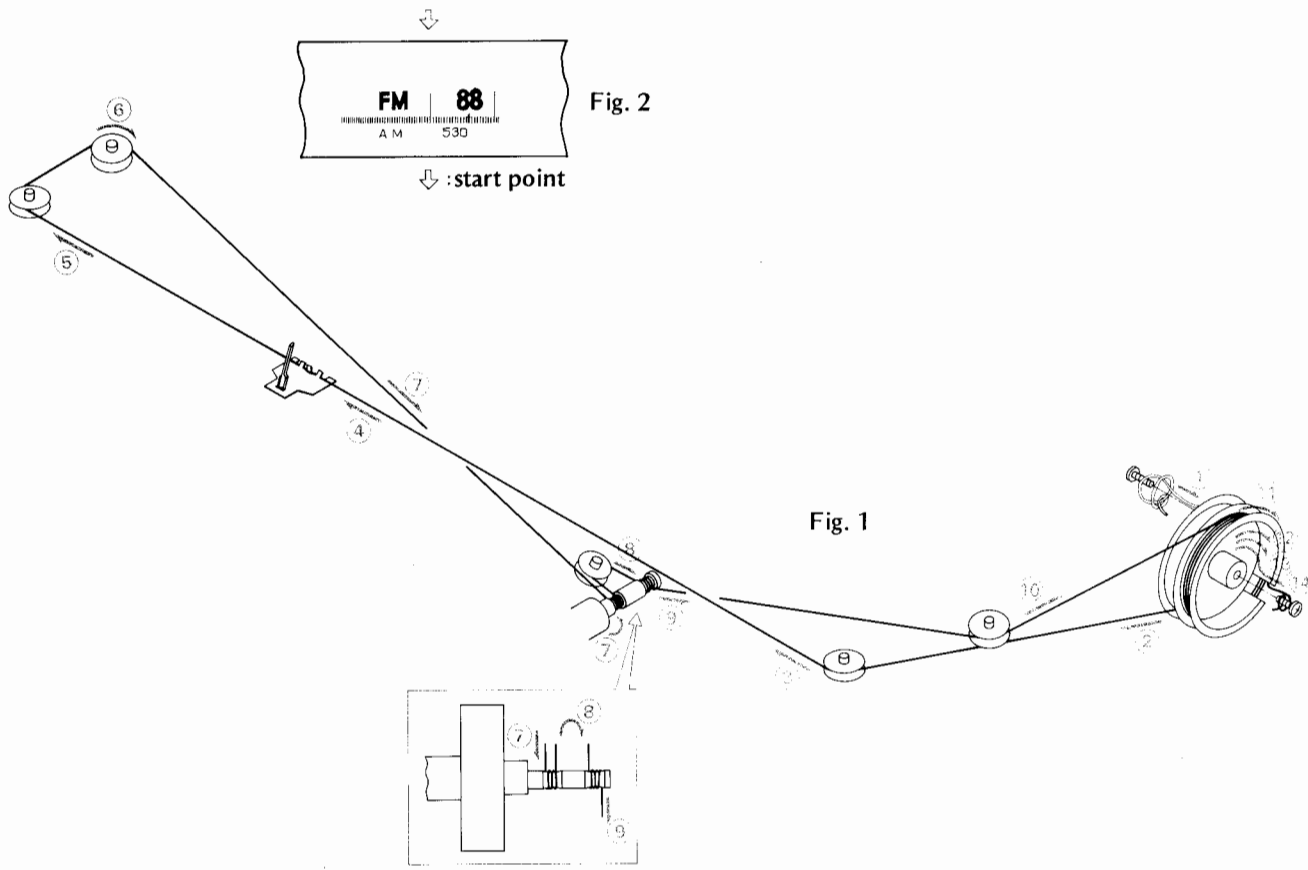
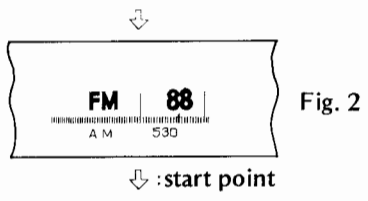

Threading of Dial Cord

Thread the dial cord in numerical order from 1 to 14 as Fig. 1.

- * Close the variable capacitor completely (Maximum Capacitance).

Attachment of Dial Pointer

- 1) Close the variable capacitor completely.
 - 2) Set the dial pointer to start point on dial scale as Fig. 2.
- * Confirm that the dial pointer runs smoothly on the dial scale by turning the turning shaft.

Stock No.	Description
6036050	Dial Cord (0.5 mm φ)
6146670	Dial Pulley

9. PACKING LIST

Parts No.	Stock No.	Description
1	9116143	Vinyl Cover
2	9028090	Stylofoam Packing
3	9009750	Carton Case (G-2000)
	9009740	Carton Case (G-3000)
4	5996080	Curl Stopper

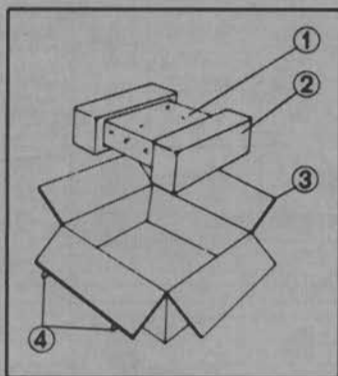

10. ACCESSORY PARTS LIST

Stock No.	Description
9202950	Operating Instructions (G-2000)
9202940	Operating Instructions (G-3000)
9237590	Schematic Diagram (G-2000)
9237580	Schematic Diagram (G-3000)
3820100	FM Antenna

MEMO

SANSUI ELECTRONICS CORPORATION: 55-11 Queens Blvd. Woodside, N.Y. 11377 U.S.A.
 333 West Alondra Blvd. Gardena, California 90247 U.S.A.
 3036 Koapaka St. Honolulu, Hawaii 96819 U.S.A.

SANSUI AUDIO EUROPE N.V.: North Trade Bldg (9th floor) Noorderlaan 133-Bus 1,2030 Antwerp, Belgium
 SANSUI AUDIO EUROPE S.A.: Arabella center, 6 Frankfurt AM Main, Lyoner Strasse 44-48, West Germany

SANSUI ELECTRIC COMPANY LTD.: 14-1, Izumi 2-chome, Suginamiku, Tokyo 168 Japan PHONE: (03) 323-1111/TELEX:232-2076