

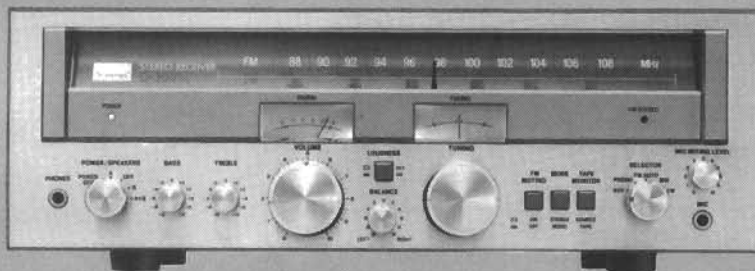

SERVICE MANUAL

STEREO RECEIVER

SANSUI G-2000SS/2000L G-3000L



SPECIFICATIONS

Audio Section

◀G-2000SS, G-2000L▶

Power output

Min. RMS, both channels driven, from 20 to 20,000 Hz,
with no more than 0.15% total harmonic distortion
16 watts per channel into 8 ohms
Load impedance 8 ohms
Total harmonic distortion

. less than 0.15% at or below
rated min. RMS power output

Intermodulation distortion (70 Hz : 7 kHz = 4:1 SMPTE
method) less than 0.15%

Frequency response (at 1 watt)

. 10 to 50,000 Hz +1 dB -2 dB

RIAA curve deviation (PHONO)

. +0.5 dB -0.5 dB
(30 to 15,000 Hz)

Damping factor approximately 30 at 8-ohms
load

Input sensitivity and impedance (1 kHz, for rated power
output)

PHONO 2.5 mV/47 kilohms
(Max. input capability; 190 mV at 1 kHz, less than
0.5% total harmonic distortion)

AUX, TAPE 150 mV/47 kilohms

MIC 8 mV/10 kilohms

Output level (1 kHz)

TAPE REC (pin jack) 150 mV/47 kilohms
(DIN) 43 mV

Channel separation (1 kHz, at rated power output)

PHONO better than 50 dB

AUX better than 50 dB

Hum and noise (short-circuit, A network)

PHONO 75 dB

AUX 95 dB

Controls

BASS ±10 dB (50 Hz)

TREBLE ±10 dB (10 kHz)

LOUDNESS (-30 dB)

. 7 dB at 50 Hz

. 5 dB at 10 kHz

◀G-3000L▶

Power output

Min. RMS, both channels driven, from 20 to 20,000 Hz,
with no more than 0.15% total harmonic distortion
26 watts per channel into 8 ohms
26 watts per channel into 4 ohms
Load impedance 4 and 8 ohms
Total harmonic distortion

. less than 0.15% at or below
rated min. RMS power output

Intermodulation distortion (70 Hz : 7 kHz = 4:1 SMPTE
method) less than 0.15%

Frequency response (at 1 watt)

. 10 to 50,000 Hz +1 dB -2 dB

RIAA curve deviation (PHONO)

. +0.5 dB -0.5 dB

(30 to 15,000 Hz)

Damping factor approximately 30 at 8 ohms
load

Input sensitivity and impedance (1 kHz, for rated power
output)

PHONO 2.5 mV/47 kilohms

(Max. input capability; 200 mV at 1 kHz, less than
0.5% total harmonic distortion)

AUX, TAPE 150 mV/47 kilohms

MIC 8 mV/10 kilohms

Output level (1 kHz)

TAPE REC (pin jack) 150 mV/47 kilohms

(DIN) 43 mV

Channel separation (1 kHz, at rated power output)

PHONO better than 50 dB

AUX better than 50 dB

Hum and noise (short-circuit, A network)

PHONO 75 dB

AUX 95 dB

Controls

BASS ±10 dB (50 Hz)

TREBLE ±10 dB (10 kHz)

LOUDNESS (-30 dB)

. 7 dB at 50 Hz

. 5 dB at 10 kHz



SANSUI ELECTRIC CO., LTD.

AM Section

◀G-2000SS▶

(SW1)
Tuning range 2.3 to 6.5 MHz
Usable sensitivity 20 μ V
Selectivity (± 10 kHz) 45 dB
Signal to noise ratio 46 dB

(SW2)
Tuning range 6.5 to 18 MHz
Usable sensitivity 30 μ V
Selectivity (± 10 kHz) 45 dB
Signal to noise ratio 46 dB

◀G-2000L, G-3000L▶

(MW)
Tuning range 530 to 1,600 kHz
Usable sensitivity (Bar antenna)
. 50 dB/m (300 μ V/m)
Selectivity (± 10 kHz) 45 dB
Signal to noise ratio 46 dB

(LW)
Tuning range 150 to 350 kHz
Usable sensitivity 60 dB/m (1,000 μ V/m)
(bar antenna)
300 μ V (EXT)
Selectivity 45 dB
Signal to noise ratio 46 dB

FM Section

◀G-2000SS, G-2000L, G-3000L▶

Tuning range 88 to 108 MHz
Usable sensitivity
Mono IHF 11.0 dBf (1.95 μ V)
DIN 1.2 μ V
Stereo IHF 19.0 dBf
50 dB quieting sensitivity
Mono 15 dBf
Stereo 39 dBf
Signal to noise ratio (at 65 dBf)
Mono 71 dB
Stereo 68 dB
Distortion (at 65 dBf)
Mono less than 0.18% at 100 Hz
less than 0.15% at 1,000 Hz
less than 0.25% at 6,000 Hz
Stereo less than 0.3% at 100 Hz
less than 0.25% at 1,000 Hz
less than 0.30% at 6,000 Hz
Alternate channel selectivity (at 400 kHz)
. 50 dB
Capture ratio 1.3 dB
Image response ratio 48 dB (at 98 MHz)
Spurious response ratio 70 dB (at 98 MHz)
Stereo separation 30 dB at 100 Hz
40 dB at 1,000 Hz
28 dB at 10,000 Hz
Frequency response 30 to 15,000 Hz
+0.5 dB -1.0 dB
Antenna input impedance
. 300 ohms balanced
75 ohms unbalanced

Others

◀G-2000SS, G-2000L, G-3000L▶

Power requirements
Power voltage 100, 120, 220, 240V
(50/60 Hz) ◀G-2000SS▶
220, 240V (50 Hz)
◀G-2000L, G-3000L▶
Power consumption 155 watts ◀G-2000SS, G-2000L▶
210 watts ◀G-3000L▶
Dimensions 433 mm (17-1/16") W
153 mm (6-1/16") H
352 mm (13-7/8") D
Weight 7.3 kg (16.1 lbs) net
G-2000SS, 2000L
8 kg (17.6 lbs) net ◀G-3000L▶
8.7 kg (19.2 lbs) packed
◀G-2000SS, G-2000L▶
9.4 kg (20.7 lbs) packed ◀G-3000L▶

* Design and specifications subject to change without notice for improvements.

1. OPERATIONS

Pop-noise preventive circuit

In order to prevent the annoying pop-noise to the loudspeakers at turning the power of the amplifier ON, the pop-noise preventive circuit adopted in the G-3000L is the combination of the conventional driver-voltage delay type used in the power supply (rectifier) circuit and the NF delay type pop-noise preventive circuits. The configuration of NF delay type pop-noise preventive circuit is shown in Fig. 1.

In this circuit, the switching (ON-OFF) of the transistor TR05 is made by the time constant of the capacitor C40 and resistor R88. Thereby the NF resistor, R51 is controlled, and the gain of the main amplifier stage is lowered when TR05 is ON, thus the voltage drift (transient voltage) of the main amplifier at turning the power ON does not appear on the speaker terminals for very short period of time. In other words, at the instant that the power is turned ON, the voltage at the point A rises up to +13V, then the voltage decreases by means of the time constant of C40 and R88 as shown in Fig. 2. At this time, the diode D11 is inversely biased, consequently, the potential voltage of the point B is 0V as Fig. 3. Because of this, TR05 turns to the cut-off, thus the NF resistor, R51 acquires such a state as its resistance value becomes equivalently very large, which decreases the gain of the power amplifier. When the charge of the C40 is completed, the voltage of the point B (see Fig. 3) becomes negative, as a result, the diode D11 is biased. Therefore, TR05 is turned ON, and the circuit of this equipment is normally operated approximately 2 seconds after the power is turned ON to prevent the pop-noise which flows to loudspeakers.

Fig. 1

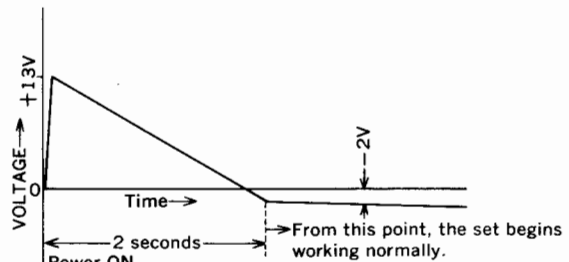
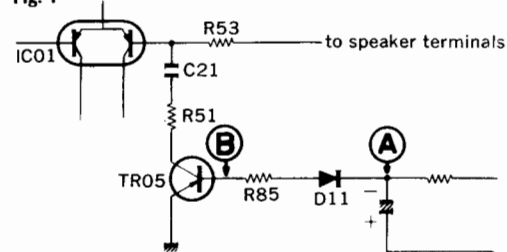

Fig. 2 Voltage variation during a certain period of time at A

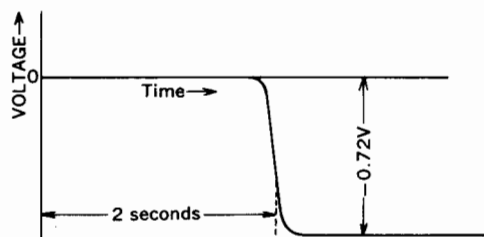

Fig. 3 Voltage variation at B

3. ADJUSTMENTS

1. FM Adjustment

* Refer to the picture of top view and illustrations indicating test points on page 4.

- Note: 1. Selector FM AUTO
 2. FM Muting Switch OFF
 3. Connection . . Connect the output of genescopes to TP through 100pF ceramic capacitor.

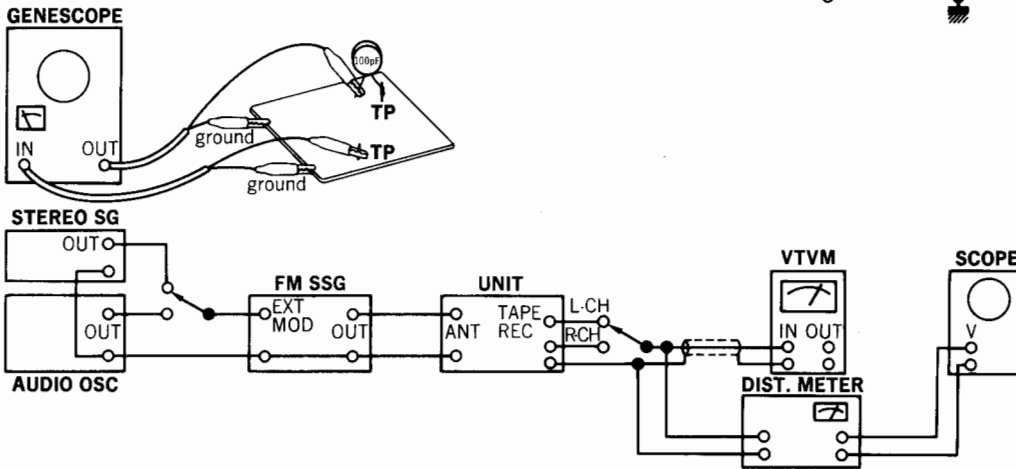
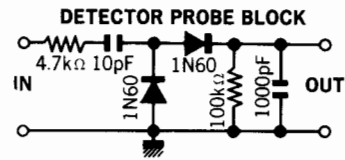

FM IF Adjustment & Dial Calibration <<G-2000SS/G-2000L/G-3000L>>

STEP	SUBJECT	FEED SIGNAL		MEASURE OUTPUT	ADJUST	ADJUST FOR	REMARKS
		FROM	TO				
1.	IF Coil	Output 60 dB Genescopes	TP1 F-2824	Point (A) F-2824 Use Detector Probe	T01 F-2824	Max. IF waveform	
2.	Discriminator Coil	Same as above	Same as above	Point (B) F-2824	T02, T03 F-2824	Steep linearity of S curve Make symmetrical S curve	
3.	Tuning Meter	98 MHz ANT Input 65 dBf (59.8 dB) 1000 Hz (100% MOD) FM SSG	ANT terminal 300Ω	Tuning Meter	T02 F-2824	Center on Meter	Tuning
4.	90 MHz Dial Calibration	90 MHz ANT Input 65 dBf (59.8 dB) 1000 Hz (100% MOD) FM SSG	Same as above	REC terminal L or R-CH VTVM & Scope	L03 F-2824	MAX. output	
	106 MHz Dial Calibration	106 MHz ANT Input 65 dBf (59.8 dB) 1000 Hz (100% MOD) FM SSG	Same as above	Same as above	TC03 F-2824		
5.	90 MHz RF Adj.	90 MHz ANT Input Minimum value with sine wave 400 Hz (100% MOD) FM SSG	Same as above	Same as above	L01, L02 F-2824	Same as above	
	106 MHz RF Adj.	106 MHz ANT Input Minimum value with sine wave 400 Hz (100% MOD) FM SSG	Same as above	Same as above	TC01, TC02 F-2824	Same as above	
6.	Signal Meter Volume	98 MHz ANT Input 65 dBf (59.8 dB) 1000 Hz (100% MOD) FM SSG	Same as above	Signal Meter	VR03 F-2824	4.3 on Meter	

FM STEREO Adjustment

STEP	SUBJECT	FEED SIGNAL		MEASURE OUTPUT	ADJUST	ADJUST FOR	REMARKS
		FROM	TO				
1.	PLL VCO Adj.	98MHz ANT Input 65dBf (59.8dB) FM SSG Pilot 19kHz (9% MOD) SUB 1kHz + Pilot (100% MOD) STEREO SG	ANT terminal 300 Ω	Stereo indicator	VR01 F-2824	Light indicator	Adjust the VR01 within center of lighting level.
	PLL VCO Adj. In case of using Freq. counter.	98MHz ANT Input 65dB (59.8dB) FM SSG	Same as above	TP4 F-2824 Use Freq. counter	VR01 F-2824	76kHz ±150Hz	
2.	Separation	98 MHz ANT Input 65 dBf (59.8 dB) FM SSG Pilot 19 kHz (9% MOD) R Mode 1 kHz + Pilot (100% MOD) STEREO SG	Same as above	REC terminal L-CH VTVM & Scope	VR02 F-2824	Set -34 dB	Confirm separation L-CH → R-CH (-34 dB)

<Top View> <G-3000L> * Test points of G-2000SS & G-2000L are located the same as G-3000L.

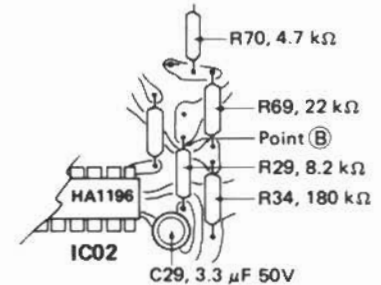
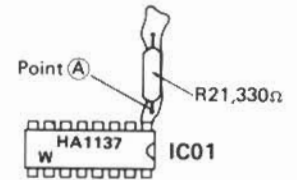
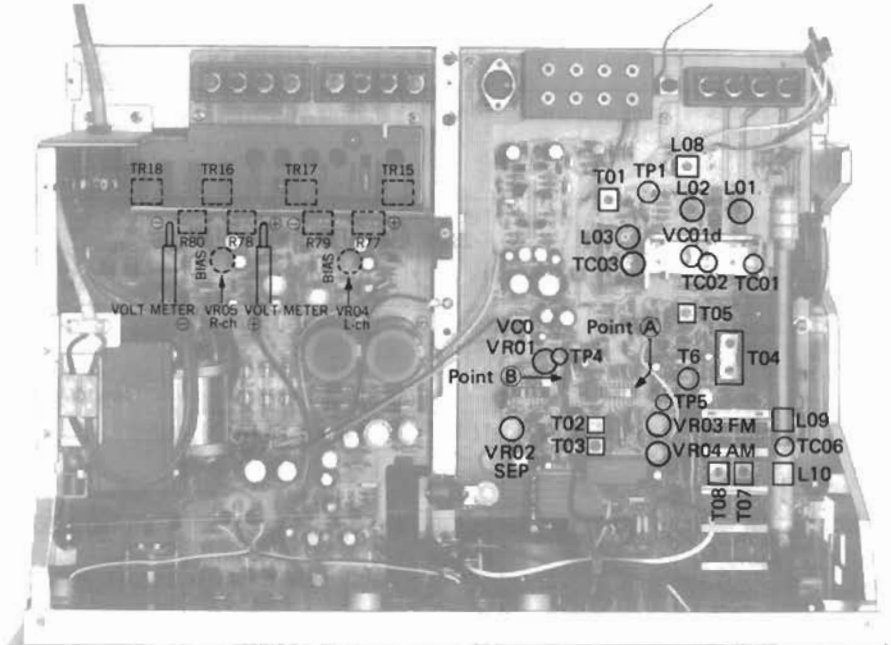

NEW MEASUREMENT FOR FM.

Input signal level under the provision of IHFM-T-200, a new measurement method is indicated by available power ratio "dBf". To obtain approximate available power ratio "dBf", abstract 0.8 from attenuator indication of general FMSG (open load indication type); however, the conventional measurement, IHFM-T-100 is designated together too.

The way of modulation on IHFM-T-200 is shown below.

	modulation frequency	modulation mode	modulation factor
FM MONO	1000Hz		100%
FM STEREO	1000Hz	SUB	Pilot 9% Pilot + SUB 100%

※ The relation between the standard input 65 dBf of IHFM-T-200 and the former indication "dB" is shown in below.

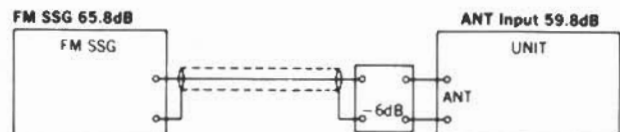



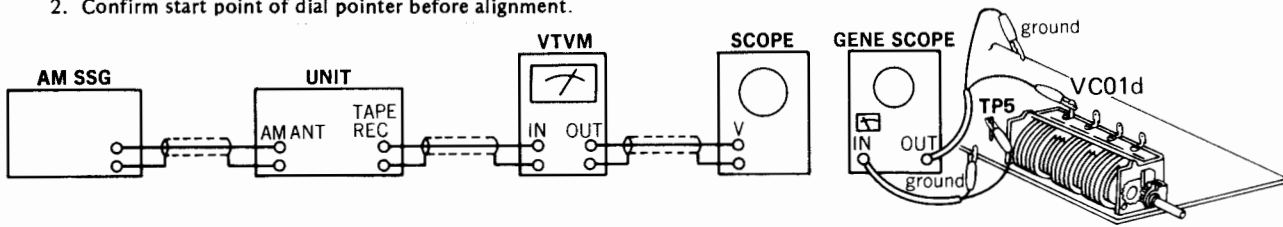

2. AM IF Adjustment & Dial Calibration



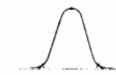
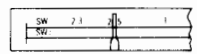
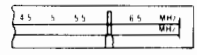
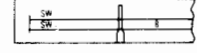

- Note: 1. Selector SW₁ & SW₂ <<G-2000SS>>
MW & LW <<G-2000L, G-3000L>>
2. Confirm start point of dial pointer before alignment.

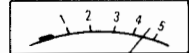

<<G-2000SS>>

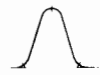
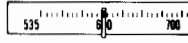
STEP (Selector)	SUBJECT	FEED SIGNAL		MEASURE OUTPUT	ADJUST	ADJUST FOR	REMARKS
		FROM	TO				
1	IF Coil	Genescope output level 60 dB	VC01d F-2824	TP5 F-2824	T04, T05, T06 F-2824	MAX. IF waveform	
2 (SW ₁)	2.5 MHz Dial Calibration	2.5 MHz ANT Input 60 dB 400 Hz (MOD 30%) AM SSG	AM ANT Terminal	REC terminal L or R-CH VTVM & Scope	T07 F-2824	MAX. indication on signal meter & VTVM	
	6 MHz Dial Calibration	6 MHz ANT Input 60 dB 400 Hz (MOD 30%) AM SSG	Same as above	Same as above	TC04 F-2824	Same as above	
3 (SW ₂)	7 MHz Dial Calibration	7 MHz ANT Input 60 dB 400 Hz (MOD 30%) AM SSG	Same as above	Same as above	T08 F-2824	Same as above	
	16 MHz Dial Calibration	16 MHz ANT Input 60 dB 400 Hz (MOD 30%) AM SSG	Same as above	Same as above	TC05 F-2824	Same as above	
4 (SW ₁)	2.5 MHz RF Adj.	2.5 MHz ANT Input 50 dB 400 Hz (MOD 30%) AM SSG	Same as above	Same as above	L09 F-2824	Same as above	
	16 MHz RF Adj.	16 MHz ANT Input 50 dB 400 Hz (MOD 30%) AM SSG	Same as above	Same as above	TC06 F-2824	Same as above	
5 (SW ₂)	7 MHz RF Adj.	7 MHz ANT Input 50 dB 400 Hz (MOD 30%) AM SSG	Same as above	Same as above	L10 F-2824	Same as above	
	16 MHz RF Adj.	16 MHz ANT Input 50 dB 400 Hz (MOD 30%) AM SSG	Same as above	Same as above	TC07 F-2824	Same as above	
6	Signal Meter Volume	1000 kHz ANT Input 80 dB/m 400 Hz (MOD 30%) AM SSG	Same as above	Signal Meter	VR04 F-2824	4.5 on meter	

◀G-2000L/3000L▶

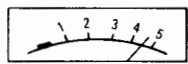
STEP (Selector)	SUBJECT	FEED SIGNAL		MEASURE OUTPUT	ADJUST	ADJUST FOR	REMARKS
		FROM	TO				
1	IF Coil	Genescope output level 60 dB	VC01d F-2824	TP5	T04, T05, T06 F-2824	MAX. IF waveform	
2 (MW)	600 kHz Dial Calibration	600 kHz ANT Input 60 dB 400 Hz (MOD 30%) AM SSG	AM ANT Terminal	REC terminal L or R-CH VTVM & Scope	T07 F-2824	MAX. indication on signal meter	
	1400 kHz Dial Calibration	1400 kHz ANT Input 60 dB 400 Hz (MOD 30%) AM SSG	Same as above	Same as above	TC04 F-2824		
3 (LW)	150 kHz Dial Calibration	150 kHz ANT Input 60 dB 400 Hz (MOD 30%) AM SSG	Same as above	Same as above	T08 F-2824	Same as above	
	350 kHz Dial Calibration	350 kHz ANT Input 60 dB 400 Hz (MOD 30%) AM SSG	Same as above	Same as above	TC05 F-2824		
4 (MW)	600 kHz RF Adj.	600 kHz ANT Input 50 dB 400 Hz (MOD 30%) AM SSG	Same as above	Same as above	L07a Bar Antenna Coil	Same as above	
	1400 kHz RF Adj.	1400 kHz ANT Input 50 dB 400 Hz (MOD 30%) AM SSG	Same as above	Same as above	TC06 F-2824	Same as above	
5 (LW)	150 kHz RF Adj.	150 kHz ANT Input 50 dB 400 Hz (MOD 30%) AM SSG	Same as above	Same as above	L07b Bar Antenna Coil	Same as above	
	350 kHz RF Adj.	No this adjustment is necessary.					
6	Signal Meter Volume	1000 kHz ANT Input 80 dB 400 Hz (MOD 30%) AM SSG	Same as above	Signal Meter	VR04 F-2824	4.5 on meter	

3. Bias Current Adjustment (See the picture of top view on page 4)

◀G-2000S, G-2000L, G-3000L▶

1. Confirm AC power supply voltage, 220 V or 240 V provided.
2. Level Volume Minimum
3. Room Temperature 18°C ~ 28°C
(65°F ~ 83°F)
4. Before this adjustment, turn bias adjustment volumes of VR04 and VR05 fully counterclockwise, then run this unit for more than three minutes.

Note: For this adjustment, put the lead + (plus) side of volt meter to + (plus) side of R77 (& R78), and the lead - (minus) side of R79 (& R80) on both channels.

L-ch R77, R79 (Measure output voltage)
R-ch R78, R80 on both channels)

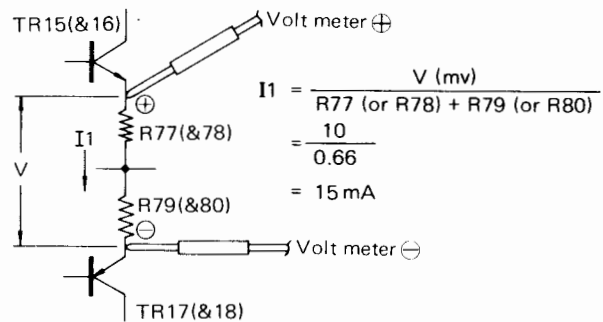

Fig. 1 (Power stage on F-2711)

$$I_1 = \frac{V \text{ (mv)}}{R77 \text{ (or R78)} + R79 \text{ (or R80)}} = \frac{10}{0.66} = 15 \text{ mA}$$

STEP	SUBJECT	EQUIPMENT	MEASURE OUTPUT	ADJUST	ADJUST FOR
1	Bias Current L-CH	DC Volt meter	* See Fig. 1 above	VR04 F-2711	10 mV ±1 mV (15 mA)
2	Bias Current R-CH	DC Volt meter	* See Fig. 1 above	VR05 F-2711	10 mV ±1 mV (15 mA)

4. PARTS LOCATION & PARTS LIST

Since some of capacitors and resistors are omitted from parts lists in this Service Manual, refer to the Common Parts List for capacitors & resistors which was appended previously to each Sansui Manual.

1. F-2711 Pre/Main & Power Supply Circuit Board (Stock No. 7571821, G-2000SS) (Stock No. 7571831, G-2000L) (Stock No. 7571811, G-3000L)

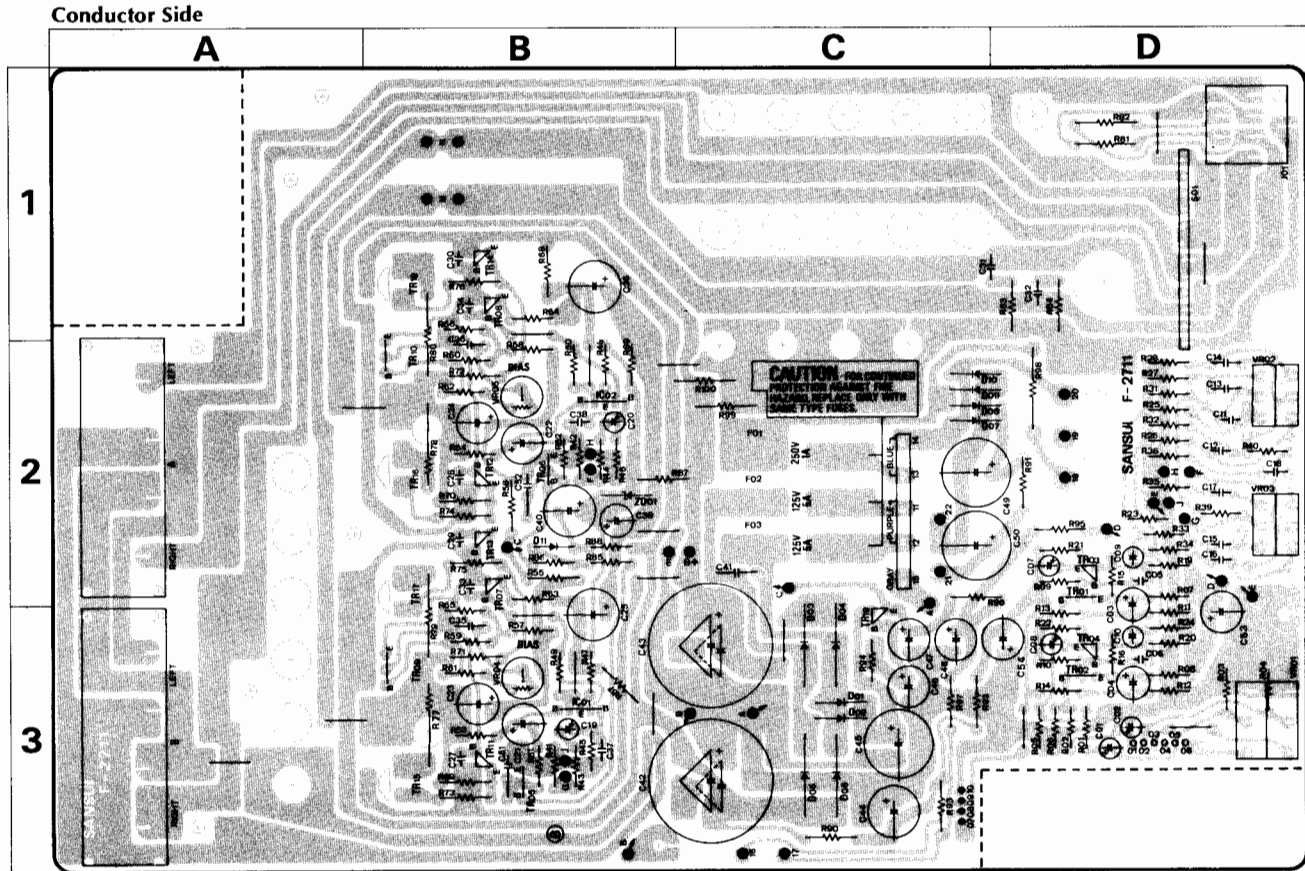

Parts List

Parts No.	Stock No.	Description	Position	Parts No.	Stock No.	Description	Position	Parts No.	Stock No.	Description	Position
TR01,02	0300470,1	2SA726W (F, G)	2D,3D			◀G-2000SS, G-2000L▶				Level Volume	
TR03,04	0306070,1	2SC1313 (F, G)	2D,3D			6,800 μF 35V E.C.		VR02	1015300,1	100 kΩ (A) x 2	2D
TR05,06	0300510,1	2SA733 (P, G)	3B		0549009	◀G-3000L▶				Bass Volume	
		◀G-3000L only▶						VR03	1015300,1	100 kΩ (A) x 2	2D
TR07,08	0306371,2	2SC1175 (E, F)	2B	R 55,56	0210182	1.8 kΩ 1/4W N.I.R.	2B			Treble Volume	
		◀G-2000SS, G-2000L▶		R 67,68	0192101	100 Ω 1/4W F.R.	3B,1B	VR04,05	1035050	470 Ω (B)	3B,2B
	0306521,2	2SC1439 (B, V)		R 69~72	0192221	220 Ω 1/4W F.R.	3C,2B			Bias Adjusting Volume	
		◀G-3000L▶		R 73~76	0192689	6.8 Ω 1/4W F.R.	2B,1B				
TR09,10	0305951,2	2SC945 (P, Q)	3B,2B	R 77~80	0212338	0.33 Ω 2W N.I.R.	3B,2B	S 701	1190530	Power Switch ◀G-2000SS▶	
TR11,12	0305930,1	2SC1211 (C, D)	3B,2B	R 81,82	0211221	220 Ω 1W N.I.R.	1D		1190600	Power Switch ◀G-2000L▶	
		◀G-2000SS, G-2000L▶		R 83,84	0210479	4.7 Ω 1/4W N.I.R.	1D		1101880	Rotary Switch,	
	0308521,2	2SD438 (E, F)		R 87	0210272	2.7 kΩ 1/4W N.I.R.	2B			Power/Speaker Selector	
		◀G-3000L▶				◀G-2000SS, G-2000L▶				◀G-3000L▶	
TR13,14	0300310,1	2SA697 (C, D)	Transistor 2B		0210122	1.2 kΩ 1/4W N.I.R.		F 01	0432220	1A 250V AC Fuse ◀G-2000SS▶	2C
		◀G-2000SS, G-2000L▶		R 90	0210221	220 Ω 1/4W N.I.R.	3C		0435090	800 mA 250V AC Fuse	
	0303361,2	2SB560 (E, F)				◀G-2000SS, G-2000L▶				◀G-2000L, G-3000L▶	
TR15,16	0308392,3	2SD313 (E, F)	3B,2B		0210271	270 Ω 1/4W F.R. ◀G-3000L▶		F 02,03	0432280	4A 125V AC Fuse ◀G-2000SS▶	2C
		◀G-2000SS, G-2000L▶		R 91	0192220	22 Ω 1/4W F.R.	2D		0435150	3,15A 125V AC Fuse	
	0306541,2	2SC1986 (Q, Y)		R 92	0210471	470 Ω 1/4W N.I.R.	3C			◀G-2000L▶	
		◀G-3000L▶				◀G-2000SS, G-2000L▶			0435160	4A 250V AC Fuse ◀G-3000L▶	
TR17,18	0303232,3	2SB507 (E, F)	2B,1B		0210681	680 Ω 1/4W N.I.R. ◀G-3000L▶		F 04,05	0432280	4A 125V AC Fuse ◀G-2000SS▶	
		◀G-2000SS, G-2000L▶		R 93	0210221	220 Ω 1/4W N.I.R.	3C		0435150	3,15A 125V AC Fuse	
	0300911,2	2SA771 (Q, Y)				◀G-2000SS, G-2000L▶				◀G-2000L▶	
		◀G-3000L▶		R 95	0210331	330 Ω 1/4W N.I.R. ◀G-3000L▶			0435160	4A 250V AC Fuse ◀G-3000L▶	
TR19	0306521,2	2SD438 (E, F)	3C	R 96	0210471	470 Ω 1/4W N.I.R.	2D	J 01	2430380	Headphone Jack Socket	1D
		◀G-2000SS, G-2000L▶				◀G-2000SS, G-2000L▶				◀G-2000SS, G-2000L▶	
IC 01,02	0360290,1	2SA798 (E, F)	3B,2B		0210681	680 Ω 1/4W N.I.R. ◀G-3000L▶			2430360	Headphone Jack Socket	
		◀G-2000SS, G-2000L▶		R 97	0210221	220 Ω 1/4W N.I.R.	3C		2210340	4P Speaker Output Terminal	
D 01,02	0310340	10D1	3C		0210151	150 Ω 1/4W N.I.R. ◀G-3000L▶			2310220	Fuse Holder ◀G-2000SS▶	
D 03~06	0310340	10D1	3C		0210221	220 Ω 1/4W N.I.R.			2310230	Fuse Holder	
		◀G-2000SS, G-2000L▶				◀G-2000SS, G-2000L▶				◀G-2000L, G-3000L▶	
	0311530	30D2 ◀G-3000L only▶	Diode 2C		0210271	270 Ω 1/4W N.I.R. ◀G-3000L▶					
D 07~10	0310340	10D1	3C	R 98	0212829	8.2 Ω 2W N.I.R.	2D				
D 11	0311160	1S2473D	2B	R 99,100	0211222	2.2 kΩ 1W N.I.R.	2C				
		◀G-3000L only▶									
ZD01	0315970	EQA01-13R Zener Diode	2D	L 01,02	4210290	RF Coil 1.5 μH					
						◀G-2000L, G-3000L▶					
C 41	0655103	10,000 pF 500V C.C.	2C	VR01	1011130,1	250 kΩ (B) x 2	3D				
C 42,43	0549008	4,700 μF 35V E.C.	3C								

2. F-2824 TUNER & PRE-AMP CIRCUIT BOARD

(Stock No. 7521651, G-2000SS) (Stock No. 7521591, G-2000L) (Stock No. 7521621, G-3000L)

Conductor Side

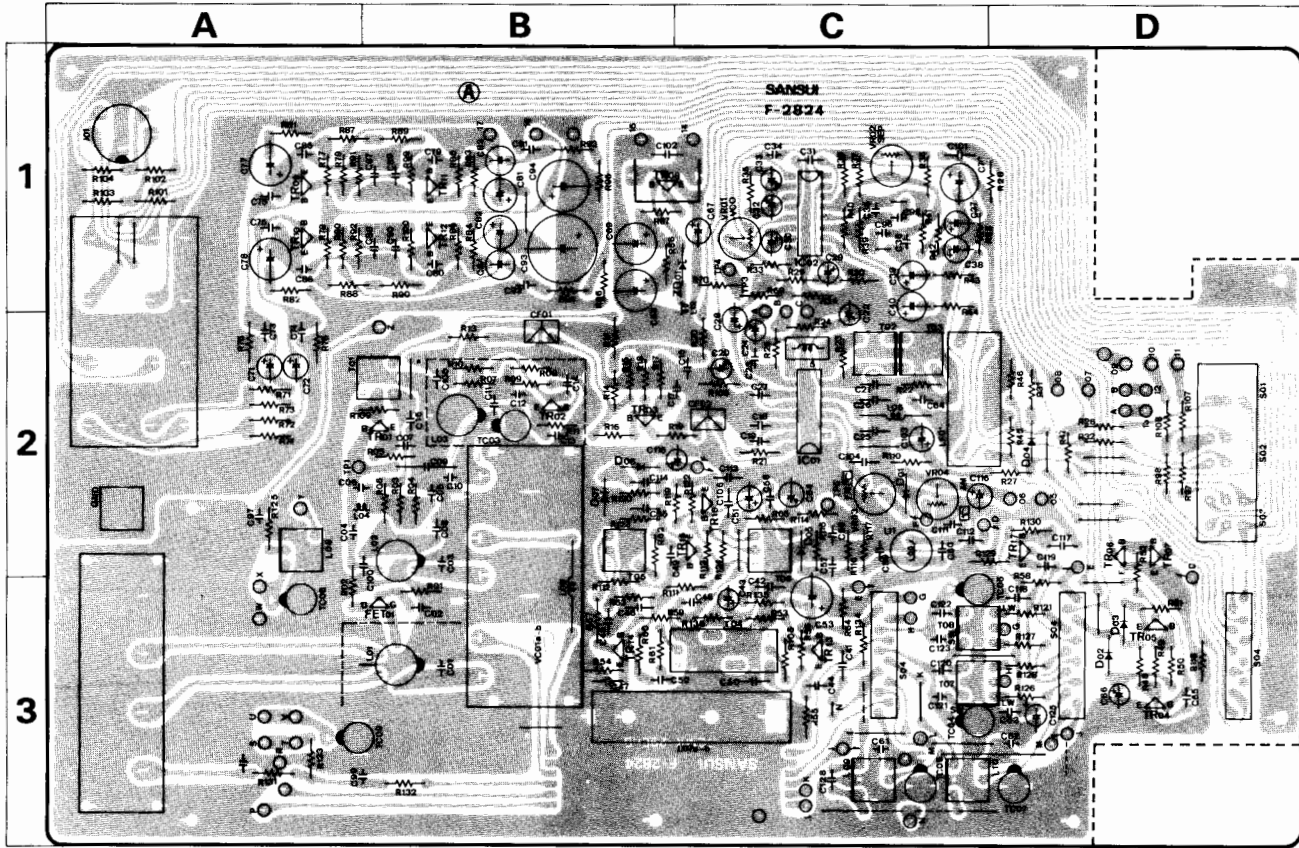

Parts List

Parts No.	Stock No.	Description	Position	Parts No.	Stock No.	Description	Position	Parts No.	Stock No.	Description	Position
TR01, 02	0305801, 2	2SC1047 (B, C)	2B	C 11, 12	0669270	10 pF 50V C.C. <<G-2000SS>>	2B	T 01	4235930	IF Coil (FM)	2B
TR03	0306341, 2	2SC1474 (L, K)	2B		0669370	10 pF 50V C.C.		T 02	4235990, 1	IF Coil (FM)	2C
TR04	0305951, 2	2SC945 (Q, P)	3D			<<G-2000L, G-3000L>>		T 03	4236000, 1	IF Coil (FM)	2C
TR05	0300470	2SA725W (F)	3D	C 13	0669356	10 pF 50V C.C. <<G-2000SS>>	2B	T 04	0910370	Ceramic Filter	3C
TR06, 07	0306581, 2	2SC1634	2B		0669370	10 pF 50V C.C.		T 05	4230610	IF Coil (AM)	2B
TR08	0308450, 1	2SD356 (C, D)	1B	C 32	0573159	1.5 μF 35VW T.C.	1C	T 06	4230500	IF Coil (AM)	2C
TR09, 10	0300900, 1	2SA906 (G, H)	1A	C 33	0573339	3.3 μF 35VW T.C.	1C	T 07	4220620	12 μH O.S.C. (AM) <<G-2000SS>>	3C
TR11, 12	0306070, 1	2SC1313 (F, G)	1B	C 34	0629005	360 pF 50V P.C.	1C	T 08	4220630	150 μH O.S.C. <<G-2000SS>>	3C
TR13	0306341, 2	2SC1674 (L, K)	3C	C 89, 90	0620161	160 pF 50V P.C.	1B		4220610	O.S.C. Coil <<G-2000SS>>	3C
		<<G-2000SS>>		C 95, 96	0620751	750 pF 50V P.C.	1C		4220600	740 μH O.S.C. Coil (AM)	
		<<G-2000L, G-3000L>>		C 120	0620152	1500 pF 50V P.C. <<G-2000SS>>	3C	CF01, 02	0910380	Ceramic Filter (FM)	2B, 2C
TR14	0306241, 2	2SC1675 (L, K)	3B		0620361	360 pF 50V P.C.		LF01	0910220	Low Pass Filter	2C
TR15	0306241, 2	2SC1675 (L, K)	2C			<<G-2000L, G-3000L>>		VR01	1034250	4.7 kΩ (B) VCO Free-Run	1C
TR16	0306241, 2	2SC1675 (L, K)	2C	C 122	0620332	3300 pF 50V P.C. <<G-2000SS>>	3C			Adjusting VR	
TR17	0306341, 2	2SC1675 (L, K)	2D		0620121	120 pF 50V P.C.		VR02	1035210	220 kΩ Stereo Separation	1C
		<<G-2000SS>>		C 128	0620562	5600 pF 50V	3C			Adjusting VR	
		<<G-2000L, G-3000L>>				<<G-2000L, G-3000L>>		VR03	1035150	22 kΩ (B) FM Signal Meter	2C
IC 01	0360350	HA1137W } IC	2C	L 01	4200720	Antenna Coil (FM)	3D	VR04	1035110	Adjusting VR	2C
IC 02	0360320	HA1196 }	1C	L 02	4210340	RF Coil		S 01	1131060, 1	Push-Switch, FM Muting	2D
FT 01	0370172	2SK49 (H) FET	3B	L 03	4220420	O.S.C. Coil <<G-2000SS>>	2B	S 04	1103580	Rotary Switch, Selector	3C, D
					4220400	O.S.C. Coil		S 05	1110380	Slide Switch, (Bar-Ext)	
D 01 ~03	0311160	1S2473D Diode	2C, 3D	L 04	4900140	1 μH Inductor	2A			<<G-2000L, G-3000L>>	
ZD01	0315970	EQA01-13R Zener Diode		L 05	4290300	18 μH Inductor	2C	VC01	1220220	AM/FM Variable Capacitor	2, 3B
C 01, 03	0669347	12 pF 50V C.C.	3B, 2B	L 06	4290011	Peakng Coil 3.5 μH	2C	TC03	1230090	Trimmer Capacitor	2B
C 04	0669210	10 pF 50V C.C.	2A	L 07	4200740	Antenna Coil (AM)	3C	TC04 ~06	1230060	Trimmer Capacitor	3C
C 06	0669505	5 pF 50V C.C. <<G-2000SS>>	2A			<<G-2000L, G-3000L>>				<<G-2000SS, G-2000L>>	
	0669503	3 pF 50V C.C.		L 08	4200730	Antenna Coil	1A	TC07	1230060	Trimmer Capacitor <<G-2000L>>	3D
		<<G-2000L, G-3000L>>		L 09	4200620	Antenna Coil <<G-2000SS>>	3C	TC08	1230060	Trimmer Capacitor	3A
C 09	0679012	1.5 pF 500V	2B	L 10	4200630	Antenna Coil <<G-2000SS>>	3C	J 01	2090030	5P DIN Socket	1A
		Gimmick Capacitor			4230620	IF Coil <<G-2000L, G-3000L>>			2210330	4P Antenna Terminal	
C 10	0669372	12 pF 50V C.C.	2B	L 11	4900220	100 mH Inductor	2C		2230180	Ground Terminal	
		Gimmick Capacitor		L 12	4900110	100 μH Inductor	1C		2200410, 1	8P Input Terminal	
	0669355	20 pF 50V C.C.		L 13	4290011	3.5 x 10 ⁶ H Choke Coil				<<G-2000L only>>	
		<<G-2000L, G-3000L>>									

3. F-2825 Circuit Board for Signal Meter
(Stock No. 7521661, G-2000SS) (Stock No. 7521601, G-2000L)
(Stock No. 7521631, G-3000L)

Conductor Side



Parts List

Parts No.	Stock No.	Description
M 01	4301110, 1	Signal Meter

4. F-2826 Circuit Board for Tuning Meter
(Stock No. 7521671, G-2000SS) (Stock No. 7521611, G-2000L)
(Stock No. 7521641, G-3000L)

Conductor Side

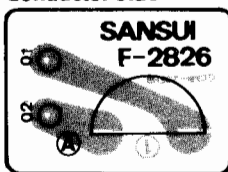

Parts List

Parts No.	Stock No.	Description
M 02	4301120, 1	Tuning Meter

5. F-2827 Circuit Board for Stereo Indicator
(Stock No. 7540831, G-2000SS) (Stock No. 7540821, G-2000L)
(Stock No. 7540841, G-3000L)

Conductor Side

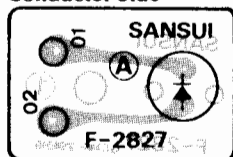

Parts List

Parts No.	Stock No.	Description
LD01	0319060	Light Emitted Diode

6. F-2712 Loudness Circuit Board
(Stock No. 7562051, G-2000SS) (Stock No. 7562041, G-2000L)
(Stock No. 7562061, G-3000L)

Conductor Side

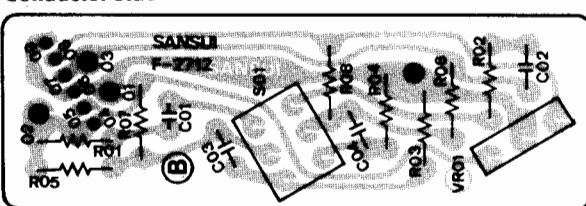

Parts List

Parts No.	Stock No.	Description
VR01	1005350, 1	250 kΩ (B) x 2 Balance Volume
S 01	1131490, 1	Push Switch, loudness

7. F-2713 Microphone Amp Circuit Board
(Stock No. 7610211, G-2000SS) (Stock No. 7610221, G-2000L)
(Stock No. 7610201, G-3000L)

Conductor Side

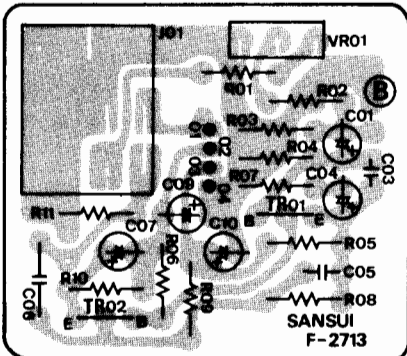

Parts List

Parts No.	Stock No.	Description
TR01	0300470, 1	2SA726W (F, G) Transistor
TR02	0306070, 1	2SC1313 (F, G) Transistor
VR01	1005340, 1	20 kΩ (A) Mixing Volume
J 01	2430370	Mic Jack Socket

8. F-2716 Voltage Selector Circuit Board
(Stock No. 7502691, G-2000SS only)

Conductor Side

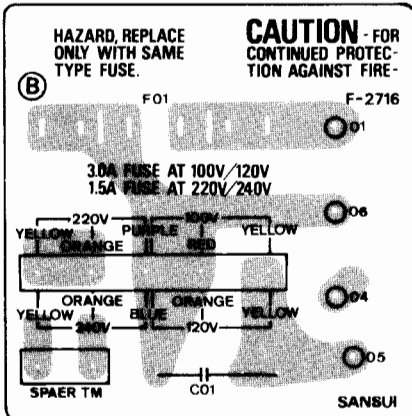

Parts List

Parts No.	Stock No.	Description
C 01	0659802	0.0047 μF 150V C.C.
F 01	0432230	1.5A 250V Fuse Holder
	2310220	

5. OTHER PARTS

<Front View>
<<G-3000L>>

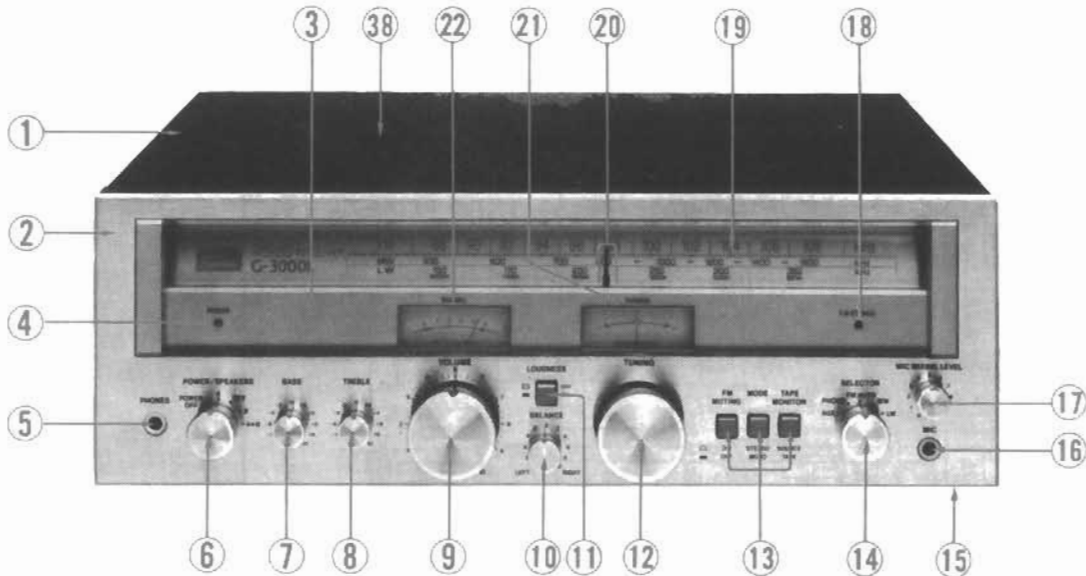

Parts List <<G-2000SS, G-2000L, G-3000L>>

Parts No.	Stock No.	Description	Parts No.	Stock No.	Description	Parts No.	Stock No.	Description
1	5727061	Wood Bonnet	14	5319140	Selector Switch Knob	34	7036540	Tuning Unit
	5236690	W.B Type Bushing		1103580	3-stage Rotary Switch			Washer
2	7007800	Front Panel Ass'y <<G-2000SS>>	15	5058792	Bottom Plate			Flywheel
	7007790	Front Panel Ass'y <<G-2000L>>		5517250	Leg			Tuning Shaft
	7007780	Front Panel Ass'y <<G-3000L>>	16	2430370	Microphone Jack Socket	35	7136100	Tension Unit
3	5305691	Inside Panel	17	5319130	Microphone Mixing Volume Knob	36	0400560	Pilot Lamp Ass'y
4	5426410	Power Illuminator Bar		1005340, 1	20 kΩ (A), Microphone	37	4002660	Power Transformer <<G-2000SS>>
5	2430380	Headphone Jack Socket			Mixing Volume		4002664	Power Transformer <<G-2000L>>
		<<G-2000SS, G-2000L>>	18	0319060	L.E.D. FM Stereo Indicator		4002654	Power Transformer <<G-3000L>>
		<<G-3000L>>		5289180	L.E.D. Holder	TR 15, 16	0308392, 3	2SD313 (E, F)
	2430370	Headphone Jack Socket		5136030	Plastic Rivet			<<G-2000SS, G-2000L>>
		<<G-3000L>>	19	5408260	Dial Scale <<G-2000SS>>		0306541, 2	2SC1986 (Q, Y)
6	5319140	Knob, power (8 speaker) switch		5408340	Dial Scale <<G-2000L>>			<<G-3000L>>
	1190530	Power Switch <<G-2000SS>>		5408250	Dial Scale <<G-3000L>>	TR 17, 18	0303232, 3	2SB507 (E, F)
	1190600	Power Switch <<G-2000L>>	20	7116031	Dial Pointer Ass'y			<<G-2000SS, G-2000L>>
	1101880	Power & Speaker Rotary Switch	21	4301120, 1	Tuning Meter		0300911, 2	2SA771 (Q, Y)
		<<G-3000L>>	22	4301110, 1	Signal Meter			<<G-3000L>>
7	5236470	M9 x 7, Spacer Nut	23	2450060	AC outlet <<G-2000SS only>>		5288721	Plate for the transistor
	5319130	BASS Volume Knob	24	3910600	AC Cord Clip <<G-2000SS>>	C 701	0605337	0.033 μF 250V M.C. <<G-2000SS>>
	1015300, 1	100 kΩ x 2 BASS Volume	25	3910490	AC Cord Clip <<G-2000L, G-3000L>>	C 701, 702	0598337	0.033 μF 250V M.P.
8	5319130	TREBLE Volume Knob		3800010, 4	AC Cord <<G-2000SS>>			<<G-2000L, G-3000L>>
	1015300, 1	100 kΩ x 2 TREBLE Volume		3800120, 1	AC Cord <<G-2000L, G-3000L>>	C 703	0659802	0.0047 μF 150V C.C.
9	5318980	Level Volume Knob	26	2210340	4P Speaker Terminal			<<G-2000L, G-3000L>>
	1011130, 1	250 kΩ (B) x 2 Level Volume	27	2090030	5P DIN Socket		1220220	AM-FM Variable Capacitor
10	5319130	BALANCE Volume Knob	28	2200410, 1	8P Input Terminal			
	1005350, 1	250 kΩ x 2 (B), BALANCE Volume	29	2230180	Ground Terminal			
11	5326690	Loudness Switch Knob	30	2210330	4P Antenna Terminal			
	1131490, 1	Loudness Switch	31	6146670	D-44 Type Pulley			
12	5318970	Tuning Knob	32	4200750	Bar Antenna <<G-2000L, G-3000L>>			
13	1131060, 1	3-gang Push Switch	33	5289170	Bar Antenna Holder			
	5326690	Knob, tape monitor, mode FM muting			<<G-2000L, G-3000L>>			

• Abbreviations

C.R. : Carbon Resistor	E.C. : Electrolytic Capacitor
S.R. : Solid Resistor	BP.E.C. : Bi-Polar Electrolytic Capacitor
Ce.R. : Cement Resistor	C.C. : Ceramic Capacitor
M.R. : Metal Film Resistor	Mi.C. : Mica Capacitor
F.R. : Fusing Resistor	O.C. : Oil Capacitor
N.I.R. : Non-Inflammable Resistor	P.C. : Polystyrene Capacitor
M.C. : Mylar Capacitor	E.C. : Tantalum Capacitor

<Top View>
<<G-3000L>>

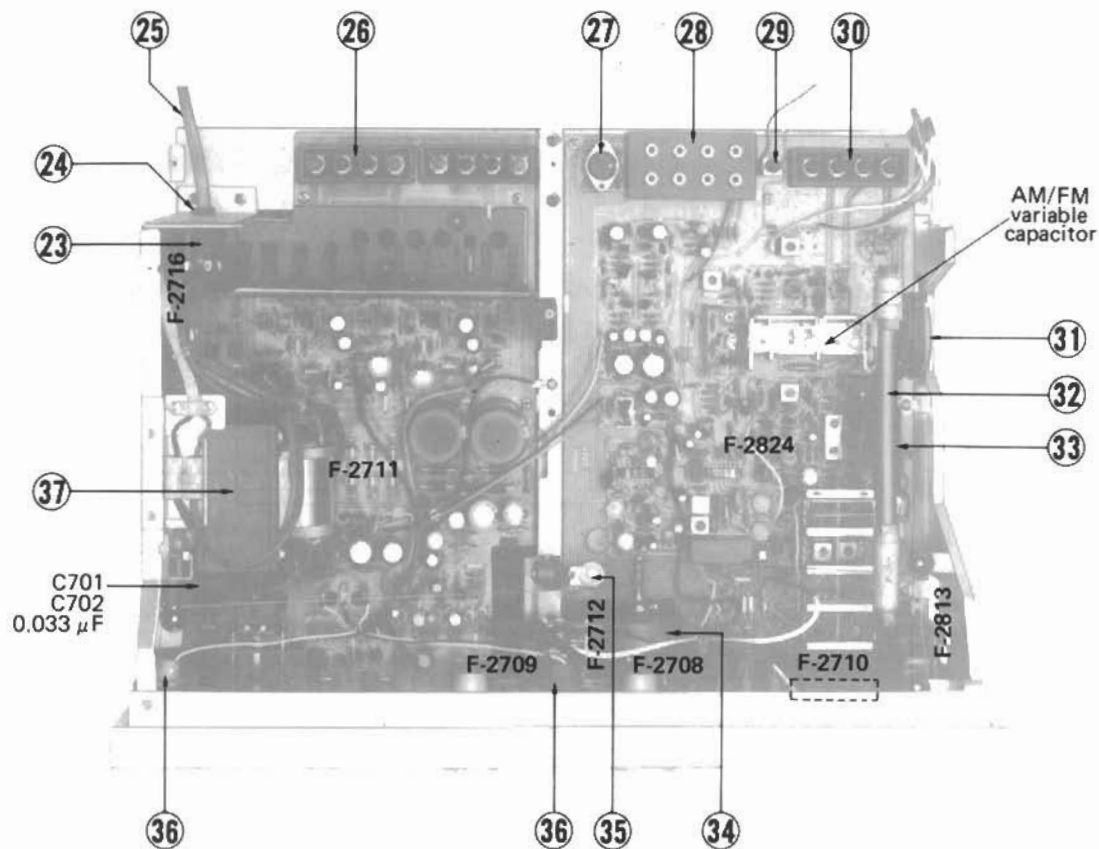

6. PARTS REPLACEMENT

1. Square Knobs of Loudness, FM Muting, Mode & Tape Monitor

1. Take off a wood bonnet, front & inside panels.
2. Then, pull out knobs to which are not glued as Fig. 1.

2. Tuning & Signal Meter

1. Complete 1. & 2. above.
2. Take off the meter as Fig. 2, then put it back into same place until snapped.

Fig. 1

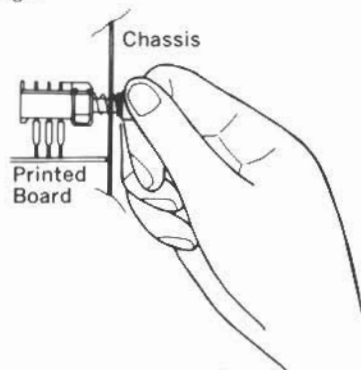
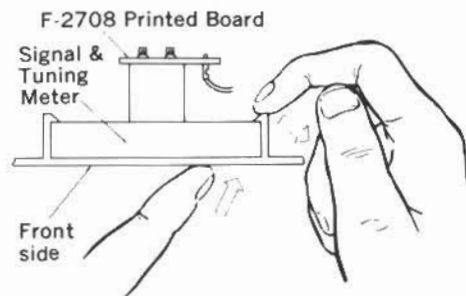

Fig. 2



3. Level Volume

1. Take off the two panels and one nut for level volume.
2. Then, unsolder six points installing the level volume on pattern side of F-2711 printed board.

Fig. 3 Level Volume
(Bottom side) Soldering points

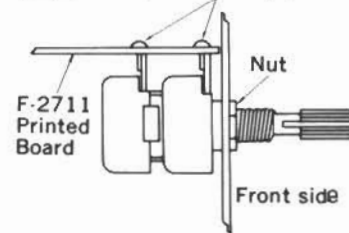

A B C D

7. SCHEMATIC DIAGRAM ◀G-2000SS▶

- SWITCHES & CONTROLS**
- POWER SW 1. on
 - LOUDNESS SW 1. on
 - F-2712 1. on
 - F-2711 2. on
 - F-2710 3. on
 - F-2709 4. on
 - F-2708 5. on
 - F-2707 6. on
 - F-2706 7. on
 - F-2705 8. on
 - F-2704 9. on
 - F-2703 10. on
 - F-2702 11. on
 - F-2701 12. on
 - F-2700 13. on
 - F-2699 14. on
 - F-2698 15. on
 - F-2697 16. on
 - F-2696 17. on
 - F-2695 18. on
 - F-2694 19. on
 - F-2693 20. on
 - F-2692 21. on
 - F-2691 22. on
 - F-2690 23. on
 - F-2689 24. on
 - F-2688 25. on
 - F-2687 26. on
 - F-2686 27. on
 - F-2685 28. on
 - F-2684 29. on
 - F-2683 30. on
 - F-2682 31. on
 - F-2681 32. on
 - F-2680 33. on
 - F-2679 34. on
 - F-2678 35. on
 - F-2677 36. on
 - F-2676 37. on
 - F-2675 38. on
 - F-2674 39. on
 - F-2673 40. on
 - F-2672 41. on
 - F-2671 42. on
 - F-2670 43. on
 - F-2669 44. on
 - F-2668 45. on
 - F-2667 46. on
 - F-2666 47. on
 - F-2665 48. on
 - F-2664 49. on
 - F-2663 50. on
 - F-2662 51. on
 - F-2661 52. on
 - F-2660 53. on
 - F-2659 54. on
 - F-2658 55. on
 - F-2657 56. on
 - F-2656 57. on
 - F-2655 58. on
 - F-2654 59. on
 - F-2653 60. on
 - F-2652 61. on
 - F-2651 62. on
 - F-2650 63. on
 - F-2649 64. on
 - F-2648 65. on
 - F-2647 66. on
 - F-2646 67. on
 - F-2645 68. on
 - F-2644 69. on
 - F-2643 70. on
 - F-2642 71. on
 - F-2641 72. on
 - F-2640 73. on
 - F-2639 74. on
 - F-2638 75. on
 - F-2637 76. on
 - F-2636 77. on
 - F-2635 78. on
 - F-2634 79. on
 - F-2633 80. on
 - F-2632 81. on
 - F-2631 82. on
 - F-2630 83. on
 - F-2629 84. on
 - F-2628 85. on
 - F-2627 86. on
 - F-2626 87. on
 - F-2625 88. on
 - F-2624 89. on
 - F-2623 90. on
 - F-2622 91. on
 - F-2621 92. on
 - F-2620 93. on
 - F-2619 94. on
 - F-2618 95. on
 - F-2617 96. on
 - F-2616 97. on
 - F-2615 98. on
 - F-2614 99. on
 - F-2613 100. on
 - F-2612 101. on
 - F-2611 102. on
 - F-2610 103. on
 - F-2609 104. on
 - F-2608 105. on
 - F-2607 106. on
 - F-2606 107. on
 - F-2605 108. on
 - F-2604 109. on
 - F-2603 110. on
 - F-2602 111. on
 - F-2601 112. on
 - F-2600 113. on
 - F-2599 114. on
 - F-2598 115. on
 - F-2597 116. on
 - F-2596 117. on
 - F-2595 118. on
 - F-2594 119. on
 - F-2593 120. on
 - F-2592 121. on
 - F-2591 122. on
 - F-2590 123. on
 - F-2589 124. on
 - F-2588 125. on
 - F-2587 126. on
 - F-2586 127. on
 - F-2585 128. on
 - F-2584 129. on
 - F-2583 130. on
 - F-2582 131. on
 - F-2581 132. on
 - F-2580 133. on
 - F-2579 134. on
 - F-2578 135. on
 - F-2577 136. on
 - F-2576 137. on
 - F-2575 138. on
 - F-2574 139. on
 - F-2573 140. on
 - F-2572 141. on
 - F-2571 142. on
 - F-2570 143. on
 - F-2569 144. on
 - F-2568 145. on
 - F-2567 146. on
 - F-2566 147. on
 - F-2565 148. on
 - F-2564 149. on
 - F-2563 150. on
 - F-2562 151. on
 - F-2561 152. on
 - F-2560 153. on
 - F-2559 154. on
 - F-2558 155. on
 - F-2557 156. on
 - F-2556 157. on
 - F-2555 158. on
 - F-2554 159. on
 - F-2553 160. on
 - F-2552 161. on
 - F-2551 162. on
 - F-2550 163. on
 - F-2549 164. on
 - F-2548 165. on
 - F-2547 166. on
 - F-2546 167. on
 - F-2545 168. on
 - F-2544 169. on
 - F-2543 170. on
 - F-2542 171. on
 - F-2541 172. on
 - F-2540 173. on
 - F-2539 174. on
 - F-2538 175. on
 - F-2537 176. on
 - F-2536 177. on
 - F-2535 178. on
 - F-2534 179. on
 - F-2533 180. on
 - F-2532 181. on
 - F-2531 182. on
 - F-2530 183. on
 - F-2529 184. on
 - F-2528 185. on
 - F-2527 186. on
 - F-2526 187. on
 - F-2525 188. on
 - F-2524 189. on
 - F-2523 190. on
 - F-2522 191. on
 - F-2521 192. on
 - F-2520 193. on
 - F-2519 194. on
 - F-2518 195. on
 - F-2517 196. on
 - F-2516 197. on
 - F-2515 198. on
 - F-2514 199. on
 - F-2513 200. on
 - F-2512 201. on
 - F-2511 202. on
 - F-2510 203. on
 - F-2509 204. on
 - F-2508 205. on
 - F-2507 206. on
 - F-2506 207. on
 - F-2505 208. on
 - F-2504 209. on
 - F-2503 210. on
 - F-2502 211. on
 - F-2501 212. on
 - F-2500 213. on
 - F-2499 214. on
 - F-2498 215. on
 - F-2497 216. on
 - F-2496 217. on
 - F-2495 218. on
 - F-2494 219. on
 - F-2493 220. on
 - F-2492 221. on
 - F-2491 222. on
 - F-2490 223. on
 - F-2489 224. on
 - F-2488 225. on
 - F-2487 226. on
 - F-2486 227. on
 - F-2485 228. on
 - F-2484 229. on
 - F-2483 230. on
 - F-2482 231. on
 - F-2481 232. on
 - F-2480 233. on
 - F-2479 234. on
 - F-2478 235. on
 - F-2477 236. on
 - F-2476 237. on
 - F-2475 238. on
 - F-2474 239. on
 - F-2473 240. on
 - F-2472 241. on
 - F-2471 242. on
 - F-2470 243. on
 - F-2469 244. on
 - F-2468 245. on
 - F-2467 246. on
 - F-2466 247. on
 - F-2465 248. on
 - F-2464 249. on
 - F-2463 250. on
 - F-2462 251. on
 - F-2461 252. on
 - F-2460 253. on
 - F-2459 254. on
 - F-2458 255. on
 - F-2457 256. on
 - F-2456 257. on
 - F-2455 258. on
 - F-2454 259. on
 - F-2453 260. on
 - F-2452 261. on
 - F-2451 262. on
 - F-2450 263. on
 - F-2449 264. on
 - F-2448 265. on
 - F-2447 266. on
 - F-2446 267. on
 - F-2445 268. on
 - F-2444 269. on
 - F-2443 270. on
 - F-2442 271. on
 - F-2441 272. on
 - F-2440 273. on
 - F-2439 274. on
 - F-2438 275. on
 - F-2437 276. on
 - F-2436 277. on
 - F-2435 278. on
 - F-2434 279. on
 - F-2433 280. on
 - F-2432 281. on
 - F-2431 282. on
 - F-2430 283. on
 - F-2429 284. on
 - F-2428 285. on
 - F-2427 286. on
 - F-2426 287. on
 - F-2425 288. on
 - F-2424 289. on
 - F-2423 290. on
 - F-2422 291. on
 - F-2421 292. on
 - F-2420 293. on
 - F-2419 294. on
 - F-2418 295. on
 - F-2417 296. on
 - F-2416 297. on
 - F-2415 298. on
 - F-2414 299. on
 - F-2413 300. on
 - F-2412 301. on
 - F-2411 302. on
 - F-2410 303. on
 - F-2409 304. on
 - F-2408 305. on
 - F-2407 306. on
 - F-2406 307. on
 - F-2405 308. on
 - F-2404 309. on
 - F-2403 310. on
 - F-2402 311. on
 - F-2401 312. on
 - F-2400 313. on
 - F-2399 314. on
 - F-2398 315. on
 - F-2397 316. on
 - F-2396 317. on
 - F-2395 318. on
 - F-2394 319. on
 - F-2393 320. on
 - F-2392 321. on
 - F-2391 322. on
 - F-2390 323. on
 - F-2389 324. on
 - F-2388 325. on
 - F-2387 326. on
 - F-2386 327. on
 - F-2385 328. on
 - F-2384 329. on
 - F-2383 330. on
 - F-2382 331. on
 - F-2381 332. on
 - F-2380 333. on
 - F-2379 334. on
 - F-2378 335. on
 - F-2377 336. on
 - F-2376 337. on
 - F-2375 338. on
 - F-2374 339. on
 - F-2373 340. on
 - F-2372 341. on
 - F-2371 342. on
 - F-2370 343. on
 - F-2369 344. on
 - F-2368 345. on
 - F-2367 346. on
 - F-2366 347. on
 - F-2365 348. on
 - F-2364 349. on
 - F-2363 350. on
 - F-2362 351. on
 - F-2361 352. on
 - F-2360 353. on
 - F-2359 354. on
 - F-2358 355. on
 - F-2357 356. on
 - F-2356 357. on
 - F-2355 358. on
 - F-2354 359. on
 - F-2353 360. on
 - F-2352 361. on
 - F-2351 362. on
 - F-2350 363. on
 - F-2349 364. on
 - F-2348 365. on
 - F-2347 366. on
 - F-2346 367. on
 - F-2345 368. on
 - F-2344 369. on
 - F-2343 370. on
 - F-2342 371. on
 - F-2341 372. on
 - F-2340 373. on
 - F-2339 374. on
 - F-2338 375. on
 - F-2337 376. on
 - F-2336 377. on
 - F-2335 378. on
 - F-2334 379. on
 - F-2333 380. on
 - F-2332 381. on
 - F-2331 382. on
 - F-2330 383. on
 - F-2329 384. on
 - F-2328 385. on
 - F-2327 386. on
 - F-2326 387. on
 - F-2325 388. on
 - F-2324 389. on
 - F-2323 390. on
 - F-2322 391. on
 - F-2321 392. on
 - F-2320 393. on
 - F-2319 394. on
 - F-2318 395. on
 - F-2317 396. on
 - F-2316 397. on
 - F-2315 398. on
 - F-2314 399. on
 - F-2313 400. on
 - F-2312 401. on
 - F-2311 402. on
 - F-2310 403. on
 - F-2309 404. on
 - F-2308 405. on
 - F-2307 406. on
 - F-2306 407. on
 - F-2305 408. on
 - F-2304 409. on
 - F-2303 410. on
 - F-2302 411. on
 - F-2301 412. on
 - F-2300 413. on
 - F-2299 414. on
 - F-2298 415. on
 - F-2297 416. on
 - F-2296 417. on
 - F-2295 418. on
 - F-2294 419. on
 - F-2293 420. on
 - F-2292 421. on
 - F-2291 422. on
 - F-2290 423. on
 - F-2289 424. on
 - F-2288 425. on
 - F-2287 426. on
 - F-2286 427. on
 - F-2285 428. on
 - F-2284 429. on
 - F-2283 430. on
 - F-2282 431. on
 - F-2281 432. on
 - F-2280 433. on
 - F-2279 434. on
 - F-2278 435. on
 - F-2277 436. on
 - F-2276 437. on
 - F-2275 438. on
 - F-2274 439. on
 - F-2273 440. on
 - F-2272 441. on
 - F-2271 442. on
 - F-2270 443. on
 - F-2269 444. on
 - F-2268 445. on
 - F-2267 446. on
 - F-2266 447. on
 - F-2265 448. on
 - F-2264 449. on
 - F-2263 450. on
 - F-2262 451. on
 - F-2261 452. on
 - F-2260 453. on
 - F-2259 454. on
 - F-2258 455. on
 - F-2257 456. on
 - F-2256 457. on
 - F-2255 458. on
 - F-2254 459. on
 - F-2253 460. on
 - F-2252 461. on
 - F-2251 462. on
 - F-2250 463. on
 - F-2249 464. on
 - F-2248 465. on
 - F-2247 466. on
 - F-2246 467. on
 - F-2245 468. on
 - F-2244 469. on
 - F-2243 470. on
 - F-2242 471. on
 - F-2241 472. on
 - F-2240 473. on
 - F-2239 474. on
 - F-2238 475. on
 - F-2237 476. on
 - F-2236 477. on
 - F-2235 478. on
 - F-2234 479. on
 - F-2233 480. on
 - F-2232 481. on
 - F-2231 482. on
 - F-2230 483. on
 - F-2229 484. on
 - F-2228 485. on
 - F-2227 486. on
 - F-2226 487. on
 - F-2225 488. on
 - F-2224 489. on
 - F-2223 490. on
 - F-2222 491. on
 - F-2221 492. on
 - F-2220 493. on
 - F-2219 494. on
 - F-2218 495. on
 - F-2217 496. on
 - F-2216 497. on
 - F-2215 498. on
 - F-2214 499. on
 - F-2213 500. on
 - F-2212 501. on
 - F-2211 502. on
 - F-2210 503. on
 - F-2209 504. on
 - F-2208 505. on
 - F-2207 506. on
 - F-2206 507. on
 - F-2205 508. on
 - F-2204 509. on
 - F-2203 510. on
 - F-2202 511. on
 - F-2201 512. on
 - F-2200 513. on
 - F-2199 514. on
 - F-2198 515. on
 - F-2197 516. on
 - F-2196 517. on
 - F-2195 518. on
 - F-2194 519. on
 - F-2193 520. on
 - F-2192 521. on
 - F-2191 522. on
 - F-2190 523. on
 - F-2189 524. on
 - F-2188 525. on
 - F-2187 526. on
 - F-2186 527. on
 - F-2185 528. on
 - F-2184 529. on
 - F-2183 530. on
 - F-2182 531. on
 - F-2181 532. on
 - F-2180 533. on
 - F-2179 534. on
 - F-2178 535. on
 - F-2177 536. on
 - F-2176 537. on
 - F-2175 538. on
 - F-2174 539. on
 - F-2173 540. on
 - F-2172 541. on
 - F-2171 542. on
 - F-2170 543. on
 - F-2169 544. on
 - F-2168 545. on
 - F-2167 546. on
 - F-2166 547. on
 - F-2165 548. on
 - F-2164 549. on
 - F-2163 550. on
 - F-2162 551. on
 - F-2161 552. on
 - F-2160 553. on
 - F-2159 554. on
 - F-2158 555. on
 - F-2157 556. on
 - F-2156 557. on
 - F-2155 558. on
 - F-2154 559. on
 - F-2153 560. on
 - F-2152 561. on
 - F-2151 562. on
 - F-2150 563. on
 - F-2149 564. on
 - F-2148 565. on
 - F-2147 566. on
 - F-2146 567. on
 - F-2145 568. on
 - F-2144 569. on
 - F-2143 570. on
 - F-2142 571. on
 - F-2141 572. on
 - F-2140 573. on
 - F-2139 574. on
 - F-2138 575. on
 - F-2137 576. on
 - F-2136 577. on
 - F-2135 578. on
 - F-2134 579. on
 - F-2133 580. on
 - F-2132 581. on
 - F-2131 582. on
 - F-2130 583. on
 - F-2129 584. on
 - F-2128 585. on
 - F-2127 586. on
 - F-2126 587. on
 - F-2125 588. on
 - F-2124 589. on
 - F-2123 590. on
 - F-2122 591. on
 - F-2121 592. on
 - F-2120 593. on
 - F-2119 594. on
 - F-2118 595. on
 - F-2117 596. on
 - F-2116 597. on
 - F-2115 598. on
 - F-2114 599. on
 - F-2113 600. on
 - F-2112 601. on
 - F-2111 602. on
 - F-2110 603. on
 - F-2109 604. on
 - F-2108 605. on
 - F-2107 606. on
 - F-2106 607. on
 - F-2105 608. on
 - F-2104 609. on
 - F-2103 610. on
 - F-2102 611. on
 - F-2101 612. on
 - F-2100 613. on
 - F-2099 614. on
 - F-2098 615. on
 - F-2097 616. on
 - F-2096 617. on
 - F-2095 618. on
 - F-2094 619. on
 - F-2093 620. on
 - F-2092 621. on
 - F-2091 622. on
 - F-2090 623. on
 - F-2089 624. on
 - F-2088 625. on
 - F-2087 626. on
 - F-2086 627. on
 - F-2085 628. on
 - F-2084 629. on
 - F-2083 630. on
 - F-2082 631. on
 - F-2081 632. on
 - F-2080 633. on
 - F-2079 634. on
 - F-2078 635. on
 - F-2077 636. on
 - F-2076 637. on
 - F-2075 638. on
 - F-2074 639. on
 - F-2073 640. on
 - F-2072 641. on
 - F-2071 642. on
 - F-2070 643. on
 - F-2069 644. on
 - F-2068 645. on
 - F-2067 646. on
 - F-2066 647. on
 - F-2065 648. on
 - F-2064 649. on
 - F-2063 650. on
 - F-2062 651. on
 - F-2061 652. on
 - F-2060 653. on
 - F-2059 654. on
 - F-2058 655. on
 - F-2057 656. on
 - F-2056 657. on
 - F-2055 658. on
 - F-2054 659. on
 - F-2053 660. on
 - F-2052 661. on
 - F-2051 662. on
 - F-2050 663. on
 - F-2049 664. on
 - F-2048 665. on
 - F-2047 666. on
 - F-2046 667. on
 - F-2045 668. on
 - F-2044 669. on
 - F-2043 670. on
 - F-2042 671. on
 - F-2041 672. on
 - F-2040 673. on
 - F-2039 674. on
 - F-2038 675. on
 - F-2037 676. on
 - F-2036 677. on
 - F-2035 678. on
 - F-2034 679. on
 - F-2033 680. on
 - F-2032 681. on
 - F-2031 682. on
 - F-2030 683. on
 - F-2029 684. on
 - F-2028 685. on
 - F-2027 686. on
 - F-2026 687. on
 - F-2025 688. on
 - F-2024 689. on
 - F-2023 690. on
 - F-2022 691. on
 - F-2021 692. on
 - F-2020 693. on
 - F-2019 694. on
 - F-2018 695. on
 - F-2017 696. on
 - F-2016 697. on
 - F-2015 698. on
 - F-2014 699. on
 - F-2013 700. on
 - F-2012 701. on
 - F-2011 702. on
 - F-2010 703. on
 - F-2009 704. on
 - F-2008 705. on
 - F-2007 706. on
 - F-2006 707. on
 - F-2005 708. on
 - F-2004 709. on
 - F-2003 710. on
 - F-2002 711. on
 - F-2001 712. on
 - F-2000 713. on
 - F-1999 714. on
 - F-1998 715. on
 - F-1997 716. on
 - F-1996 717. on
 - F-1995 718. on
 - F-1994 719. on
 - F-1993 720. on</

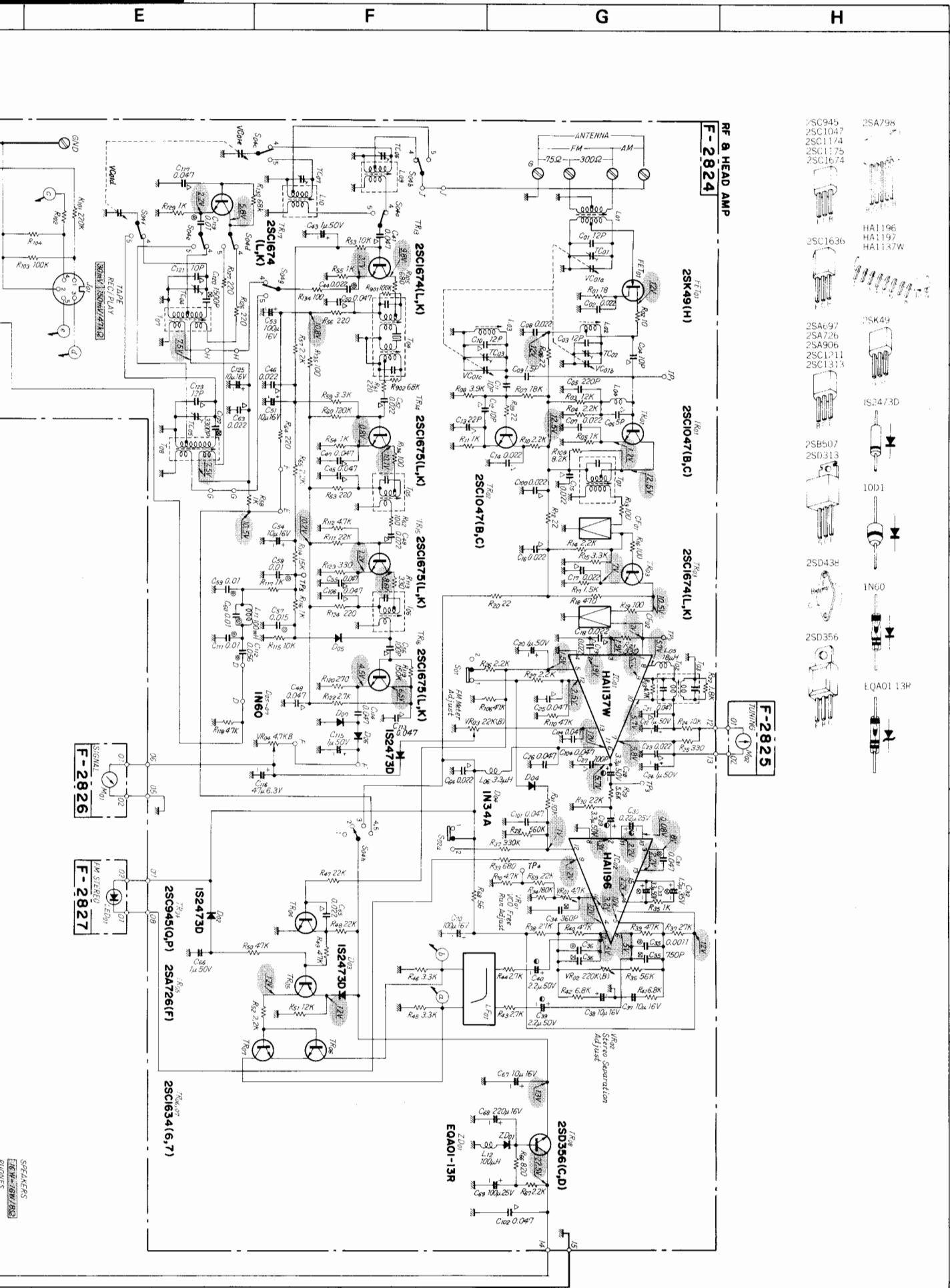

1

2

3

4

5

- 2SC945
- 2SC1047
- 2SC1174
- 2SC1175
- 2SC1674
- 2SC1636
- 2SC1674(L,K)
- 2SC1675(L,K)
- 2SC1676(L,K)
- 2SC1677(L,K)
- 2SC1678(L,K)
- 2SC1679(L,K)
- 2SC1047(B,C)
- 2SC1047(B,C)
- 2SC1674(L,K)
- 2SC1679(L,K)
- 2SC1679(L,K)
- 2SD313
- 2SB507
- 2SD313
- 2SD43R
- 2SD356
- 2SA798
- HA1196
- HA1197
- HA1147W
- 2SK49
- IS2473D
- 1001
- IN60
- EOA01-13R

F-2926

F-2927

F-2925

SPEAKERS
EQA01-13R

◀G-2000▶

- SWITCHES & CONTROLS**
- POWER Sw1 1, off
 - LOUDNESS F-2712 1, off
 - FM MUTING F-2712 2, on
 - MODE F-289A 1, on
 - MODE F-289A 2, off
 - MODE F-289A 3, stereo
 - TAPE F-289A 1, mono
 - TAPE F-289A 2, stereo
 - SELECTOR F-289A 1, auto
 - SELECTOR F-289A 2, phono
 - SELECTOR F-289A 3, FM
 - SELECTOR F-289A 4, MW
 - SELECTOR F-289A 5, LW
 - SELECTOR F-289A 6, EXT
- SYMBOLS**
- ⊕ Schematic
 - ⊖ Mute
 - ⊕ Alternating Electrolytic
 - ⊖ Bi-polar Electrolytic
 - ⊕ Electrolytic
 - ⊖ Non-Electrolytic
 - ⊕ Resistor
 - ⊖ Non-Tolerant Resistor
- RESISTORS**
- Are in ohms, % unless .5% tolerance unless otherwise noted. K=K, M=M.
- CAPACITORS**
- Are in pF unless otherwise noted. p=pF.
- TOLERANCE**
- J = ±.5%, G = ±2%, F = ±1%
- Each DC voltage shows the nominal value in volts at no input signal.

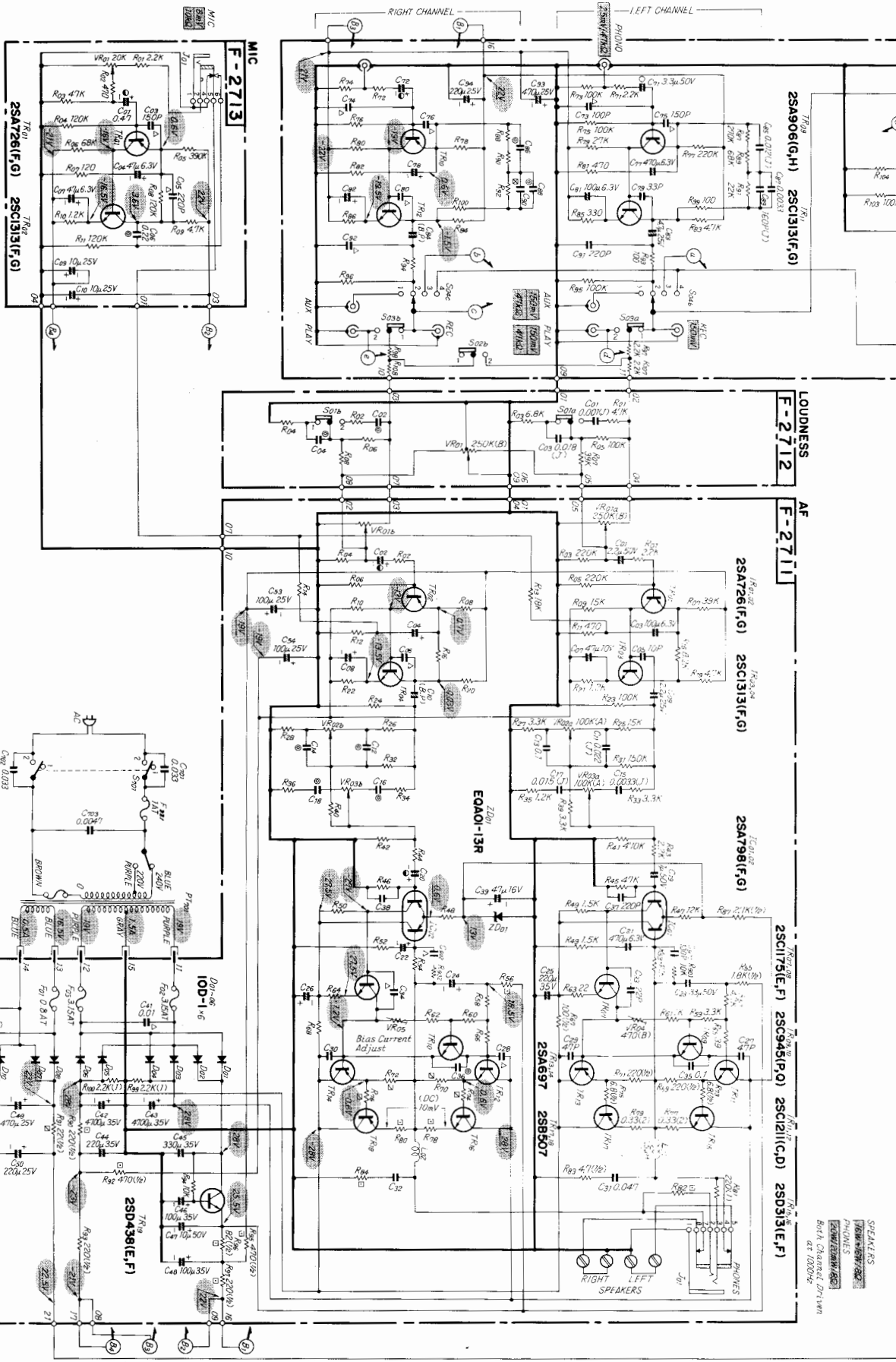

SPEAKERS
PHONES
Both Channels Driven at 1000Hz

←G-3000L→

A B C D

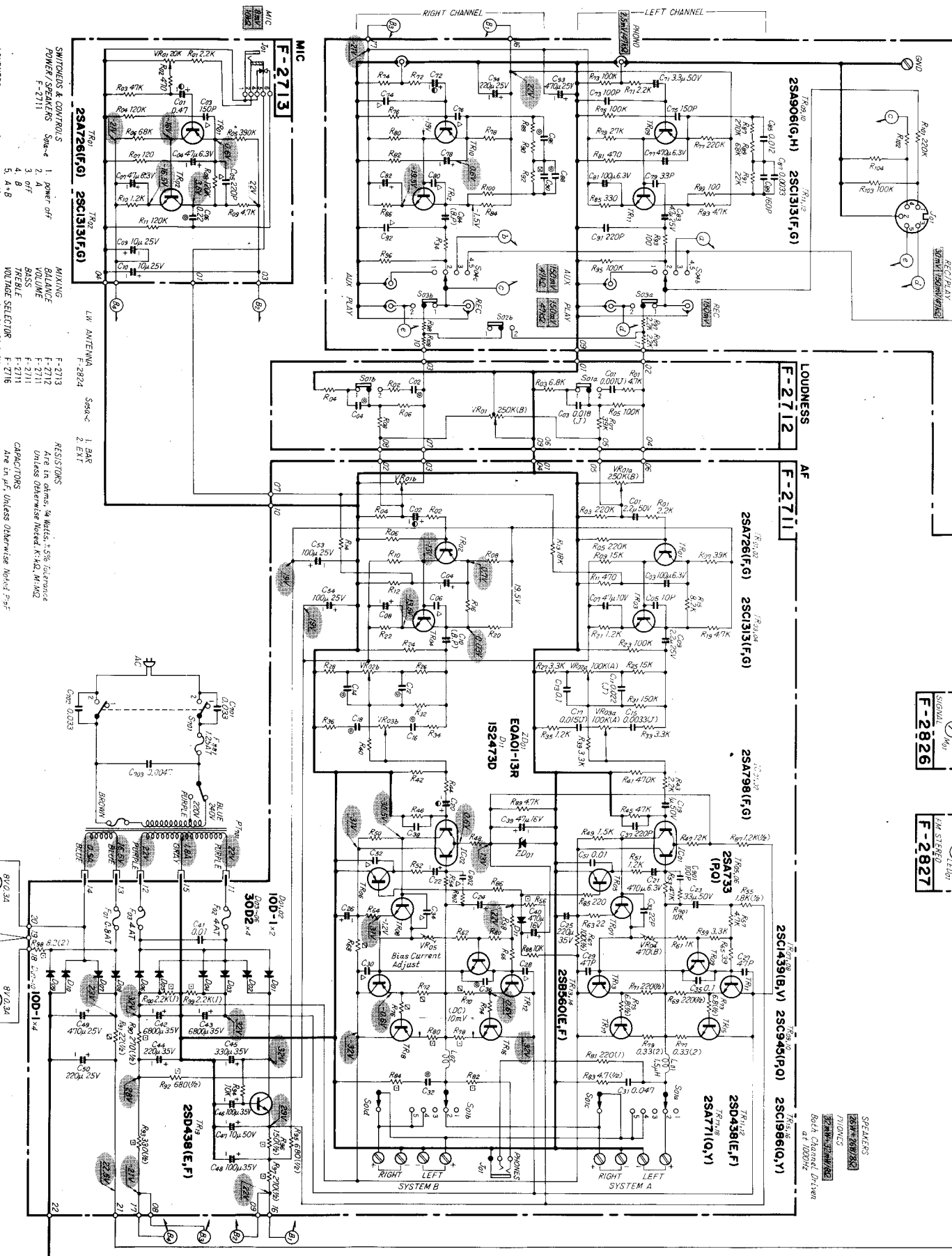

- SWITCHES & CONTROLS**
- POWER/SPEAKERS F-2711
 - LOUDNESS F-2712
 - FM MUTING F-2824
 - MODE F-2824
 - TAPE MONITOR F-2824
 - SELECTOR F-2824
- SYMBOLS**
- △ Ceramic
 - ⊗ Mylar
 - ⊗ Styrol
 - ⊗ Aluminum Electrolytic
 - ⊗ Polystyrene Electrolytic
 - ⊗ Fusing Resistor
 - ⊗ Non-Inflammable Resistor

- MIXING**
- 1. power off
 - 2. A
 - 3. off
 - 4. B
 - 5. A+B
- BALANCE**
- 1. stereo
 - 2. mono
- VOLUME**
- 1. source
 - 2. tape
 - 3. stereo
 - 4. FM
 - 5. LW
- TREBLE**
- 1. off
 - 2. on
- BASS**
- 1. off
 - 2. on
- TONE SELECTOR**
- 1. BAR
 - 2. EXT
- RESISTORS**
- Are in ohms, % unless ±5% tolerance
 - Unless otherwise noted, M, K, W, Ω
- CAPACITORS**
- Are in μf. Unless otherwise noted, P, nF
- TOLERANCE**
- J: ±5% G: ±2% F: ±1%
- Each DC Voltage shows the nominal voltage in volts ± no input signal.

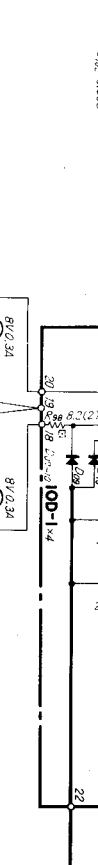

SPEAKERS
16Ω STEREO
PHONES
Both Channels Driven
at 1000Hz

8. THREADING OF DIAL CORD

- * If a dial cord is cut off or slips, replace it by following procedures.
As this unit uses 0.5 mm ϕ cord, please replace it with the same type certainly.
- * The length of dial cord is approximately 160 cm (65.3 inch).

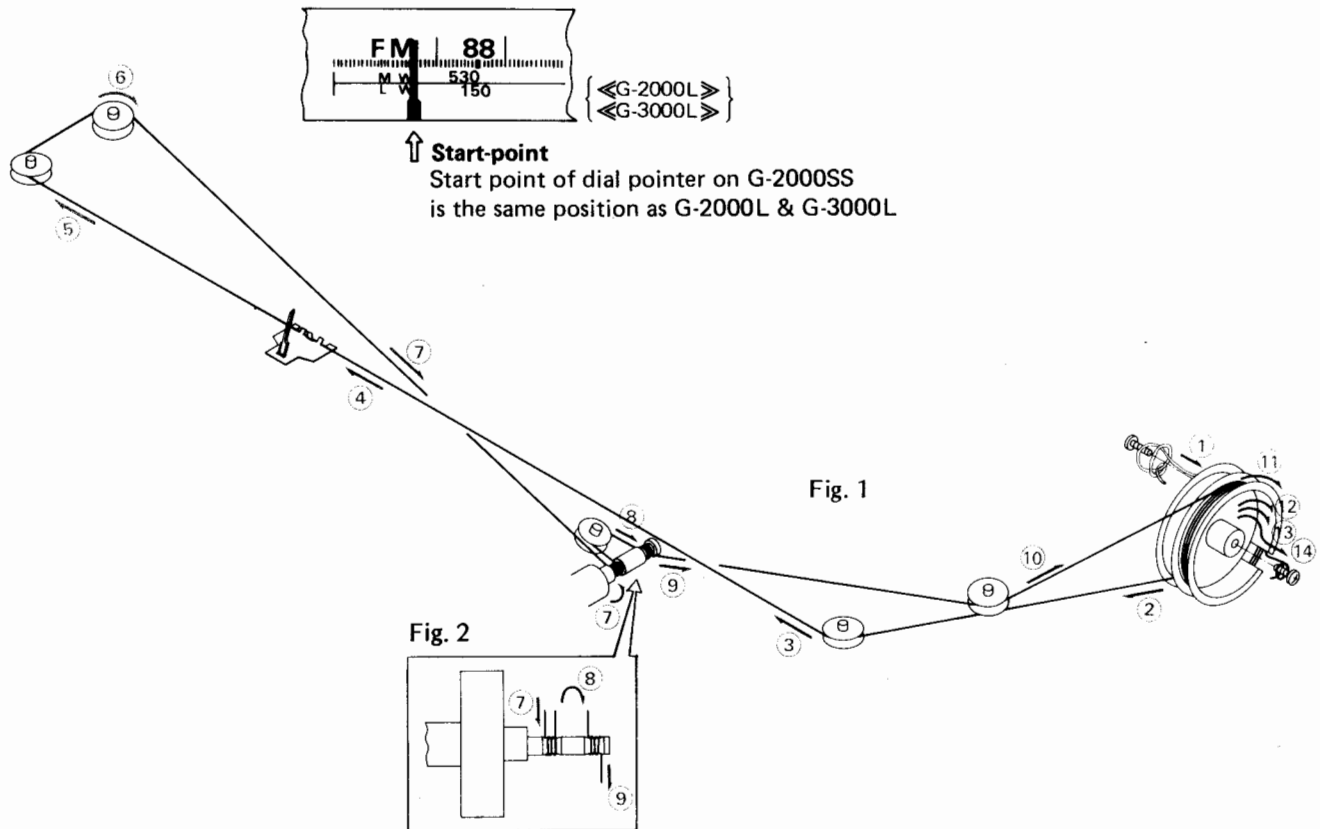

Threading of Dial Cord

Thread the dial cord in numerical order from 1 to 14 as Fig. 1.
* Close the variable capacitor completely (Maximum Capacitance).

Attachment of Dial Pointer

- 1) Close the variable capacitor completely.
 - 2) Set the dial pointer to start point on dial scale as Fig. 2.
- * Confirm that the dial pointer runs smoothly on the dial scale by turning the turning shaft.

Stock No.	Description
6036050	Dial Cord (0.5 mm ϕ)
6146670	Dial Pulley

9. PACKING LIST

Parts No.	Stock No.	Description
1	9116143	Vinyl Cover
2	9028090	Stylofoam Packing
3	9009960	Carton Case <<G-2000SS>>
	9009970	Carton Case <<G-2000L>>
	9009940	Carton Case <<G-3000L>>
4	5996080	Curl Stopper

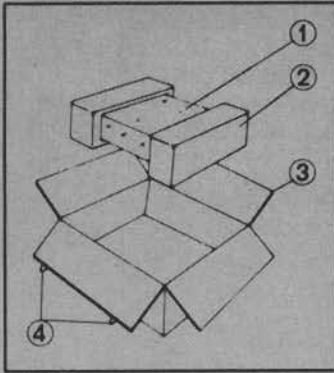

10. ACCESSORY PARTS LIST

Stock No.	Description
9203370	Operating Instructions <<G-2000SS>>
9203360	Operating Instructions <<G-2000L>>
9203350	Operating Instructions <<G-3000L>>
9237690	Schematic Diagram <<G-2000SS>>
9237680	Schematic Diagram <<G-2000L>>
9237670	Schematic Diagram <<G-3000L>>
3820100	FM Antenna

Sansui

SANSUI ELECTRONICS CORPORATION: 55-11 Queens Blvd. Woodside, N.Y. 11377 U.S.A.
333 West Alondra Blvd. Gardena, California 90247 U.S.A.
3036 Koapaka St. Honolulu, Hawaii 96819 U.S.A.

SANSUI AUDIO EUROPE N.V.: North Trade Bldg (9th floor) Noorderlaan 133-Bus 1,2030 Antwerp, Belgium
SANSUI AUDIO EUROPE S.A.: Arabella center, 6 Frankfurt AM Main, Lyoner Strasse 44-48, West Germany

SANSUI ELECTRIC COMPANY LTD.: 14-1, Izumi 2-chome, Suginamiku, Tokyo 168 Japan PHONE: (03) 323-1111/TELEX:232-2076