

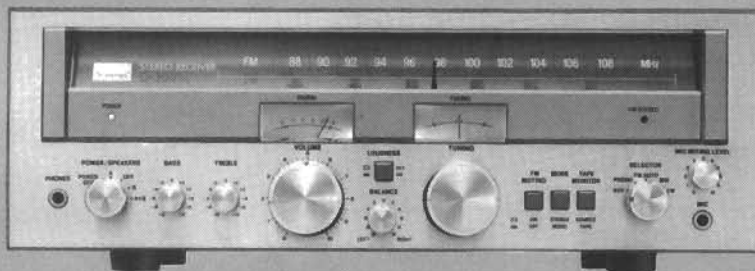

SERVICE MANUAL

STEREO RECEIVER

SANSUI G-2000SS/2000L G-3000L



SPECIFICATIONS

Audio Section

◀G-2000SS, G-2000L▶

Power output

Min. RMS, both channels driven, from 20 to 20,000 Hz,
with no more than 0.15% total harmonic distortion
16 watts per channel into 8 ohms
Load impedance 8 ohms
Total harmonic distortion

. less than 0.15% at or below
rated min. RMS power output

Intermodulation distortion (70 Hz : 7 kHz = 4:1 SMPTE
method) less than 0.15%

Frequency response (at 1 watt)

. 10 to 50,000 Hz +1 dB -2 dB

RIAA curve deviation (PHONO)

. +0.5 dB -0.5 dB
(30 to 15,000 Hz)

Damping factor approximately 30 at 8-ohms
load

Input sensitivity and impedance (1 kHz, for rated power
output)

PHONO 2.5 mV/47 kilohms
(Max. input capability; 190 mV at 1 kHz, less than
0.5% total harmonic distortion)

AUX, TAPE 150 mV/47 kilohms

MIC 8 mV/10 kilohms

Output level (1 kHz)

TAPE REC (pin jack) 150 mV/47 kilohms
(DIN) 43 mV

Channel separation (1 kHz, at rated power output)

PHONO better than 50 dB

AUX better than 50 dB

Hum and noise (short-circuit, A network)

PHONO 75 dB

AUX 95 dB

Controls

BASS ±10 dB (50 Hz)

TREBLE ±10 dB (10 kHz)

LOUDNESS (-30 dB)

. 7 dB at 50 Hz

. 5 dB at 10 kHz

◀G-3000L▶

Power output

Min. RMS, both channels driven, from 20 to 20,000 Hz,
with no more than 0.15% total harmonic distortion
26 watts per channel into 8 ohms
26 watts per channel into 4 ohms
Load impedance 4 and 8 ohms
Total harmonic distortion

. less than 0.15% at or below
rated min. RMS power output

Intermodulation distortion (70 Hz : 7 kHz = 4:1 SMPTE
method) less than 0.15%

Frequency response (at 1 watt)

. 10 to 50,000 Hz +1 dB -2 dB

RIAA curve deviation (PHONO)

. +0.5 dB -0.5 dB
(30 to 15,000 Hz)

Damping factor approximately 30 at 8 ohms
load

Input sensitivity and impedance (1 kHz, for rated power
output)

PHONO 2.5 mV/47 kilohms
(Max. input capability; 200 mV at 1 kHz, less than
0.5% total harmonic distortion)

AUX, TAPE 150 mV/47 kilohms

MIC 8 mV/10 kilohms

Output level (1 kHz)

TAPE REC (pin jack) 150 mV/47 kilohms
(DIN) 43 mV

Channel separation (1 kHz, at rated power output)

PHONO better than 50 dB

AUX better than 50 dB

Hum and noise (short-circuit, A network)

PHONO 75 dB

AUX 95 dB

Controls

BASS ±10 dB (50 Hz)

TREBLE ±10 dB (10 kHz)

LOUDNESS (-30 dB)

. 7 dB at 50 Hz

. 5 dB at 10 kHz



SANSUI ELECTRIC CO., LTD.

AM Section

◀G-2000SS▶

(SW1)

Tuning range 2.3 to 6.5 MHz
Usable sensitivity 20 μ V
Selectivity (± 10 kHz) 45 dB
Signal to noise ratio 46 dB

(SW2)

Tuning range 6.5 to 18 MHz
Usable sensitivity 30 μ V
Selectivity (± 10 kHz) 45 dB
Signal to noise ratio 46 dB

◀G-2000L, G-3000L▶

(MW)

Tuning range 530 to 1,600 kHz
Usable sensitivity (Bar antenna)
. 50 dB/m (300 μ V/m)
Selectivity (± 10 kHz) 45 dB
Signal to noise ratio 46 dB

(LW)

Tuning range 150 to 350 kHz
Usable sensitivity 60 dB/m (1,000 μ V/m)
(bar antenna)
300 μ V (EXT)
Selectivity 45 dB
Signal to noise ratio 46 dB

FM Section

◀G-2000SS, G-2000L, G-3000L▶

Tuning range 88 to 108 MHz

Usable sensitivity
Mono IHF 11.0 dBf (1.95 μ V)
DIN 1.2 μ V
Stereo IHF 19.0 dBf

50 dB quieting sensitivity

Mono 15 dBf
Stereo 39 dBf

Signal to noise ratio (at 65 dBf)

Mono 71 dB
Stereo 68 dB

Distortion (at 65 dBf)

Mono less than 0.18% at 100 Hz
less than 0.15% at 1,000 Hz
less than 0.25% at 6,000 Hz
Stereo less than 0.3% at 100 Hz
less than 0.25% at 1,000 Hz
less than 0.30% at 6,000 Hz

Alternate channel selectivity (at 400 kHz)

. 50 dB

Capture ratio 1.3 dB

Image response ratio 48 dB (at 98 MHz)

Spurious response ratio 70 dB (at 98 MHz)

Stereo separation 30 dB at 100 Hz

40 dB at 1,000 Hz

28 dB at 10,000 Hz

Frequency response 30 to 15,000 Hz

+0.5 dB -1.0 dB

Antenna input impedance

. 300 ohms balanced

75 ohms unbalanced

Others

◀G-2000SS, G-2000L, G-3000L▶

Power requirements

Power voltage 100, 120, 220, 240V
(50/60 Hz) ◀G-2000SS▶
220, 240V (50 Hz)

◀G-2000L, G-3000L▶

Power consumption 155 watts ◀G-2000SS, G-2000L▶

210 watts ◀G-3000L▶

Dimensions 433 mm (17-1/16") W

153 mm (6-1/16") H

352 mm (13-7/8") D

Weight 7.3 kg (16.1 lbs) net

G-2000SS, 2000L

8 kg (17.6 lbs) net ◀G-3000L▶

8.7 kg (19.2 lbs) packed

◀G-2000SS, G-2000L▶

9.4 kg (20.7 lbs) packed ◀G-3000L▶

* Design and specifications subject to change without notice for improvements.

1. OPERATIONS

Pop-noise preventive circuit

In order to prevent the annoying pop-noise to the loudspeakers at turning the power of the amplifier ON, the pop-noise preventive circuit adopted in the G-3000L is the combination of the conventional driver-voltage delay type used in the power supply (rectifier) circuit and the NF delay type pop-noise preventive circuits. The configuration of NF delay type pop-noise preventive circuit is shown in Fig. 1.

In this circuit, the switching (ON-OFF) of the transistor TR05 is made by the time constant of the capacitor C40 and resistor R88. Thereby the NF resistor, R51 is controlled, and the gain of the main amplifier stage is lowered when TR05 is ON, thus the voltage drift (transient voltage) of the main amplifier at turning the power ON does not appear on the speaker terminals for very short period of time. In other words, at the instant that the power is turned ON, the voltage at the point A rises up to +13V, then the voltage decreases by means of the time constant of C40 and R88 as shown in Fig. 2. At this time, the diode D11 is inversely biased, consequently, the potential voltage of the point B is 0V as Fig. 3. Because of this, TR05 turns to the cut-off, thus the NF resistor, R51 acquires such a state as its resistance value becomes equivalently very large, which decreases the gain of the power amplifier. When the charge of the C40 is completed, the voltage of the point B (see Fig. 3) becomes negative, as a result, the diode D11 is biased. Therefore, TR05 is turned ON, and the circuit of this equipment is normally operated approximately 2 seconds after the power is turned ON to prevent the pop-noise which flows to loudspeakers.

Fig. 1

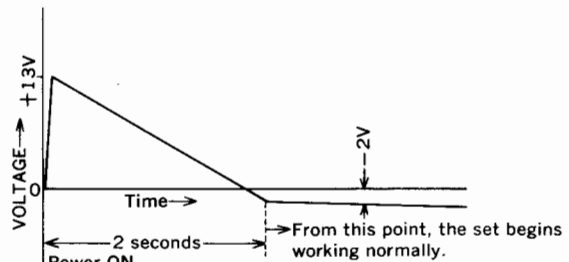
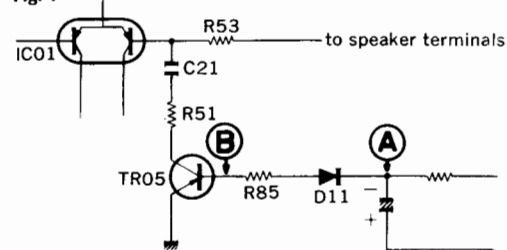

Fig. 2 Voltage variation during a certain period of time at A

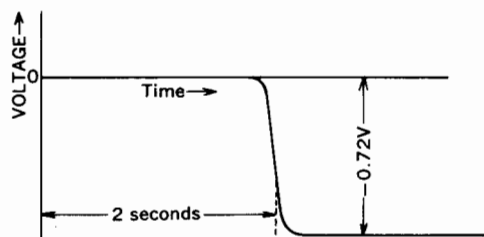

Fig. 3 Voltage variation at B

3. ADJUSTMENTS

1. FM Adjustment

* Refer to the picture of top view and illustrations indicating test points on page 4.

- Note: 1. Selector FM AUTO
 2. FM Muting Switch OFF
 3. Connection . . Connect the output of genescopes to TP through 100pF ceramic capacitor.

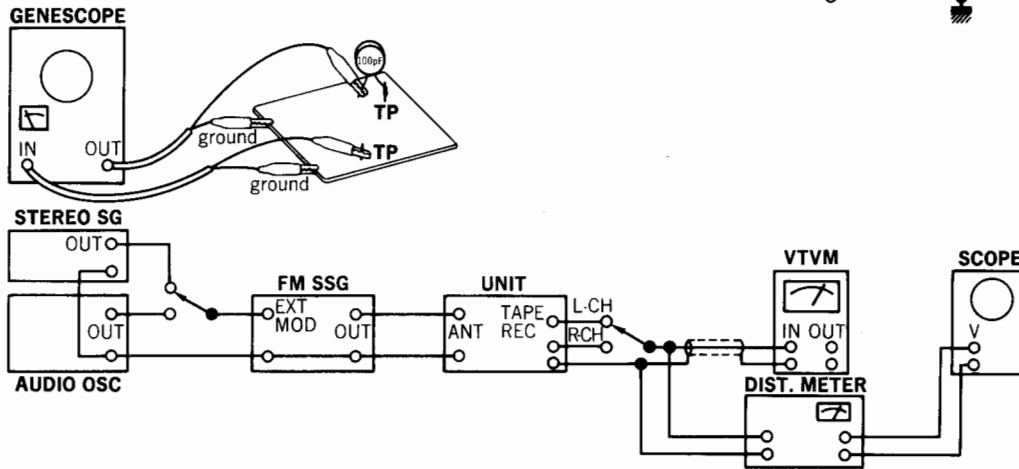
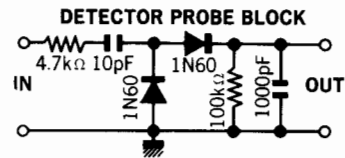

FM IF Adjustment & Dial Calibration <<G-2000SS/G-2000L/G-3000L>>

STEP	SUBJECT	FEED SIGNAL		MEASURE OUTPUT	ADJUST	ADJUST FOR	REMARKS
		FROM	TO				
1.	IF Coil	Output 60 dB Genescopes	TP1 F-2824	Point (A) F-2824 Use Detector Probe	T01 F-2824	Max. IF waveform	
2.	Discriminator Coil	Same as above	Same as above	Point (B) F-2824	T02, T03 F-2824	Steep linearity of S curve Make symmetrical S curve	
3.	Tuning Meter	98 MHz ANT Input 65 dBf (59.8 dB) 1000 Hz (100% MOD) FM SSG	ANT terminal 300Ω	Tuning Meter	T02 F-2824	Center on Meter	Tuning
4.	90 MHz Dial Calibration	90 MHz ANT Input 65 dBf (59.8 dB) 1000 Hz (100% MOD) FM SSG	Same as above	REC terminal L or R-CH VTVM & Scope	L03 F-2824	MAX. output	
	106 MHz Dial Calibration	106 MHz ANT Input 65 dBf (59.8 dB) 1000 Hz (100% MOD) FM SSG	Same as above	Same as above	TC03 F-2824		
5.	90 MHz RF Adj.	90 MHz ANT Input Minimum value with sine wave 400 Hz (100% MOD) FM SSG	Same as above	Same as above	L01, L02 F-2824	Same as above	
	106 MHz RF Adj.	106 MHz ANT Input Minimum value with sine wave 400 Hz (100% MOD) FM SSG	Same as above	Same as above	TC01, TC02 F-2824	Same as above	
6.	Signal Meter Volume	98 MHz ANT Input 65 dBf (59.8 dB) 1000 Hz (100% MOD) FM SSG	Same as above	Signal Meter	VR03 F-2824	4.3 on Meter	

FM STEREO Adjustment

STEP	SUBJECT	FEED SIGNAL		MEASURE OUTPUT	ADJUST	ADJUST FOR	REMARKS
		FROM	TO				
1.	PLL VCO Adj.	98MHz ANT Input 65dBf (59.8dB) FM SSG Pilot 19kHz (9% MOD) SUB 1kHz + Pilot (100% MOD) STEREO SG	ANT terminal 300 Ω	Stereo indicator	VR01 F-2824	Light indicator	Adjust the VR01 within center of lighting level.
	PLL VCO Adj. In case of using Freq. counter.	98MHz ANT Input 65dB (59.8dB) FM SSG	Same as above	TP4 F-2824 Use Freq. counter	VR01 F-2824	76kHz ±150Hz	
2.	Separation	98 MHz ANT Input 65 dBf (59.8 dB) FM SSG Pilot 19 kHz (9% MOD) R Mode 1 kHz + Pilot (100% MOD) STEREO SG	Same as above	REC terminal L-CH VTVM & Scope	VR02 F-2824	Set -34 dB	Confirm separation L-CH → R-CH (-34 dB)

<Top View> <G-3000L> * Test points of G-2000SS & G-2000L are located the same as G-3000L.

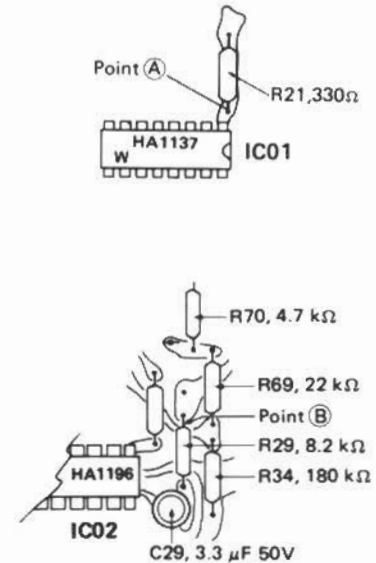
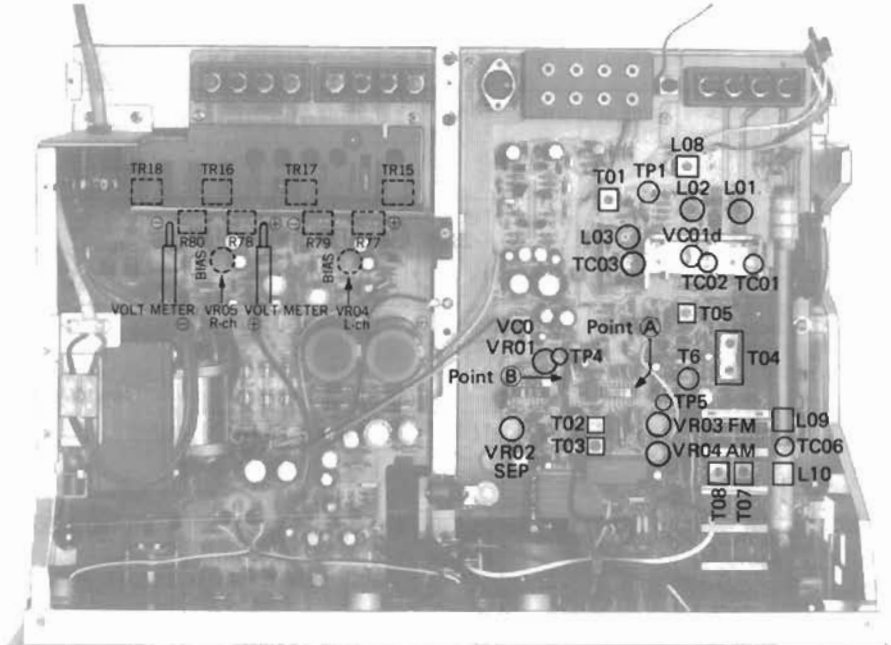

NEW MEASUREMENT FOR FM.

Input signal level under the provision of IHFM-T-200, a new measurement method is indicated by available power ratio "dBf". To obtain approximate available power ratio "dBf", abstract 0.8 from attenuator indication of general FMSG (open load indication type); however, the conventional measurement, IHFM-T-100 is designated together too.

The way of modulation on IHFM-T-200 is shown below.

	modulation frequency	modulation mode	modulation factor
FM MONO	1000Hz		100%
FM STEREO	1000Hz	SUB	Pilot 9% Pilot + SUB 100%

※ The relation between the standard input 65 dBf of IHFM-T-200 and the former indication "dB" is shown in below.

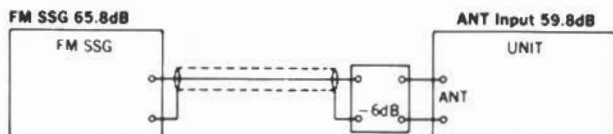

2. AM IF Adjustment & Dial Calibration



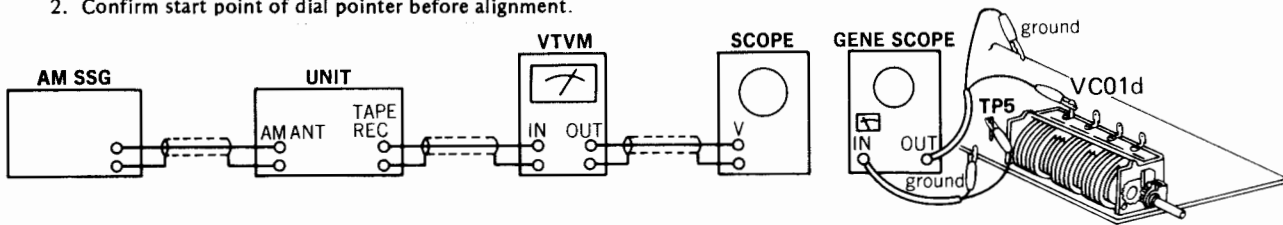

- Note: 1. Selector SW₁ & SW₂ <<G-2000SS>>
MW & LW <<G-2000L, G-3000L>>
2. Confirm start point of dial pointer before alignment.

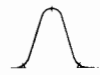
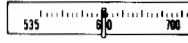

<<G-2000SS>>

STEP (Selector)	SUBJECT	FEED SIGNAL		MEASURE OUTPUT	ADJUST	ADJUST FOR	REMARKS
		FROM	TO				
1	IF Coil	Genescope output level 60 dB	VC01d F-2824	TP5 F-2824	T04, T05, T06 F-2824	MAX. IF waveform	
2 (SW ₁)	2.5 MHz Dial Calibration	2.5 MHz ANT Input 60 dB 400 Hz (MOD 30%) AM SSG	AM ANT Terminal	REC terminal L or R-CH VTVM & Scope	T07 F-2824	MAX. indication on signal meter & VTVM	
	6 MHz Dial Calibration	6 MHz ANT Input 60 dB 400 Hz (MOD 30%) AM SSG	Same as above	Same as above	TC04 F-2824	Same as above	
3 (SW ₂)	7 MHz Dial Calibration	7 MHz ANT Input 60 dB 400 Hz (MOD 30%) AM SSG	Same as above	Same as above	T08 F-2824	Same as above	
	16 MHz Dial Calibration	16 MHz ANT Input 60 dB 400 Hz (MOD 30%) AM SSG	Same as above	Same as above	TC05 F-2824	Same as above	
4 (SW ₁)	2.5 MHz RF Adj.	2.5 MHz ANT Input 50 dB 400 Hz (MOD 30%) AM SSG	Same as above	Same as above	L09 F-2824	Same as above	
	16 MHz RF Adj.	16 MHz ANT Input 50 dB 400 Hz (MOD 30%) AM SSG	Same as above	Same as above	TC06 F-2824	Same as above	
5 (SW ₂)	7 MHz RF Adj.	7 MHz ANT Input 50 dB 400 Hz (MOD 30%) AM SSG	Same as above	Same as above	L10 F-2824	Same as above	
	16 MHz RF Adj.	16 MHz ANT Input 50 dB 400 Hz (MOD 30%) AM SSG	Same as above	Same as above	TC07 F-2824	Same as above	
6	Signal Meter Volume	1000 kHz ANT Input 80 dB/m 400 Hz (MOD 30%) AM SSG	Same as above	Signal Meter	VR04 F-2824	4.5 on meter	

◀G-2000L/3000L▶

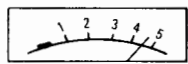
STEP (Selector)	SUBJECT	FEED SIGNAL		MEASURE OUTPUT	ADJUST	ADJUST FOR	REMARKS
		FROM	TO				
1	IF Coil	Genescope output level 60 dB	VC01d F-2824	TP5	T04, T05, T06 F-2824	MAX. IF waveform	
2 (MW)	600 kHz Dial Calibration	600 kHz ANT Input 60 dB 400 Hz (MOD 30%) AM SSG	AM ANT Terminal	REC terminal L or R-CH VTVM & Scope	T07 F-2824	MAX. indication on signal meter	
	1400 kHz Dial Calibration	1400 kHz ANT Input 60 dB 400 Hz (MOD 30%) AM SSG	Same as above	Same as above	TC04 F-2824		
3 (LW)	150 kHz Dial Calibration	150 kHz ANT Input 60 dB 400 Hz (MOD 30%) AM SSG	Same as above	Same as above	T08 F-2824	Same as above	
	350 kHz Dial Calibration	350 kHz ANT Input 60 dB 400 Hz (MOD 30%) AM SSG	Same as above	Same as above	TC05 F-2824		
4 (MW)	600 kHz RF Adj.	600 kHz ANT Input 50 dB 400 Hz (MOD 30%) AM SSG	Same as above	Same as above	L07a Bar Antenna Coil	Same as above	
	1400 kHz RF Adj.	1400 kHz ANT Input 50 dB 400 Hz (MOD 30%) AM SSG	Same as above	Same as above	TC06 F-2824	Same as above	
5 (LW)	150 kHz RF Adj.	150 kHz ANT Input 50 dB 400 Hz (MOD 30%) AM SSG	Same as above	Same as above	L07b Bar Antenna Coil	Same as above	
	350 kHz RF Adj.	No this adjustment is necessary.					
6	Signal Meter Volume	1000 kHz ANT Input 80 dB 400 Hz (MOD 30%) AM SSG	Same as above	Signal Meter	VR04 F-2824	4.5 on meter	

3. Bias Current Adjustment (See the picture of top view on page 4)

◀G-2000S, G-2000L, G-3000L▶

1. Confirm AC power supply voltage, 220 V or 240 V provided.
2. Level Volume Minimum
3. Room Temperature 18°C ~ 28°C
(65°F ~ 83°F)
4. Before this adjustment, turn bias adjustment volumes of VR04 and VR05 fully counterclockwise, then run this unit for more than three minutes.

Note: For this adjustment, put the lead + (plus) side of volt meter to + (plus) side of R77 (& R78), and the lead - (minus) side of R79 (& R80) on both channels.

L-ch R77, R79 (Measure output voltage)
R-ch R78, R80 on both channels)

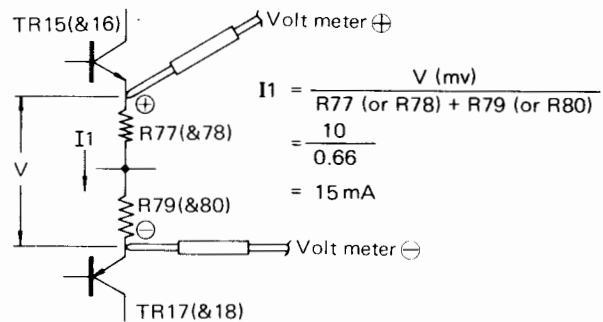

Fig. 1 (Power stage on F-2711)

$$I_1 = \frac{V \text{ (mv)}}{R77 \text{ (or R78)} + R79 \text{ (or R80)}} = \frac{10}{0.66} = 15 \text{ mA}$$

STEP	SUBJECT	EQUIPMENT	MEASURE OUTPUT	ADJUST	ADJUST FOR
1	Bias Current L-CH	DC Volt meter	* See Fig. 1 above	VR04 F-2711	10 mV ±1 mV (15 mA)
2	Bias Current R-CH	DC Volt meter	* See Fig. 1 above	VR05 F-2711	10 mV ±1 mV (15 mA)

4. PARTS LOCATION & PARTS LIST

Since some of capacitors and resistors are omitted from parts lists in this Service Manual, refer to the Common Parts List for capacitors & resistors which was appended previously to each Sansui Manual.

1. F-2711 Pre/Main & Power Supply Circuit Board (Stock No. 7571821, G-2000SS) (Stock No. 7571831, G-2000L) (Stock No. 7571811, G-3000L)

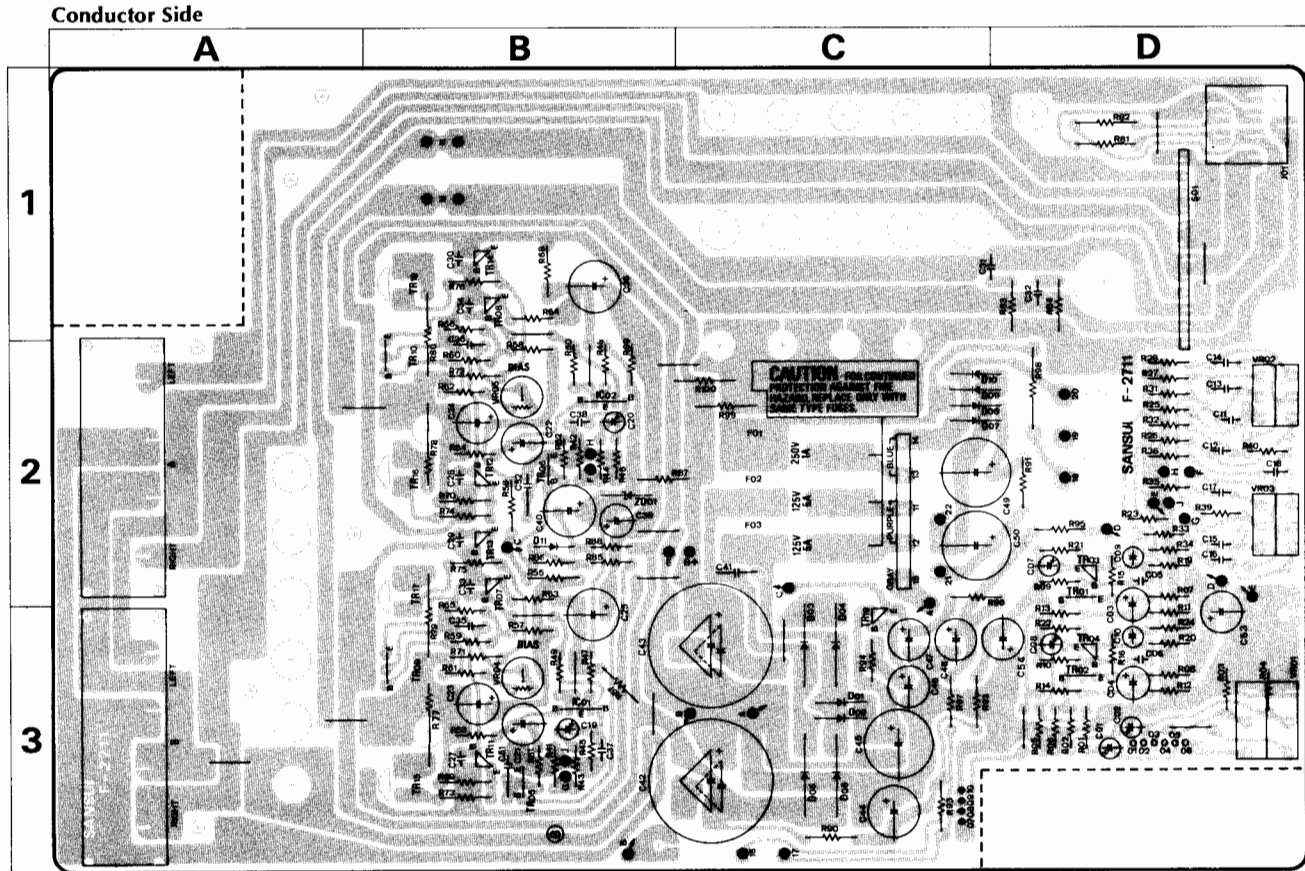

Parts List

Parts No.	Stock No.	Description	Position	Parts No.	Stock No.	Description	Position	Parts No.	Stock No.	Description	Position
TR01,02	0300470,1	2SA726W (F, G)	2D,3D			◀G-2000SS, G-2000L▶				Level Volume	
TR03,04	0306070,1	2SC1313 (F, G)	2D,3D			6,800 μF 35V E.C.		VR02	1015300,1	100 kΩ (A) x 2	2D
TR05,06	0300510,1	2SA733 (P, G)	3B		0549009	◀G-3000L only▶				Bass Volume	
										100 kΩ (A) x 2	2D
TR07,08	0306371,2	2SC1175 (E, F)	2B	R 55,56	0210182	1.8 kΩ 1/4W N.I.R.	2B			Treble Volume	
				R 67,68	0192101	100 Ω 1/4W F.R.	3B,1B	VR04,05	1035050	470 Ω (B)	3B,2B
	0306521,2	2SC1439 (B, V)		R 69~72	0192221	220 Ω 1/4W F.R.	3C,2B			Bias Adjusting Volume	
				R 73~76	0192689	6.8 Ω 1/4W F.R.	2B,1B				
TR09,10	0305951,2	2SC945 (P, Q)	3B,2B	R 77~80	0212338	0.33 Ω 2W N.I.R.	3B,2B	S 701	1190530	Power Switch ◀G-2000SS▶	
TR11,12	0305930,1	2SC1211 (C, D)	3B,2B	R 81,82	0211221	220 Ω 1W N.I.R.	1D		1190600	Power Switch ◀G-2000L▶	
				R 83,84	0210479	4.7 Ω 1/4W N.I.R.	1D		1101880	Rotary Switch, Power/Speaker Selector	
	0308521,2	2SD438 (E, F)		R 87	0210272	2.7 kΩ 1/4W N.I.R.	2B			◀G-3000L only▶	
TR13,14	0300310,1	2SA697 (C, D)	Transistor 2B		0210122	1.2 kΩ 1/4W N.I.R.					
								F 01	0432220	1A 250V AC Fuse ◀G-2000SS▶	2C
	0303361,2	2SB560 (E, F)		R 90	0210221	220 Ω 1/4W N.I.R.	3C		0435090	800 mA 250V AC Fuse	
										◀G-2000L, G-3000L▶	
TR15,16	0308392,3	2SD313 (E, F)	3B,2B		0210271	270 Ω 1/4W F.R. ◀G-3000L only▶		F 02,03	0432280	4A 125V AC Fuse ◀G-2000SS▶	2C
				R 91	0192220	22 Ω 1/4W F.R.	2D		0435150	3,15A 125V AC Fuse	
	0306541,2	2SC1986 (Q, Y)		R 92	0210471	470 Ω 1/4W N.I.R.	3C			◀G-2000L only▶	
									0435160	4A 250V AC Fuse ◀G-3000L only▶	
TR17,18	0303232,3	2SB507 (E, F)	2B,1B		0210681	680 Ω 1/4W N.I.R. ◀G-3000L only▶		F 04,05	0432280	4A 125V AC Fuse ◀G-2000SS▶	
				R 93	0210221	220 Ω 1/4W N.I.R.	3C		0435150	3,15A 125V AC Fuse	
	0300911,2	2SA771 (Q, Y)								◀G-2000L only▶	
TR19	0306521,2	2SD438 (E, F)	3C	R 95	0210331	330 Ω 1/4W N.I.R. ◀G-3000L only▶			0435160	4A 250V AC Fuse ◀G-3000L only▶	
				R 96	0210471	470 Ω 1/4W N.I.R.	2D	J 01	2430380	Headphone Jack Socket	1D
IC 01,02	0360290,1	2SA798 (E, F)	3B,2B		0210681	680 Ω 1/4W N.I.R. ◀G-3000L only▶				◀G-2000SS, G-2000L only▶	
				R 97	0210820	82 Ω 1/4W N.I.R.	2C		2430360	Headphone Jack Socket	
D 01,02	0310340	10D1	3C						2210340	4P Speaker Output Terminal	
D 03~06	0310340	10D1	3C	R 97	0210151	150 Ω 1/4W N.I.R. ◀G-3000L only▶	3C		2310220	Fuse Holder ◀G-2000SS▶	
					0210221	220 Ω 1/4W N.I.R.			2310230	Fuse Holder	
	0311530	30D2 ◀G-3000L only▶	Diode 2C							◀G-2000L, G-3000L only▶	
D 07~10	0310340	10D1	3C	R 98	0210271	270 Ω 1/4W N.I.R. ◀G-3000L only▶	3C				
D 11	0311160	1S2473D	2B	R 99	0212829	8.2 Ω 2W N.I.R.	2D				
				R 99,100	0211222	2.2 kΩ 1W N.I.R.	2C				
ZD01	0315970	EQA01-13R Zener Diode	2D	L 01,02	4210290	RF Coil 1.5 μH					
						◀G-2000L, G-3000L only▶					
C 41	0655103	10,000 pF 500V C.C.	2C	VR01	1011130,1	250 kΩ (B) x 2	3D				
C 42,43	0549008	4,700 μF 35V E.C.	3C								

2. F-2824 TUNER & PRE-AMP CIRCUIT BOARD

(Stock No. 7521651, G-2000SS) (Stock No. 7521591, G-2000L) (Stock No. 7521621, G-3000L)

Conductor Side

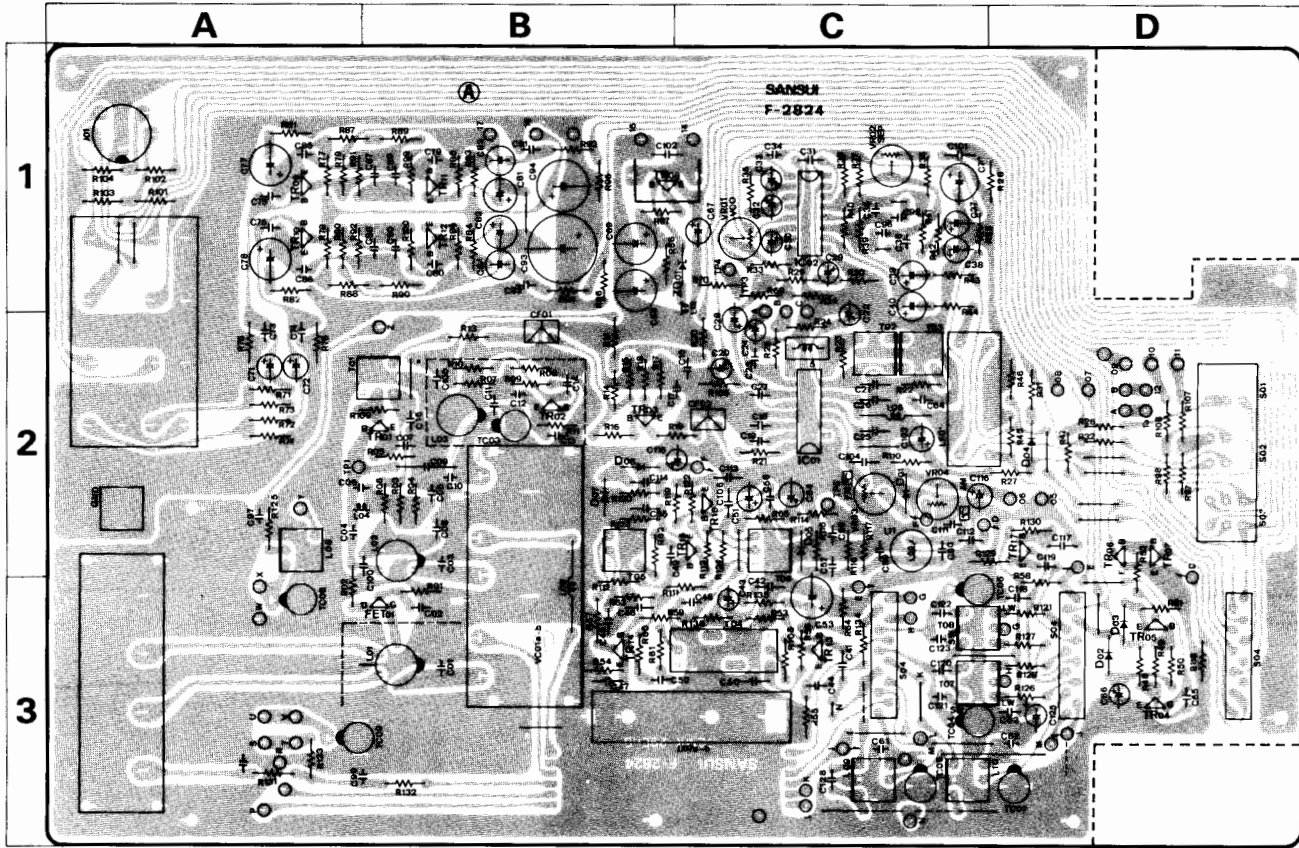

Parts List

Parts No.	Stock No.	Description	Position	Parts No.	Stock No.	Description	Position	Parts No.	Stock No.	Description	Position
TR01, 02	0305801, 2	2SC1047 (B, C)	2B	C 11, 12	0669270	10 pF 50V C.C. <<G-2000SS>>	2B	T 01	4235930	IF Coil (FM)	2B
TR03	0306341, 2	2SC1474 (L, K)	2B		0669370	10 pF 50V C.C.		T 02	4235990, 1	IF Coil (FM)	2C
TR04	0305951, 2	2SC945 (Q, P)	3D			<<G-2000L, G-3000L>>		T 03	4236000, 1	IF Coil (FM)	2C
TR05	0300470	2SA725W (F)	3D	C 13	0669356	10 pF 50V C.C. <<G-2000SS>>	2B	T 04	0910370	Ceramic Filter	3C
TR06, 07	0306581, 2	2SC1634	2B		0669370	10 pF 50V C.C.		T 05	4230610	IF Coil (AM)	2B
TR08	0308450, 1	2SD356 (C, D)	1B	C 32	0573159	1.5 μF 35VW T.C.	1C	T 06	4230500	IF Coil (AM)	2C
TR09, 10	0300900, 1	2SA906 (G, H)	1A	C 33	0573339	3.3 μF 35VW T.C.	1C	T 07	4220620	12 μH O.S.C. (AM) <<G-2000SS>>	3C
TR11, 12	0306070, 1	2SC1313 (F, G)	1B	C 34	0629005	360 pF 50V P.C.	1C	T 08	4220630	150 μH O.S.C. <<G-2000SS>>	3C
TR13	0306341, 2	2SC1674 (L, K)	3C	C 89, 90	0620161	160 pF 50V P.C.	1B		4220610	O.S.C. Coil <<G-2000SS>>	3C
		<<G-2000SS>>		C 95, 96	0620751	750 pF 50V P.C.	1C		4220600	740 μH O.S.C. Coil (AM) <<G-2000L, G-3000L>>	
	0306241, 2	2SC1675 (L, K)	3B	C 120	0620152	1500 pF 50V P.C. <<G-2000SS>>	3C	CF01, 02	0910380	Ceramic Filter (FM)	2B, 2C
		<<G-2000L, G-3000L>>			0620361	360 pF 50V P.C.		LF01	0910220	Low Pass Filter	2C
TR14	0306241, 2	2SC1675 (L, K)	2C			<<G-2000L, G-3000L>>		VR01	1034250	4.7 kΩ (B) VCO Free-Run Adjusting VR	1C
TR15	0306241, 2	2SC1675 (L, K)	2C	C 122	0620332	3300 pF 50V P.C. <<G-2000SS>>	3C	VR02	1035210	220 kΩ Stereo Separation Adjusting VR	1C
TR16	0306241, 2	2SC1675 (L, K)	2D		0620121	120 pF 50V P.C.		VR03	1035150	22 kΩ (B) FM Signal Meter Adjusting VR	2C
TR17	0306341, 2	2SC1675 (L, K)	2D			<<G-2000L, G-3000L>>		VR04	1035110	4.7 kΩ (B) AM Signal Meter Adjusting VR	2C
	0306241, 2	2SC1675 (L, K)		C 128	0620562	5600 pF 50V <<G-2000L, G-3000L>>	3C	S 01	1131060, 1	Push-Switch, FM Muting	2D
		<<G-2000SS>>				<<G-2000L, G-3000L>>		S 04	1103580	Rotary Switch, Selector	3C, D
		<<G-2000L, G-3000L>>		L 04	4900140	1 μH Inductor	2A	S 05	1110380	Slide Switch, (Bar-Ext) <<G-2000L, G-3000L>>	
IC 01	0360350	HA1137W } IC	2C	L 05	4290300	18 μH Inductor	2C	VC01	1220220	AM/FM Variable Capacitor	2, 3B
IC 02	0360320	HA1196	1C	L 06	4290011	Peakng Coil 3.5 μH	2C	TC03	1230090	Trimmer Capacitor	2B
FT01	0370172	2SK49 (H) FET	3B	L 07	4200740	Antenna Coil (AM) <<G-2000L, G-3000L>>	3C	TC04 ~06	1230060	Trimmer Capacitor <<G-2000SS, G-2000L>>	3C
D 01 ~03	0311160	1S2473D Diode	2C, 3D	L 08	4200730	Antenna Coil <<G-2000L, G-3000L>>	1A	TC07	1230060	Trimmer Capacitor <<G-2000L>>	3D
ZD01	0315970	EQA01-13R Zener Diode		L 09	4200620	Antenna Coil <<G-2000SS>>	3C	TC08	1230060	Trimmer Capacitor <<G-2000L only>>	3A
C 01, 03	0669347	12 pF 50V C.C.	3B, 2B	L 10	4200630	Antenna Coil <<G-2000SS>>	3C	J 01	2090030	5P DIN Socket	1A
C 04	0669210	10 pF 50V C.C.	2A	L 11	4230620	IF Coil <<G-2000L, G-3000L>>	2C		2210330	4P Antenna Terminal	
C 06	0669505	5 pF 50V C.C. <<G-2000SS>>	2A	L 12	4900220	100 mH Inductor	2C		2230180	Ground Terminal	
	0669503	3 pF 50V C.C. <<G-2000L, G-3000L>>	2A	L 13	4900110	100 μH Inductor	1C		2200410, 1	8P Input Terminal	
C 09	0679012	1.5 pF 500V Gimmick Capacitor	2B		4290011	3.5 x 10 ⁶ H Choke Coil <<G-2000L only>>					
C 10	0669372	12 pF 50V C.C. Gimmick Capacitor <<G-2000SS>>	2B								
	0669355	20 pF 50V C.C. <<G-2000L, G-3000L>>									

3. F-2825 Circuit Board for Signal Meter
(Stock No. 7521661, G-2000SS) (Stock No. 7521601, G-2000L)
(Stock No. 7521631, G-3000L)

Conductor Side

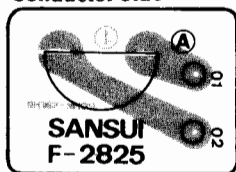

Parts List

Parts No.	Stock No.	Description
M 01	4301110, 1	Signal Meter

4. F-2826 Circuit Board for Tuning Meter
(Stock No. 7521671, G-2000SS) (Stock No. 7521611, G-2000L)
(Stock No. 7521641, G-3000L)

Conductor Side

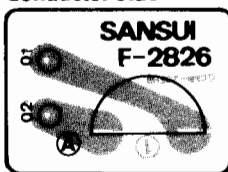

Parts List

Parts No.	Stock No.	Description
M 02	4301120, 1	Tuning Meter

5. F-2827 Circuit Board for Stereo Indicator
(Stock No. 7540831, G-2000SS) (Stock No. 7540821, G-2000L)
(Stock No. 7540841, G-3000L)

Conductor Side

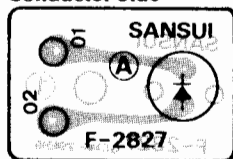

Parts List

Parts No.	Stock No.	Description
LD01	0319060	Light Emitted Diode

6. F-2712 Loudness Circuit Board
(Stock No. 7562051, G-2000SS) (Stock No. 7562041, G-2000L)
(Stock No. 7562061, G-3000L)

Conductor Side

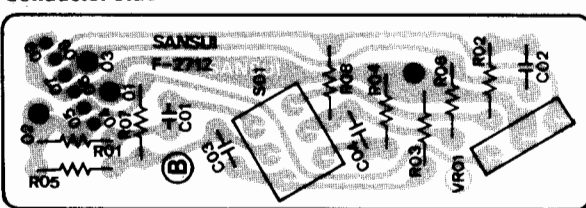

Parts List

Parts No.	Stock No.	Description
VR01	1005350, 1	250 kΩ (B) x 2 Balance Volume
S 01	1131490, 1	Push Switch, loudness

7. F-2713 Microphone Amp Circuit Board
(Stock No. 7610211, G-2000SS) (Stock No. 7610221, G-2000L)
(Stock No. 7610201, G-3000L)

Conductor Side

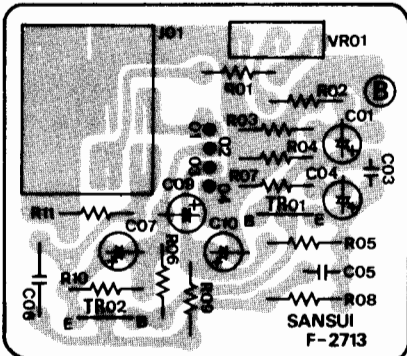

Parts List

Parts No.	Stock No.	Description
TR01	0300470, 1	2SA726W (F, G) Transistor
TR02	0306070, 1	2SC1313 (F, G) Transistor
VR01	1005340, 1	20 kΩ (A) Mixing Volume
J 01	2430370	Mic Jack Socket

8. F-2716 Voltage Selector Circuit Board
(Stock No. 7502691, G-2000SS only)

Conductor Side

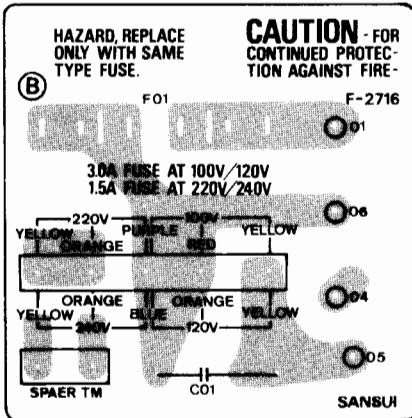

Parts List

Parts No.	Stock No.	Description
C 01	0659802	0.0047 μF 150V C.C.
F 01	0432230	1.5A 250V Fuse Holder
	2310220	

5. OTHER PARTS

<Front View>
<<G-3000L>>

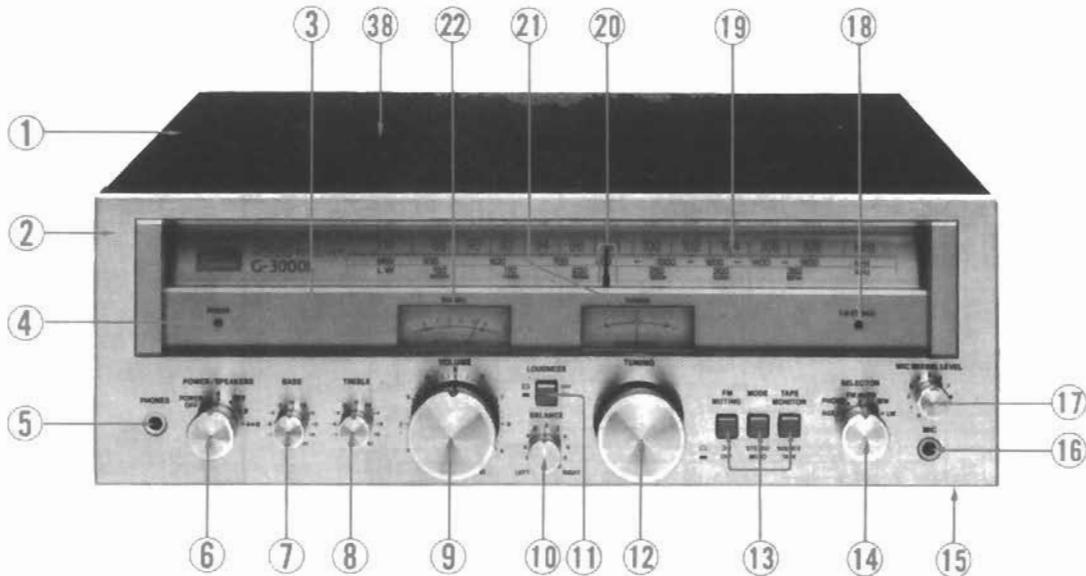

Parts List <<G-2000SS, G-2000L, G-3000L>>

Parts No.	Stock No.	Description	Parts No.	Stock No.	Description	Parts No.	Stock No.	Description
1	5727061	Wood Bonnet	14	5319140	Selector Switch Knob	34	7036540	Tuning Unit
	5236690	W.B Type Bushing		1103580	3-stage Rotary Switch			Washer
2	7007800	Front Panel Ass'y <<G-2000SS>>	15	5058792	Bottom Plate			Flywheel
	7007790	Front Panel Ass'y <<G-2000L>>		5517250	Leg			Tuning Shaft
	7007780	Front Panel Ass'y <<G-3000L>>	16	2430370	Microphone Jack Socket	35	7136100	Tension Unit
3	5305691	Inside Panel	17	5319130	Microphone Mixing Volume Knob	36	0400560	Pilot Lamp Ass'y
4	5426410	Power Illuminator Bar		1005340, 1	20 kΩ (A), Microphone	37	4002660	Power Transformer <<G-2000SS>>
5	2430380	Headphone Jack Socket			Mixing Volume		4002664	Power Transformer <<G-2000L>>
		<<G-2000SS, G-2000L>>	18	0319060	L.E.D. FM Stereo Indicator		4002654	Power Transformer <<G-3000L>>
		<<G-3000L>>		5289180	L.E.D. Holder	TR 15, 16	0308392, 3	2SD313 (E, F)
	2430370	Headphone Jack Socket		5136030	Plastic Rivet			<<G-2000SS, G-2000L>>
		<<G-3000L>>	19	5408260	Dial Scale <<G-2000SS>>		0306541, 2	2SC1986 (Q, Y)
6	5319140	Knob, power (8 speaker) switch		5408340	Dial Scale <<G-2000L>>			<<G-3000L>>
	1190530	Power Switch <<G-2000SS>>		5408250	Dial Scale <<G-3000L>>	TR 17, 18	0303232, 3	2SB507 (E, F)
	1190600	Power Switch <<G-2000L>>	20	7116031	Dial Pointer Ass'y			<<G-2000SS, G-2000L>>
	1101880	Power & Speaker Rotary Switch	21	4301120, 1	Tuning Meter		0300911, 2	2SA771 (Q, Y)
		<<G-3000L>>	22	4301110, 1	Signal Meter			<<G-3000L>>
7	5236470	M9 x 7, Spacer Nut	23	2450060	AC outlet <<G-2000SS only>>		5288721	Plate for the transistor
	5319130	BASS Volume Knob	24	3910600	AC Cord Clip <<G-2000SS>>	C 701	0605337	0.033 μF 250V M.C. <<G-2000SS>>
	1015300, 1	100 kΩ x 2 BASS Volume		3910490	AC Cord Clip <<G-2000L, G-3000L>>	C 701, 702	0598337	0.033 μF 250V M.P.
8	5319130	TREBLE Volume Knob	25	3800010, 4	AC Cord <<G-2000SS>>			<<G-2000L, G-3000L>>
	1015300, 1	100 kΩ x 2 TREBLE Volume		3800120, 1	AC Cord <<G-2000L, G-3000L>>	C 703	0659802	0.0047 μF 150V C.C.
9	5318980	Level Volume Knob	26	2210340	4P Speaker Terminal			<<G-2000L, G-3000L>>
	1011130, 1	250 kΩ (B) x 2 Level Volume	27	2090030	5P DIN Socket		1220220	AM-FM Variable Capacitor
10	5319130	BALANCE Volume Knob	28	2200410, 1	8P Input Terminal			
	1005350, 1	250 kΩ x 2 (B), BALANCE Volume	29	2230180	Ground Terminal			
11	5326690	Loudness Switch Knob	30	2210330	4P Antenna Terminal			
	1131490, 1	Loudness Switch	31	6146670	D-44 Type Pulley			
12	5318970	Tuning Knob	32	4200750	Bar Antenna <<G-2000L, G-3000L>>			
13	1131060, 1	3-gang Push Switch	33	5289170	Bar Antenna Holder			
	5326690	Knob, tape monitor, mode FM muting			<<G-2000L, G-3000L>>			

• Abbreviations

C.R. : Carbon Resistor	E.C. : Electrolytic Capacitor
S.R. : Solid Resistor	BP.E.C. : Bi-Polar Electrolytic Capacitor
Ce.R. : Cement Resistor	C.C. : Ceramic Capacitor
M.R. : Metal Film Resistor	Mi.C. : Mica Capacitor
F.R. : Fusing Resistor	O.C. : Oil Capacitor
N.I.R. : Non-Inflammable Resistor	P.C. : Polystyrene Capacitor
M.C. : Mylar Capacitor	E.C. : Tantalum Capacitor

<Top View>
<G-3000L>

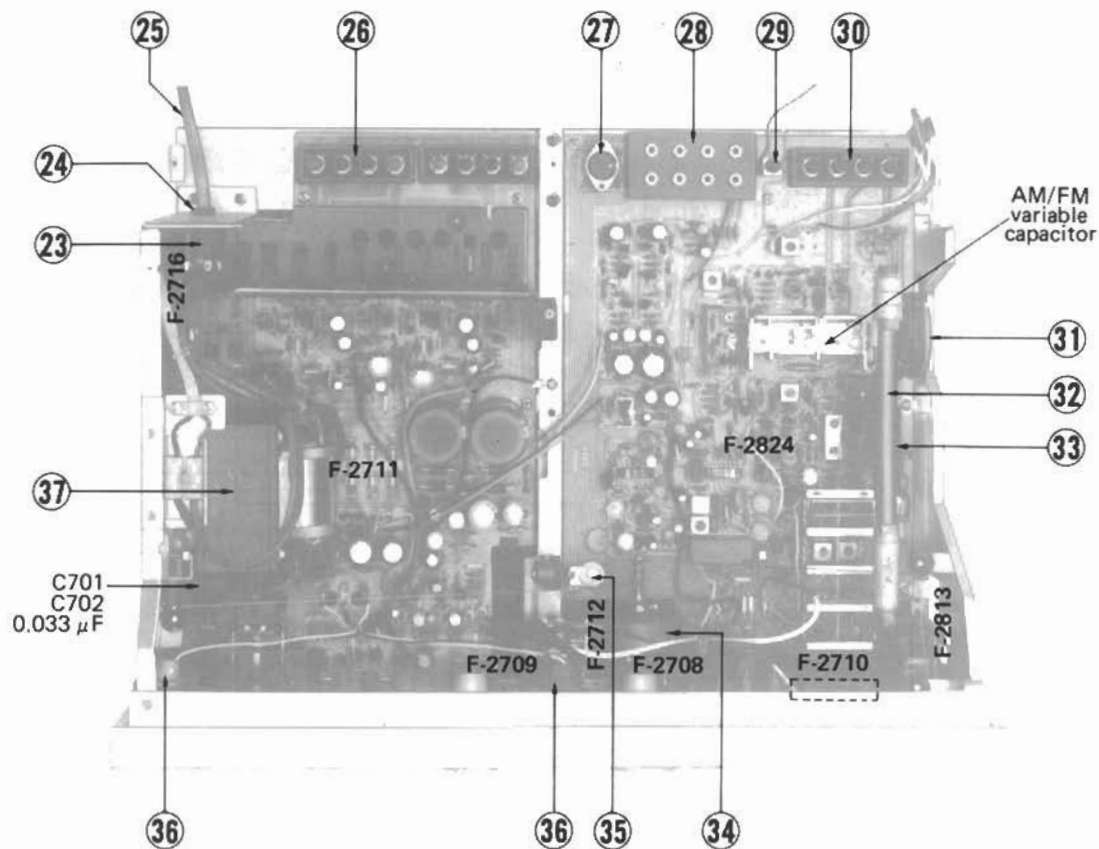

6. PARTS REPLACEMENT

1. Square Knobs of Loudness, FM Muting, Mode & Tape Monitor

1. Take off a wood bonnet, front & inside panels.
2. Then, pull out knobs to which are not glued as Fig. 1.

2. Tuning & Signal Meter

1. Complete 1. & 2. above.
2. Take off the meter as Fig. 2, then put it back into same place until snapped.

Fig. 1

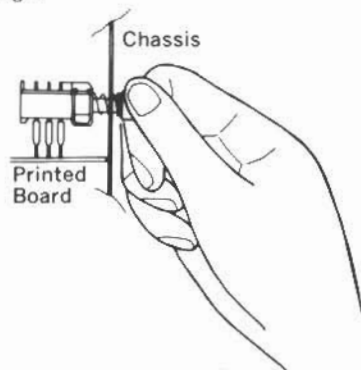
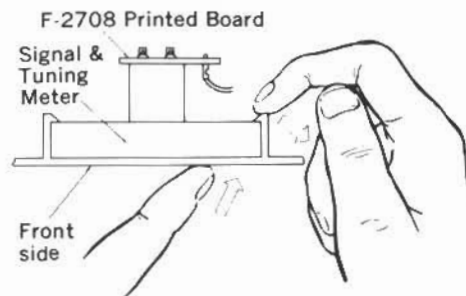

Fig. 2



3. Level Volume

1. Take off the two panels and one nut for level volume.
2. Then, unsolder six points installing the level volume on pattern side of F-2711 printed board.

Fig. 3 Level Volume
(Bottom side) Soldering points

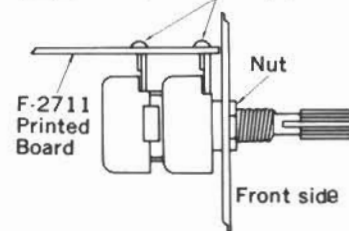

A B C D

7. SCHEMATIC DIAGRAM «G-2000SS»

- SWITCHES & CONTROLS**
- POWER SW 1. on
 - LOUDNESS SW 1. on
 - F-2712 2. on
 - F-2711 1. on
 - F-2710 2. on
 - FM MUTING SW 1. on
 - MODE-F-2704 2. on
 - MODE-F-2704 1. on
 - TAPE MONITOR SW 1. source
 - F-2834 2. tape
 - F-2834 1. auto
 - SELECTION SW 1. SW
 - F-2834 2. SW
- SYMBOL**
- △ Ceramic
 - ▲ Mylar
 - Aluminum Electrolytic
 - ⊕ P/B - Polar Electrolytic
 - ⊖ P/B - Polar Electrolytic
 - ⊕ Fusing Resistor
 - ⊖ Non-fusible Resistor

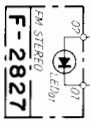
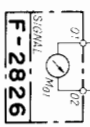
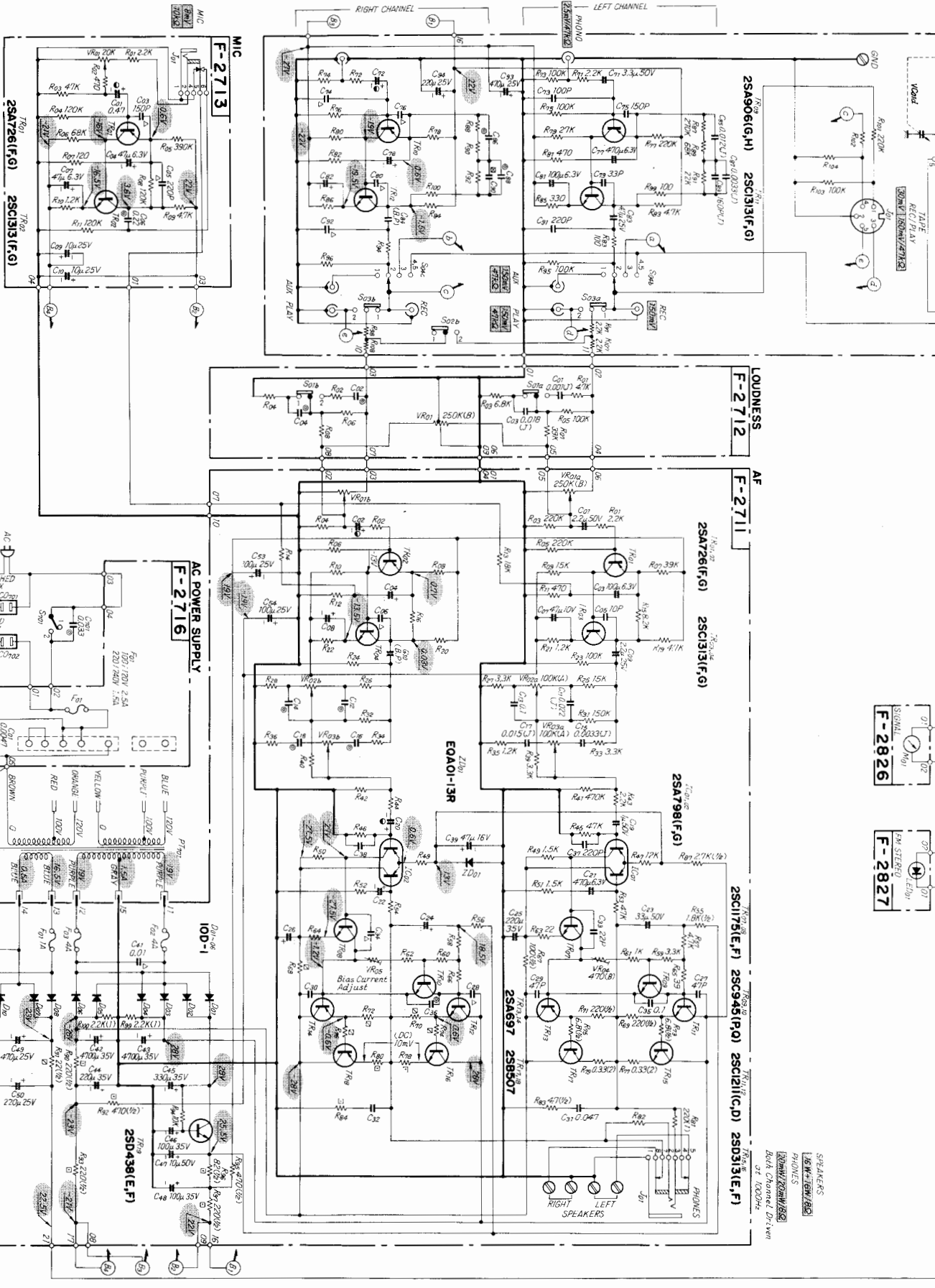

SPEAKERS
1.8W x 16Ω (R)
PHONES
16Ω x 16Ω (R)
BACK Channel Driven
CUT OFF (00000)

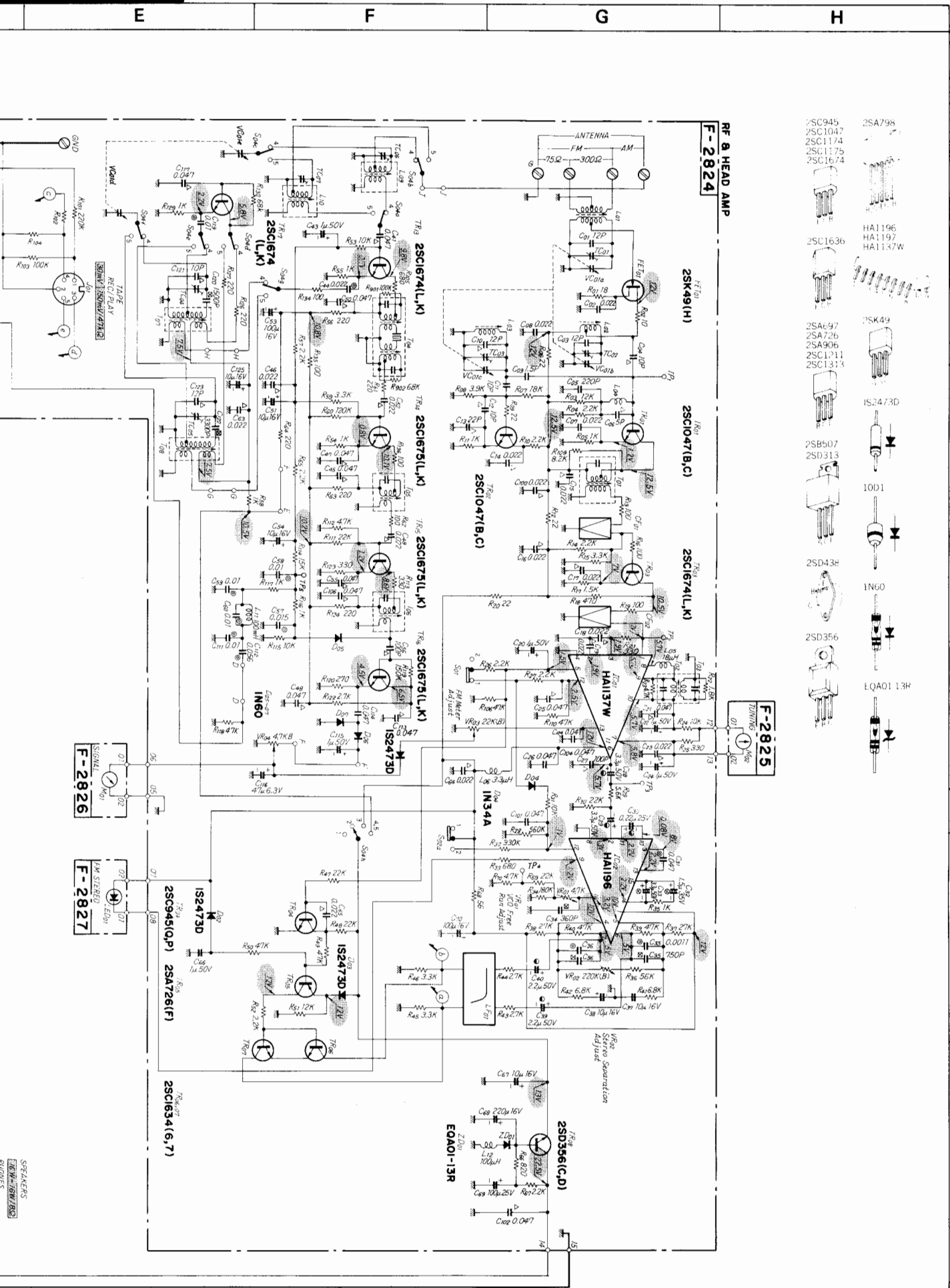

1
2
3
4
5

- 2SC945
- 2SC1047
- 2SC1174
- 2SC1175
- 2SC1674
- 2SC1636
- 2SC1697
- 2SA726
- 2SA906
- 2SC1211
- 2SC1313
- 2SA697
- 2SA726
- 2SA906
- 2SC1211
- 2SC1313
- 2SB507
- 2SD313
- 2SD43E
- 2SD356
- 2SA798
- HA1196
- HA1197
- HA1147W
- 2SK49
- IS2473D
- 1001
- IN60
- EAOA1-13R

SPEAKERS
EAOA1-13R

◀G-2000▶

- SWITCHES & CONTROLS**
- POWER Sw 1, off
 - LOUDNESS Sw 1, off
 - FM MUTING Sw 1, on
 - MODE F-289A 1, stereo
 - TAPE F-289A 2, mono
 - SELECTOR F-289A 1, auto
 - Sw 2c 2, phono
 - Sw 2c 3, FM
 - Sw 2c 4, MW
 - Sw 2c 5, LW
 - Sw 2c 6, EXT
- SYMBOLS**
- ⊕ Resistor
 - ⊖ Capacitor
 - ⊕ Inductor
 - ⊕ Diode
 - ⊕ Transistor
 - ⊕ Vacuum Tube
 - ⊕ Transformer
 - ⊕ Relay
 - ⊕ Switch
 - ⊕ Potentiometer
 - ⊕ Variable Capacitor
 - ⊕ Variable Inductor
 - ⊕ Variable Resistor
 - ⊕ Variable Capacitor
 - ⊕ Variable Inductor
 - ⊕ Variable Resistor
- RESISTORS**
- Are in ohms, % unless .5% tolerance unless otherwise noted. K=K, M=M.
- CAPACITORS**
- Are in pF unless otherwise noted. p=pF.
- TOLERANCE**
- J: ±.5%, G: ±2%, F: ±1%
- Each DC voltage shows the nominal value in volts of no input signal.

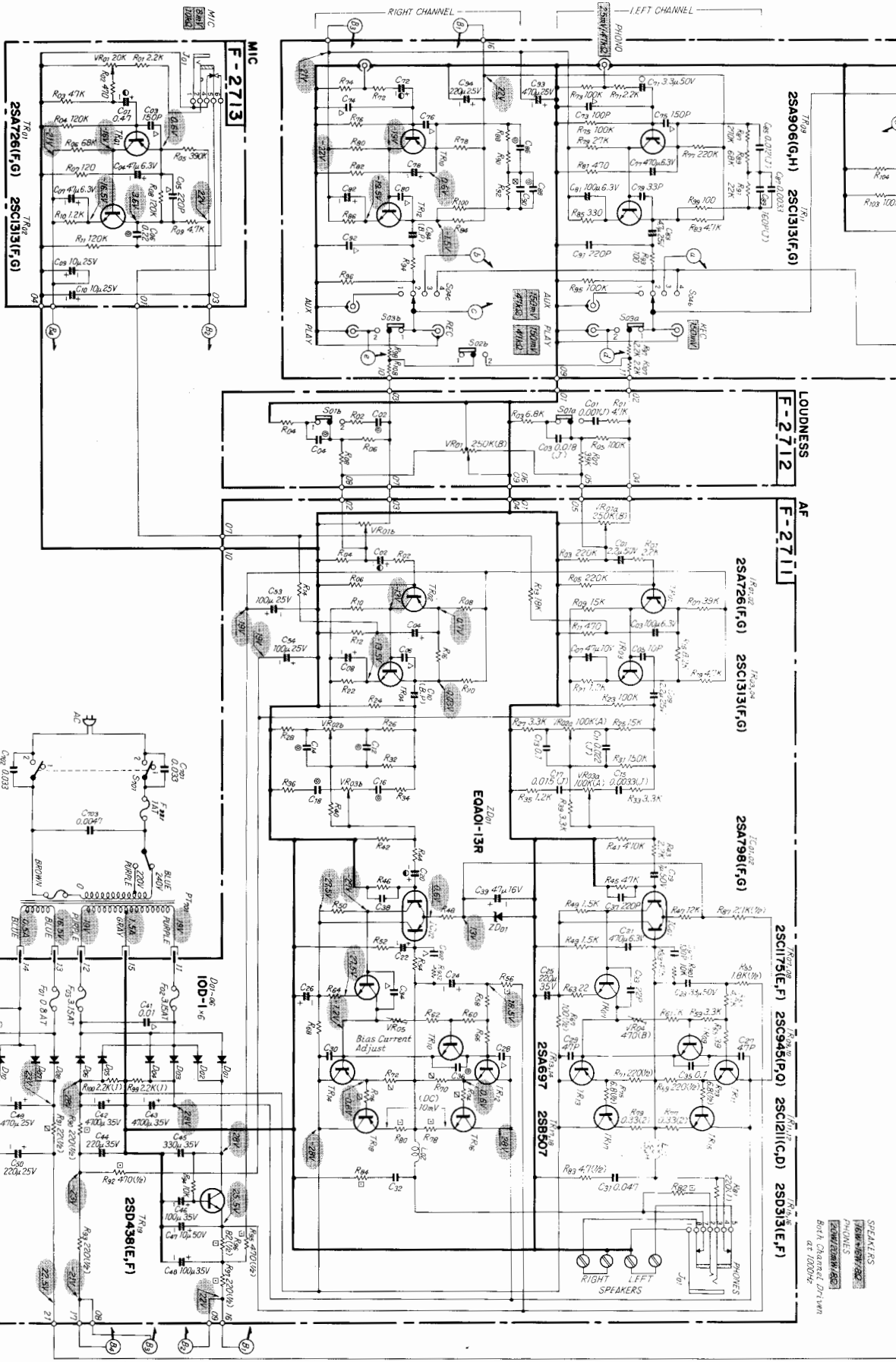

SPEAKERS
PHONES
Both Channels Driven at 1000Hz

←G-3000L→

A B C D

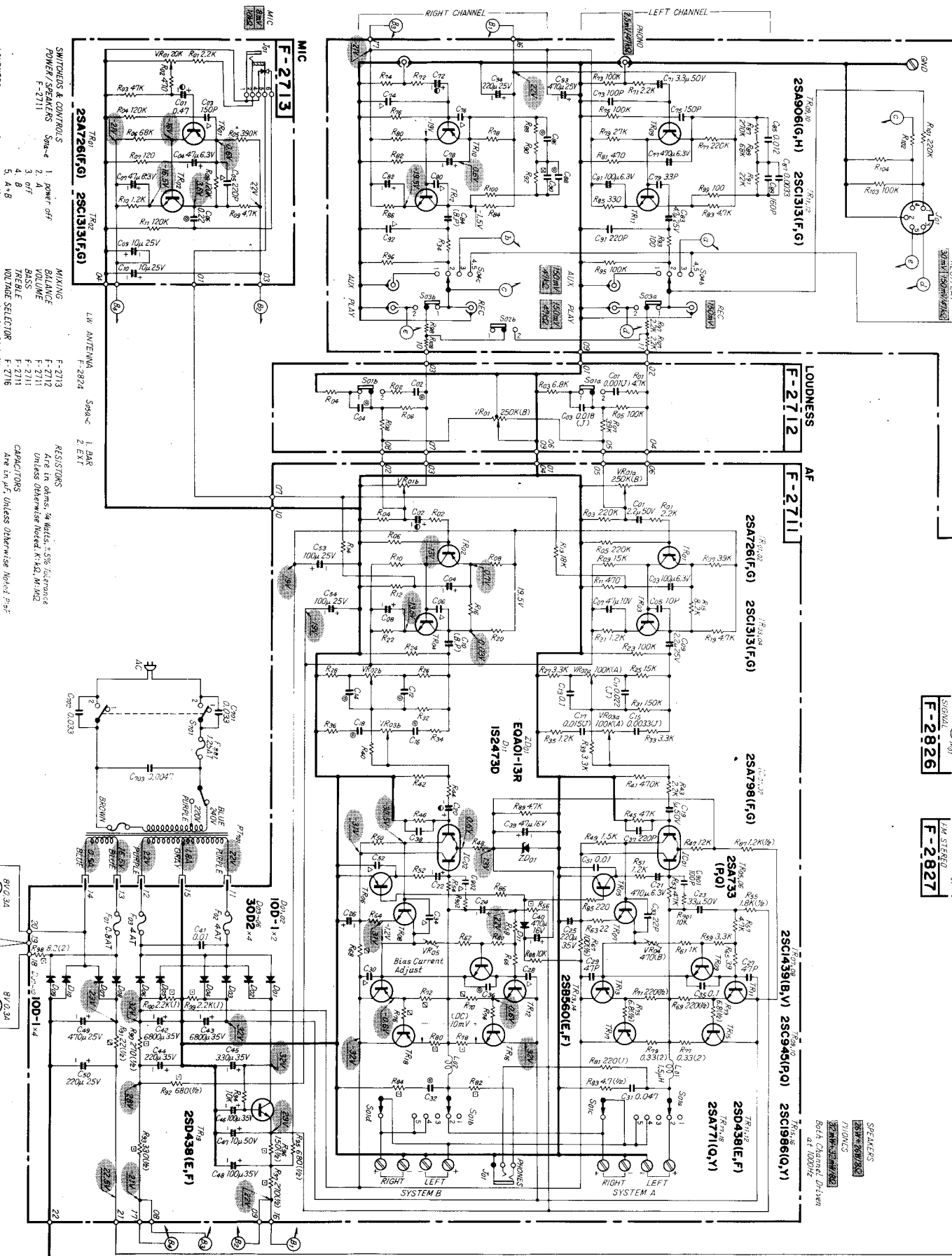

- SWITCHES & CONTROLS**
- POWER/SPEAKERS F-2711
 - LOUDNESS F-2712
 - FM MUTING F-2824
 - MODE F-2824
 - TAPE MONITOR F-2824
 - SELECTOR F-2824
- SYMBOLS**
- △ Ceramic
 - ⊗ Mylar
 - ⊗ Styrol
 - ⊗ Aluminum Electrolytic
 - ⊗ Polystyrene Electrolytic
 - ⊗ Fusing Resistor
 - ⊗ Non-Inflammable Resistor

- MIXING**
- 1. power off
 - 2. A
 - 3. off
 - 4. B
 - 5. A+B
- BALANCE**
- 1. stereo
 - 2. mono
- VOLUME**
- 1. source
 - 2. tape
 - 3. FM
 - 4. MW
 - 5. LW
- TREBLE**
- 1. off
 - 2. on
- BASS**
- 1. off
 - 2. on
- TONE SELECTOR**
- 1. BAR
 - 2. EXT

- RESISTORS**
- F-2712
 - F-2711
 - F-2711
 - F-2711
 - F-2716
- CAPACITORS**
- F-2716
- TOLERANCE**
- J: ±5%
 - G: ±2%
 - F: ±1%

- Notes:**
- Each DC Voltage shows the nominal value in volts ± no input signal.
 - 2N4726 (F)
 - 2N4733 (F)
 - 2N4730 (F)



SPEAKERS
16Ω STEREO
PHONES
Both Channels Driven
at 1000Hz

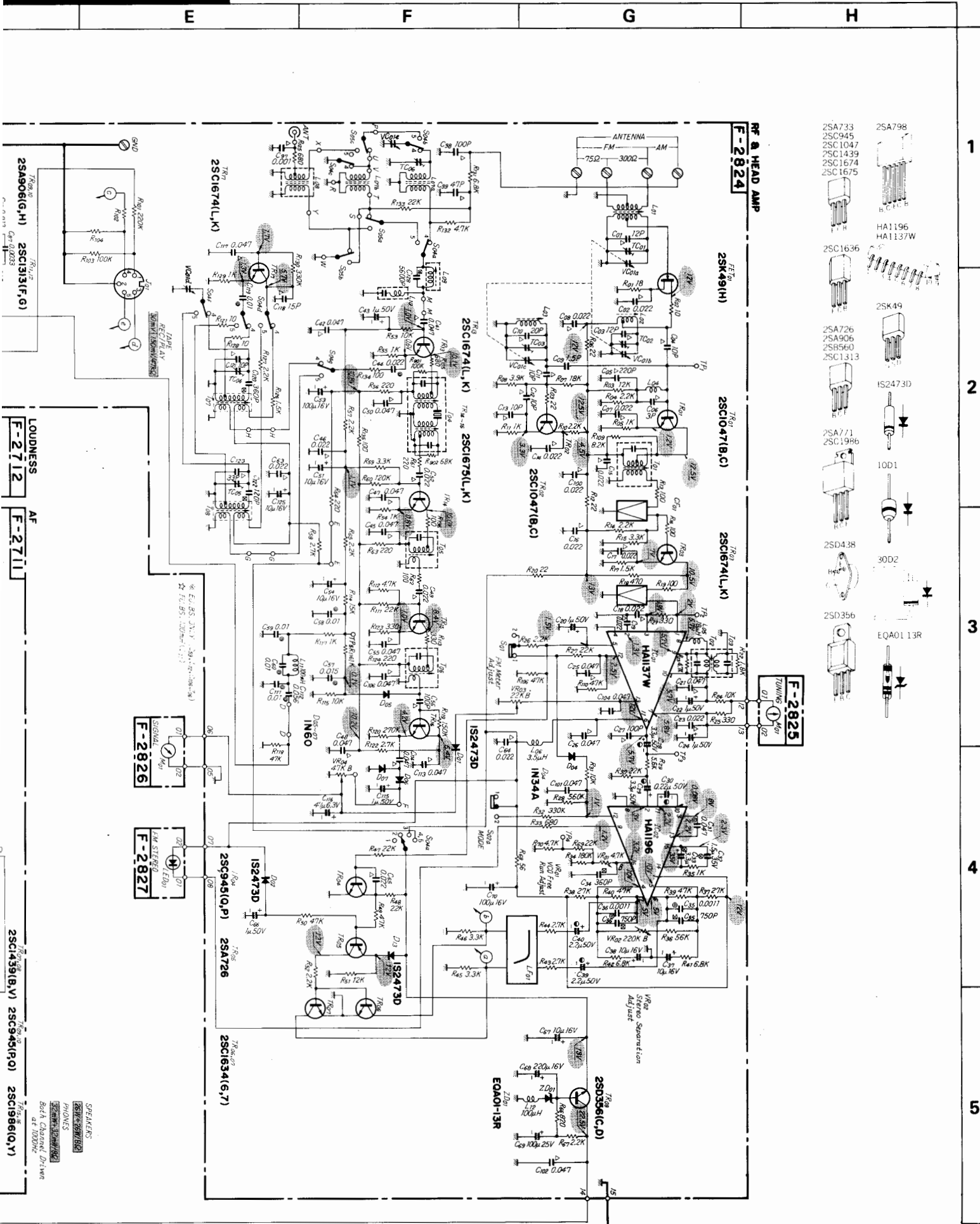

- 2SA733
- 2SC945
- 2SC1047
- 2SC1439
- 2SC1674
- 2SC1675
- 2SA798
- HA1196
- HA1137W
- 2SC1636
- 2SK49
- 2SA726
- 2SA906
- 2SB560
- 2SC1313
- 2SA771
- 2SC1986
- 10D1
- 2SD438
- 30D2
- 2SD356
- EQA01-13R

1
 2
 3
 4
 5

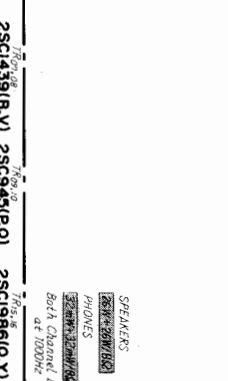
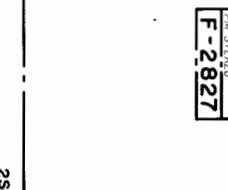
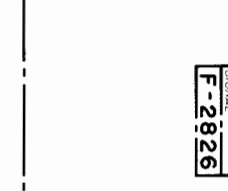
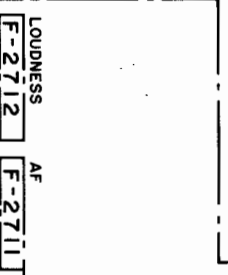
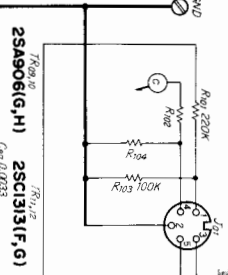

SPEAKERS
 PHONES
 Both Channel Drives
 at 1000Hz

8. THREADING OF DIAL CORD

- * If a dial cord is cut off or slips, replace it by following procedures.
As this unit uses 0.5 mm ϕ cord, please replace it with the same type certainly.
- * The length of dial cord is approximately 160 cm (65.3 inch).

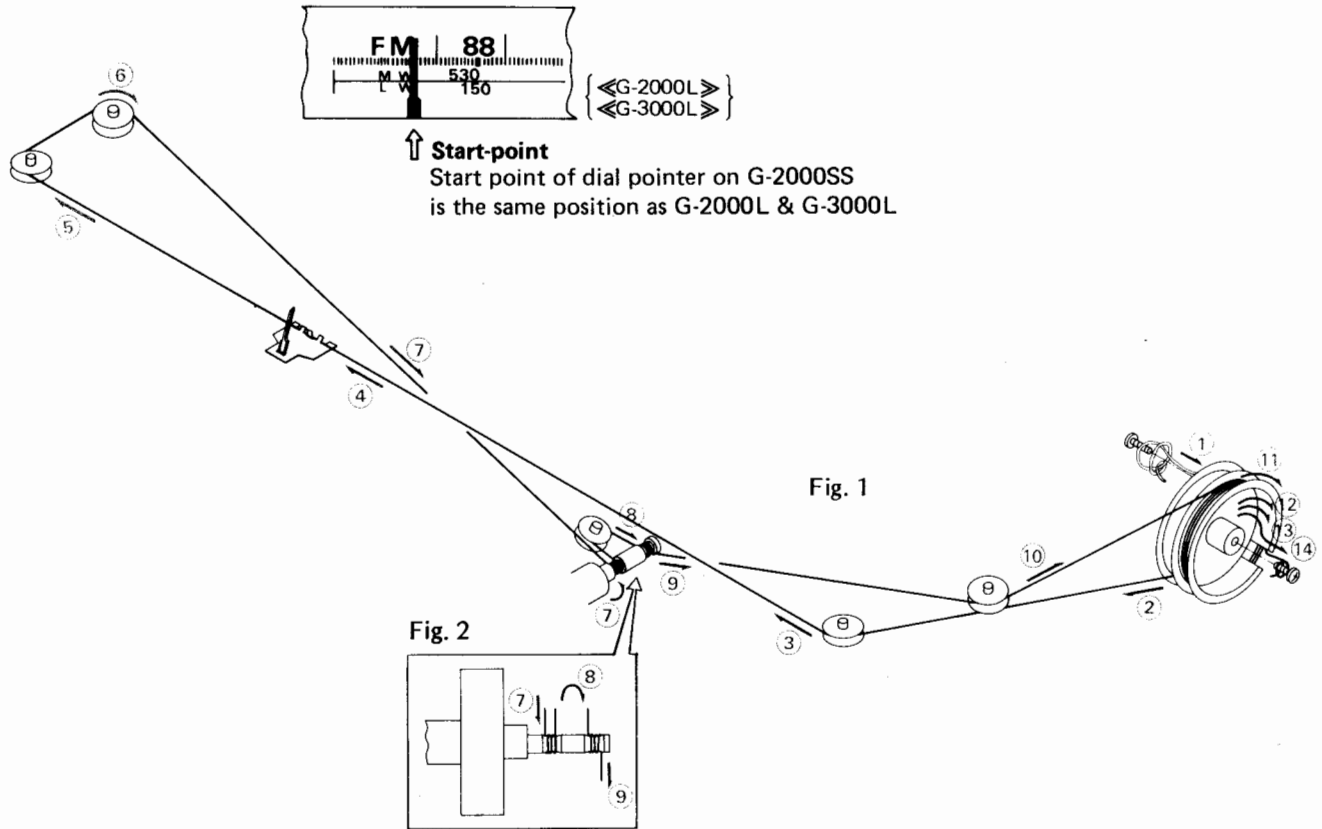

Threading of Dial Cord

Thread the dial cord in numerical order from 1 to 14 as Fig. 1.

- * Close the variable capacitor completely (Maximum Capacitance).

Attachment of Dial Pointer

- 1) Close the variable capacitor completely.
 - 2) Set the dial pointer to start point on dial scale as Fig. 2.
- * Confirm that the dial pointer runs smoothly on the dial scale by turning the turning shaft.

Stock No.	Description
6036050	Dial Cord (0.5 mm ϕ)
6146670	Dial Pulley

9. PACKING LIST

Parts No.	Stock No.	Description
1	9116143	Vinyl Cover
2	9028090	Stylofoam Packing
3	9009960	Carton Case <<G-2000SS>>
	9009970	Carton Case <<G-2000L>>
	9009940	Carton Case <<G-3000L>>
4	5996080	Curl Stopper

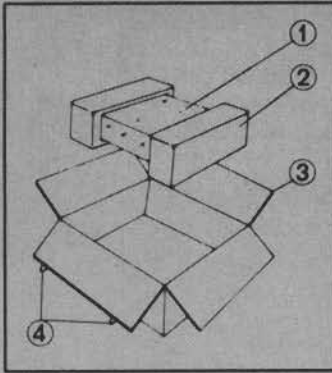

10. ACCESSORY PARTS LIST

Stock No.	Description
9203370	Operating Instructions <<G-2000SS>>
9203360	Operating Instructions <<G-2000L>>
9203350	Operating Instructions <<G-3000L>>
9237690	Schematic Diagram <<G-2000SS>>
9237680	Schematic Diagram <<G-2000L>>
9237670	Schematic Diagram <<G-3000L>>
3820100	FM Antenna

Sansui

SANSUI ELECTRONICS CORPORATION: 55-11 Queens Blvd. Woodside, N.Y. 11377 U.S.A.
333 West Alondra Blvd. Gardena, California 90247 U.S.A.
3036 Koapaka St. Honolulu, Hawaii 96819 U.S.A.

SANSUI AUDIO EUROPE N.V.: North Trade Bldg (9th floor) Noorderlaan 133-Bus 1,2030 Antwerp, Belgium
SANSUI AUDIO EUROPE S.A.: Arabella center, 6 Frankfurt AM Main, Lyoner Strasse 44-48, West Germany

SANSUI ELECTRIC COMPANY LTD.: 14-1, Izumi 2-chome, Suginamiku, Tokyo 168 Japan PHONE: (03) 323-1111/TELEX:232-2076