

# SERVICE MANUAL

## AM/FM STEREO RECEIVER

# SANSUI G-3500/301 G-4500/401

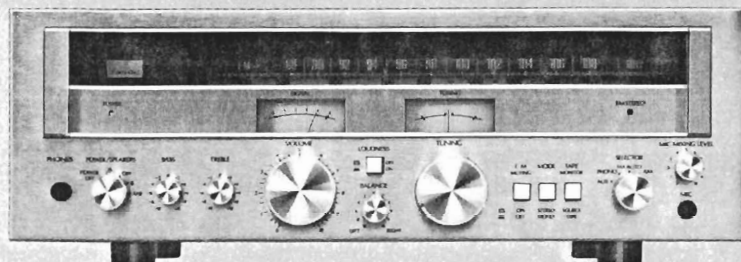

SANSUI ELECTRIC CO., LTD.

### SPECIFICATIONS

#### G-3500/301

##### Audio section

##### Power output

Min. RMS, both channels driven, from 20 to 20,000 Hz, with no more than 0.1% total harmonic distortion.

26 watts per channel into 8 ohms

Load impedance . . . . . 8 ohms

##### Total harmonic distortion

. . . . . less than 0.1% at or below rated min. RMS power output

Intermodulation distortion (70 Hz : 7 kHz = 4:1 SMPTE method) . . . . . less than 0.1%

##### Frequency response (at 1 watt)

. . . . . 10 to 50,000 Hz +1 dB -2 dB

##### RIAA curve deviation (PHONO)

. . . . . +0.5 dB -0.5 dB (30 to 15,000 Hz)

Damping factor . . . . . approximately 30 at 8-ohm load

##### Input sensitivity and impedance (1 kHz, for rated power output)

PHONO . . . . . 2.5 mV/47 kilohms

(Max. input capability; 200 mV at 1 kHz, less than 0.5% total harmonic distortion)

AUX, TAPE . . . . . 150 mV/47 kilohms

MIC . . . . . 8 mV/10 kilohms

##### Output level (1 kHz)

TAPE REC (pin jack) . . . . . 150 mV/47 kilohms

##### Channel separation (1 kHz, at rated power output)

PHONO . . . . . better than 50 dB

AUX . . . . . better than 50 dB

##### Hum and noise (short-circuit, A network)

PHONO . . . . . 75 dB

AUX . . . . . 95 dB

##### Controls

BASS . . . . . ±10 dB (50 Hz)

TREBLE . . . . . ±10 dB (10 kHz)

LOUDNESS (-30 dB) . . . . . 7 dB at 50 Hz

. . . . . 5 dB at 10 kHz

##### FM section

Tuning range . . . . . 88 to 108 MHz

##### Usable sensitivity

Mono IHF . . . . . 11.0 dBf (1.95 μV)

DIN . . . . . 1.2 μV

Stereo IHF . . . . . 19.0 dBf

##### 50 dB Quieting sensitivity

Mono . . . . . 15 dBf

Stereo . . . . . 38 dBf

##### Signal to noise ratio (at 65 dBf)

Mono . . . . . 71 dB

Stereo . . . . . 68 dB

##### Distortion (at 65 dBf)

Mono . . . . . less than 0.18% at 100 Hz  
less than 0.15% at 1,000 Hz  
less than 0.25% at 6,000 Hz

Stereo . . . . . less than 0.3% at 100 Hz  
less than 0.25% at 1,000 Hz  
less than 0.3% at 6,000 Hz

##### Alternate channel selectivity (at 400 kHz)

. . . . . 50 dB

##### Capture ratio . . . . . 1.3 dB

Image response ratio . . . . . 48 dB (at 98 MHz)

Spurious response ratio . . . . . 70 dB (at 98 MHz)

Stereo separation . . . . . 30 dB at 100 Hz

. . . . . 40 dB at 1,000 Hz

. . . . . 28 dB at 10,000 Hz

Frequency response . . . . . 30 to 15,000 Hz +0.5 dB -1.0 dB

##### Antenna input impedance

. . . . . 300 ohms balanced

. . . . . 75 ohms unbalanced

##### AM section

Tuning range . . . . . 530 to 1,600 kHz

##### Usable sensitivity (Bar antenna)

. . . . . 50 dB/m (300 μV/m)

Selectivity . . . . . 35 dB

Signal to noise ratio . . . . . 46 dB

##### Power requirements

Power voltage . . . . . 100, 120, 220, 240 V (50/60 Hz)

. . . . . 120 V (Usable 110 ~ 130 V)

. . . . . 60 Hz (for U.S.A. and Canada only)

##### Power consumption

Rated consumption . . . . . 90 watts 110 VA

Dimensions . . . . . 433 mm (17-1/16") W

. . . . . 153 mm (6-1/16") H

. . . . . 354 mm (14") D

Weight . . . . . 7.5 kg (16.5 lbs) net

. . . . . 8.9 kg (19.6 lbs) packed

\* Design and specifications subject to change without notice for improvements.

to be continued

## SPECIFICATIONS

### G-4500/401

**Audio section**  
**Power output**  
 Min. RMS, both channels driven, from 20 to 20,000 Hz, with no more than 0.1% total harmonic distortion.  
 40 watts per channel into 8 ohms  
**Load impedance** . . . . . 8 ohms  
**Total harmonic distortion**  
 . . . . . less than 0.1% at or below rated min. RMS power output  
**Intermodulation distortion** (70 Hz : 7 kHz = 4:1 SMPTE method)  
 . . . . . less than 0.1%  
**Frequency response** (at 1 watt)  
 . . . . . 10 to 50,000 Hz +1 dB -2 dB  
**RIAA curve deviation** (PHONO)  
 . . . . . +0.5 dB -0.5 dB (30 to 15,000 Hz)  
**Damping factor** . . . . . approximately 30 at 8-ohm load  
**Input sensitivity and impedance** (1 kHz, for rated power output)  
**PHONO** . . . . . 2.5 mV/47 kilohms  
 (Max. input capability; 200 mV at 1 kHz, less than 0.5% total harmonic distortion)  
**AUX, TAPE** . . . . . 150 mV/47 kilohms  
**MIC** . . . . . 8 mV/10 kilohms  
**Output level** (1 kHz)  
**TAPE REC** (pin jack) . . . . . 150 mV/47 kilohms  
**Channel separation** (1 kHz, at rated power output)  
**PHONO** . . . . . better than 50 dB  
**AUX** . . . . . better than 50 dB

**Hum and noise** (short-circuit, A network)  
**PHONO** . . . . . 75 dB  
**AUX** . . . . . 95 dB  
**Controls**  
**BASS** . . . . . ±10 dB (50 Hz)  
**TREBLE** . . . . . ±10 dB (10 kHz)  
**LOUDNESS** (-30 dB) . . . . . 7 dB at 50 Hz  
 . . . . . 5 dB at 10 kHz  
**FM section**  
**Tuning range** . . . . . 88 to 108 MHz  
**Usable sensitivity**  
**Mono IHF** . . . . . 11.0 dBf (1.95 μV)  
**DIN** . . . . . 1.2 μV  
**Stereo IHF** . . . . . 19.0 dBf  
**50 dB Quieting sensitivity**  
**Mono** . . . . . 15 dBf  
**Stereo** . . . . . 38 dBf  
**Signal to noise ratio** (at 65 dBf)  
**Mono** . . . . . 71 dB  
**Stereo** . . . . . 68 dB  
**Distortion** (at 65 dBf)  
**Mono** . . . . . less than 0.18% at 100 Hz  
 . . . . . less than 0.15% at 1,000 Hz  
 . . . . . less than 0.25% at 6,000 Hz  
**Stereo** . . . . . less than 0.3% at 100 Hz  
 . . . . . less than 0.25% at 1,000 Hz  
 . . . . . less than 0.3% at 6,000 Hz  
**Alternate channel selectivity** (at 400 kHz)  
 . . . . . 50 dB

**Capture ratio** . . . . . 1.3 dB  
**Image response ratio** . . . . . 48 dB (at 98 MHz)  
**Spurious response ratio** . . . . . 70 dB (at 98 MHz)  
**Stereo separation** . . . . . 30 dB at 100 Hz  
 . . . . . 40 dB at 1,000 Hz  
 . . . . . 28 dB at 10,000 Hz  
**Frequency response** . . . . . 30 to 15,000 Hz +0.5 dB -1.0 dB  
**Antenna input impedance**  
 . . . . . 300 ohms balanced  
 . . . . . 75 ohms unbalanced  
**AM section**  
**Tuning range** . . . . . 530 to 1,600 kHz  
**Usable sensitivity** (Bar antenna)  
 . . . . . 50 dB/m (300 μV/m)  
**Selectivity** (±10 kHz) . . . . . 35 dB  
**Signal to noise ratio** . . . . . 46 dB  
**Power requirements**  
**Power voltage** . . . . . 100, 120, 220, 240 V (50/60 Hz)  
 . . . . . 120 V (Usable 110 ~ 130 V)  
 . . . . . 60 Hz (for U.S.A. and Canada only)  
**Power consumption**  
**Rated consumption** . . . . . 115 watts 145 VA  
**Dimensions** . . . . . 433 mm (17-1/16") W  
 . . . . . 153 mm (6-1/16") H  
 . . . . . 354 mm (14") D  
**Weight** . . . . . 8.1 kg (17.9 lbs) net  
 . . . . . 9.5 kg (20.9 lbs) packed

\* Design and specifications subject to change without notice for improvements.

## 1. OPERATIONS

### Pop-noise preventive circuit

In order to prevent the annoying pop-noise to the loudspeakers at turning the power of the amplifier ON, the pop-noise preventive circuit adopted in the G-4500/401 is the combination of the conventional driver-voltage delay type used in the power supply (rectifier) circuit and the NF delay type pop-noise preventive circuits. The configuration of NF delay type pop-noise preventive circuit is shown in Fig. 1.

In this circuit, the switching (ON-OFF) of the transistor TR05 is made by the time constant of the capacitor C40 and resistor R88. Thereby the NF resistor, R51 is controlled, and the gain of the main amplifier stage is lowered when TR05 is ON, thus the voltage drift (transient voltage) of the main amplifier at turning the power ON does not appear on the speaker terminals for very short period of time. In other words, at the instant that the power is turned ON, the voltage at the point A rises up to +13V, then the voltage decreases by means of the time constant of C40 and R88 as shown in Fig. 2. At this time, the diode D11 is inversely biased, consequently, the potential voltage of the point B is 0V as Fig. 3. Because of this, TR05 turns to the cut-off, thus the NF resistor, R51 acquires such a state as its resistance value becomes equivalently very large, which decreases the gain of the power amplifier. When the charge of the C40 is completed, the voltage of the point B (see Fig. 3) becomes negative, as a result, the diode D11 is biased. Therefore, TR05 is turned ON, and the circuit of this equipment is normally operated approximately 2 seconds after the power is turned ON to prevent the pop-noise which flows to loudspeakers.

Fig. 1

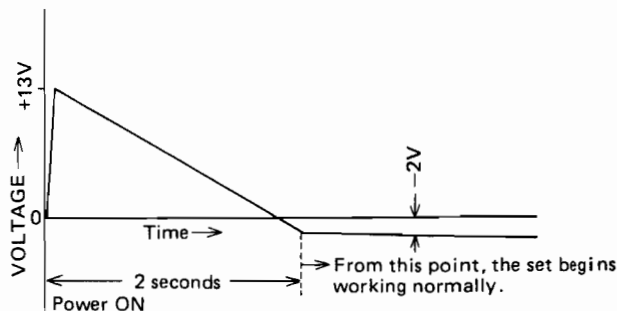
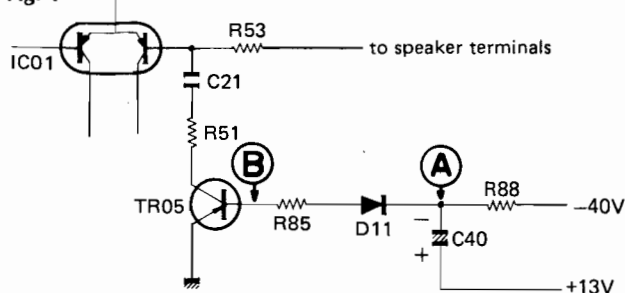

Fig. 2 Voltage variation during a certain period of time at A

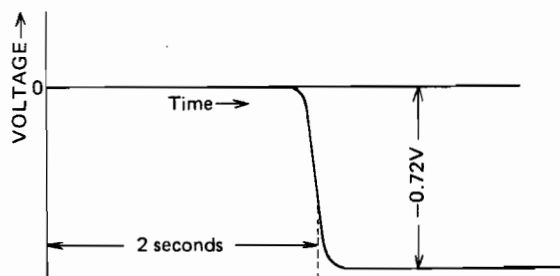
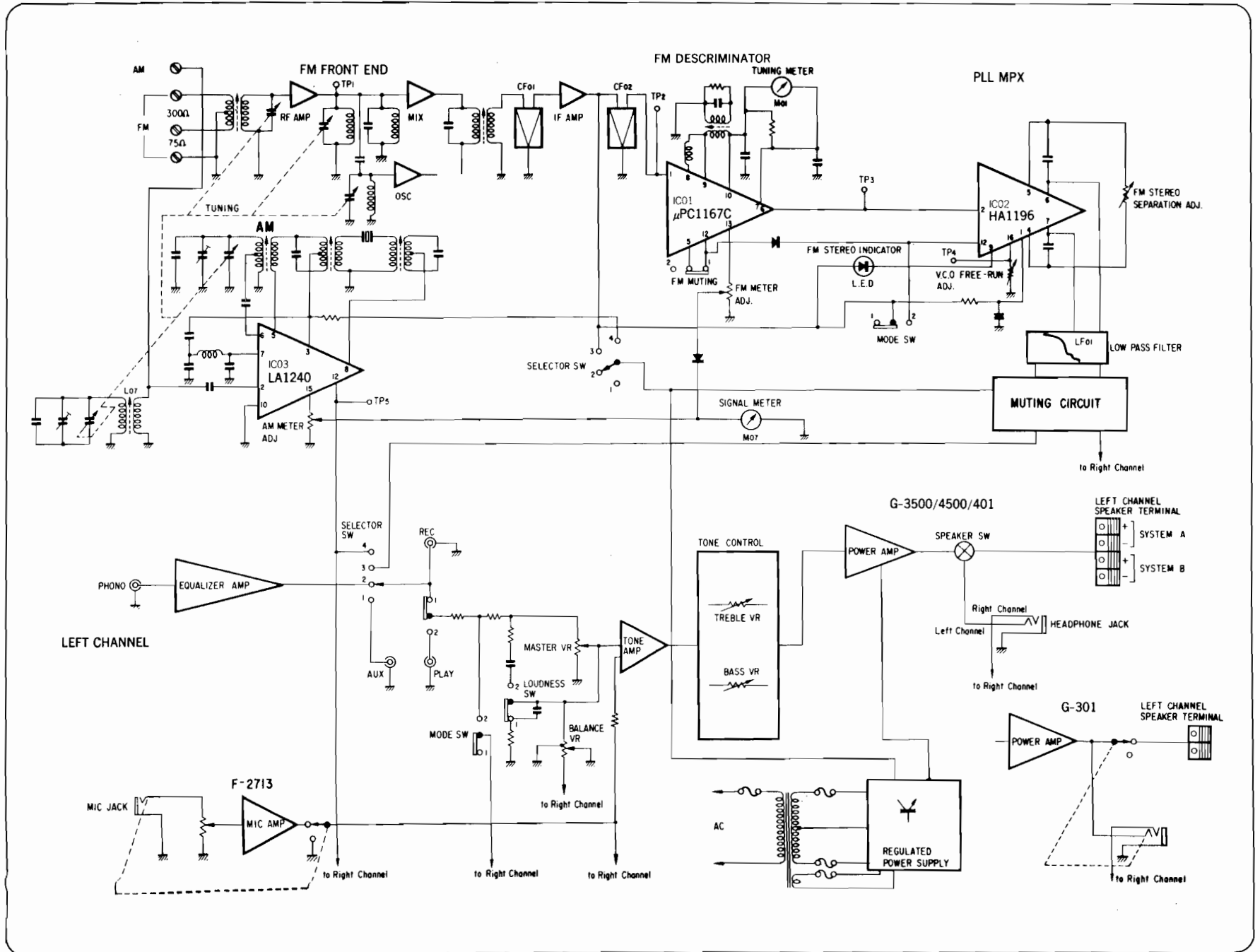

Fig. 3 Voltage variation at B

# 2. BLOCK DIAGRAM



### 3. ADJUSTMENTS

\* Refer to illustration of F-2924 circuit board on next page.

#### 3-1. FM Adjustment

- Note: 1. Selector . . . . . FM AUTO  
2. FM Muting Switch . . . . . OFF

3. Connection . . . . . Connect the output of genescope to TP through 100 pF ceramic capacitor.

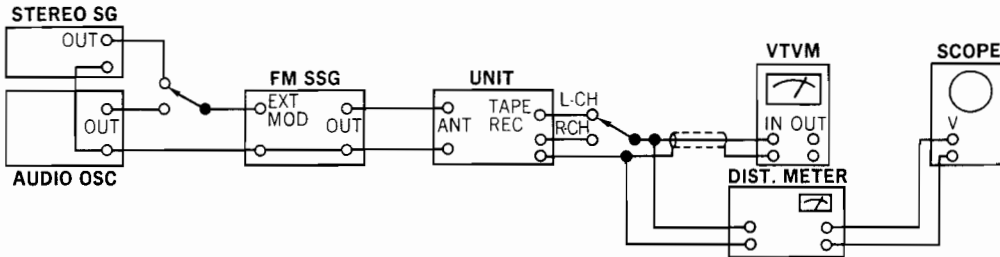
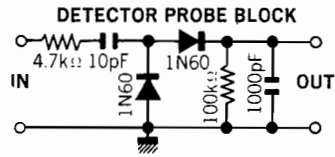
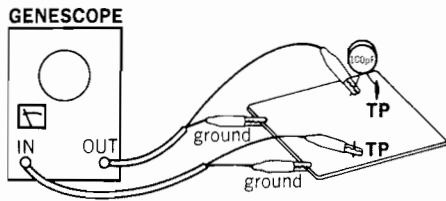

#### 1) FM IF Adjustment & Dial Calibration

STEP	SUBJECT	FEED SIGNAL		MEASURE OUTPUT	ADJUST	ADJUST FOR	REMARKS
		FROM	TO				
1.	IF Coil	Output 80 dB Genescope	TP01 F-2924	TP02 F-2924 Use Detector Probe	T01 F-2924	Max. IF waveform	
2.	Discriminator Coil	Same as above	Same as above	TP03 F-2924	T02, T03 F-2924	Steep linearity of S curve Make symmetrical S curve	
	Discriminator Coil In case of using Dist Meter	98 MHz ANT Input 65 dBf (59.8 dB) 1000 Hz (100% MOD) FM SSG	ANT terminal 300Ω	REC terminal Dist Meter	T02, T03 F-2924	Min. T.H.D.	
3.	Tuning Meter	98 MHz ANT Input 65 dBf (59.8 dB) 1000 Hz (100% MOD) FM SSG	Same as above	Tuning Meter	T02 F-2924	Center on Meter	
4.	90 MHz Dial Calibration	90 MHz ANT Input 65 dBf (59.8 dB) 1000 Hz (100% MOD) FM SSG	Same as above	REC terminal VTVM & Scope	L03 F-2924	Max. indication on Signal meter & Center indication on Tuning meter	
	106 MHz Dial Calibration	106 MHz ANT Input 65 dBf (59.8 dB) 1000 Hz (100% MOD) FM SSG	Same as above	Same as above	TC03 F-2924		
5.	90 MHz RF Adj.	90 MHz ANT Input Minimum value with sine wave 1000 Hz (100% MOD) FM SSG	Same as above	Same as above	L01, L02 F-2924	Same as above	
	106 MHz RF Adj.	106 MHz ANT Input Minimum value with sine wave 1000 Hz (100% MOD) FM SSG	Same as above	Same as above	TC01, TC02 F-2924	Same as above	
6.	Signal Meter Volume	98 MHz ANT Input 65 dBf (59.8 dB) 1000 Hz (100% MOD) FM SSG	Same as above	Signal Meter	VR03 F-2924	4.3 on Meter	

### 3-2. AM IF Adjustment & Dial Calibration

Note: 1. Selector ..... AM

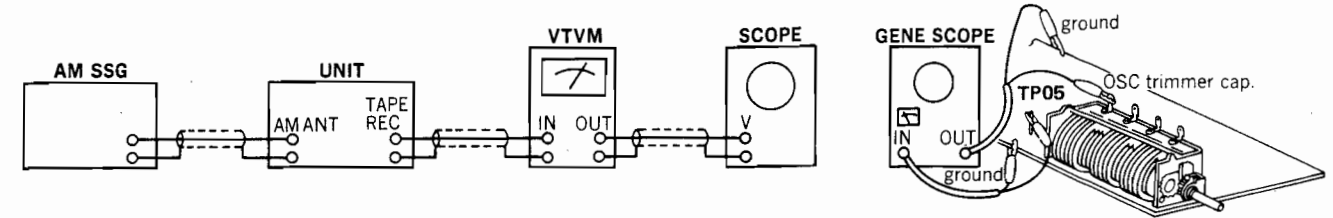

STEP	SUBJECT	FEED SIGNAL		MEASURE OUTPUT	ADJUST	ADJUST FOR	REMARKS
		FROM	TO				
1.	IF Coil	Genescope Output level 70 dB	TC04 F-2924	TP05 F-2924	T05 L10 F-2924	Max. IF waveform	
2.	600 kHz Dial Calibration	600 kHz ANT Input 60 dB 400 Hz (MOD 30%) AM SSG	AM ANT terminal	REC terminal L or R-CH VTVM & Scope	T04 F-2924	Max. indication on signal meter	
	1400 kHz Dial Calibration	1400 kHz ANT Input 60 dB 400 Hz (MOD 30%) AM SSG	Same as above	Same as above	TC04 F-2924	Same as above	
3.	600 kHz RF Adj.	600 kHz ANT Input 50 dB 400 Hz (MOD 30%) AM SSG	Same as above	Same as above	Bar Antenna L07	Same as above	
	1400 Hz RF Adj.	1400 kHz ANT Input 50 dB 400 Hz (MOD 30%) AM SSG	Same as above	Same as above	TC05 F-2924	Same as above	
4.	Signal Meter volume	1000 kHz ANT Input 80 dB 400 Hz (MOD 30%) AM SSG	Same as above	Signal Meter	VR04 F-2924	4.5 on meter	

### 2) FM STEREO Adjustment

Note: 1. Mode ..... STEREO

STEP	SUBJECT	FEED SIGNAL		MEASURE OUTPUT	ADJUST	ADJUST FOR	REMARKS
		FROM	TO				
1.	PLL VCO Adj.	98 MHz ANT Input 65 dBf (59.8 dB) FM SSG Pilot 19 kHz (9% MOD) SUB 1 kHz + Pilot (100% MOD) STEREO SG	ANT terminal 300Ω	Stereo indicator	VR01 F-2924	Light indicator	Adjust the VR01 within center of lighting level.
	PLL VCO Adj. In case of using Freq. counter	98 MHz ANT Input 65 dBf (59.8 dB) FM SSG No mode	Same as above	TP04 F-2924 Use Freq. counter	VR01 F-2924	76 kHz ± 150 Hz	
2.	Separation	98 MHz ANT Input 65 dBf (59.8 dB) FM SSG Pilot 19 kHz (9% MOD) R (or L) Mode 1 kHz + Pilot (100% MOD) STEREO SG	Same as above	REC terminal R-CH → L-CH VTVM & Scope	VR02 F-2924	Set -34 dB	Confirm separation L-CH → R-CH (-34 dB)

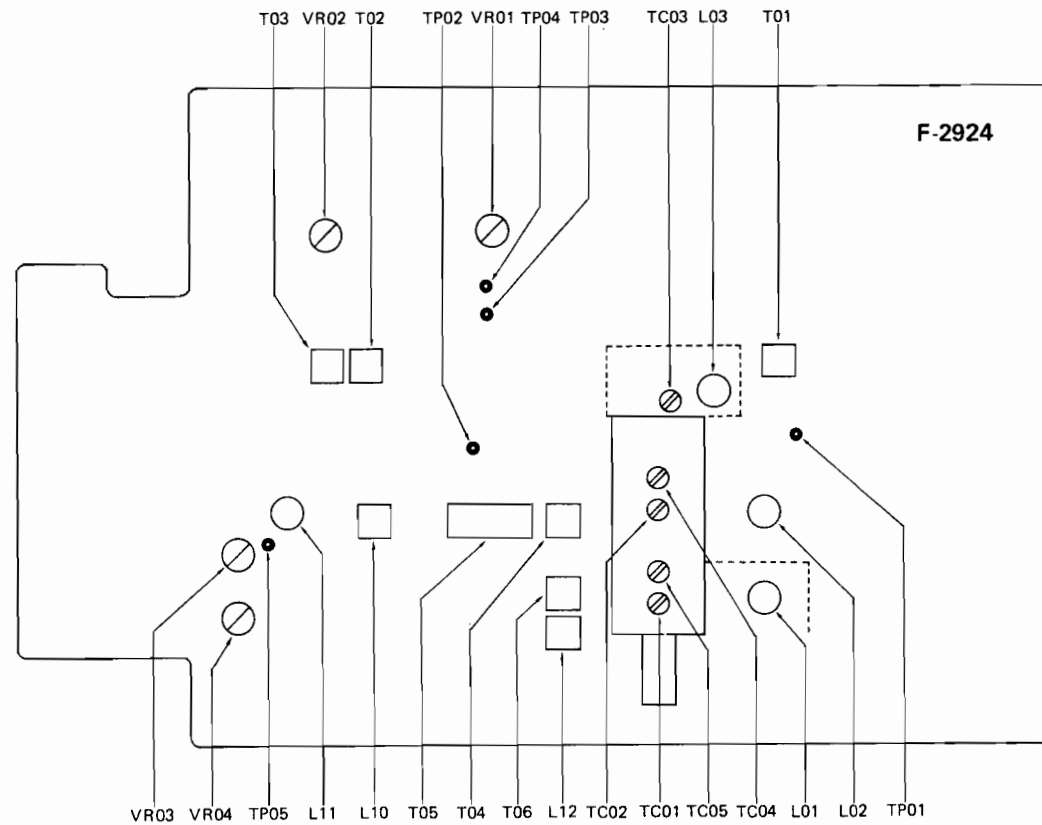

### 3-3. Bias Current Adjustment (See the Picture of Top View on page 8)

1. Confirm AC power supply voltage (100 V, 120 V, 220 V or 240 V).
  2. Master Volume ..... Minimum
  3. Room Temperature ..... 18°C ~ 28°C (65°F ~ 83°F)
  4. Before this adjustment, turn bias adjustment volumes of VR04 and VR05 fully counterclockwise, then run this unit for more than three minutes.
- Note: For this adjustment, measure the voltage between the lead + (plus) side of R77 (R78) and the lead - (minus) side of R79 (R80) on both channels.

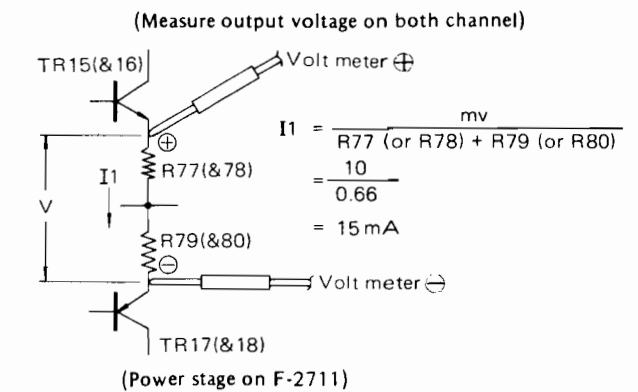

#### \* NEW MEASUREMENT FOR FM

Input signal level under the provision of IHFM-T-200, a new measurement method is indicated by available power ratio "dBf". To obtain approximate available power ratio "dBf", abstract 0.8 from attenuator indication of general FMSG (open load indication type); however, the conventional measurement, IHFM-T-100 is designated together too.

The way of modulation on IHFM-T-200 is shown below.

	modulation frequency	modulation mode	modulation factor
FM MONO	1000 Hz		100%
FM STEREO	1000 Hz	SUB	Pilot 9% Pilot + SUB 100%

\* The relation between the standard input 65 dBf of IHFM-T-200 and the former indication "dB" is shown below.

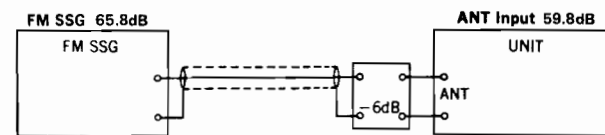

STEP	SUBJECT	EQUIPMENT	MEASURE OUTPUT	ADJUST	ADJUST FOR
1	Bias Current L-CH	DC Volt meter	* See above	VR04 F-2711	10 mV ± 1 mV (15 mA)
2	Bias Current R-CH	DC Volt meter	* See above	VR05 F-2711	10 mV ± 1 mV (15 mA)



# 4. PARTS LOCATION & PARTS LIST

Since some of capacitors and resistors are omitted from parts lists in this Service Manual, refer to the Common Parts List for capacitors & resistors which was appended previously to each Sansui Manual.

4-1. F-2924 AM/FM Tuner & FM MPX Circuit Board (Stock No. 7521861)

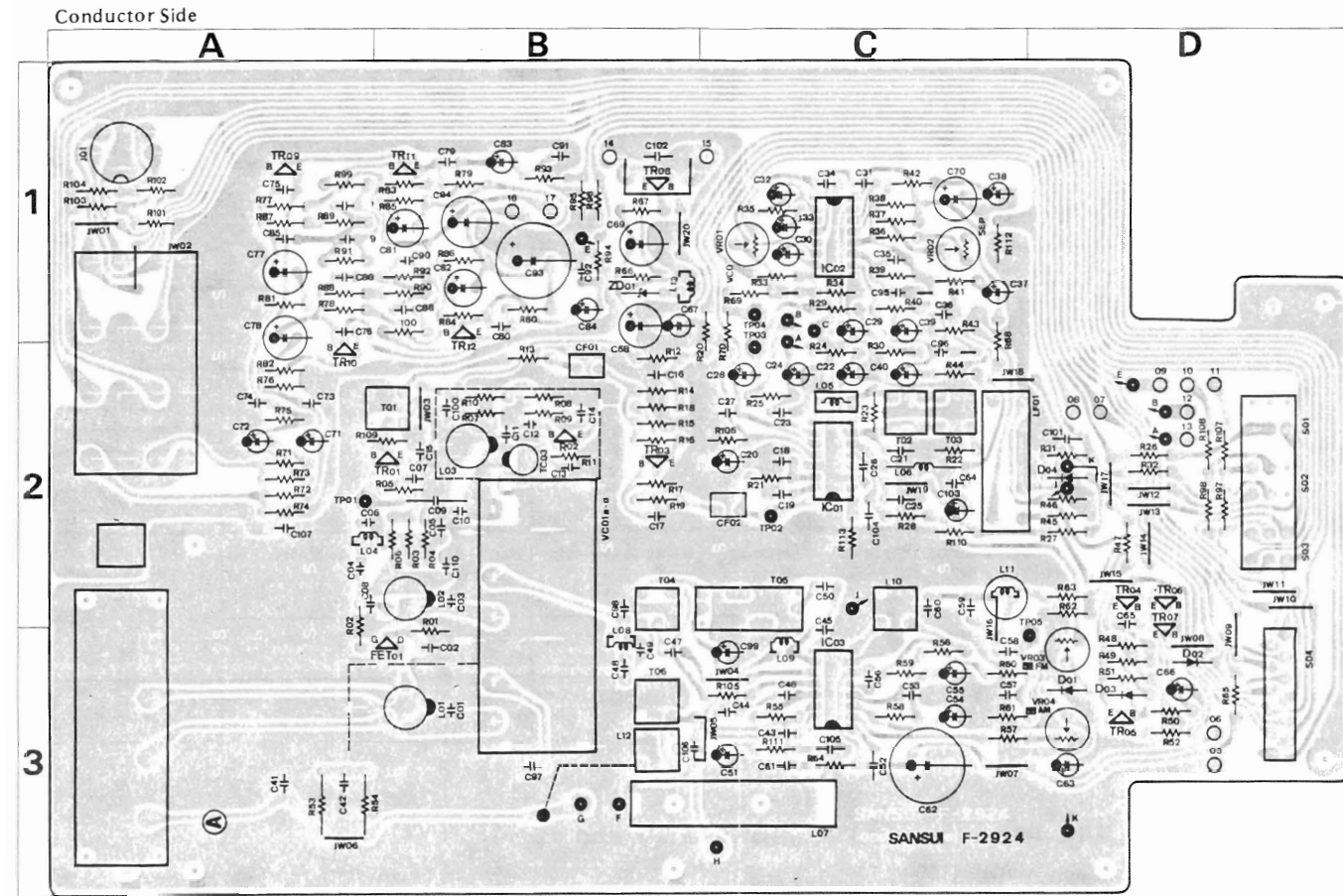

Parts List

Parts No.	Stock No.	Description	Position
<b>•Transistors</b>			
TR01, 02	0305801, 2	2SC1047 B, C	2B
TR03	0306341, 2	2SC1674 L, K	2B
TR04	0305951, 2	2SC945 Q, P	2D
TR05	0300470	2SA726W F	3D
TR06, 07	0306581, 2	2SC1634	2D, 3D
TR08	0308450, 1	2SD356 C, D	1B
TR09, 1C	0300900, 1	2SA906 G, H	1A, 2A
TR11, 12	0306070, 1	2SC1313 F, G	1B
<b>•ICs</b>			
IC 01	0360750	μPC1167C	2C
IC 02	0360320	HA1196	1C
IC 03	0360800	LA1240	3C
<b>•FET</b>			
FT01	0370172	2SK49 (H)	3B
<b>•Diodes</b>			
D 01 ~ 04	0311160	1S2473D	3D, 2D
<b>•Zener Diodes</b>			
ZD01	0315970	EQA01-13R	1B
C 01 ~ 03	0669347	12pF 50V C.C.	3B, 2B
C 04	0669210	10pF 50V C.C.	2A
C 06	0669503	3pF 50V C.C.	2A
C 09	0679012	15pF 500V	2B
<b>Gimmick Capacitor</b>			
C 10	0669355	20pF 50V C.C.	2B
C 11, 13	0669210	10pF 50V C.C.	2B
C 32	0573159	1.5μF 35WV T.C.	1C
C 33	0573339	3.3μF 35WV T.C.	1C
C 34	0629005	360pF 50V P.C.	1C
C 49	0620301	300pF 50V P.C.	3B
C 89, 90	0620161	160pF 50V P.C.	1A, 1B
C 95, 96	0620561	560pF 50V P.C.	1C, 2C
C 97	0669563	3pF 50V C.C.	3B
C 98	0669400	15pF 50V C.C.	2B
L 01	4200720	Antenna Coil (FM)	3B
L 02	4210340	RF Coil	2B

Parts No.	Stock No.	Description	Position
L 03	4220400	0 S.C. Coil	2B
L 04	4900140	1μH Inductor Coil	2A, B
L 05	4290300	18μH Inductor Coil	2C
L 06	4290011	Peaking Coil 3.5μH	2C
L 07	4200750	Antenna Coil (AM)	3C
L 08	4900140	1μH Inductor Coil	3B
L 09	4900110	100μH Inductor Coil	3B
L 10	4230620	IF Coil (AM)	2C
L 11	4900060	22mH Inductor	2C
L 13	4900110	100μH Inductor Coil	1B
T 01	4235930	IF Coil (FM)	2B
T 02	4235990, 1	IF Coil	2C
T 03	4236000, 1	IF Coil	2C
T 04	4220650	OSC Coil (AM)	2B
T 05	0910370	Ceramic Filter (AM)	2C
T 06	4230620	IF Coil	3B
CF 01, 02	0910380	Ceramic Filter (FM)	2B, 2C
LF 01	0910220	Low Pass Filter	2C
VR01	1034250	4.7kΩ (B) VCO Free Run Adjusting VR	1C
VR02	1035210	220kΩ (B) Stereo Separation Adjusting VR	1C
VR03	1035150	22kΩ (B) FM Meter Adjusting VR	3C, D
VR04	1035110	4.7kΩ (B) AM Meter Adjusting VR	3D
S 01	1131060, 1	Push Switch, FM muting	2D
S 02	1101840	Rotary Switch, selector	2D
VC01	1220210	AM FM Variable Capacitor	2B
TC03	1230090	Trimmer Capacitor	2B
J 01	2090030	5P DIN Socket	1A
	2210330	4P Antenna Terminal	
	2230180	Ground Terminal	
	2200410, 1	8P Input Terminal	

4-2. F-2711 Pre/Main & Power Supply Circuit Board (Stock No. 7572141/G-3500) (Stock No. 7572081/G-301) (Stock No. 7572151/G-4500) (Stock No. 7572131/G-401)

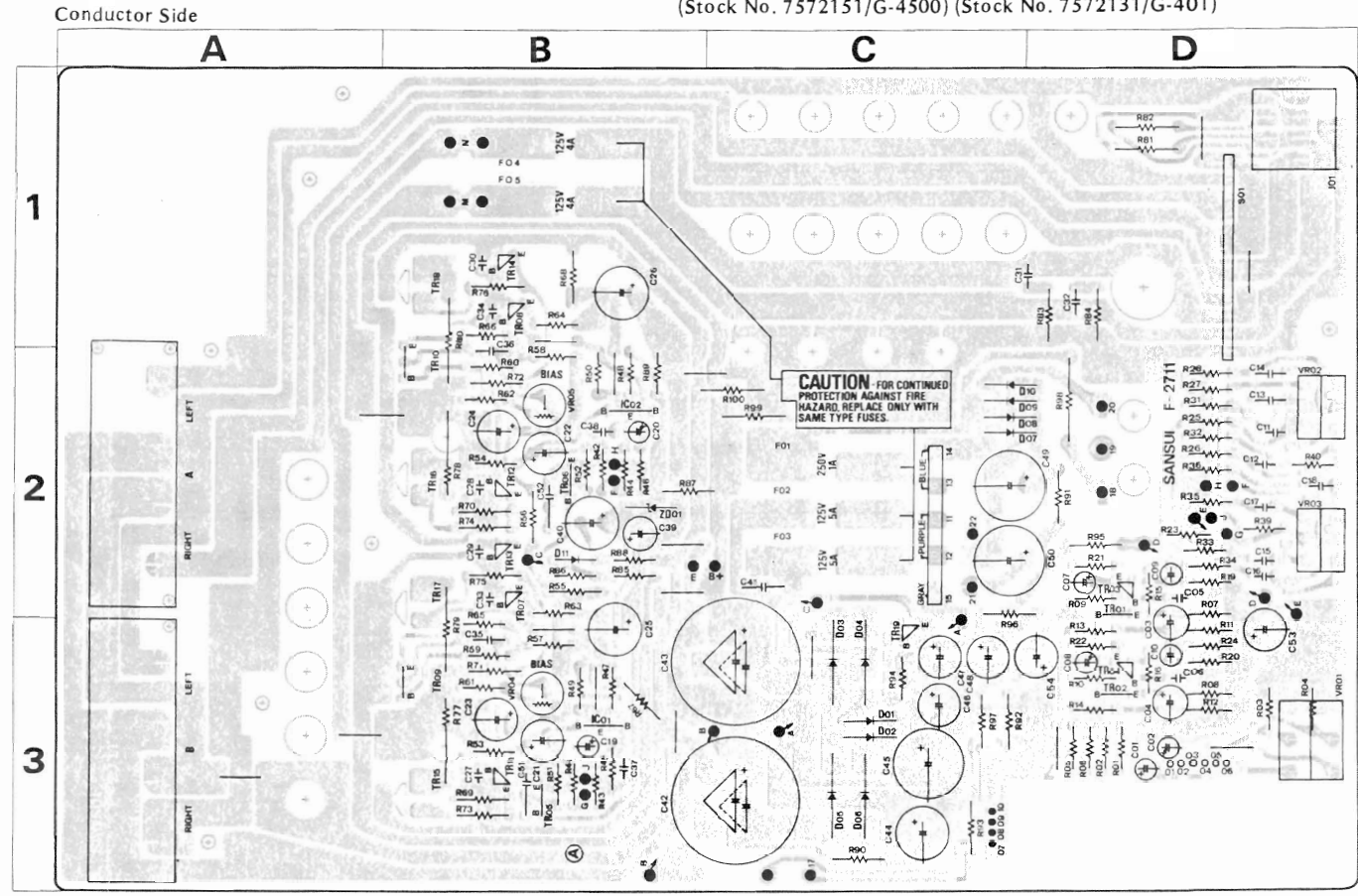

Parts List

Parts No.	Stock No.	Description	Position
<b>•Transistors</b>			
TR01, 02	0300470, 1	2SA726W F, G	2D, 3D
TR03, 04	0306070, 1	2SC1313 F, G	2D, 3D
TR07, 08	0306521, 2	2SC1439 B, V	2B, 1B
TR09, 10	0305951, 2	2SC945 P, Q	3B, 2B
TR11, 12	0306521, 2	2SD438 E, F	3B, 2B
TR13, 14	0303361, 2	2SB560 E, F	2B, 1B
TR15, 16	0306541, 2	2SC1986 Q, Y	3B, 2B
TR17, 18	0300911, 2	2SA771 Q, Y	2B, 1B
TR19	0306521, 2	2SD438 E, F	3C
<b>•ICs</b>			
IC 01, 02	0360290, 1	2SA798 E, F	3B, 2B
<b>•Diodes</b>			
D 01, 02	0310340	10D1	3C
D 03 ~ 06	0311530	30D2	3C
D 07 ~ 10	0310340	10D1	2C
<b>•Zener Diode</b>			
ZD01	0315970	EQA01-13R	2B
C 41	0665103	10,000pF 500V C.C.	2C
R 55, 56	0210182	1.8kΩ 1/2W N.I.R.	2B
R 67, 68	0192101	100Ω 1/2W F.R.	3B, 1B
R 69 ~ 72	0192221	220Ω 1/2W F.R.	3B, 2B
R 73 ~ 76	0192699	6.8Ω 1/2W F.R.	1, 2B
R 77 ~ 80	0212338	0.33Ω 2W N.I.R.	1, 2B
R 81, 82	0211221	220Ω 1W N.I.R.	1D
R 83, 84	0210479	4.7Ω 1/2W N.I.R.	1D
R 91	0192220	22Ω 1/2W F.R.	2D
VR01	1011130, 1	250kΩ (B) x 2 Level Volume	3D
VR02	1015300, 1	100kΩ x 2 Bass Volume	2D
VR03	1015300, 1	100kΩ x 2 Treble Volume	2D
VR04, 05	1035050	470Ω Volume, bias current	
F 01	0432220	1A 250V Fuse Holder (Large)	
	2310220	4P Outlet Terminal	
	2210340		

Parts No.	Stock No.	Description	Position
<b>&lt;G-3500/301&gt;</b>			
C 42, 43	0549009	6,800μF 35V E.C.	
R 87	0210182	1.8kΩ 1/2W N.I.R.	2B
R 90	0210271	270Ω 1/2W N.I.R.	3C
R 92	0210681	680Ω 1/2W N.I.R.	3C
R 93	0210331	330Ω 1/2W N.I.R.	3C
R 95	0210681	680Ω 1/2W N.I.R.	2D
R 96	0210151	150Ω 1/2W N.I.R.	2C
R 97	0210271	270Ω 1/2W N.I.R.	3C
R 99, 100	0211222	2.2kΩ 1W N.I.R.	2C
<b>&lt;G-4500/401&gt;</b>			
<b>•Transistors</b>			
TR05, 06	0300510, 1	2SA733 P, Q	3B, 2B
<b>•Diodes</b>			
D 11	0311160	1S2473D	2B
C 42, 43	0549116	6,800μF 50V E.C.	
R 87	0210222	2.2kΩ 1/2W N.I.R.	2B
R 90	0210471	470Ω 1/2W N.I.R.	3C
R 92	0210102	1kΩ 1/2W N.I.R.	3C
R 93	0210681	680Ω 1/2W N.I.R.	3C
R 95	0210102	1kΩ 1/2W N.I.R.	2D
R 96	0210271	270Ω 1/2W N.I.R.	2C
R 97	0210681	680Ω 1/2W N.I.R.	3C
R 99, 100	0211272	2.7kΩ 1W N.I.R.	2C
F 02, 03	0432500	7A 125V Fuse	2C
<b>&lt;G-3500/4500/401&gt;</b>			
S 01	1101850	SP Selector Switch	1D
<b>&lt;G-301&gt;</b>			
J 01	2430340	Headphone Jack Socket	

\* The circuit boards, F-2708, F-2709, F-2710, F-2712, F-2713 and F-2716 are not supplied as the assembled, the individual parts on the circuit boards, however, are provided for orders.

#### 4-3. F-2708 Circuit Board for Signal Meter

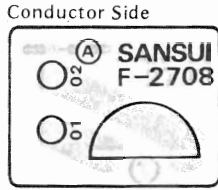

##### Parts List

Parts No.	Stock No.	Description
M01	4301230, 1	Signal Meter

#### 4-4. F-2709 Circuit Board for Tuning Meter

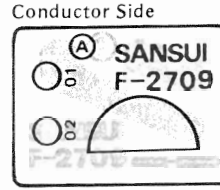

##### Parts List

Parts No.	Stock No.	Description
M02	4301240, 1	Tuning Meter

#### 4-5. F-2710 Circuit Board for Stereo Indicator

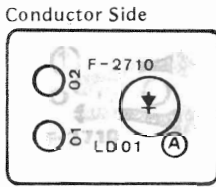

##### Parts List

Parts No.	Stock No.	Description
LD01	0319060	Light Emitted Diode

#### 4-6. F-2712 Loudness Circuit Board

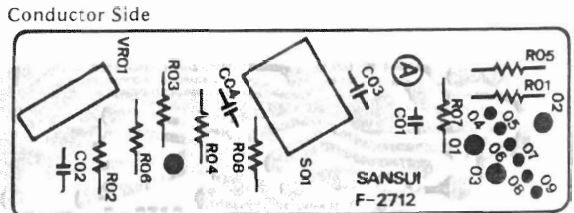

##### Parts List

Parts No.	Stock No.	Description
VR01	1005350, 1	250k $\Omega$ (B) $\times$ 2 Balance Volume
S 01	1131490, 1	Push Switch, loudness

#### 4-7. F-2713 Microphone Amp Circuit Board

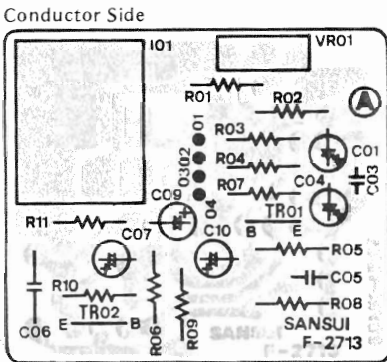

##### Parts List

Parts No.	Stock No.	Description
*Transistors		
TR01	0300470, 1	2SA726W F, G
TR02	0306070, 1	2SC1313 F, G
VR01	1005340, 1	20k $\Omega$ (A) Mixing Volume
J 01	2430330	Mic. Jack Socket

#### 4-8. F-2716 Voltage Selector Circuit Board

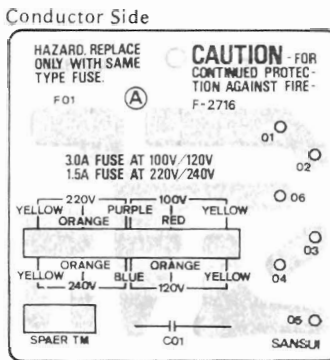

##### Parts List

Parts No.	Stock No.	Description
C 01	0659802	0.0047 $\mu$ F 150V C.C.
F 01	0432230	1.5A 250V
	0432260	3A 250V
	0432250	2.5A 250V
	0432290	5A 125V
F 881	0435110	1.25A 250V EU, BS G-301
	0435130	2A 250V EU, BS G-401
	2310220	Fuse Holder (Large)

### Abbreviations

C.R.	: Carbon Resistor	E.C.	: Electrolytic Capacitor
S.R.	: Solid Resistor	BP.E.C.	: Bi-Polar Electrolytic Capacitor
Ce.R.	: Cement Resistor	C.C.	: Ceramic Capacitor
M.R.	: Metal Film Resistor	Mi.C.	: Mica Capacitor
F.R.	: Fusing Resistor	O.C.	: Oil Capacitor
N.I.R.	: Non-Inflammable Resistor	P.C.	: Polystyrene Capacitor
M.C.	: Mylar Capacitor	T.C.	: Tantalum Capacitor

**NOTE:**

◆ **Changing Power Supply Voltage: (This is applicable for universal type).**

Your unit is adjusted to operate at the correct power supply voltage of your area prior to shipment from our factory. If you move to an outside country after purchasing it or send it as a gift to a friend living in an area where the voltage is different, it may be necessary to operate at the correct power supply voltage.

\* When necessary, remove the bonnet from the unit and reconnect leads from power supply circuit board as described below in accordance with the required voltage (100 V, 120 V, 220 V or 240 V).

1) For 100V

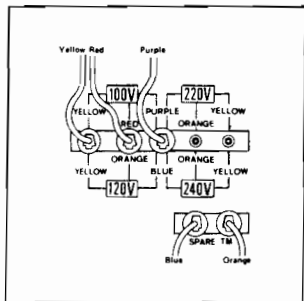

2) For 120V

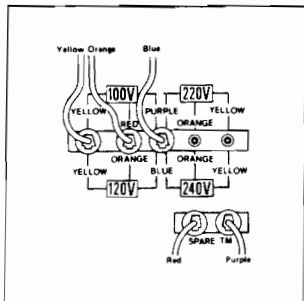

3) For 220V

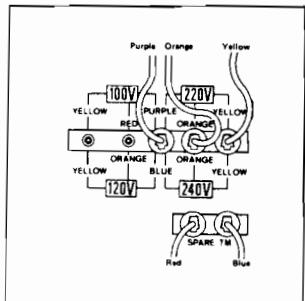

4) For 240V

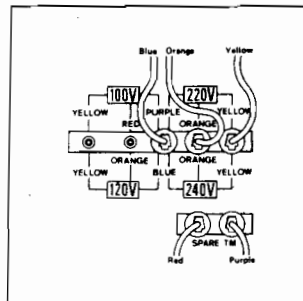

## 5. PARTS REPLACEMENT

### 5-1. Square Knobs of Loudness, FM Muting, Mode & Tape Monitor

1. Take off a wood bonnet, front & inside panels.
2. Then, pull out knobs to which are not glued as Fig. 1.

### 5-2. Tuning & Signal Meter

1. Complete 1. & 2. above.
2. Take off the meter as Fig. 2, then put it back into same place until snapped.

### 5-3. Master Volume

1. Take off the two panels and one nut for master volume.
2. Then, unsolder six points installing the master volume on pattern side of F-2711 printed board.

Fig. 1

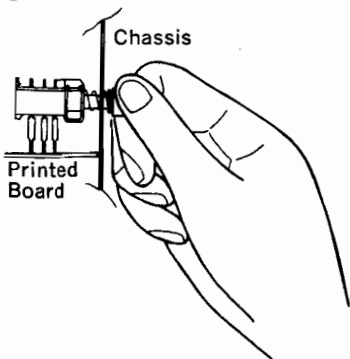

Fig. 2

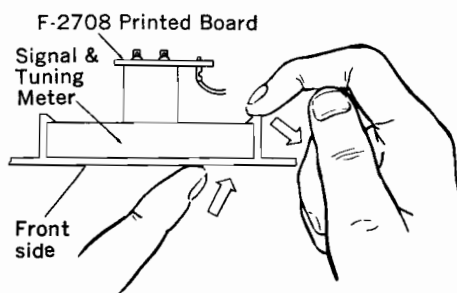
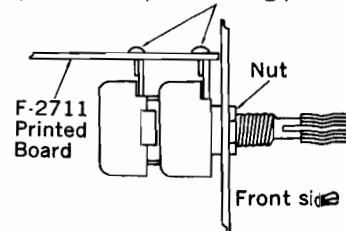

Fig. 3 Level Volume (Bottom side) Soldering points





## 6. OTHER PARTS

6-1. Front View

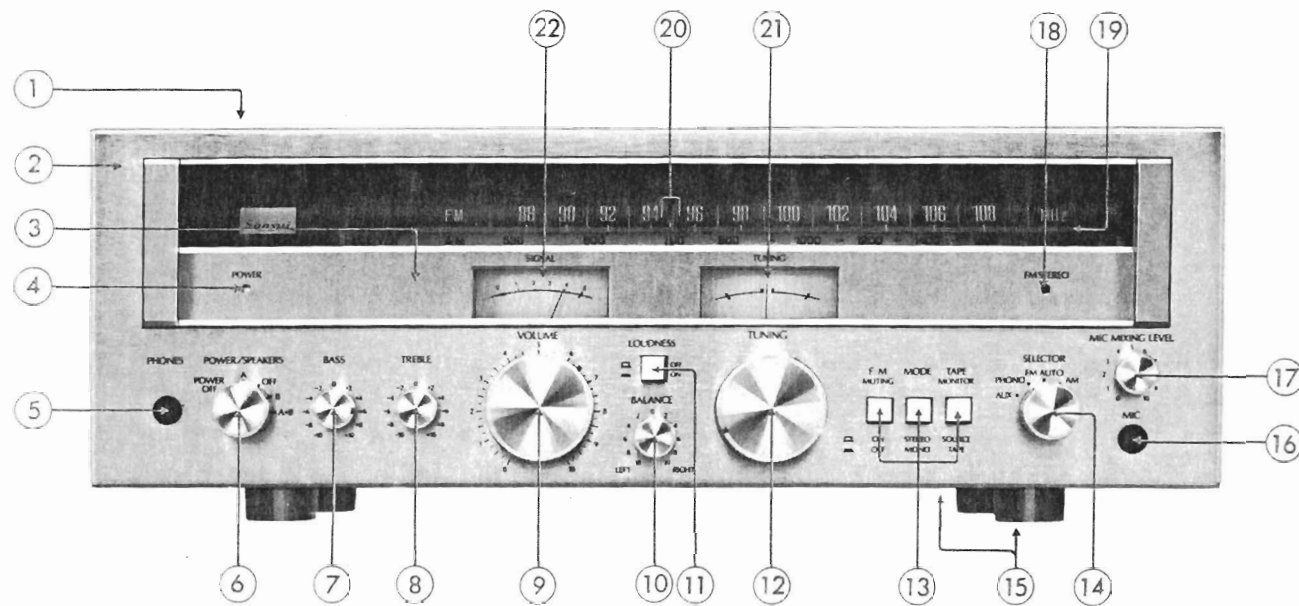

6-2. Top View

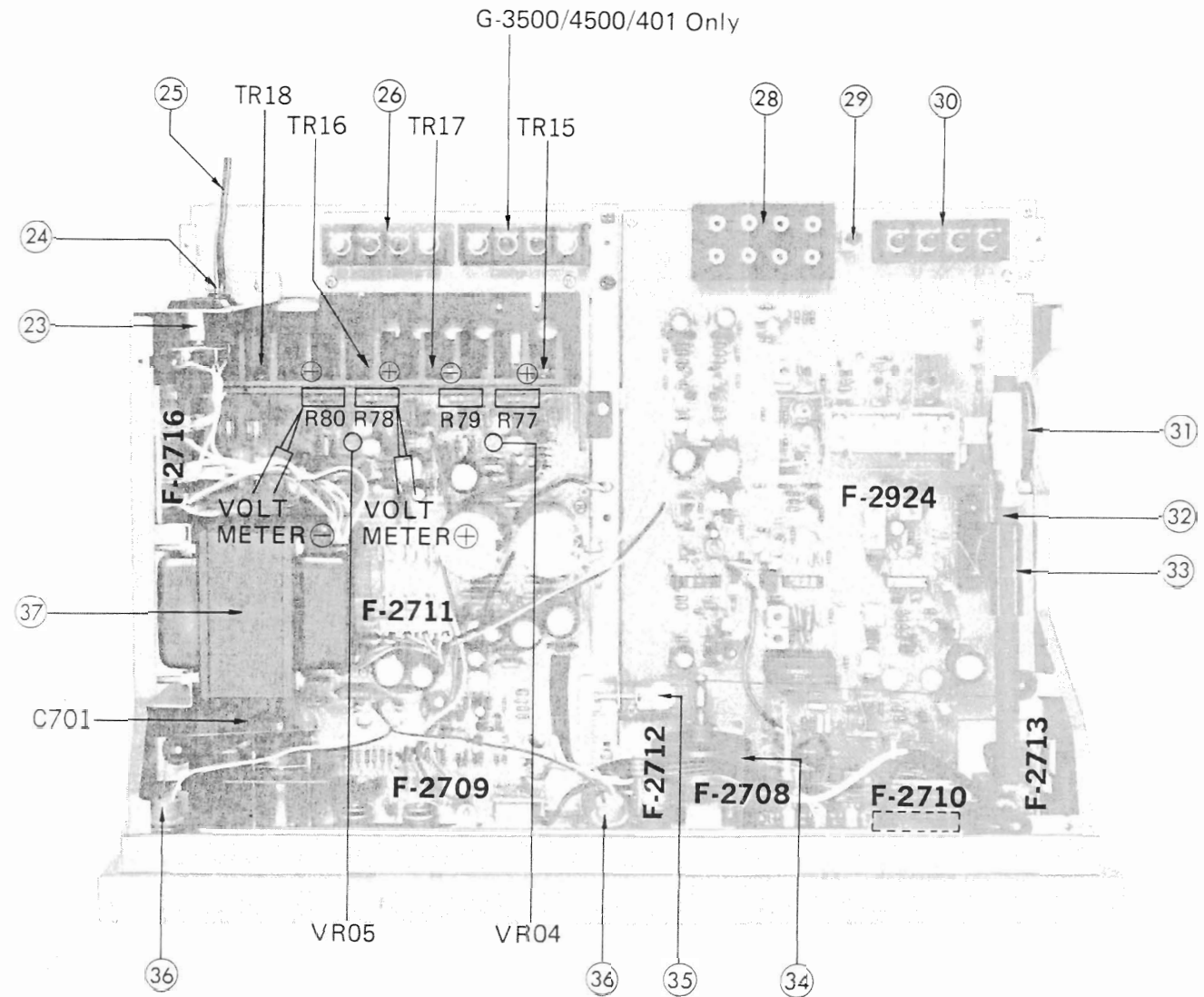

Parts List (Front & Top View)

Parts No.	Stock No.	Description	Parts No.	Stock No.	Description
1	5727150	Wood Bonnet		5408562	Dial Scale (G-3500)
	5236690	W.B. Type Bushing		5408502	Dial Scale (G-301)
	7007631	Front Panel Ass'y (G-3500/4500)	19	5408572	Dial Scale (G-4500)
2	7008001	Front Panel Ass'y (G-301)		5408512	Dial Scale (G-401)
	7008011	Front Panel Ass'y (G-401)		5305720	Backside Panel for dial scale
3	5305690	Inside Panel	20	7116032	Dial Pointer Ass'y
4	5426410	Power Illuminator Bar	21	4301120, 1	Tuning Meter
	2430320	Headphone Jack Socket (G-3500/4500/401)	22	4301110, 1	Signal Meter
5	2430340	Headphone Jack Socket (G-301)	23	2450070	AC Outlet
	5319142	Power & Speakers Switch Knob	24	3910600	Strain Relief, power cord
	1190530	Power Rotary Switch (G-301)	25	3800470, 1	AC Cord
6	1101850	Power & Speaker Rotary Switch (G-3500/4500/401)	26	2210340	4P Speaker Terminal
	5236470	M9 x 7, spacer nut	28	2200410, 1	8P Input Terminal
7	5319133	BASS Volume Knob	29	2230180	Ground Terminal
	1015300, 1	100kΩ x 2 Bass Volume	30	2210330	4P Antenna Terminal
	5319133	Treble Volume Knob	31	6146670	D-44 Type Pulley
8	1015300, 1	100kΩ x 2 Treble Volume	32	4200750	Bar Antenna
	5318981	Volume Knob	33	5289171	Bar Antenna Holder
9	1011130, 1	250kΩ (B) x 2 Volume	34	7036590	Tuning Unit
	5319133	Balance Volume Knob	35	7136101	Tension Unit
10	1005350, 1	250kΩ (B) Balance Volume	36	0400650	Pilot Lamp Ass'y
	5326690	Loudness Switch Knob		4002880	Power Transformer (G-3500)
11	1131490, 1	Loudness Switch	37	4002884	Power Transformer (G-301)
	5318972	Tuning Knob		4002870	Power Transformer (G-4500)
12	5326690	Knob, tape monitor switch		4002874	Power Transformer (G-401)
13	1131060, 1	Tape Monitor Switch	TR15, 16	0306541, 2	2SC1986 (Q, Y) } Transistor
	5319142	Selector Switch Knob	TR17, 18	0300911, 2	2SA771 (Q, Y) }
	1101840	Selector Switch		5288721	Plate for TR
14	5236470	M9 x 7, spacer nut		06598C1	0.01μF 150V C.C. XX, UL
	5058793	Bottom Plate	C 701	05981C7	0.01μF 250V M.C. EU, BS
15	5517250	Leg		0659811	0.01μF 125V C.C. CS
16	2430370	Microphone Jack Socket			
17	5319133	Microphone Mixing Volume Knob			
	1005340, 1	20kΩ (A) Mic Mixing Volume			
	0319060	L.E.D., FM Stereo Indicator			
18	5289180	L.E.D. Holder			
	5136030	Plastic Rivet			

G-3500/301  
G-4500/401

G-3500/301  
G-4500/401

• Design and specifications subject to change without notice for improvement.  
• La présentation et les spécifications sont susceptibles d'être modifiées sans préavis par suites d'améliorations éventuelles.  
• Änderungen, die dem technischen Fortschritt dienen, bleiben vorbehalten.

# 7. SCHEMATIC DIAGRAM 7-1. G-3500/301

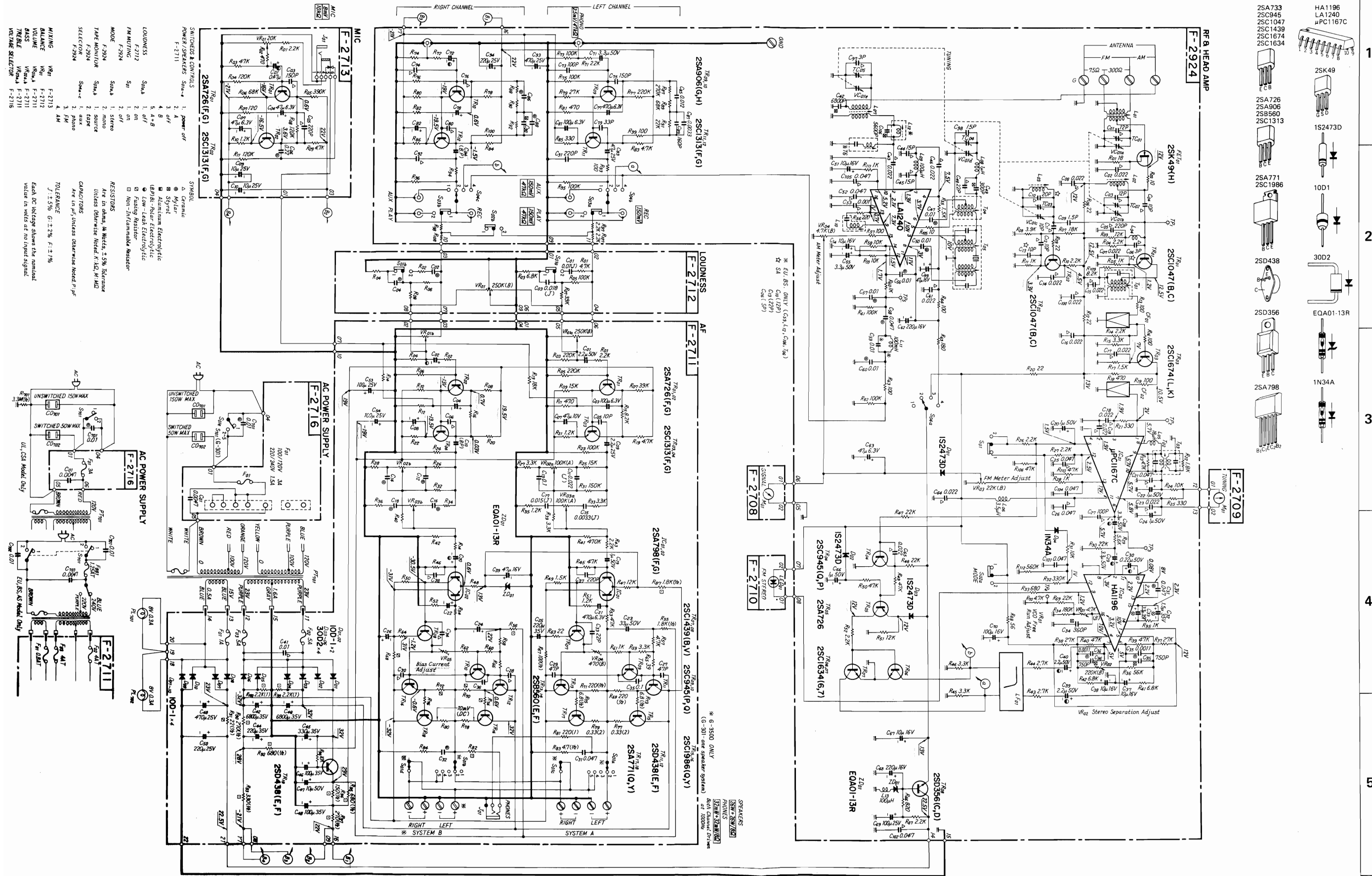

- 1 HA1196  
LA1240  
µPC1167C
- 2 2SK49
- 3 1S2473D
- 4 10D1
- 5 30D2
- EQA01-13R
- 1N34A
- 2SA726  
2SA906  
2SB560  
2SC1313
- 2SA771  
2SC1986
- 2SD438
- 2SD356
- 2SA798

- LOADNESS F-2712
- FM MUTING F-2924
- MODE F-2924
- TUNE MONITOR F-2924
- SELECTION F-2924
- MIXING F-2713
- MAINLINE F-2713
- VOLUME F-2713
- BASS F-2713
- TREBLE F-2713
- VOLUME SELECTOR F-2713

- 1. POWER OFF
- 2. A
- 3. B
- 4. C
- 5. A+B
- 1. ON
- 2. OFF
- 1. STEREO
- 2. MONO
- 1. SOURCE
- 2. DEEP
- 1. aux
- 2. PHONO
- 3. FM
- 4. AM

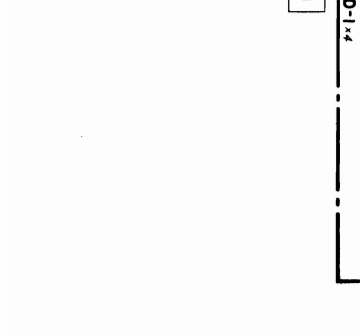
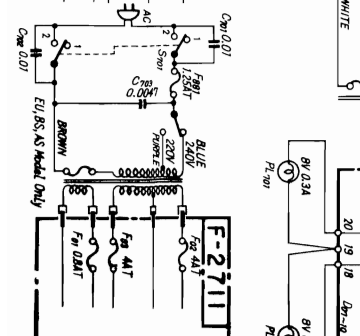
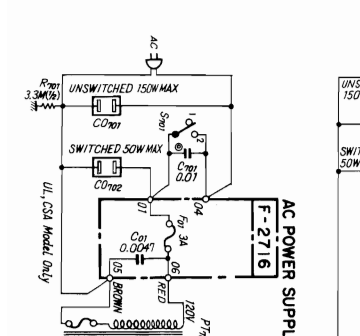

7-2. G-4500/401

- SWITCHES & CONTROLS**
- POWER/SPEAKERS: 1. power off, 2, 3, 4, 5, 6, 7, 8, 9, 10, 11, 12, 13, 14, 15, 16, 17, 18, 19, 20, 21, 22, 23, 24, 25, 26, 27, 28, 29, 30, 31, 32, 33, 34, 35, 36, 37, 38, 39, 40, 41, 42, 43, 44, 45, 46, 47, 48, 49, 50, 51, 52, 53, 54, 55, 56, 57, 58, 59, 60, 61, 62, 63, 64, 65, 66, 67, 68, 69, 70, 71, 72, 73, 74, 75, 76, 77, 78, 79, 80, 81, 82, 83, 84, 85, 86, 87, 88, 89, 90, 91, 92, 93, 94, 95, 96, 97, 98, 99, 100.

- SYMBOLS**
- o Ceramic
  - o Mylar
  - o Aluminum Electrolytic
  - (BP) Bi-polar Electrolytic
  - o Low-leak Electrolytic
  - o Fusing Resistor
  - o Non-Flammable Resistor
- RESISTORS**
- Are in ohms, M = MILLS, % = % tolerance
  - Unless otherwise noted, K, Ω, M, W, W, W
- CAPACITORS**
- Are in pF, unless otherwise noted, P = PPF
- TOLERANCE**
- J = ±5%, G = ±2%, F = ±1%
- FEED DC Voltage shows the nominal value in volts at no input signal.**

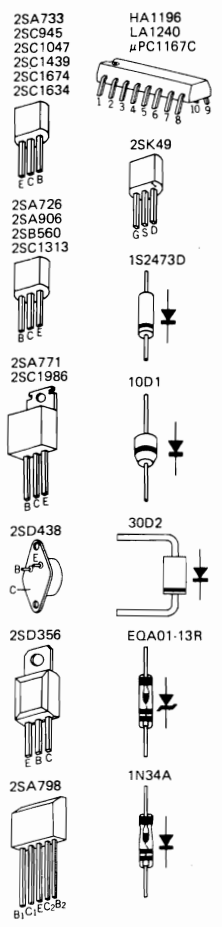
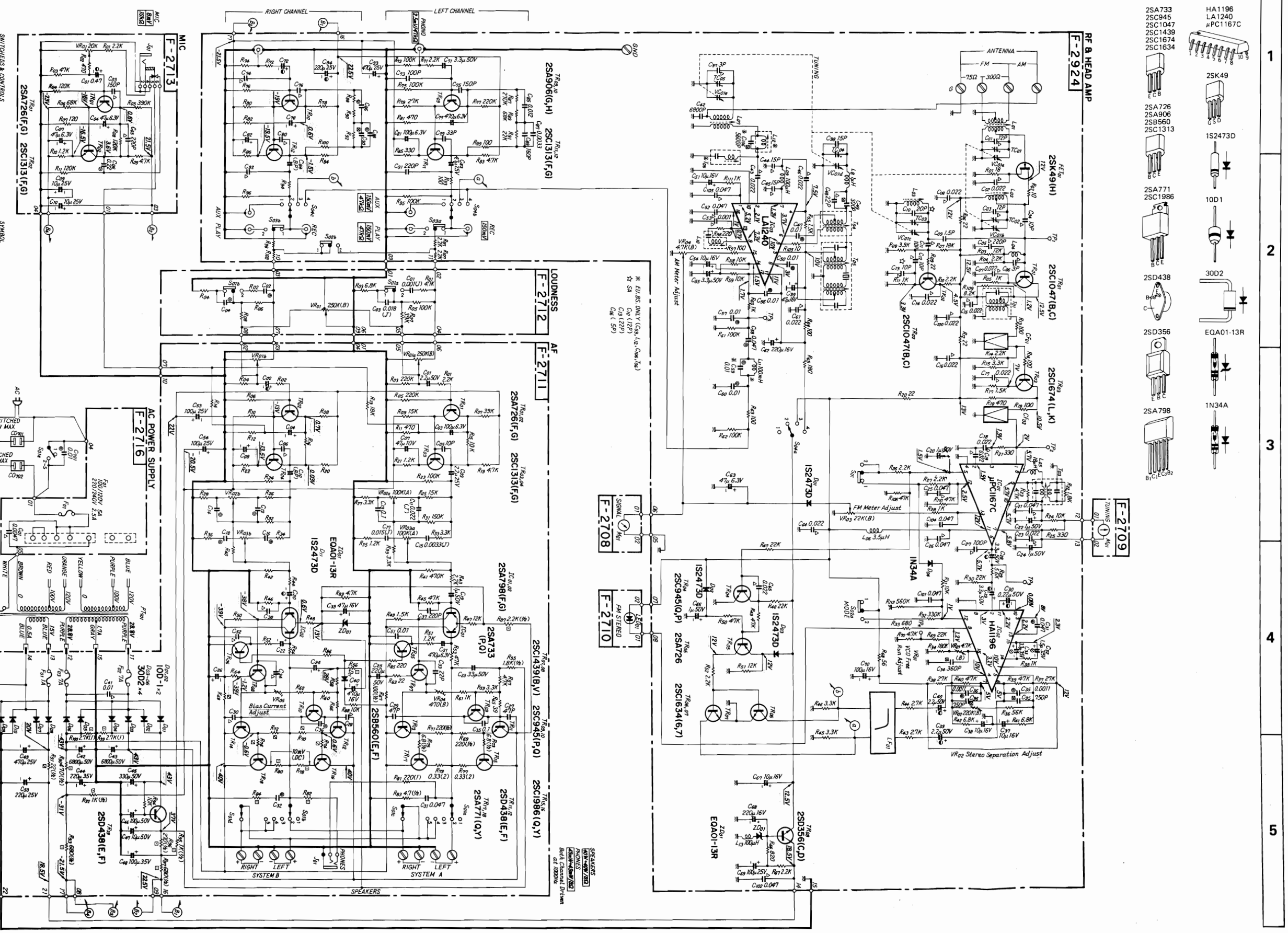

1  
2  
3  
4  
5



## 8. THREADING OF DIAL CORD

- \* If a dial cord is cut off or slips, replace it by following procedures.  
As this unit uses 0.5 mmφ cord, please replace it with the same type certainly.
- \* The length of dial cord is approximately 160 cm (65.3 inch).

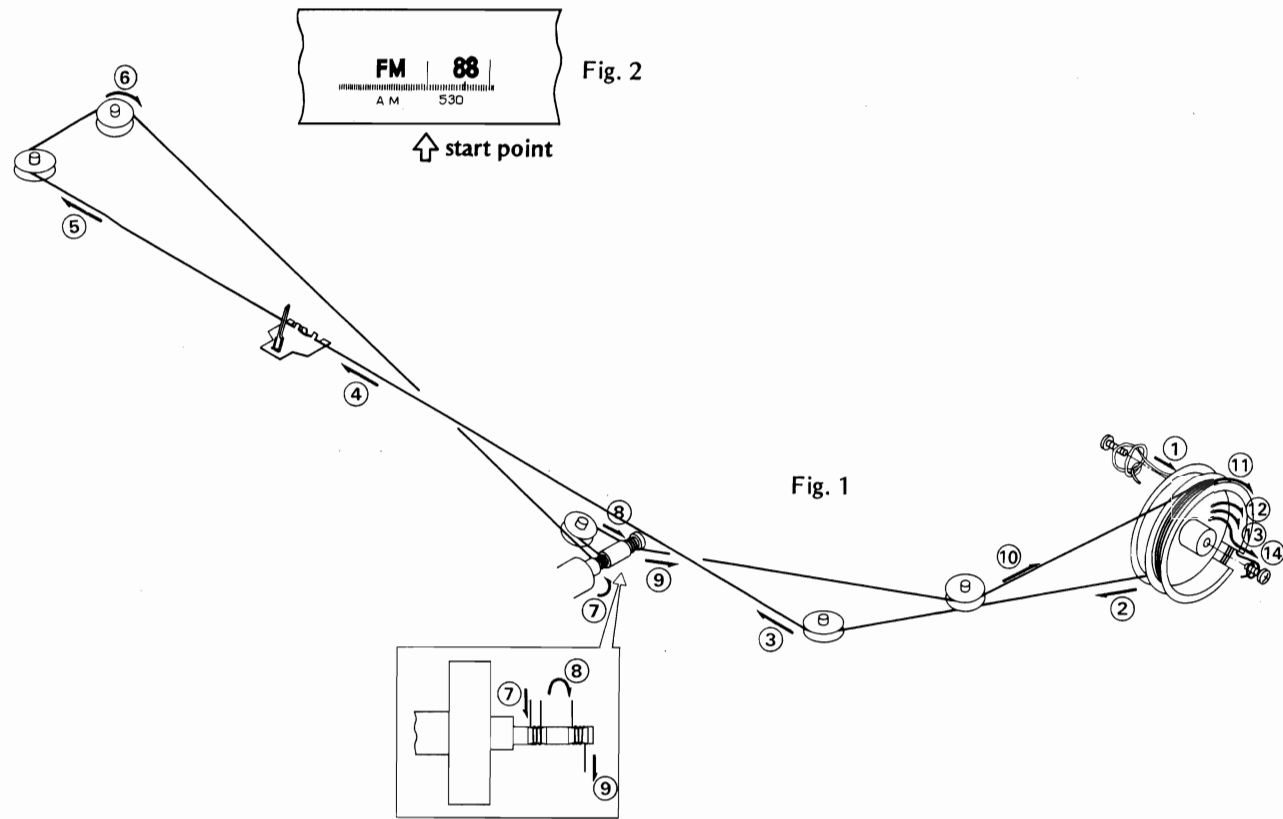

### 8-1. Threading of Dial Cord

Thread the dial cord in numerical order from 1 to 14 as Fig. 1.

- \* Close the variable capacitor completely (Maximum Capacitance).

Stock No.	Description
6036050	Dial Cord (0.5 mmφ)
6146670	Dial Pulley

### 8-2. Attachment of Dial Pointer

- 1) Close the variable capacitor completely.
- 2) Set the dial pointer to start point on dial scale as Fig. 2.

- \* Confirm that the dial pointer runs smoothly on the dial scale by turning the turning shaft.

## 9. PACKING LIST

Parts No.	Stock No.	Description
	9116143	Vinyl Cover
	9028090	Styrofoam Packing
	9001600	Carton Case (G-3500)
	9001410	Carton Case (G-301)
	9001490	Carton Case (G-4500)
	9001400	Carton Case (G-401)
	5996080	Curf Stopper

## 10. ACCESSORY PARTS LIST

Stock No.	Description
9204330	Operating Instructions (G-3500/4500)
9204290	Operating Instructions (G-301)
9204280	Operating Instructions (G-401)
9237860	Schematic Diagram (G-3500/301)
9237950	Schematic Diagram (G-4500/401)
3820100	FM Antenna

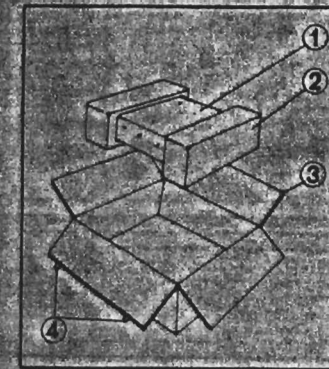

MEMO