

# SERVICE MANUAL

PURE POWER DC STEREO RECEIVER

## SANSUI G-8000/801 G-9000/901



**Sansui**

SANSUI ELECTRIC CO., LTD.

### SPECIFICATIONS

#### ◀G-8000/801▶

##### Audio section

###### Power output

Min. RMS, both channels driven, from 20 to 20,000 Hz with no more than 0.03% total harmonic distortion.

120 watts per channel into 8 ohms

120 watts per channel into 4 ohms

Load impedance . . . . . 4 and 8 ohms

###### Total harmonic distortion

less than 0.03% at or below rated min. RMS power output

Intermodulation distortion (70 Hz : 7 kHz = 4:1 SMPTE method) . . . . . less than 0.03% at rated power output

###### Frequency response (at 1 watt)

Overall (from AUX) . . . 5 to 50,000 Hz, +0.2 dB,

-1.5 dB

POWER AMP IN . . . DC to 200 kHz, +0 dB, -3.0 dB

RIAA curve deviation (PHONO, 20 Hz to 20 kHz)

+0.2 dB, -0.2 dB

Damping factor (20 Hz to 20 kHz, both channels driven)

60 into 8 ohms

###### Input sensitivity and impedance (at 1 kHz)

PHONO-1, 2 . . . . . 2.5 mV/47 kilohms

(Max. input capability: 240 mV at 1 kHz, less than

0.03% total harmonic distortion.)

MIC . . . . . 6 mV/10 kilohms

TAPE-1, 2 PLAY, AUX

150 mV/47 kilohms

###### Output level (at 1 kHz)

TAPE-1, 2 REC (pin jacks)

150 mV

TAPE-2 REC/PLAY (DIN socket)

43 mV

PRE AMP OUT . . . . . 1.0 V

###### Hum and noise (short-circuit, A-network)

PHONO-1, 2 . . . . . 78 dB

TAPE-1, 2 PLAY, AUX

95 dB

###### Channel separation (at 1 kHz)

PHONO-1, 2 . . . . . 60 dB

TAPE-1, 2 PLAY, AUX

70 dB

###### Controls

BASS . . . . . ±10 dB at 50 Hz

MIDRANGE . . . . . ±5 dB at 1.5 kHz

TREBLE . . . . . ±10 dB at 10 kHz

SUBSONIC FILTER . . . -3 dB at 16 Hz (6 dB/oct)

HIGH FILTER . . . . . -3 dB at 3 kHz (6 dB/oct)

LOUDNESS (VOLUME control: -30 dB position)

8 dB at 50 Hz

6 dB at 10 kHz

AUDIO MUTING . . . -20 dB

##### FM section

Tuning range . . . . . 88 to 108 MHz

###### Usable sensitivity

Mono IHF . . . . . 9.3 dBf (1.6 μV)

DIN . . . . . 1.0 μV

Stereo IHF . . . . . 15.5 dBf

###### 50 dB quieting sensitivity

Mono . . . . . 13.0 dBf

Stereo . . . . . 35.0 dBf

###### Signal to noise ratio (at 65 dBf)

Mono . . . . . 79 dB

Stereo . . . . . 75 dB

###### Distortion (at 65 dBf)

Mono . . . . . less than 0.07% at 100 Hz

less than 0.07% at 1,000 Hz

less than 0.1% at 6,000 Hz

Stereo . . . . . less than 0.12% at 100 Hz

less than 0.05% at 1,000 Hz

less than 0.1% at 6,000 Hz

###### Alternate channel selectivity (at 400 kHz)

80 dB

Capture ratio . . . . . 1.0 dB

Image response ratio . . . 95 dB

Spurious response ratio . . 95 dB

IF response ratio . . . . . 100 dB

Stereo separation . . . . . 40 dB at 100 Hz

45 dB at 1,000 Hz

35 dB at 10,000 Hz

30 dB from 30 to 15,000 Hz

Frequency response . . . . 30 to 15,000 Hz

+0.2 dB, -1.0 dB

###### Hum and noise (at 65 dBf)

75 dB

###### Antenna input impedance

300 ohms balanced

75 ohms unbalanced

To be continued

«G-8000/801»

AM section

Tuning range . . . . . 530 to 1,600 kHz  
Usable sensitivity (bar antenna)  
. . . . . 50 dB/m (300 μV/m)  
Selectivity (±10 kHz) . . . . . 30 dB  
Signal to noise ratio . . . . . 50 dB  
Distortion (at 30% Modulation, 80 dB/m)  
. . . . . less than 0.5%

Others

Power requirements

Power voltage . . . . . 100, 120, 220, 240 V  
(50/60 Hz)

Power consumption  
Rated consumption. 560 watts 630 VA  
Dimensions . . . . . 560 mm (22-1/16") W  
201 mm (7-15/16") H  
475 mm (18-3/8") D  
Weight . . . . . 24.6 kg (54.2 lbs) net  
27.4 kg (60.4 lbs) packed

\* Design and specifications subject to change without notice for improvements.

«G-9000/901»

Audio section

Power output

Min. RMS, both channels driven, from 20 to 20,000 Hz with no more than 0.03% total harmonic distortion.  
160 watts per channel into 8 ohms  
160 watts per channel into 4 ohms

Load impedance . . . . . 4 and 8 ohms

Total harmonic distortion

. . . . . less than 0.03% at or below rated min. RMS power output

Intermodulation distortion (70 Hz : 7 kHz = 4:1 SMPTE method) . . . . . less than 0.03% at rated power output

Frequency response (at 1 watt)

Overall (from AUX) . . . 5 to 50,000 Hz, +0.2 dB, -1.5 dB

POWER AMP IN . . . . . DC to 200 kHz, +0 dB, -3.0 dB

RIAA curve deviation (PHONO, 20 Hz to 20 kHz)

. . . . . +0.2 dB, -0.2 dB

Damping factor (20 Hz to 20 kHz, both channels driven)

. . . . . 60 into 8 ohms

Input sensitivity and impedance (at 1 kHz)

PHONO-1, 2 . . . . . 2.5 mV/47 kilohms  
(Max. input capability: 330 mV at 1 kHz, less than 0.03% total harmonic distortion.)

MIC . . . . . 6 mV/10 kilohms

TAPE-1, 2 PLAY, AUX . . . . . 150 mV/47 kilohms

Output level (at 1 kHz)

TAPE-1, 2 REC (pin jacks) . . . . . 150 mV

TAPE-2 REC/PLAY (DIN socket) . . . . . 43 mV

PRE AMP OUT . . . . . 1.0 V

Hum and noise (short-circuit, A-network)

PHONO-1, 2 . . . . . 78 dB

TAPE-1, 2 PLAY, AUX . . . . . 95 dB

Channel separation (at 1 kHz)

PHONO-1, 2 . . . . . 60 dB

TAPE-1, 2 PLAY, AUX . . . . . 70 dB

Controls

BASS . . . . . ±10 dB at 50 Hz (BASS TURNOVER at 400 Hz)

Tone selector . . . . . 200, 400 Hz

MIDRANGE . . . . . ±5 dB at 1.5 kHz

TREBLE . . . . . ±10 dB at 10 kHz (TREBLE TURNOVER at 1.5 kHz)

Tone selector . . . . . 1.5, 3 kHz

SUBSONIC FILTER . . . . . -3 dB at 16 Hz (6 dB/oct)

HIGH FILTER . . . . . -3 dB at 3 kHz (6 dB/oct)

LOUDNESS (VOLUME control: -30 dB position)

. . . . . 8 dB at 50 Hz

. . . . . 6 dB at 10 kHz

AUDIO MUTING . . . . . -20 dB

FM section

Tuning range . . . . . 88 to 108 MHz

Usable sensitivity

Mono IHF . . . . . 8.7 dBf (1.5 μV)

DIN . . . . . 0.9 μV

Stereo IHF . . . . . 15.0 dBf

50 dB quieting sensitivity

Mono . . . . . 12.5 dBf

Stereo . . . . . 34.0 dBf

Signal to noise ratio (at 65 dBf)

Mono . . . . . 80 dB

Stereo . . . . . 76 dB

Distortion (at 65 dBf)

Mono . . . . . less than 0.06% at 100 Hz

. . . . . less than 0.06% at 1,000 Hz

. . . . . less than 0.08% at 6,000 Hz

Stereo . . . . . less than 0.1% at 100 Hz

. . . . . less than 0.08% at 1,000 Hz

. . . . . less than 0.1% at 6,000 Hz

Alternate channel selectivity (at 400 kHz)

WIDE . . . . . 55 dB

NARROW . . . . . 90 dB

Capture ratio . . . . . 0.9 dB

Image response ratio . . . . . 110 dB

Spurious response ratio . . . . . 110 dB

IF response ratio . . . . . 110 dB

Stereo separation . . . . . 40 dB at 100 Hz

. . . . . 50 dB at 1,000 Hz

. . . . . 40 dB at 10,000 Hz

. . . . . 30 dB from 30 to 15,000 Hz

Frequency response . . . . . 30 to 15,000 Hz

. . . . . +0.2 dB, -1.0 dB

Hum and noise (at 65 dBf)

. . . . . 76 dB

Antenna input impedance

. . . . . 300 ohms balanced

. . . . . 75 ohms unbalanced

AM section

Tuning range . . . . . 530 to 1,600 kHz

Usable sensitivity (bar antenna)

. . . . . 50 dB/m (300 μV/m)

Selectivity (±10 kHz) . . . . . 30 dB

Signal to noise ratio . . . . . 50 dB

Distortion (at 30% Modulation, 80 dB/m)

. . . . . less than 0.45%

Image response ratio . . . . . 70 dB at 1,000 kHz

IF response ratio . . . . . 70 dB at 1,000 kHz

Others

Power requirements

Power voltage . . . . . 100, 120, 220, 240 V  
(50/60 Hz)

Power consumption

Rated consumption. 680 watts 880 VA

Dimensions . . . . . 560 mm (22-1/16") W

. . . . . 201 mm (7-15/16") H

. . . . . 495 mm (19-1/2") D

Weight . . . . . 26.9 kg (59.3 lbs) net

. . . . . 29.7 kg (65.5 lbs) packed

Design and specifications subject to change without notice for improvements.

1. BLOCK DIAGRAM

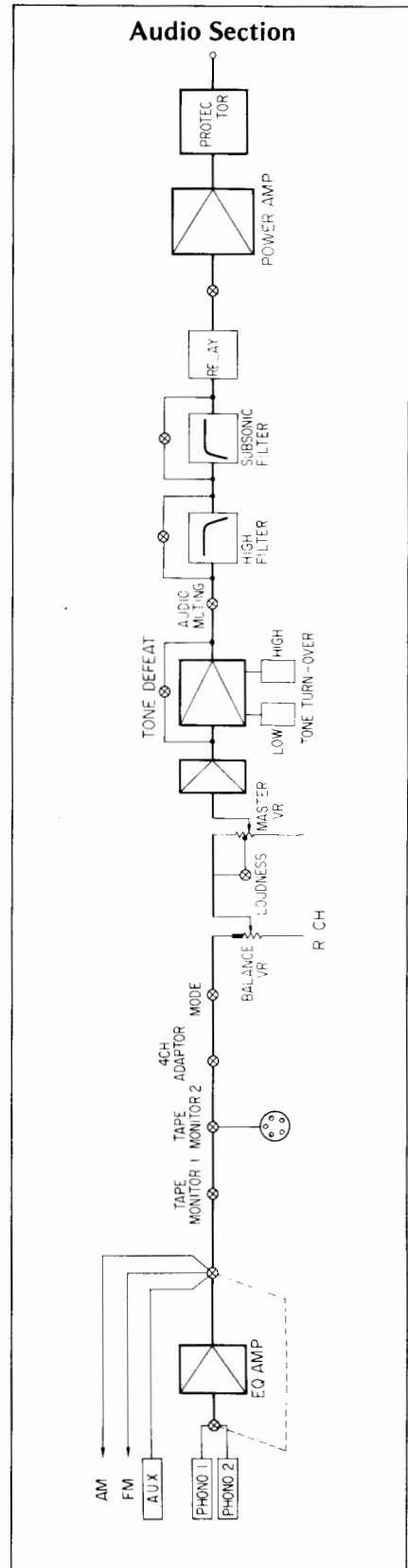

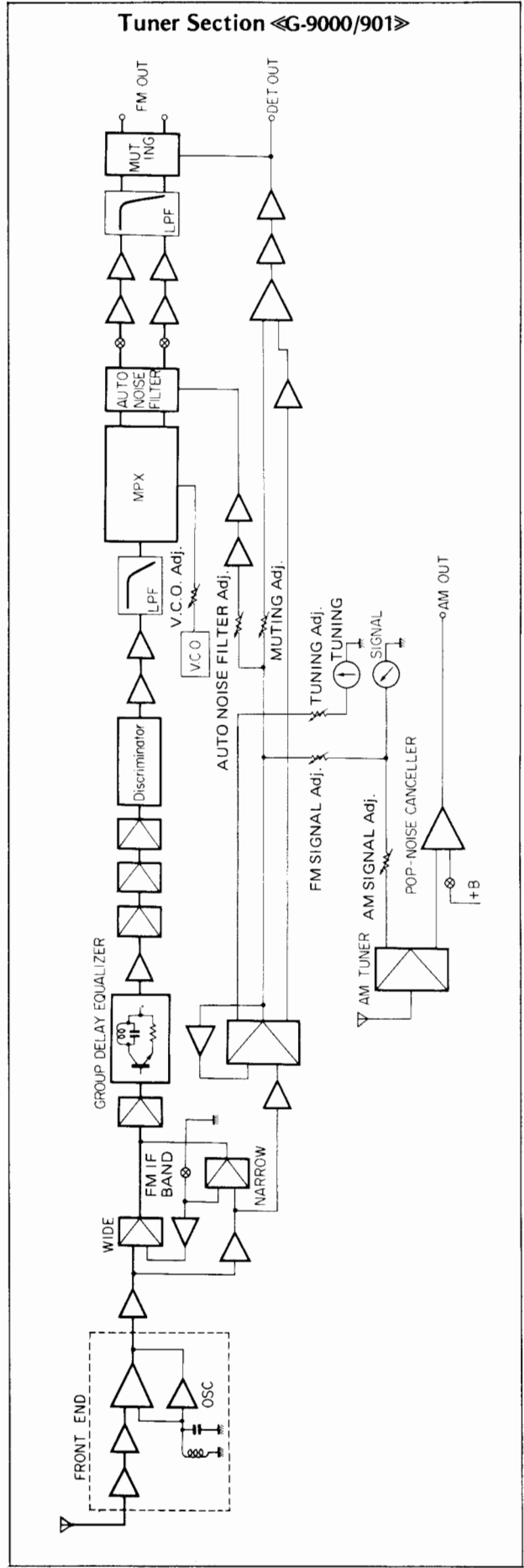
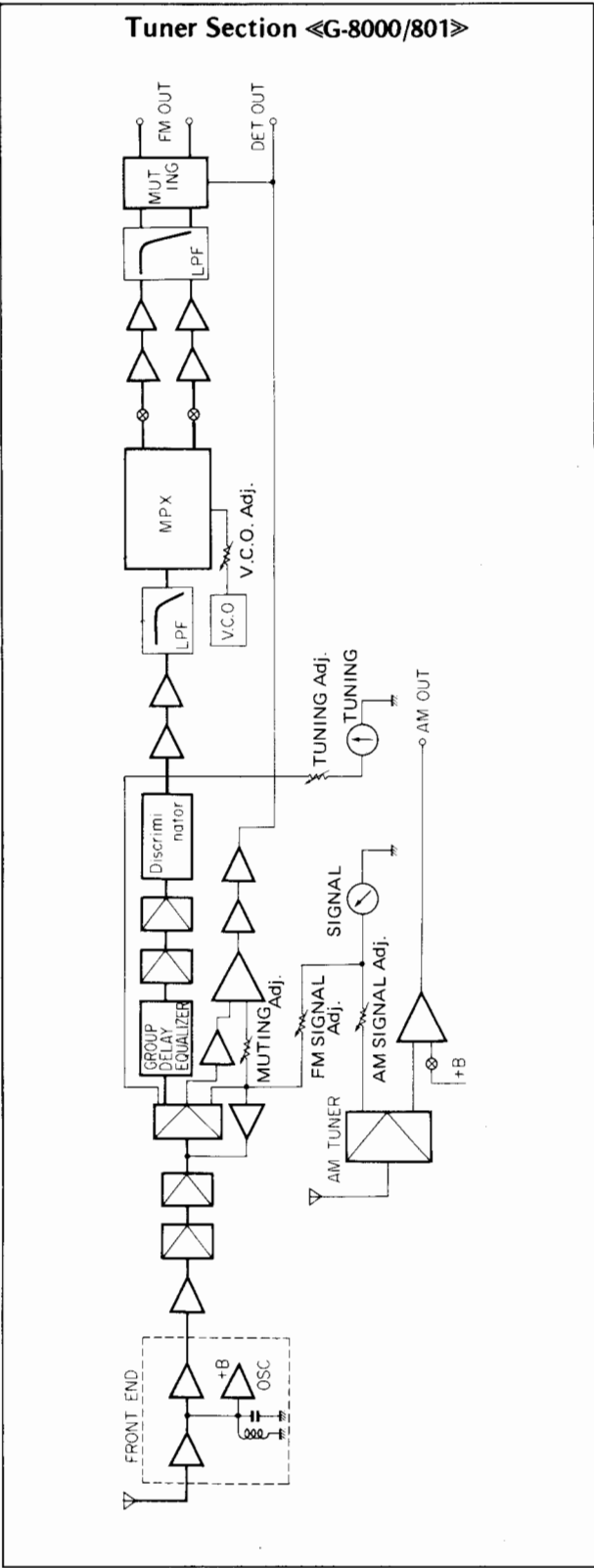

## 2. ADVANTAGES

### 1. FM AUTO NOISE FILTER

This circuit is provided the function of high-cut filter to ordinary high-blend function and also is operated by monaural signal in proportion to the electric field intensity. As proportional signal to input is supplied to TR26, this transistor controls the current flowing to TR27 and photo-coupler. (Fig. 2-3)

The characteristic of photo-coupler is that the resistance of Cd cell is changed by the current flowing to photo-diode in Photo-coupler as shown in Fig. 2-1.

High-blend amount is determined by the time constant defined by this change of Cd cell resistance value, C103, and C104. (Fig. 2-3)

In high electric field intensity, the current flowing to photo coupler becomes low that Cds cell indicates high resistance value not to perform the high-blend function.

In low electric field intensity, the current flowing photo coupler becomes increased that Cd cell indicates low resistance value, therefore, the blend amount at high frequency range is increased and S/N ratio is improved.

The relations of input electric field intensity, the current flowing photo-coupler, and separation are indicated in Fig. 2-2.

Zener diode and varistor connected to emitter of TR27 determine the working range of this circuit, and VR13 is for adjusting the working point.

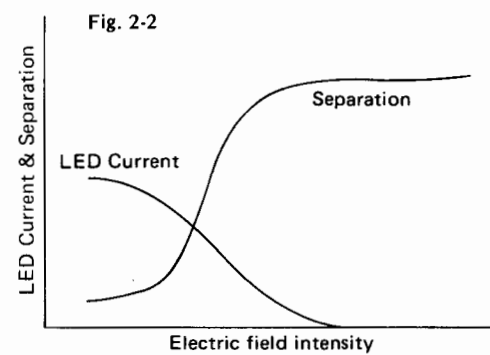
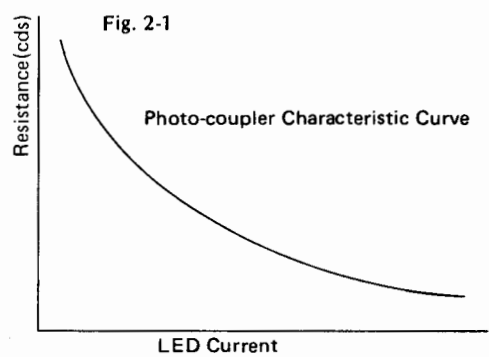
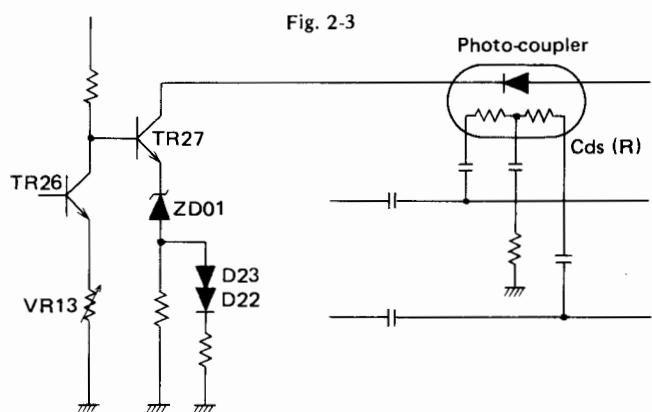

### 2. Group Delay Equalizer

In the IF amplification stage of model G-9000, group delay equalizer and ceramic filter of distinguished characteristics are employed for the purpose of obtaining excellent-group delay characteristic.

Generally, characteristics of both selectivity and group delay are inversely related and hard to be compatible.

The group delay equalizer (Sansui patent) used in G-9000 is provided to improve the group delay characteristic without sacrificing the selectivity in spite of its characteristic being inversely related to group delay characteristic of ceramic filter as shown in Fig. 2-4. Consequently, group delay characteristic is improved without changing selectivity characteristic after compounded both characteristic.

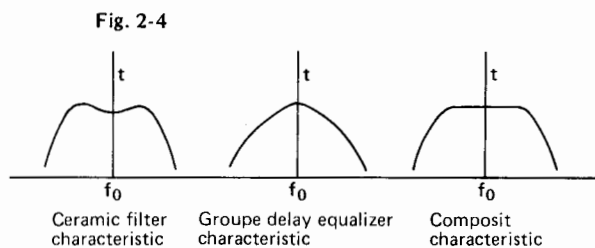

### 3. METER A.G.C. CIRCUIT

The meter A.G.C. circuit provided with G-8000/G-9000 is installed for the purpose of the obtaining linear scale signal meter indication. The operation of this circuit is;

1. The IF input signal is supplied to pin 1 of IC (HA1137W), then, the proportional signal to the IF input for the signal meter is outputed from pin 13. (Fig. 2-6)
2. This outputed signal is not only making the signal meter function but also becoming the control signal of A.G.C. circuit consisting of TR06 and D11.
3. Since the bias is not applied to TR06 by the function of D11 when IF input level is low, the internal impedance of TR06 is high that the A.G.C. is OFF state. The leading edge characteristic is shown in Fig. 2-5.
4. When the input signal over the certain level is applied to TR06, the impedance of TR06 decreases proportionally to the input signal and changes amount of the input signal by-passing.
5. By the reason above, the voltage appears at pin 13 of IC varies as the Fig. 2-5, indicated just on the right side.

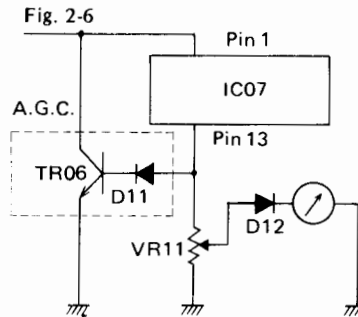
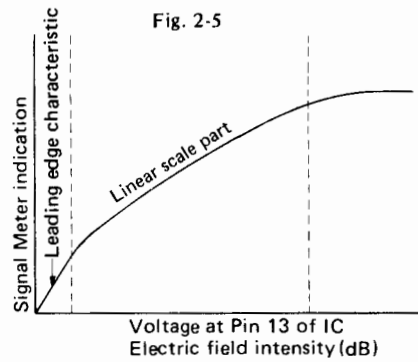

## 3. ADJUSTMENTS

### 1. Tuner Section

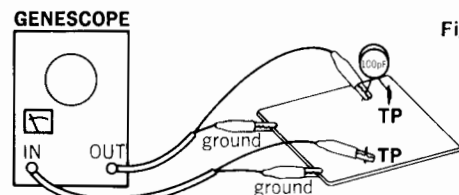

Fig. 3-1

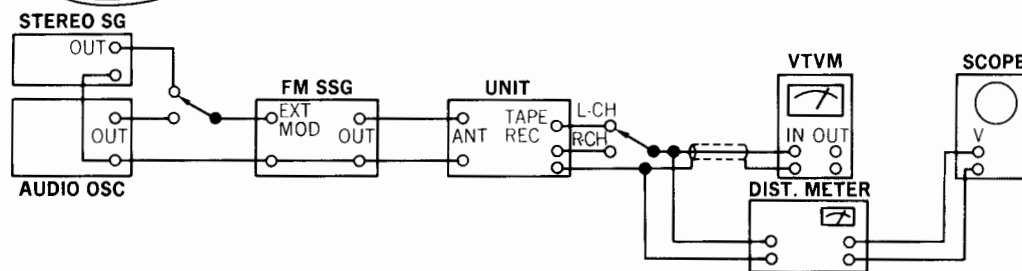
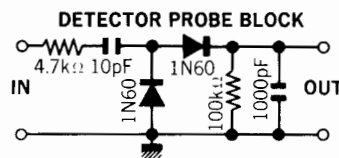
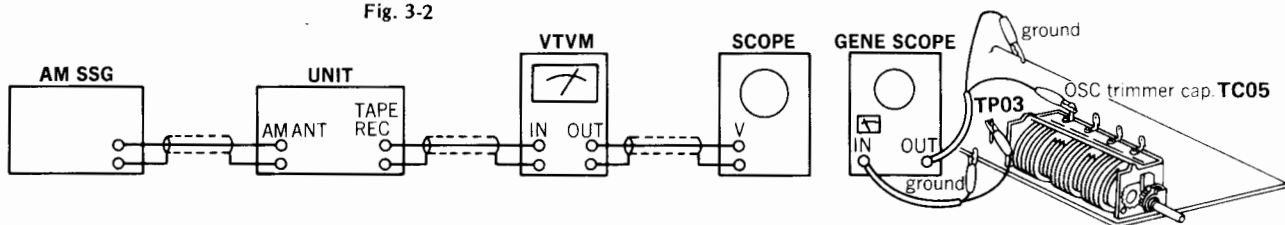

Fig. 3-2



(A) Tune Section «G-8000/801»

(1) FM IF, RF Adjustment and Dial Calibration (See Fig. 3-1 on Page 4 & Fig. 3-3 on Page 8)

Note: 1. SELECTOR . . . FM AUTO

2. MPX NOISE CANCELLER . . . . . OFF



3. DOLBY DE-EMPH . . . . . OFF

• Dolby is a trademark of Dolby Laboratories, Inc.

4. MODE . . . . . MONO

5. FM MUTING . . . . . OFF

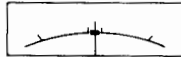
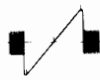
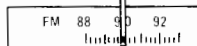
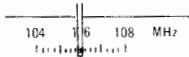
6. Connection . . . Connect the output of genescopes to TP through 100 pF ceramic capacitor.

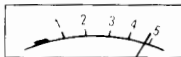
STEP	SUBJECT	FEED SIGNAL		MEASURE OUTPUT	ADJUST	ADJUST FOR	REMARKS
		FROM	TO				
1.	Tuning Meter IF Coil	98 MHz ANT Input 10 dBf (4.8 dB) 1000 Hz (100% MOD) FM SSG	ANT terminal 300Ω	REC OUT L or R-CH VTVM & Scope	Tune Dial	Make symmetrical Sine Curve	
		98 MHz ANT Input 15 dBf (9.8 dB) 1000 Hz (100% MOD) FM SSG	Same as above	Tuning Meter	T01 F-2919 (F-2715)	Center on Tuning Meter	
			Same as above	Signal Meter	T01 Front end	Max.	
		98 MHz ANT Input 65 dBf (59.8 dB) 1000 Hz (100% MOD) FM SSG	Same as above	Between Connector Pin 11, 12 (Use Volt Meter)	T04 F-2919 (F-2715)	0V	
2.	Discriminator Coil In case of using Genescopes	Output 98 dB Genescopes	VC03 Front end	Connector Pin 11, 12 F-2919 (F-2715) Genescopes	T03 F-2919 (F-2715)	Steep linearity of S curve	
	Discriminator Coil, Groupe Delay Equaliz- er Coil In case of using Dist Meter	98 MHz ANT Input 65 dBf (59.8 dB) 1000 Hz (100% MOD) FM SSG	ANT terminal 300Ω	REC OUT L or R-CH Dist Meter	T02, 03, VR06 F-2919 (F-2715)	Min. T.H.D.	
3.	90 MHz Dial Calibration	90 MHz ANT Input 65 dBf (59.8 dB) 1000 Hz (100% MOD) FM SSG	Same as above	REC OUT L or R-CH VTVM & Scope	L05 Front end	Max. Indication on signal meter & VTVM & Scope Center Indication on Tuning Meter	
	106 MHz Dial Calibration	106 MHz ANT Input 65 dBf (59.8 dB) 1000 Hz (100% MOD) FM SSG	Same as above	Same as above	TC04 Front end		
4.	90 MHz RF Adj.	90 MHz ANT Input Minimum Value with sine wave 1000 Hz (100% MOD) FM SSG	Same as above	Same as above	L01, L02 L03 Front end	Same as above	
	106 MHz RF Adj.	106 MHz ANT Input Minimum Value with sine wave 1000 Hz (100% MOD) FM SSG	Same as above	Same as above	TC01, TC02, TC03 Front end	Same as above	
5.	Signal Meter Volume	98 MHz ANT Input 85 dBf (79.8 dB) 1000 Hz (100% MOD) FM SSG	Same as above	Signal Meter	VR01 F-2919 (F-2715)	4.8 on Meter	

(2) FM STEREO Adjustment (See Fig. 3-1 on Page 4 & Fig. 3-3 on Page 8)

Note: 1. MODE . . . . . STEREO



STEP	SUBJECT	FEED SIGNAL		MEASURE OUTPUT	ADJUST	ADJUST FOR	REMARKS
		FROM	TO				
1.	PLL VCO Adj.	98 MHz ANT Input 65 dBf (59.8 dB) FM SSG Pilot 19 kHz (9% MOD) SUB 1 kHz + Pilot (100% MOD) STEREO SG	ANT terminal 300Ω	Stereo indicator	VR04 F-2919 (F-2715)	Light indicator	Adjust the VR04 within center of lighting level.

To be continued

	PLL VCO Adj. In case of using Freq. counter.	98 MHz ANT Input 65 dBf (59.8 dB) FM SSG (no MOD)	Same as above	TP01 F-2919 (F-2715) Use Freq. counter	VR04 F-2919 (F-2715)	19 kHz $\pm$ 30 Hz F-2919 76 kHz $\pm$ 100 Hz (F-2715)	
2.	(19 kHz B.P.F. Adj.)	98 MHz ANT Input 65 dBf (59.8 dB) FM SSG Pilot 19 kHz (9% MOD) L Mode 100 Hz + Pilot (100% MOD) STEREO SG	Same as above	REC OUT L-CH VTVM & Scope	T05 F-2715	Max.	
	(19 kHz B.P.F. Adj.) In case of using Dist. Meter	98 MHz ANT Input 65 dBf (59.8 dB) FM SSG Pilot 19 kHz (9% MOD) SUB 100 Hz + Pilot (100% MOD) STEREO SG	Same as above	REC OUT L-CH Use Dist. Meter	T05 F-2715	Min. T.H.D.	
3.	Separation	98 MHz ANT Input 65 dBf (59.8 dB) FM SSG Pilot 19 kHz (9% MOD) R Mode 1 kHz + Pilot (100% MOD) STEREO SG	Same as above	REC OUT L-CH VTVM & Scope	VR05 F-2919 (F-2715)	-40 dB	Confirm separation L-CH $\rightarrow$ R-CH
4.	Muting level & indicator level	98 MHz ANT Input 17 dBf (11.8 dB) FM SSG Pilot 19 kHz (9% MOD) SUB 1 kHz + Pilot (100% MOD) STEREO SG	Same as above	Stereo indicator REC OUT L or R-CH VTVM & Scope	VR02 F-2919 (F-2715)	Muting level 17 dBf (11.8 dB) Indicator lighting level 17 dBf (11.8 dB)	FM MUTING Switch ON

**(3) FM IF Adjustment & Dial Calibration (See Fig. 3-2 on Page 4 & Fig. 3-3 on Page 8)**

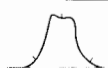
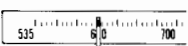

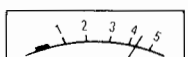

Note: 1. Selector . . . . . AM

STEP	SUBJECT	FEED SIGNAL		MEASURE OUTPUT	ADJUST	ADJUST FOR	REMARKS
		FROM	TO				
1.	IF Coil	Genescope Output 70 dB	TC05 Front end	TP03 F-2919 (F-2715)	CF31, T32 F-2919 (F-2715)	Max. IF waveform	
2.	600 kHz Dial Calibration	600 kHz ANT Input 60 dB 400 Hz (MOD 30%) AM SSG	AM ANT terminal	REC OUT L or R-CH VTVM & Scope	L33 F-2919 (F-2715)	Max. Indication on Signal Meter & V.T.V.M.	
	1400 kHz Dial Calibration	1400 kHz AN Input 60 dB 400 Hz (MOD 30%) AM SSG	Same as above	Same as above	TC05 Front end		
3.	600 kHz RF Adj.	600 kHz ANT Input 50 dB 400 Hz (MOD 30%) AM SSG	Same as above	Same as above	Bar Antenna	Same as above	
	1400 kHz RF Adj.	1400 kHz ANT Input 50 dB 400 Hz (MOD 30%) AM SSG	Same as above	Same as above	TC06, Front end	Same as above	
4.	Signal Meter volume	1000 kHz ANT Input 80 dB 400 Hz (MOD 30%) AM SSG	Same as above	Signal Meter	VR31 F-2919 (F-2715)	4.3 on meter	
5.	460 kHz Trap	460 kHz ANT Input 80 dB 400 Hz (MOD 30%) AM SSG	Same as above	REC OUT L or R-CH VTVM & Scope	L31, T31 F-2919 (F-2715)	Min. Output	

**(B) Tuner Section «G-9000/901»**

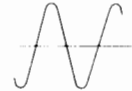
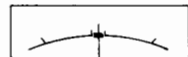
**(1) FM IF, RF Adjustment and Dial Calibration (See Fig. 3-1 on Page 4 & Fig. 3-4 on Page 8)**

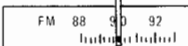
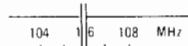
- Note: 1. SELECTOR . . . FM AUTO  
 2. FM AUTO NOISE FIL . . . . . OFF  
 3. DOLBY DE-EMPH . . . . . OFF  
 4. MODE . . . . . MONO  
 5. MUTING . . . . . OFF  
 6. FM IF BAND . . . . . WIDE  
 7. Connection . . . Connect the output of genescope to TP through 100 pF ceramic capacitor.

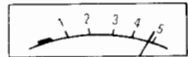
STEP	SUBJECT	FEED SIGNAL		MEASURE OUTPUT	ADJUST	ADJUST FOR	REMARKS
		FROM	TO				
1.	Tuning Meter IF Coil	98 MHz ANT Input 10 dBf (4.8 dB) 1000 Hz (100% MOD) FM SSG	ANT terminal 300Ω	REC OUT L or R-CH VTVM & Scope	Tune Dial	Make symmetrical Sin Curve	
		98 MHz ANT Input 15 dBf (9.8 dB) 1000 Hz (100% MOD) FM SSG	Same as above	Tuning Meter	T05 F-2920 (F-2719)	Center on Tuning Meter	
			Same as above	Signal Meter	T04 F-2920 (F-2719) IFT01 Front end	Max.	
		98 MHz ANT Input 65 dBf (59.8 dB) 1000 Hz (100% MOD) FM SSG	Same as above	Between Connector Pin 15, 16 F-2920 (F-2719)	T03 F-2920 (F-2719)	0V	(Use Volt Meter)
2.	Discriminator Coil In case of using Genescope	Output 90 dB Genescope	VC03 Front end	Between Connector Pin 15, 16 F-2920 (F-2719) Genescope	T02 F-2920 (F-2719)	Steep linearity of S curve	
	Discriminator Coil In case of using Dist Meter	98 MHz ANT Input 65 dBf (59.8 dB) 1000 Hz (100% MOD) FM SSG	ANT terminal 300Ω	REC OUT L or R-CH Dist Meter	T01, T02 F-2920 (F-2719)	Min. T.H.D.	
3.	90 MHz Dial Calibration	90 MHz ANT Input 65 dBf (59.8 dB) 1000 Hz (100% MOD) FM SSG	Same as above	REC OUT L or R-CH VTVM & Scope	Dial pointer	Max. Indication on signal meter & VTVM & Scope Center Indication on Tuning Meter	
	106 MHz Dial Calibration	106 MHz ANT Input 65 dBf (59.8 dB) 1000 Hz (100% MOD) FM SSG	Same as above	Same as above	TC05 Front end		
4.	90 MHz RF Adj.	90 MHz ANT Input Minimum Value with sine wave 1000 Hz (100% MOD) FM SSG	Same as above	Same as above	T02, T03 T04 Front end	Same as above	
	106 MHz RF Adj.	106 MHz ANT Input Minimum Value with sine wave 1000 Hz (100% MOD) FM SSG	Same as above	Same as above	TC01, TC02 TC03, TC04 Front end	Same as above	
5.	Signal Meter Volume	98 MHz ANT Input 85 dBf (79.8 dB) 1000 Hz (100% MOD) FM SSG	Same as above	Signal Meter	VR11 F-2920 (F-2719)	4.8 on Meter	

**(2) FM STEREO Adjustment (See Fig. 3-1 on Page 4 Fig. 3-4 on Page 8)**

- Note: 1. MODE . . . . . STEREO



STEP	SUBJECT	FEED SIGNAL		MEASURE OUTPUT	ADJUST	ADJUST FOR	REMARKS
		FROM	TO				
1.	PLL VCO Adj.	98 MHz ANT Input 65 dBf (59.8 dB) FM SSG Pilot 19 kHz (9% MOD) SUB 1 kHz + Pilot (100% MOD) STEREO SG	ANT terminal 300Ω	Stereo indicator	VR01 F-2920 (F-2715)	Light indicator	Adjust the VR01 within center of lighting level.



	PLL VCO Adj. In case of using Freq. counter.	98 MHz ANT Input 65 dBf (59.8 dB) FM SSG (no MOD)	Same as above	TP29 F-2920 (F-2719) Use Freq. counter	VR01 F-2920 (F-2719)	19 kHz $\pm$ 30 Hz F-2920 76 kHz $\pm$ 100 Hz (F-2719)	
2.	(19 kHz B.P.F. Adj.)	98 MHz ANT Input 65 dBf (59.8 dB) FM SSG Pilot 19 kHz (9% MOD) L Mode 100 Hz + Pilot (100% MOD) STEREO SG	Same as above	REC OUT L-CH VTVM & Scope	T06 F-2920 (F-2719)	Max.	
	(19 kHz B.P.F. Adj.) In case of using Dist. Meter	98 MHz ANT Input 65 dBf (59.8 dB) FM SSG Pilot 19 kHz (9% MOD) SUB 100 Hz + Pilot (100% MOD) STEREO SG	Same as above	REC OUT L-CH Use Dist Meter	T06 F-2920 (F-2719)	Min. T.H.D.	
3.	Separation	98 MHz ANT Input 65 dBf (59.8 dB) FM SSG Pilot 19 kHz (9% MOD) R Mode 1 kHz + Pilot (100% MOD) STEREO SG	Same as above	REC OUT L-CH VTVM & Scope	VR02 F-2920 (F-2719)	-45 dB	Confirm separation L-CH $\rightarrow$ R-CH
4.	Muting level & indicator level	98 MHz ANT Input 17 dBf (11.8 dB) FM SSG Pilot 19 kHz (9% MOD) SUB 1 kHz - Pilot (100% MOD) STEREO SG	Same as above	Stereo indicator	VR12 F-2920 (F-2719)	Muting level 17 dBf (11.8 dB) Indicator lighting level 17 dBf (11.8 dB)	FM MUTING Switch ON
5.	Auto Noise Filter Adj.	98 MHz ANT Input 45 dBf (39.8 dB) 10 kHz (100% MOD) FM SSG	Same as above	REC OUT L or R-CH VTVM & Scope	VR13 F-2920 (F-2719)	OUT -3 dB Standard (Auto Noise Filter OFF)	Auto Noise Filter Switch ON

(3) FM IF Adjustment & Dial Calibration (See Fig. 3-2 on Page 4 & Fig. 3-4 on Page 8)

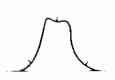
Note: 1. Selector . . . . . AM

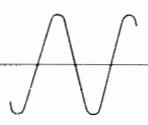
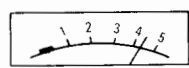
STEP	SUBJECT	FEED SIGNAL		MEASURE OUTPUT	ADJUST	ADJUST FOR	REMARKS
		FROM	TO				
1.	IF Coil	Genescope Output 70 dB	TC07 Front end	TP06 F-2920 (F-2719)	CF51, T56 F-2920 (F-2719)	Max. IF waveform	
2.	600 kHz Dial Calibration	600 kHz ANT Input 60 dB 400 Hz (MOD 30%) AM SSG	AM ANT terminal	REC OUT L or R-CH VTVM & Scope	L54 F-2920 (F-2719)	Max. Indication on Signal Meter & V.T.V.M.	
	1400 kHz Dial Calibration	1400 kHz AN Input 60 dB 400 Hz (MOD 30%) AM SSG	Same as above	Same as above	TC07 Front end		
3.	600 kHz RF Adj.	600 kHz ANT Input 50 dB 400 Hz (MOD 30%) AM SSG	Same as above	Same as above	Bar Antenna L55 F-2920 (F-2719)	Same as above	
	1400 kHz RF Adj.	1400 kHz ANT Input 50 dB 400 Hz (MOD 30%) AM SSG	Same as above	Same as above	TC06, TC08 Front end	Same as above	
4.	Signal Meter volume	1000 kHz ANT Input 80 dB 400 Hz (MOD 30%) AM SSG	Same as above	Signal Meter	VR52 F-2920 (F-2719)	4.3 on meter	
5.	460 kHz Trap	460 kHz ANT Input 80 dB 400 Hz (MOD 30%) AM SSG	Same as above	REC OUT L or R-CH VTVM & Scope	L53, L56 T51 F-2920 (F-2719)	Min. Output	

«G-8000/801»

Fig. 3-3

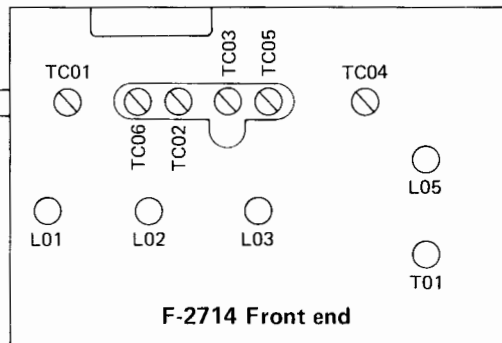
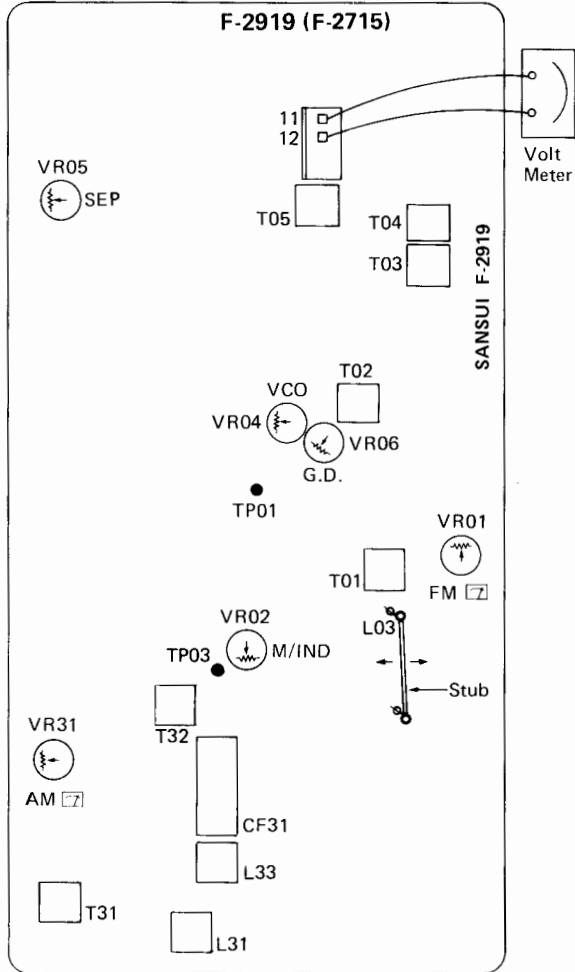

«G-9000/901»

Fig. 3-4

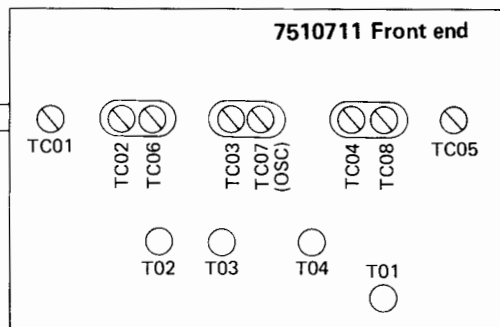
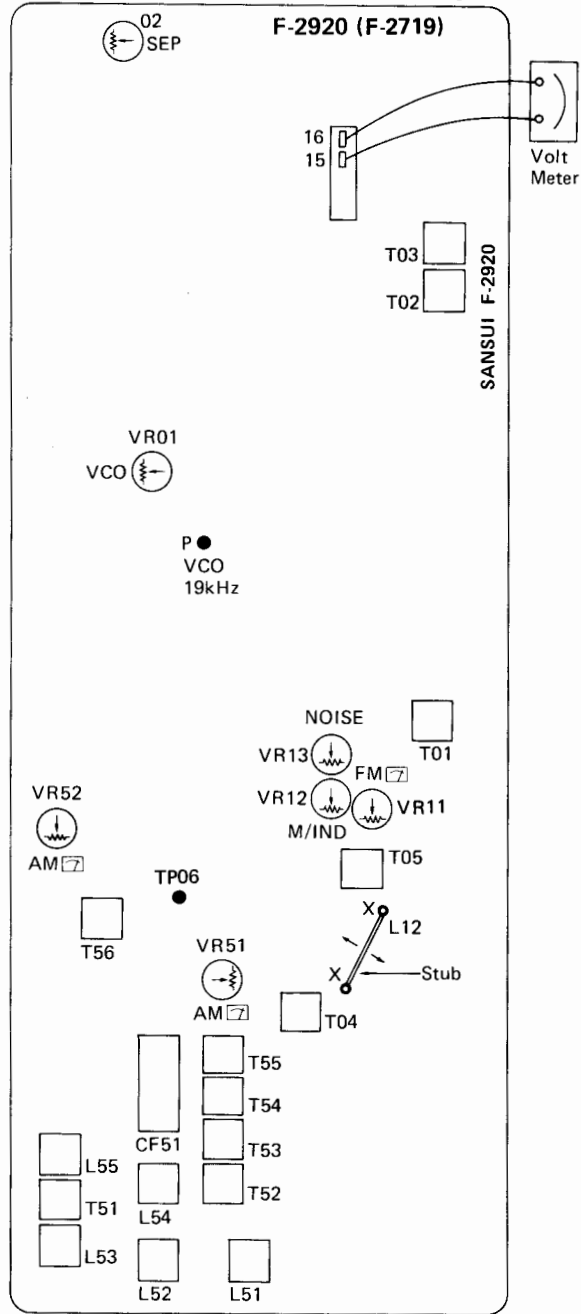

Note: 1. Tuner circuit board F-2919 is employed in «G-8000/801» and F-2920 in «G-9000/901», however some of F-2715 for «G-8000/801» and F-2719 for «G-9000/901» are commonly used.

2. To set the Tuning meter indication to center on meter without input signal on FM adjustment, move the Stub to vary the coupling coefficient of induction between L12 and the stub.

● **NEW MEASUREMENT FOR FM.**

Input signal level under the provision of IHFM-T-200, a new measurement method is indicated by available power ratio "dBf". To obtain approximate available power ratio "dBf", abstract 0.8 from attenuator indication of general FMSSG (open load indication type); however, the former measurement, IHFM-T-100 is designated together too.

The way of modulation on IHFM-T-200 is shown below.

	modulation frequency	modulation mode	modulation factor
FM MONO	1000Hz		100%
FM STEREO	1000Hz	SUB	Pilot 9% Pilot + SUB 100%

※The relation between the standard input 65dBf of IHFM-T-200 and the former indication "dB" is shown below.

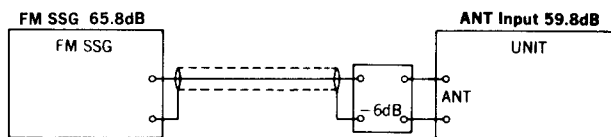

● **Abbreviations**

**Equipment**

AM FM Generator Oscilloscope	Genescope
AM Standard Signal Generator	AM SSG
FM Standard Signal Generator	FM SSG
FM Stereo Generator	Stereo SG
Oscilloscope	Scope
Audio Oscillator	Audio Osc.
Distortion Meter	Dist. Meter

**Others**

Clockwise	CW.
Counterclockwise	CCW.
Antenna	ANT.
Modulation	MOD.
Total Harmonic Distortion	T.H.D.

**2. Audio Section**

**(A) Driver Circuit Board Adjustment (See the picture of top view on page 17.)**

Note: 1. Master Volume . . . . . Minimum

2. For adjustment, run the unit for more than 3 minutes after the power is switched on.

STEP	SUBJECT	EQUIPMENT	MEASURE OUTPUT	ADJUST	ADJUST FOR	REMARKS
1.	DC 0V L-CH	DC Volt Meter	Speaker Terminal	VR01, VR02 F-2806	DC 0V ±5mV	<ul style="list-style-type: none"> <li>○ Set VR01 and VR02 to center position.</li> <li>○ Then, for the purpose of proceeding the accurate adjustment, set the voltage to 0 volt by VR01 first and VR02 next.</li> <li>○ By turning VR03 counterclockwise, the bias current is decreased gradually.</li> </ul>
2.	DC 0V R-CH	Same as above	Same as above	VR01, VR02 F-2806	DC 0V ±5mV	
3.	Bias Current L-CH	Same as above	TP Terminal (+) (-)	VR03 F-2806	DC 16mV ±1mV	
4.	Bias Current R-CH	Same as above	TP Terminal (+) (-)	VR03 F-2806	DC 16mV ±1mV	

**(B) Power Meter Adjustments (See the picture of bottom view on page 18.)**

Note: 1. Master Volume . . . . . Maximum

2. For this adjustment, run the unit for more than 2 minutes after turning on the power switch.

AUDIO OSCILLATOR		OUTPUT TERMINAL	ADJUST	ADJUST FOR
OUTPUT	CONNECTING POINT			
At 1 kHz Sine wave, set the amplifier-output to 20V on both channels by adjusting O.S.C.-output level	Input terminal of Amplifier	Speaker terminal 8Ω VTVM Oscilloscope	VR01 (L-CH) VR02 (R-CH) on F-2809	Set the pointer of power meter to 50W on both channels

# 4. PARTS LOCATION & PARTS LIST

Since some of capacitors and resistors are omitted from parts lists in this Service Manual, refer to the Common Parts List for capacitors & resistors which was appended previously to each Sansui Manual.

## 1. F-2919 Tuner Circuit Board (Stock No. 7521841●G-8000/801)

Conductor Side

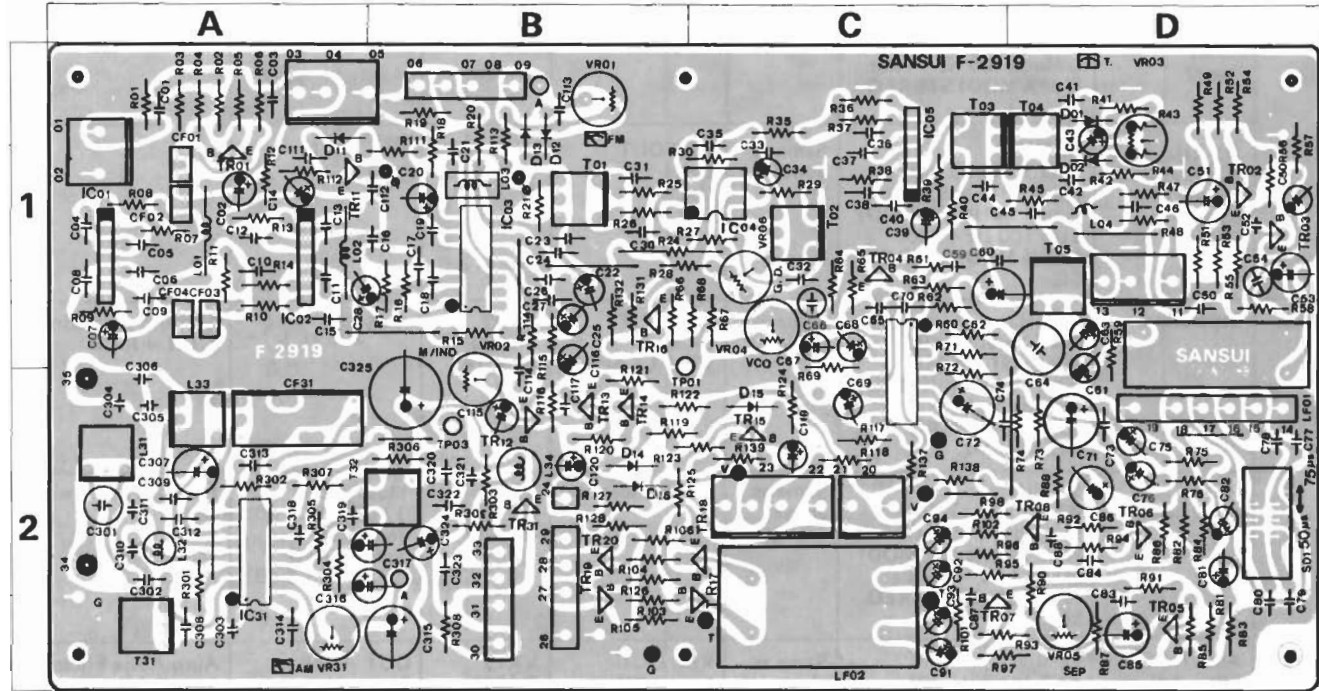

### Parts List

Parts No.	Stock No.	Description	Position	Parts No.	Stock No.	Description	Position	Parts No.	Stock No.	Description	Position
TR01	0306341, 2	2SC 1674 L, K	1A	IC 03	0360350	HA 1137W	1B	L 01	4290011	3.5 μH	1A
TR02	0300920, 1	2SA 726 (F), (G)	1D	IC 04	0360510	LA-122	1C	L 02	4290011	3.5 μH	1A
	0300930, 1	2SA 872 D, E		IC 05	0360540	μPC 1163H IC	1C	L 03	4290300	18 μH	1B
TR03	0306010, 1	2SC 1222 (2) U, E	1D	IC 06	0360700	μPC 1173C		L 04	4900110	100 μH	1D
	0306070, 1	2SC 1313 F, G		IC 31	0360390	HA 1197	2A	L 01	4900400	100 μH	
TR05	0300920, 1	2SA 726 (F), (G)	2D	D 01	0311160	1S 2473D	1D	L 31	4290250	21 μH Choke Coil	2A
	0300930, 1	2SA 872 D, E			0311180	1S 1588		L 32	4900110	100 μH Inductor	2A
TR06	0300920, 1	2SA 726 (F), (G)	2D	D 02	0311160	1S 2473D	1D	L 33	4220590	OSC Coil	2A
	0300930, 1	2SA 872 D, E			0311180	1S 1588		L 34	4900220	100 mH Inductor G 801 only	2B
TR07	0306010, 1	2SC 1222 (2) U, E	2C	D 11	0340120	VD1212	1A	T 01	4235860	FM IF Coil	1B
	0306070, 1	2SC 1313			0340150	MV 12		T 02	4235860	FM IF Coil	1B
TR08	0306010, 1	2SC 1222 (2) U, E	2D	D 12	0311160	1S 2473D	1B	T 03	4236010	FM IF Coil	1C
	0306070, 1	2SC 1313 F, G			0311180	1S 1588		T 04	4236020	FM IF Coil	1D
TR11	0306341, 2	2SC 1674 L, K	1A	D 13	0311160	1S 2473D	1B	T 31	4230620	IF Coil	2A
TR12	0305731 ~ 3	2SC 711 E, F, G	2B	D 14	0311180	1S 1588	1B	T 32	4230620	IF Coil	2B
	0305951 ~ 3	2SC945 Q, P, K			0311160	1S 2473D		CF01	0910420	Ceramic Filter	1A
TR13	0305731 ~ 3	2SC 711 E, F, G	2B	D 15	0311180	1S 1588	2B	CF02	0910420	Ceramic Filter	1A
	0305951 ~ 3	2SC 945 Q, P, K			0340120	VD1212		CF03	0910420	Ceramic Filter	1A
TR14	0305731 ~ 3	2SC 711 E, F, G	2B	D 16	0340150	MV 12	2C	CF04	0910420	Ceramic Filter	1A
	0305951 ~ 3	2SC 945 Q, P, K			0311160	1S 2473D		CF31	0910370	Ceramic Filter	2A
TR15	0300510 ~ 2	2SA 733 P, Q, R	2C	D 17	0311180	1S 1588	2B	LF01	0910400	Filter	2D
TR16	0300510 ~ 2	2SA 733 P, Q, R	1B	D 17	0311160	1S 2473D		LF02	0910360	Low Pass Filter	2C
TR17	0305731 ~ 3	2SC 711 E, F, G	2C	D 17	0311180	1S 1588		VR01	1035130	10 kΩ (B) Volume, FM signal	2C
	0305880 ~ 2	2SC 1634 (5), (6), (7)		LD01	0319060	SG2 12C (red) LED		VR02	1035190	100 kΩ (B) Volume, muting	2B
TR18	0305731 ~ 3	2SC 711 E, F, G	2C	C 54	0620391	390 pF 50V	1D	VR03	1035130	10 kΩ (B) Volume	
	0305880 ~ 2	2SC 1634 (5), (6), (7)		C 64	0629001	6800 pF 50V	1D	VR04	1034250	4.7 kΩ (B) Volume, V C O	1C
TR19	0305731 ~ 3	2SC 711 E, F, G	2B	C 66	0629005	360 pF 50V	1C	VR05	1034310	47 kΩ (B) Volume, SEP	2D
	0305880 ~ 2	2SC 1634 (5), (6), (7)		C 67	0573339	3.3 μF 35V	1C	VR31	1035070	1 kΩ (B) Volume, AM Signal	2A
TR20	0305731 ~ 3	2SC 711 E, F, G	2B	C 68	0573159	1.5 μF 35V	1C	S 01	1110240	Slide Switch, OE EMPHASIS	2A
	0305880 ~ 2	2SC 1634 (5), (6), (7)		C 69	0573228	0.22 μF 35V	2C		2410590	4P Pin Assy Type D	
TR31	0306580	2 2SC 1634 (5), (6), (7)	2B	C 301	0620562	5600 pF 50V P C	2A		2410910	2P Pin Assy Type E	
IC 01	0360590	TA 7302P	1A	C 304	0668400	15 pF 50V C C	2A				
IC 02	0360540	μPC 1163H	1A	C 306	0620331	330 pF 50V P C	2A				

## 2. F-2810 RF Power Supply Circuit Board (Stock No. 7502681●G-8000/801)

(Stock No. 7502651●G-9000/901)

Conductor Side

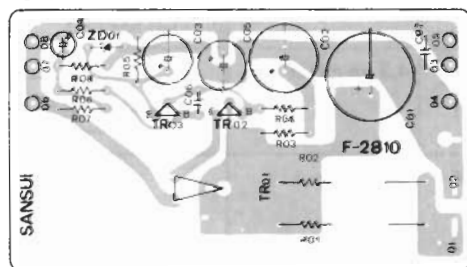

### Parts List

Parts No.	Stock No.	Description
TR01	0308551, 2	2SD315V10 D, E
TR02	0305951 ~ 3	2SC945 Q, P, K
TR03	0305951 ~ 3	2SC945 Q, P, K
ZD01	0316390	RD6.2E B Diode
R 01	0135151	150 Ω 5W
R 02	0135151	150 Ω 5W

3. F-2920 Tuner Circuit Board (Stock No. 7521831●G-9000/901)

Conductor Side

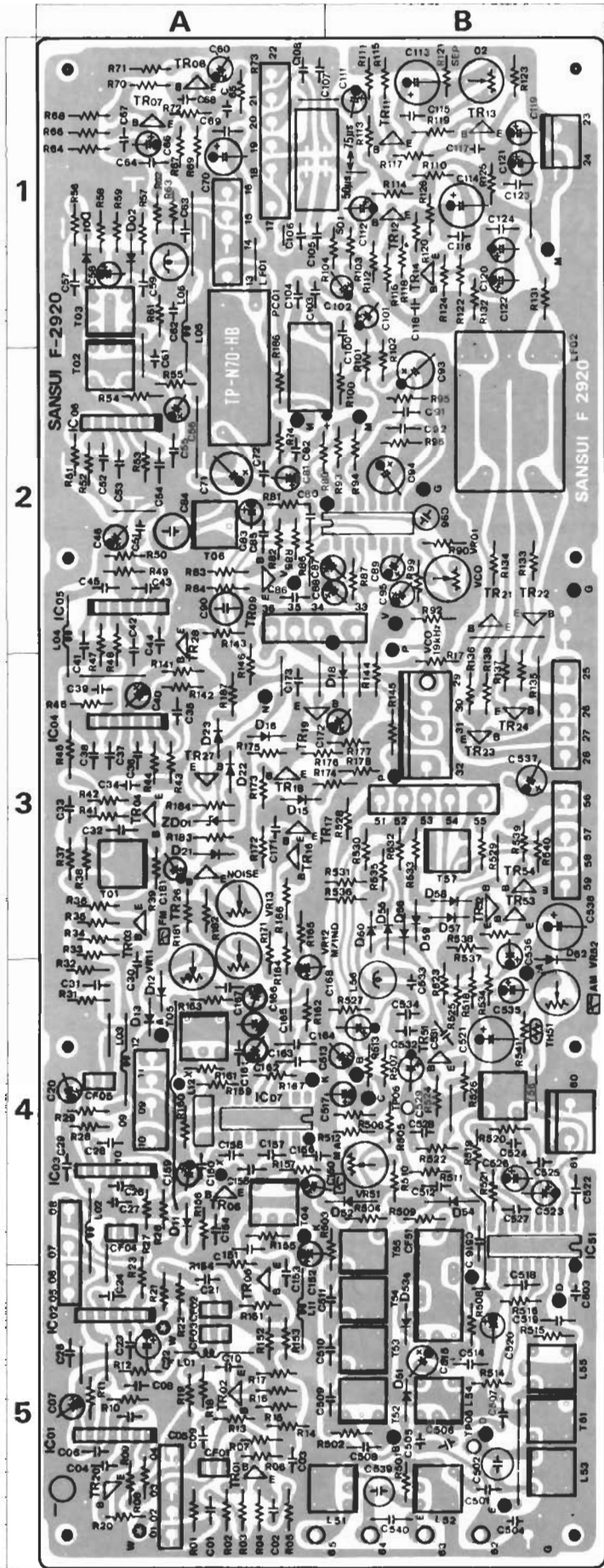

Parts List

Parts No.	Stock No.	Description	Position
TR01	0360340	~22SC 1674 M. L. K	5A
TR02	0360340	~22SC 1674 M. L. K	5A
TR03	0360340	~22SC 1674 M. L. K	3A
TR04	0360340	~22SC 1674 M. L. K	3A
TR05	0360340	~22SC 1674 M. L. K	5A
TR06	0360340	~22SC 1674 M. L. K	4A
TR07	0300920, 1	2SA 726 (F), (G)	1A
	0300930, 1	2SA 872 D, E	
	0306010, 1	2SC 1222 (2) U, E	
TR08	0306070, 1	2SC 1313 F, G	1A
	0300920, 1	2SA 726 (F), (G)	
TR11	0300930, 1	2SA 872 D, E	1B
	0300920, 1	2SA 726 (F), (G)	
TR12	0300930, 1	2SA 872 D, E	1B
	0306010, 1	2SC 1222 (2) U, E	
TR13	0306070, 1	2SC 1313 F, G	1B
	0306010, 1	2SC 1222 (2) U, E	
TR14	0306070, 1	2SC 1313 F, G	1B
	0305731	~325C 711 E, F, G	
TR16	0305951	~325C 945 Q, P, K	3A
	0305731	~325C 711 E, F, G	Transistor
TR17	0305951	~325C 945 Q, P, K	3A
	0305731	~325C 711 E, F, G	
TR18	0305951	~325C 945 Q, P, K	3A
	0305731	~325C 711 E, F, G	
TR19	030510	~22SA 733 P, Q, R	3A
	0305731	~325C 711 E, F, G	
TR20	0305951	~325C 945 Q, P, K	5A
	0305731	~325C 711 E, F, G	
TR21	0305731	~325C 711 E, F, G	2B
	0306580	~22SC 1634 (5), (6), (7)	
TR22	0305731	~325C 711 E, F, G	2B
	0306580	~22SC 1634 (5), (6), (7)	
TR23	0305731	~325C 711 E, F, G	3B
	0306580	~22SC 1634 (5), (6), (7)	
TR24	0305731	~325C 711 E, F, G	3B
	0306580	~22SC 1634 (5), (6), (7)	
TR26	0305731	~325C 711 E, F, G	3A
	0305951	~325C 945 Q, P, K	
TR27	0305731	~325C 711 E, F, G	3A
	0305951	~325C 934 Q, P, K	
TR28	030510	~22SA 733 P, Q, R	2A
TR54	0306580	~22SC 1634 (5), (6), (7)	3B
IC 01	0360590	TA 7302P	5A
IC 02	0360590	TA 7302P	5A
IC 03	0360590	TA 7302P	4A
IC 04	0360590	TA 7302P	3A
IC 05	0360270	μPC 577H	2A
IC 06	0360540	μPC 1163H	2A
IC 07	0360350	HA 1137W	4A
IC 08	0360700	μPC 1173C	
IC 51	0360390	HA 1197	4B
D 01	0311160	1S 2473D	1A
	0311180	1S 1588	
D 02	0311160	1S 2473D	Diode
	0311180	1S 1588	
D 11	0340120	VD1212	Varistor
	0340150	MV 12	
D 12	0311160	1S 2473D	Diode
	0311180	1S 1588	
D 15	0311160	1S 2473D	Diode
	0311180	1S 1588	
D 16	0340120	VD1212	Varistor
	0340150	MV 12	
D 18	0311160	1S 2473D	Diode
	0311180	1S 1588	
D 19	0311160	1S 2473D	Diode
	0311180	1S 1588	
D 21	0311160	1S 2473D	Diode
	0311180	1S 1588	
D 22	0340120	VD1212	Varistor
	0340150	MV 12	
D 23	0340120	VD1212	Varistor
	0340150	MV 12	
ZD01	0316390	RD6 2E B	3A
	0316400	RD6 2E C	
PC 01	0920080	PB73 G35-911 Composite part	1A
C 32	0669505	5 pF 50V C.C.	3A
C 65	0620301	390 pF 50V P.C.	1A
C 80	0601477	0.047 μF 50V M.C.	2A
C 87	0573109	1.0 μF 35V	2A
C 88	0573339	3.3 μF 35V	T.C.
C 89	0573228	0.22 μF 35V	2B
C 90	0629005	360 pF 50V P.C.	2A
C 96	0620511	510 pF P.C.	2B
C 504	0669395	10 pF 50V C.C.	5B
C 505	0620301	300 pF 50V P.C.	5B
L 01	4290011	3.5 μH	5A
L 02	4290011	3.5 μH	4A
L 03	4290011	3.5 μH Peaking Coil	4A
L 04	4290011	3.5 μH	2A
L 05	4290011	3.5 μH	1A
L 06	4900110	100 μH Inductor	1A
	4900400	100 μH	
L 11	4290011	3.5 μH Peaking Coil	5A
L 12	4290300	18 μH Inductor	4A
L 54	4220590	OSC Coil	5B
L 55	4210360	RF Coil	5B
L 56	4900220	100 mH Inductor G 901 only	4B
T 01	4236030	FM IF Coil	2A
T 02	4236010	FM IF Coil	3A
T 03	4236020	FM IF Coil	1A
T 04	4235930	FM IF Coil	4A
T 05	4235860	FM IF Coil	4A
T 56	4230620	IF Coil	4B
CF 51	0910370	Ceramic Filter	5B
LF 01	0910400	Low Pass Filter	1A
LF 02	0910360	Low Pass Filter	2B
VR01	1034250	4.7 kΩ (B) Volume, V.C.O	2B
VR02	1034310	47 kΩ (B) Volume, SEP	2B
VR11	1035130	10 kΩ (B) Volume, FM signal	4A
VR12	1035190	100 kΩ (B) Volume, muting	3A
VR13	1035110	4.7 kΩ (B) Volume, noise	3A
VR52	1035070	1 kΩ (B) Volume, AM signal	4B
S 01	1110240	Slide Switch, DE-EMPHASIS	1B
	0990020	Ceramic Filter	
	2410590	4P Pin Ass'y Type D	
	2410910	2P Pin Ass'y Type E	

### 4. F-2714 Front-end Pack Circuit Board (Stock No. 7510721●G-8000/801)

Conductor Side

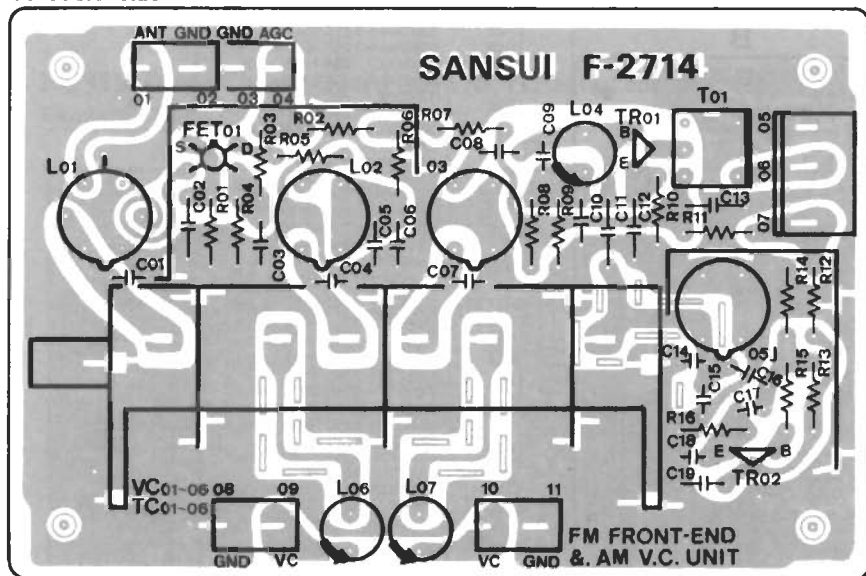

#### Parts List

Parts No.	Stock No.	Description
TR01	0306341, 2	2SC1674 L, K } Transistor
TR02	0306341, 2	2SC1674 L, K }
FT01	0370130, 1	3SK41 (I) M, L FET
C 01	0669328	18 pF 50V
C 04	0669328	18 pF 50V
C 07	0669328	18 pF 50V
C 08	0669506	6 pF 50V
C 11	0679025	0.47 pF 500V } C.C.
C 14	0669322	12 pF 50V
C 15	0669297	12 pF 50V
C 16	0669295	10 pF 50V
C 17	0669295	10 pF 50V
C 18	0669295	10 pF 50V
L 01	4200720	Antenna Coil
L 02	4210340	RF Coil
L 03	4210340	RF Coil
L 04	4900280	1.0 μH Inductor
L 05	4220400	OSC Coil
L 06	4900280	1.0 μH Inductor
L 07	4900280	1.0 μH Inductor
T 01	4235930	IF Coil
VT01	1220270	AM, FM Variable Capacitor
	2410660	2P Pin Ass'y Type F
	2410920	3P Pin Ass'y Type E

### 5. Front-end Pack Circuit Board (Stock No. 7510711●G-9000/901)

Note: As parts on the Front-end Pack would not be supplied individually, change whole the Front-end Pack Ass'y when repair.

### 6. F-2796 Equalizer AMP Circuit Board (Stock No. 7551211●G-9000/901)

Conductor Side

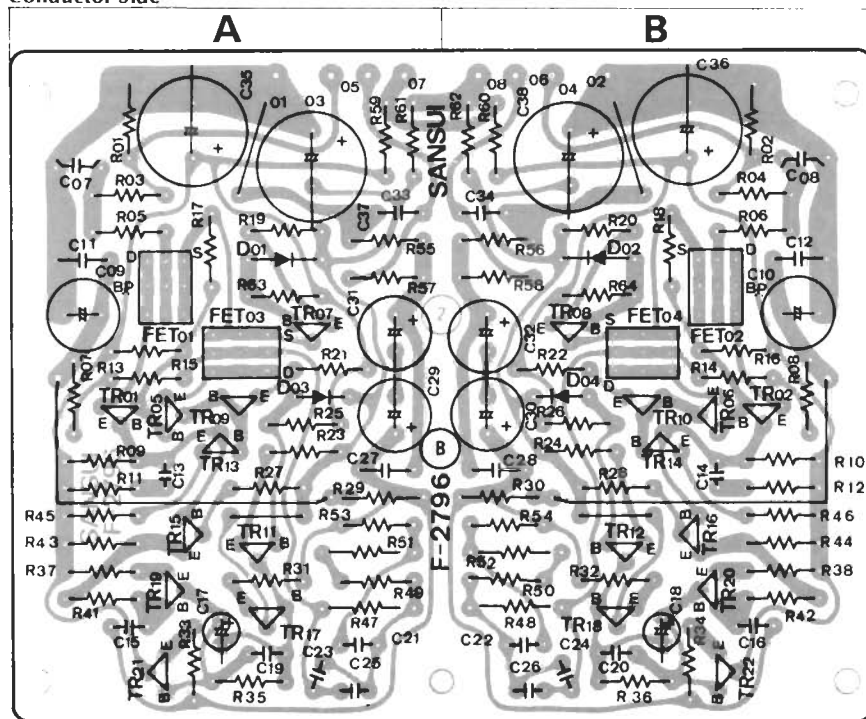

#### Parts List

Parts No.	Stock No.	Description	Position
TR01, 02	0306550, 1	2SC-1775 E, F } Transistor	A, B
TR05, 06	0306550, 1	2SC-1775 E, F }	A, B
TR07, 08	0306550, 1	2SC-1775 E, F }	A, B
TR09, 10	0300930, 1	2SA-872 D, E }	A, B
TR11, 12	0306550, 1	2SC-1775 E, F }	A, B
TR13, 14	0300930, 1	2SA-872 D, E }	A, B
TR15, 16	0300930, 1	2SA-872 D, E }	A, B
TR17, 18	0303361, 2	2SB560 E, F }	A, B
TR19, 20	0300930, 1	2SA-872 D, E }	A, B
TR21, 22	0308521, 2	2SD438 E, F }	A, B
FT01, 02	0370302, 3	2SK-117 GR, BL } FET	A, B
FT03, 04	0370302, 3	2SK-117 GR, BL }	A, B
D 01, 02	0340120	VD1212 } Varistor	A, B
D 03, 04	0340120	VD1212 }	A, B
C 07, 08	0620101	100 pF 50V	A, B
C 13, 14	0620121	120 pF 50V	A, B
C 21, 22	0625103	10000 pF 50V } P.C.	A, B
C 23, 24	0620151	150 pF 50V	A, B
C 25, 26	0625272	2700 pF 50V	A, B
R 47, 48	0231273	27 kΩ 1/4W } M.R.	A, B
R 51, 52	0231304	300 kΩ 1/4W }	A, B
	2410590	4P Pin Ass'y Type D	



**7. F-2795 Mic. AMP Circuit Board** (Stock No. 7595791●G-8000/801)  
(Stock No. 7595871●G-9000/901)

Conductor Side

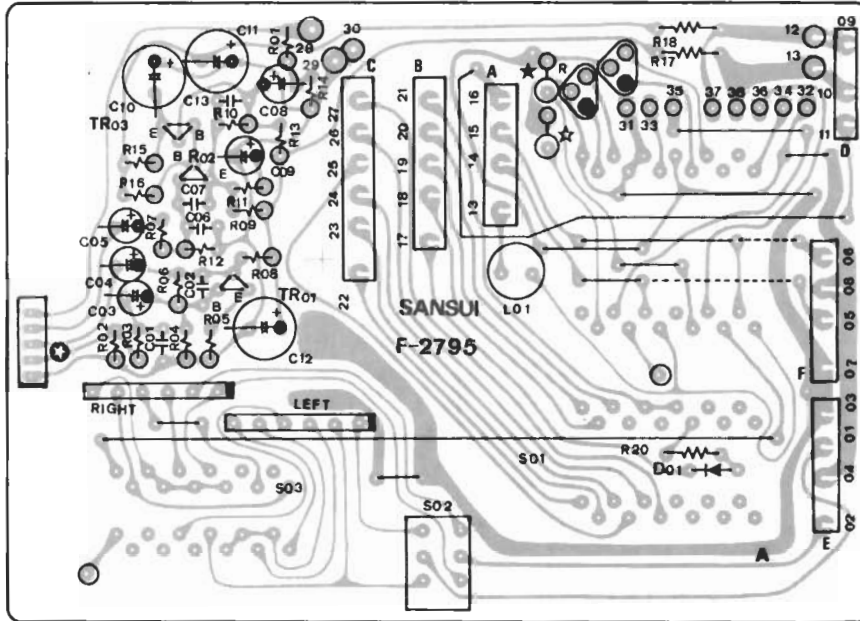

**Parts List**

Parts No.	Stock No.	Description
TR01	0306550.1	2SC-1775 E, F
TR02	0300930.1	2SA-872 D, E
TR03	0306550.1	2SC-1775 E, F
D 01	0310340	10D1 (1S2226) Diode
C 03	0573687	0.068 $\mu$ F 35V
C 05	0573687	0.068 $\mu$ F 35V T.C.
C 13	0620681	680 pF 50V P.C.
L 01	4900090	Inductor
S 01	1104370	Rotary Switch, selector
S 02	1102660	Rotary Switch, tape monitor
S 03	1131550	Push Switch, 4 CH/NR ADAPTOR
	2410570	5P Pin Ass'y Type D
	2410580	4P Pin Ass'y Type D
	2410600	6P Pin Ass'y Type D
	2410670	3P Pin Ass'y Type F

**8. F-2794 Input Terminal Circuit Board** (Stock No. 7595781●G-8000/801)  
(Stock No. 7595861●G-9000/901)

Conductor Side

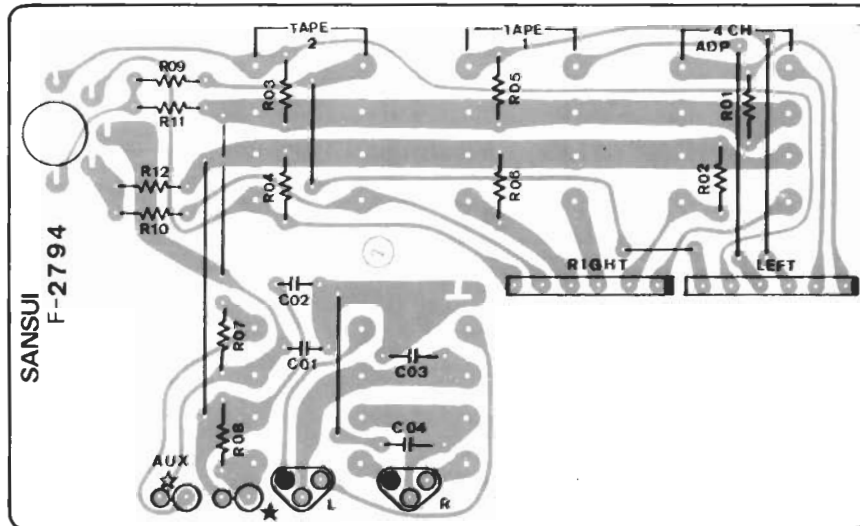

**Parts List**

Parts No.	Stock No.	Description
	2090030	5P DIN Socket
	2200490	12P Input Terminal
	2200530	6P Input Terminal

**9. F-2811 Indicator Circuit Board**  
(Stock No. 7595841●G-8000/801)  
(Stock No. 7595921●G-9000/901)

Conductor Side

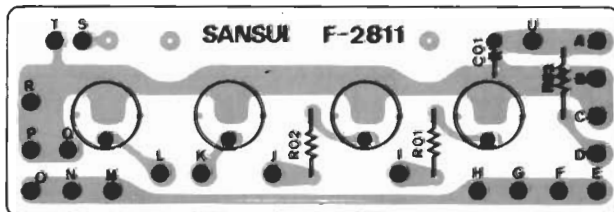

**Parts List**

Parts No.	Stock No.	Description
LD01	0319050	SG2-13C (green) LED
LD02 ~04	0319060	SG2-12C (red) LED

**10. F-2812 Selector Indicator Circuit Board**  
(Stock No. 7595851●G-8000/801)  
(Stock No. 7595931●G-9000/901)

Conductor Side

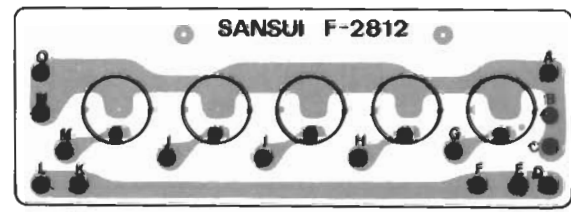

**Parts List**

Parts No.	Stock No.	Description
LD01 ~05	0319060	SG2-12C (red) LED

### 11. F-2798 Equalizer AMP Circuit Board (Stock No. 7551231●G-8000/801)

Conductor Side

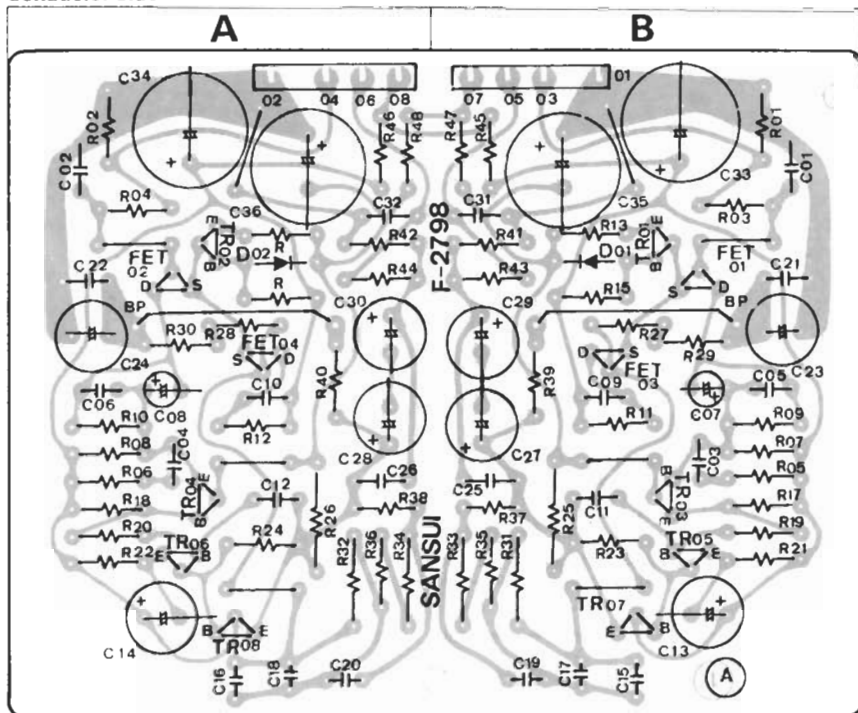

#### Parts List

Parts No.	Stock No.	Description	Position
TR01, 02	0300560, 1	2SC-1175 E, F	B, A
TR03, 04	0300890, 1	2SA-872 D, E	B, A
TR05, 06	0300930, 1	2SA-872 D, E	B, A
TR07, 08	0308521, 2	2SD438 E, F	B, A
FT01, 02	0370302, 3	2SK-117 GR, BL	B, A
FT03, 04	0370302, 3	2SK-117 GR, BL	B, A
D 01, 02	0340120	VD1212	B, A
	0340150	MV-12	Varistor
C 01, 02	0620101	100 pF 50V	B, A
C 03, 04	0620101	100 pF 50V	B, A
C 15, 16	0625272	2700 pF 50V	P.C.
C 17, 18	0620151	150 pF 50V	B, A
C 19, 20	0625103	10000 pF 50V	B, A
R 25, 26	0211392	3.9 kΩ 1W N.I.R.	B, A
R 27, 28	0231220	22 Ω 1/2W	B, A
R 29, 30	0231561	560 Ω 1/2W	B, A
R 31, 32	0231273	27 kΩ 1/2W	M.R.
R 33, 34	0231304	300 kΩ 1/2W	B, A
R 35, 36	0231153	15 kΩ 1/2W	B, A
	2410590	4P Pin Ass'y Type D	

### 12. F-2802 Tone SW Circuit Board (Stock No. 7562091●G-8000/801)

Conductor Side

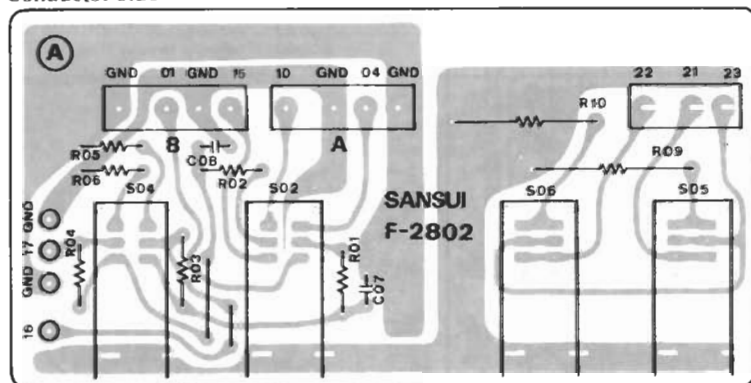

#### Parts List

Parts No.	Stock No.	Description
C 01, 02	0620221	220 pF 50V P.C.
R 09	0212681	680 Ω 2W N.I.R.
R 10	0212681	680 Ω 2W N.I.R.
S 01	1171780	Lever Switch, tone
S 02	1171780	Lever Switch, audio muting
S 04	1171780	Lever Switch, speakers A
S 05	1171780	Lever Switch, speakers B
	2410670	3P Pin Ass'y Type F
	2410680	4P Pin Ass'y Type F

### 13. F-2801 Tone SW Circuit Board (Stock No. 7562131●G-9000/901)

Conductor Side

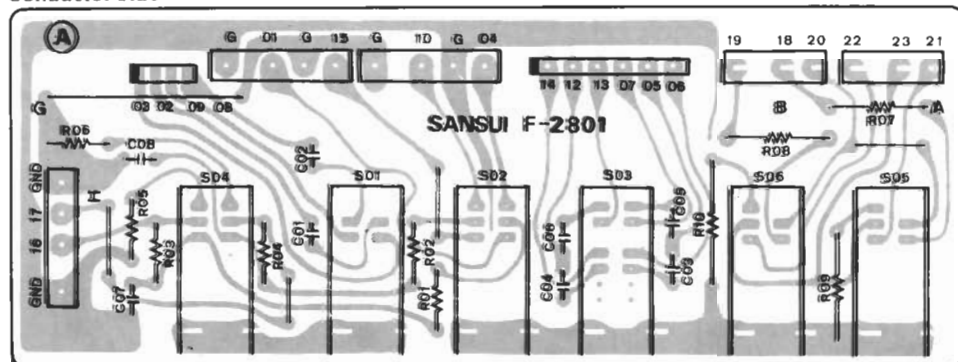

#### Parts List

Parts No.	Stock No.	Description	Parts No.	Stock No.	Description	Parts No.	Stock No.	Description
C 01, 02	0620821	820 pF 50V	S 02	1171780	Lever Switch, tone	S 06	1171780	Lever Switch, speakers B
C 07, 08	0620221	220 pF 50V	S 03	1171800	Lever Switch, turn over		2410670	3P Pin Ass'y Type F
R 09, 10	0212681	680 Ω 2W N.I.R.	S 04	1171780	Lever Switch, audio muting		2410680	4P Pin Ass'y Type F
S 01	1171780	Lever Switch, turn over	S 05	1171780	Lever Switch, speakers A			



14. F-2806 Driver AMP Circuit Board (Stock No. 7571841●G-8000/801)  
Conductor Side (Stock No. 7571861●G-9000/901)

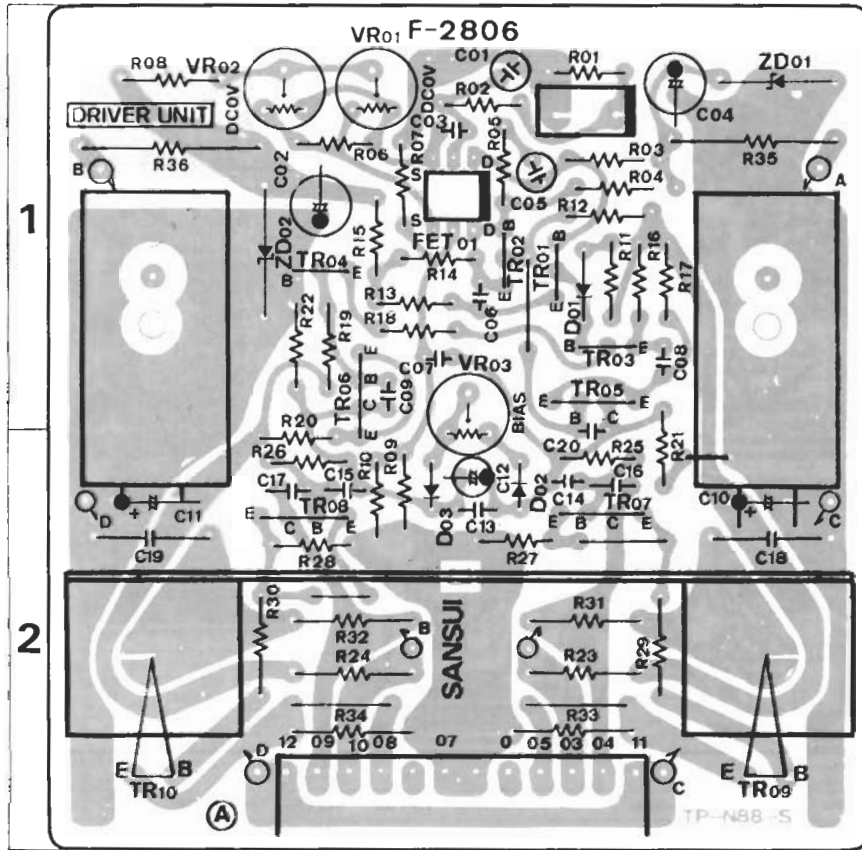

Parts List

Parts No.	Stock No.	Description	Position
TR01	0306550, 1	2SC-1775 E, F	1
TR02	0306550, 1	2SC-1775 E, F	1
TR03	0300930, 1	2SA-872 D, E	1
TR04	0300930, 1	2SA-872 D, E	1
TR05	0300700, 1	2SA-818 O, Y	1
TR06	0306260, 1	2SC-1628 O, Y	1
TR07	0306260, 1	2SC-1628 O, Y	2
TR08	0300700, 1	2SA-818 O, Y	2
TR09	0306660, 1	2SC2238 O, Y	2
TR10	0301020, 1	2SA968LB O, Y	2
FT01	0370251, 2	2SK97 FET	1
D 01	0311160	1S2473D Diode	1
D 02, 03	0340161, 2	STV-3H Y, G Varistor	2
ZD01	0316170	EQB01-22	1
ZD02	0316170	EQB01-22	1
C 01	0620101	100 pF 50V	1
C 05	0620331	330 pF 50V	P.C.
C 07	0669505	5 pF 50 V C.C.	1
C 18	0602109	1.0 μF 100 V	M.C.
C 19	0602109	1.0 μF 100 V	M.C.
R 03	0231332	3.3 kΩ 1/4W	M.R.
R 04	0231332	3.3 kΩ 1/4W	M.R.
R 08	0103392	3.9 kΩ 1/4W C.R.	1
R 23	0210470	47 Ω 1/4W	N.I.R.
R 24	0210470	47 Ω 1/4W	N.I.R.
R 29	0103479	4.7 Ω 1/4W	C.R.
R 30	0103479	4.7 Ω 1/4W	C.R.
R 31	0210100	10 Ω 1/4W	N.I.R.
R 32	0210100	10 Ω 1/4W	N.I.R.
R 33	0103560	56 Ω 1/4W	C.R.
R 34	0103560	56 Ω 1/4W	C.R.
R 35	0212332	3.3 kΩ 2W	N.I.R.
R 36	0213222	2.2 kΩ 3W	N.I.R.
VR01	1033570	100 Ω (B) Volume, DC OV	1
VR02	1035330	2.2 kΩ (B) Volume, DC OV	1
VR03	1033570	100 Ω (B) Volume, 6 <sup>1/2</sup> mA current	1
	2410660	2P Pin Ass'y Type F	
	2420520	6P Pin Connectors Type A	

15. F-2799 Tone Control Circuit Board (Stock No. 7562071●G-8000/801)  
Conductor Side (Stock No. 7562111●G-9000/901)

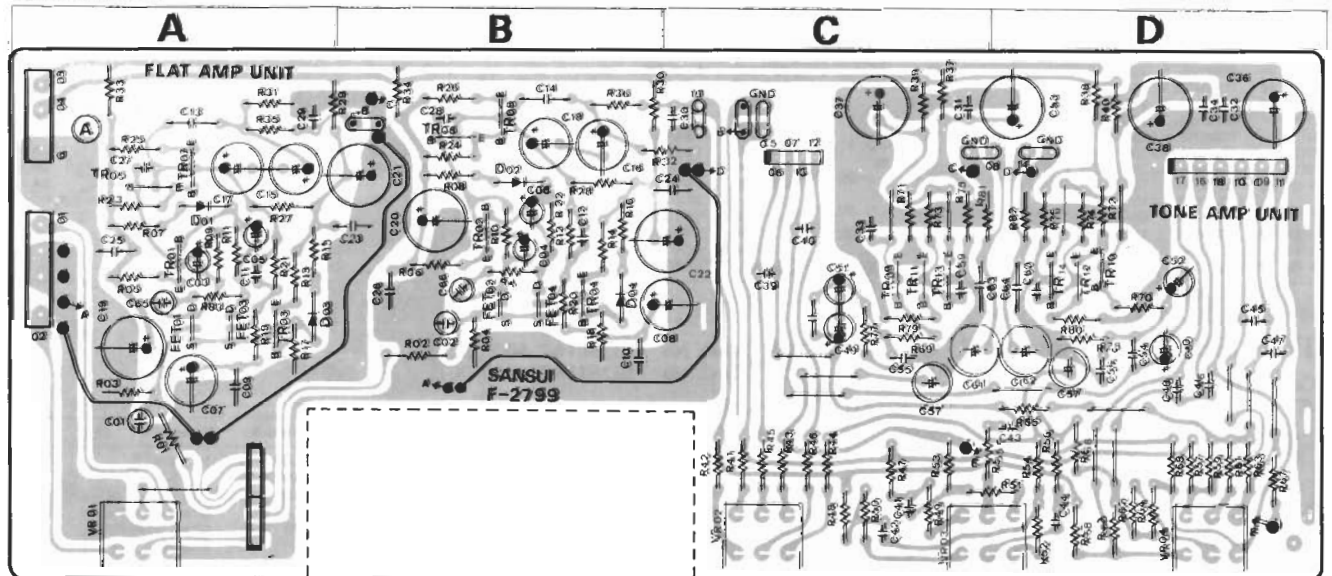

Parts List

Parts No.	Stock No.	Description	Position	Parts No.	Stock No.	Description	Position	Parts No.	Stock No.	Description	Position
TR01, 02	0300930, 1	2SA-872 D, E	A, B	FT01, 02	0370302, 3	2SK-117 GR, BL	A, B	VR02	1015290, 1	100Ω (B) x2 Volume, treble	C
TR03, 04	0306550, 1	2SC-1775 E, F	A, B	FT03, 04	0370302, 3	2SK-117 GR, BL	A, B	VR03	1015290, 1	100Ω (B) x2 Volume, midrange	C
TR05, 06	0300930, 1	2SA-872 D, E	A, B	D 01, 02	0311160	1S2473D	A, B	VR04	1015290, 1	100Ω (B) x2 Volume, bass	D
TR07, 08	0303361, 2	2SB560 E, F	A, B	D 03, 04	0311160	1S2473D	A, B				
TR09, 10	0300930, 1	2SA-872 D, E	C, D	C 65, 66	0620331	330 pF 50V P.C.	A, B				
TR11, 12	0300930, 1	2SA-872 D, E	C, D	R 27, 28	0210682	6.8 kΩ 1/4W N.I.R.	A, B				
TR13, 14	0306610, 1	2SC1222 (B) U, E	C, D	VR01	1015340, 1	250Ω (B) MN x2 Volume, balance	A				

**16. F-2809 AF Power Supply and Protector Circuit Board** (Stock No. 7571851●G-8000/801)  
(Stock No. 7571871●G-9000/901)

Conductor Side

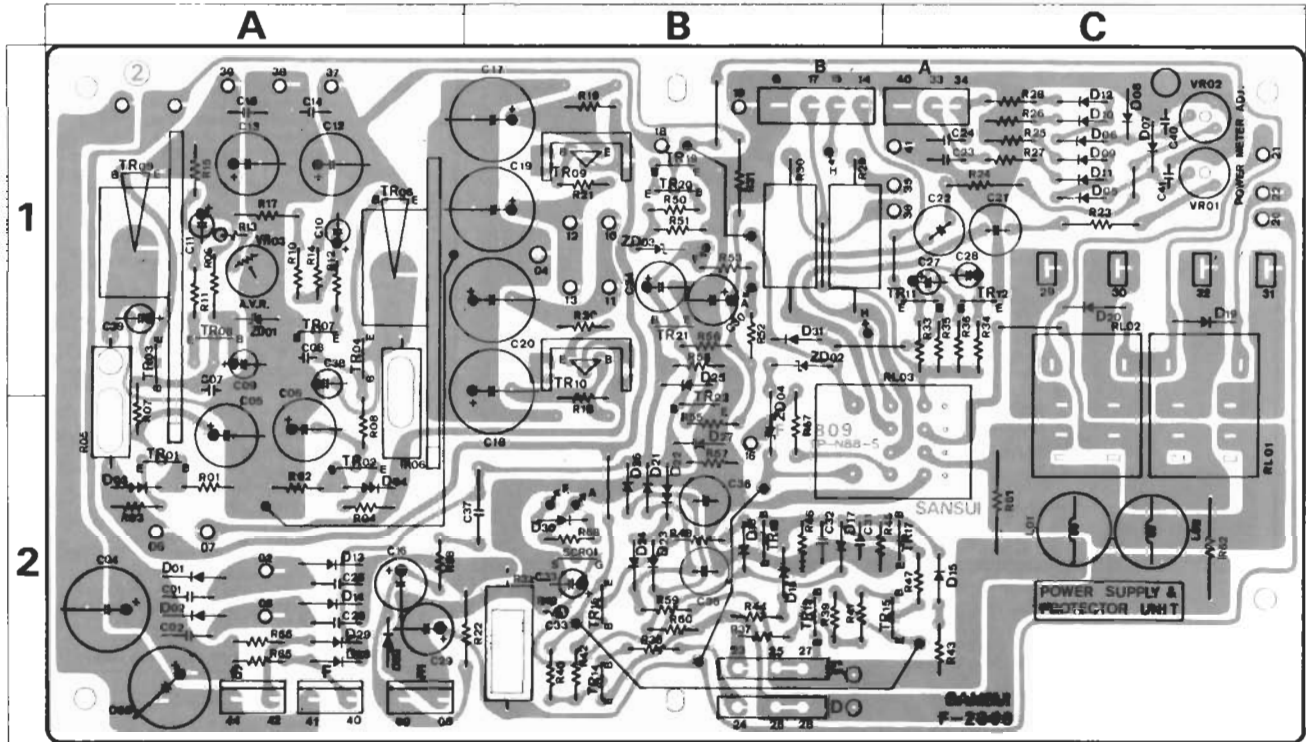

**Parts List**

Parts No.	Stock No.	Description	Position	Parts No.	Stock No.	Description	Position	Parts No.	Stock No.	Description	Position
TR01	0300721, 2	2SA 850 D, E	2C	D 11, 12	0311060	1N60-P	1A	ZD03	0316400	RD6.2E C	1B
TR02	0306281, 2	2SC-1735 D, E	2C	D 13, 14	0310340	10D1 (1S2226)	2C	ZD04	0315061	EQB01-12	2B
TR03	0305950 ~ 2	2SC-945 R, Q, P	1C	D 15, 16	0311160	1S-2473D	2A, B	SR01	0350020	2SF-656 SCR	2C
TR04	0300680 ~ 2	2SA-733 (2) P, Q, R	1C	D 17, 18	0311180	1S-1588	2B	C 01, 02	0655103	10000 pF 500V	C.C.
TR05	0308412, 3	2SD 314 E, F	1C	D 19	0310340	10D1 (1S2226)	1A	C 25, 26	0655103	10000 pF 500V	2C
TR06	0303420, 1	2SB 508 D, E	1C	D 20	0310340	10D1 (1S2226)	1A	C 37	0602338	0.33 μF 100 M.C.	2B
TR07	0305950 ~ 2	2SC-945 R, Q, P	1C	D 21, 22	0311160	1S2473D	2B	R 05	0213331	330 Ω 3W	2C
TR08	0300680 ~ 2	2SA-733 (2) P, Q, R	1C	D 23, 24	0311180	1S-1588	2B	R 06	0213271	270 Ω 3W	2C
TR09	0308521, 2	2SD 438 E, F	1B	D 25	0311160	1S-2473D	1B	R 09	0210272	2.7 kΩ ½W	1C
TR10	0303361, 2	2SB 560 E, F	1B	D 26	0340120	VD1212	2B	R 22	0211221	220 Ω 1W	2C
TR11	0305951 ~ 3	2SC-945 Q, P, K	1A	D 27	0311160	1S-2473D	2B	R 23, 24	0201471	470 Ω 1W	1A
TR12	0305951 ~ 3	2SC-945 Q, P, K	1A	D 28, 29	0311180	1S-1588	2C	R 29, 30	0135221	220 Ω 5W	1B
TR13, 14	0306550, 1	2SC-1775 E, F	2B	D 30, 31	0311160	1S-2473D	2B, 1B	R 31	0210223	22 kΩ ½W	1B
TR15, 16	0300930, 1	2SA-872 D, E	2A, B	D 32	0310340	10D1 (1S2226)	1A	R 32	0135101	100 Ω 5W Ce.R	2B
TR17, 18	0306390, 1	2SC-1636 (1), (2)	2A, B	ZD01	0316390	RD6.2E, B	1C	R 61, 62	0212229	2.2 Ω 2W	2A
TR19	0308521, 2	2SD-438 E, F	1B	ZD02	0315061	EQB01-12	1B	R 67	0210681	680 Ω ½W	2B
TR20	0305951 ~ 3	2SC-945 Q, P, K	1B					L 01, 02	4210290	1.5 μH Coil	2A
TR21	0305951 ~ 3	2SC-945 Q, P, K	1B					RL01, 02	1150410	Relay	2A
TR22	0305951 ~ 3	2SC-945 Q, P, K	2B					RL03	1150101	Relay	2A
D 01, 02	0310340	10D1 (1S2226) Diode	2C					VR01, 02	1034250	4.7 kΩ (B) Volume, power meter	
D 03, 04	0340120	VD1212	2C						2410670	3P Pin Ass'y Type F	
D 05, 06	0340150	MV-12	2C						2410680	4P Pin Ass'y Type F	
D 07, 08	0311060	1N60-P	1A						2410910	2P Pin Ass'y Type E	
D 09, 10	0311160	1S-2473D	1A						2411360	3P Miniature Plug	

**17. F-2807 Power Supply (R) Circuit Board** (Stock No. 7502661●G-8000/801)  
(Stock No. 7502631●G-9000/901)

Conductor Side

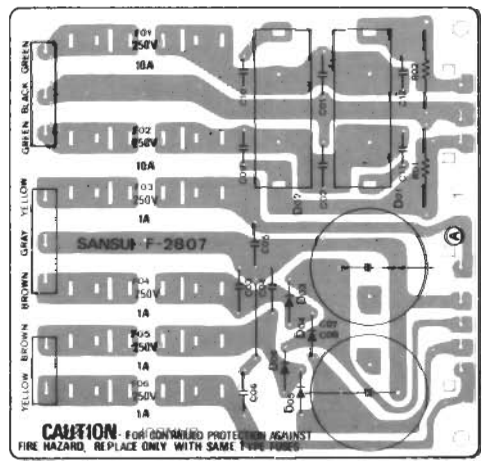

**Parts List**

Parts No.	Stock No.	Description	Parts No.	Stock No.	Description
D 01	0311310	SS-5	F 05	0432220	1A 250V
D 02	0311320	SS-5R	F 06	0432220	1A 250V
D 03	0310340	10D1 (1S2226)		2310220	Fuse Holder
D 04	0310340	10D1 (1S2226)		2411400	3P Miniature Plug
D 05	0310340	10D1 (1S2226)		2411420	5P Miniature Plug
D 06	0310340	10D1 (1S2226)		2411450	2P Plug
C 01	0655223	22000 pF 500V			
C 02	0655223	22000 pF 500V			
C 03	0655103	10000 pF 500V			
C 04	0655103	10000 pF 500V			
C 05	0655103	10000 pF 500V			
C 06	0655103	10000 pF 500V			
C 07	0549302	1000 pF 80V			
C 08	0549302	1000 pF 80V			
C 09	0655103	10000 pF 500V			
C 10	0655103	10000 pF 500V			
C 11	0655103	10000 pF 500V			
C 12	0655103	10000 pF 500V			
R 01	0202822	8.2 kΩ 2W			
R 02	0202822	8.2 kΩ 2W			
F 01	0434060	10A 250V			
F 02	0434060	10A 250V			
F 03	0432220	1A 250V			
F 04	0432220	1A 250V			

**18. F-2808 Power Supply (L) Circuit Board**  
(Stock No. 7502671●G-8000/801)  
(Stock No. 7502641●G-9000/901)

Conductor Side

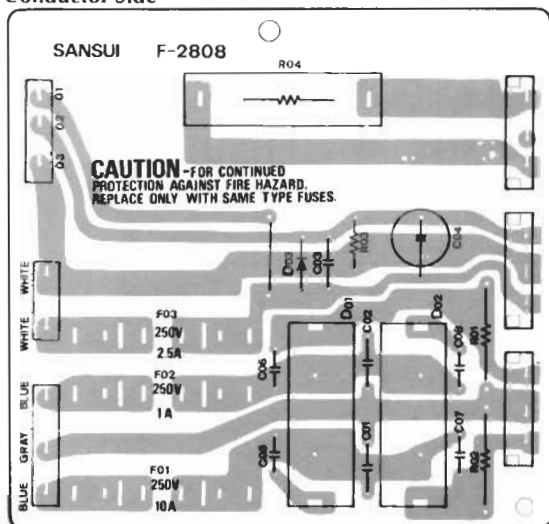

**Parts List**

Parts No.	Stock No.	Description
D 01	0311310	SS-5 Diode
D 02	0311320	SS-5R Diode
D 03	0310340	10D1 (1S2226) Diode
C 01	0655223	22000 pF 500V C.C.
C 02	0655223	22000 pF 500V C.C.
C 05	0655103	1000 pF 500V C.C.
C 06	0655103	10000 pF 500V C.C.
C 07	0655103	10000 pF 500V C.C.
C 08	0655103	10000 pF 500V C.C.
R 01	0202822	8.2 kΩ 2W N.I.R.
R 02	0202822	8.2 kΩ 2W N.I.R.
R 04	0259399	3.9 Ω 15W Ce.R.
F 01	0434060	10A 250V AC fuse
F 02	0434060	10A 250V AC fuse
F 03	0432250	2.5A 250V AC fuse
	2310220	Fuse Holder
	2411360	3P Miniature Plug
	2411400	3P Miniature Plug
	2411450	2P Plug

**19. F-2814 Driver Connection Circuit Board**  
(Stock No. 7595821●G-8000/801)  
(Stock No. 7595901●G-9000/901)

Conductor Side

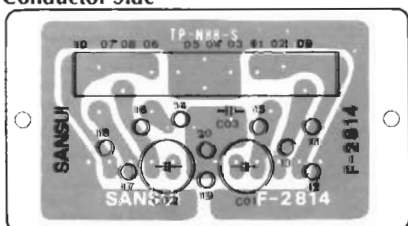

### 24. F-2797 FM Accessory SW Circuit Board

(Stock No. 7595801●G-8000/801)  
(Stock No. 7595881●G-9000/901)

Conductor Side

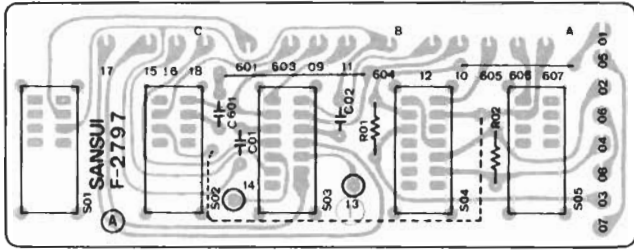

#### Parts List

Parts No.	Stock No.	Description
S 01	1171780	Lever Switch, FM IF BAND ◀G 9000/901▶
S 02	1171780	Lever Switch, FM AUTO NOISE FILTER
S 03	1171780	Lever Switch, Dolby FM, DE-EMPHASIS
S 04	1171800	Lever Switch, MODE
S 05	1171780	Lever Switch, FM MUTING
	2410680	4P Pin Ass'y Type F
	2410700	8P Pin Ass'y Type F

### 25. F-2800 Volume Circuit Board

(Stock No. 7562081●G-8000/801)  
(Stock No. 7562121●G-9000/901)

Conductor Side

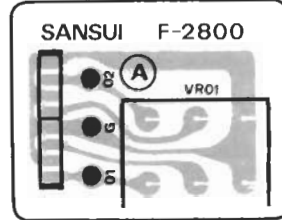

#### Parts List

Parts No.	Stock No.	Description
VR01	1011150	150 kΩ x 2 Volume, level

## 5. OTHER PARTS

<Top View> ◀G-9000▶

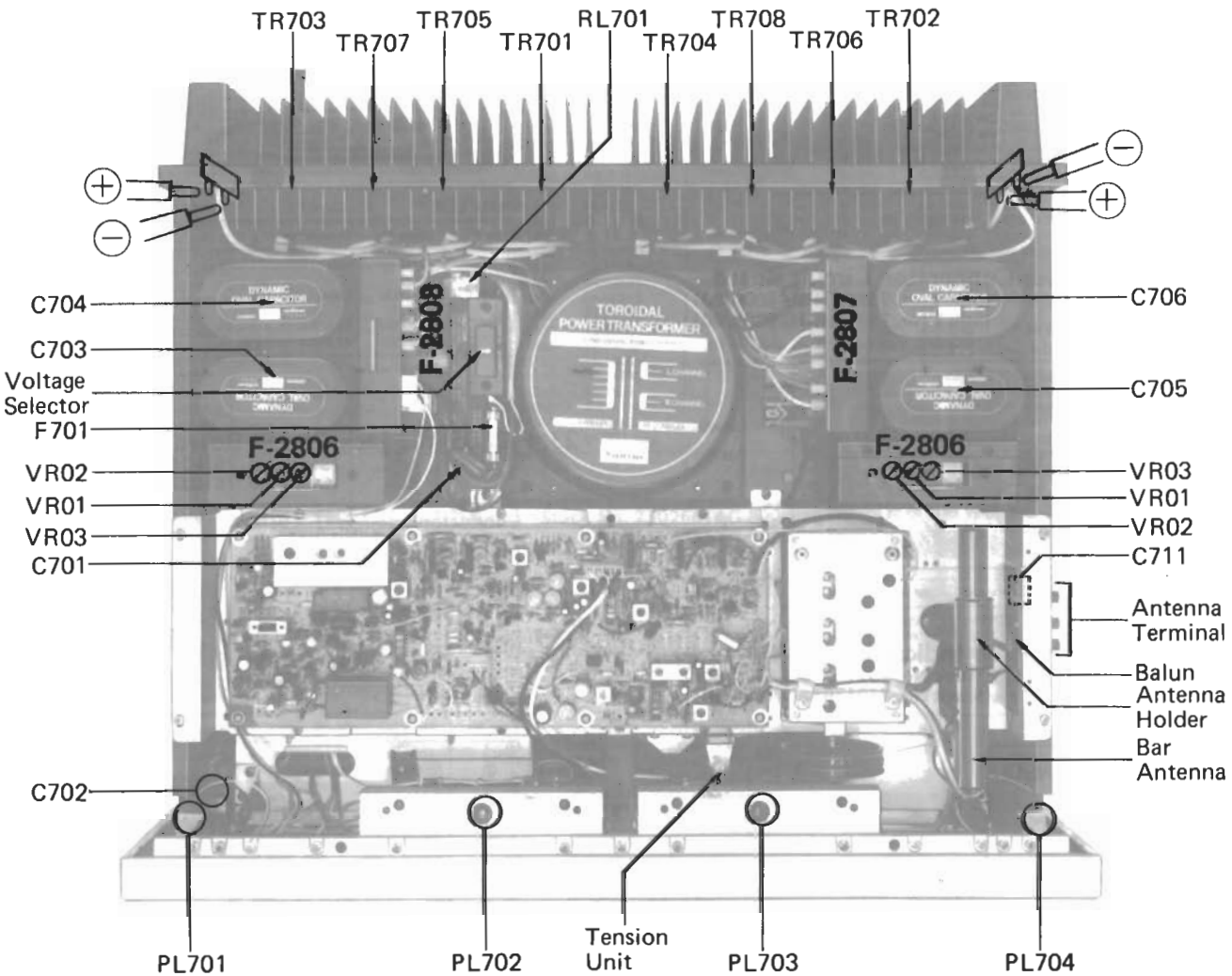

<Bottom View> <<G-9000>>

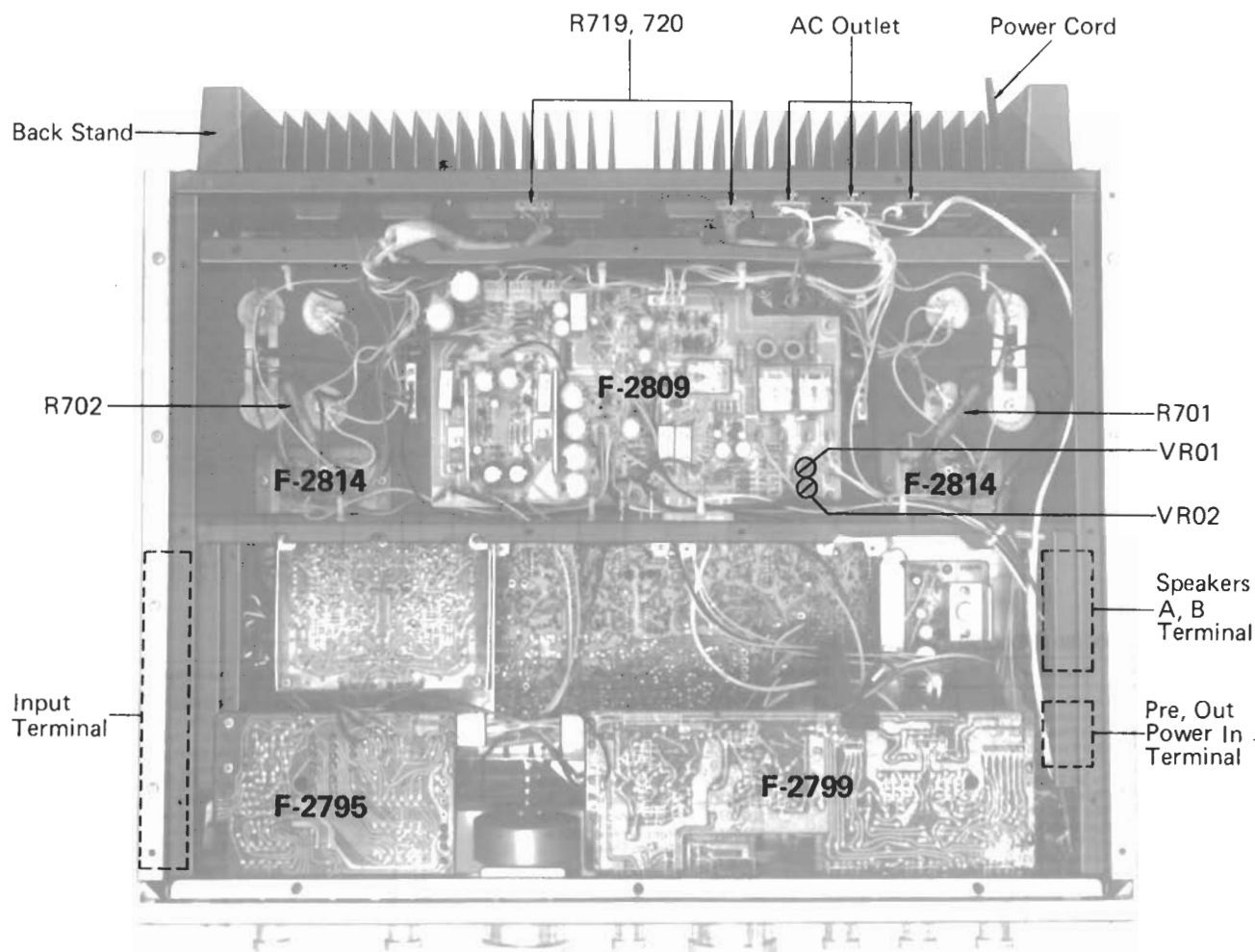

<Top, Bottom View> <<G-8000/801/9000/901>>

Parts No.	Stock No.	Description	Parts No.	Stock No.	Description	Parts No.	Stock No.	Description
TR 701 ~ 04	0306620 ~ 2	2SC 1403 (B) R. O. Y G-8000/801	C 705	0559846	15000 $\mu$ F 80V } E.C. (G-9000/901)	RL 701	1150440	Relay
	0306630 ~ 2	2SC-1586 R. O. Y G-9000/901	C 706	0559846	15000 $\mu$ F 80V	PL 701 ~ 04	0400560	8V 0.3A Lamp
TR 705 ~ 05	0300990 ~ 2	2SA-745 (B) R. O. Y G-8000/801	C 707	0602109	1 $\mu$ F 100V	F 701	0434060	10A 250V Power Fuse (G-8000/801)
	0301010 ~ 2	2SA-909 R. O. Y G-9000/901	C 708	0602109	1 $\mu$ F 100V		0434100	12A 125V Power Fuse (G-9000/901)
C 701	0603337	0.033 $\mu$ F 125V M.C. UL	C 709	0602109	1 $\mu$ F 100V } M.C. (G-9000/901)		2310250	Fuse Holder
	0605337	0.033 $\mu$ F 250V M.C.	C 710	0602109	1 $\mu$ F 100V		2410091	Voltage Selector, plug
	0635337	0.033 $\mu$ F 125V M.C. CS	C 712 ~ 15	0602109	1 $\mu$ F 100V		2410830	Voltage Selector, socket
	0603476	0.0047 $\mu$ F 125V M.C. UL	R 701.02	0205100	10 $\Omega$ 5W N.I.R.		2450060	AC Outlet
C 702	0635476	0.0047 $\mu$ F 125V P.C. CS	R 703 ~ 10	0200479	4.7 $\Omega$ 1/2W N.I.R.		3800240	Power Cord
	0659802	0.0047 $\mu$ F 150V P.C.	R 711 ~ 18	0155338	0.33 $\Omega$ 5W Ce R		3910490	Cord Stopper
C 721, 722	0559847	6800 $\mu$ F 71V	R 719, 20	0320120	Thermistor		2210310	Antenna Terminal
C 723, 724	0559847	6800 $\mu$ F 71V } E.C. (G-8000/801)	L 701	4290023	Balun		2290190	Speaker A, B, Terminal
C 725, 726	0559847	6800 $\mu$ F 71V	L 711	4200870	Bar Antenna		7136120	Tension Unit
C 727, 728	0559847	6800 $\mu$ F 71V		5289280	Antenna Holder		5216100	Back Stand (G-8000/801)
C 703	0559846	15000 $\mu$ F 80V } E.C. (G-9000/901)	PT 01	4002750	Power Transformer (G-8000/801)		5216110	Back Stand (G-9000/901)
C 704	0559846	15000 $\mu$ F 80V		4002740	Power Transformer (G-9000/901)		2230190	Grand Terminal

- Note: 1. To replace the Power transistor, remove the heat sink of the backside of the set first.
2. Shield cases covering Driver Circuit Board F-2806, are distinguished between air-tight type by the FM Pack and the other.

<Front View> <<G-9000>>

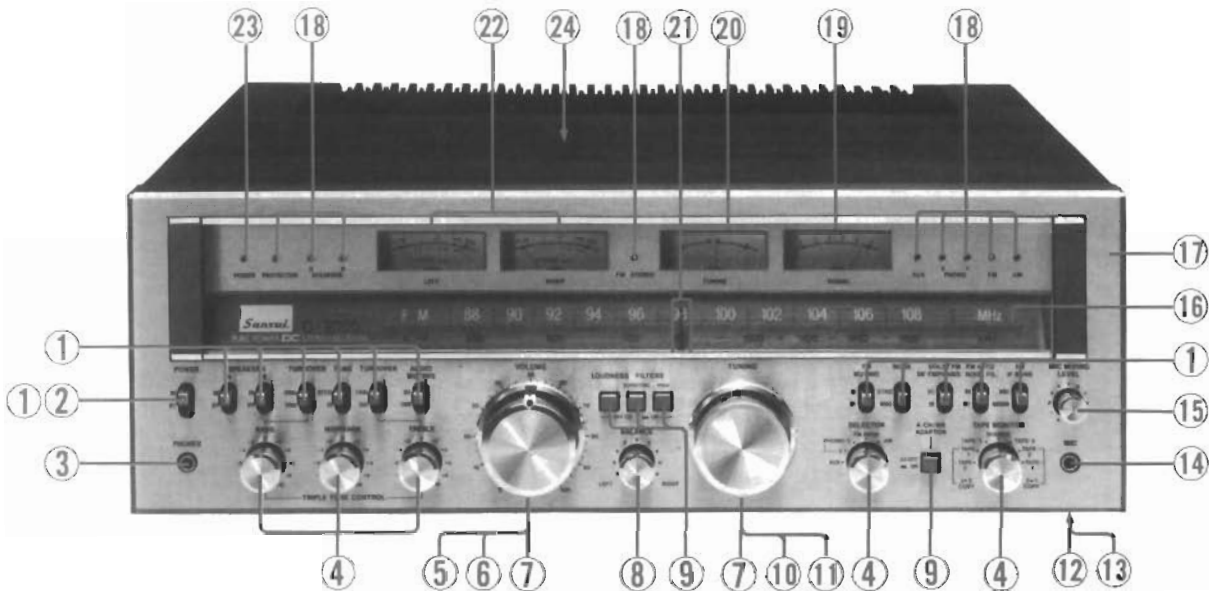

Parts List <<G-8000/801/9000/901>>

Parts No.	Stock No.	Description	Parts No.	Stock No.	Description	Parts No.	Stock No.	Description
1	5326700	Lever Switch Knob	15	5319120	US-1 Type Knob	5396380	5396380	Square Knob Ring
2	1171600	Lever Switch, power	16	5408283	Dial Scale <<G-8000>>	5289290	5289290	Fixing Plate
3	2430190	Head Phone Jack		5408420	Dial Scale <<G-801>>	18	0319060	SG2-12C (Red) LED
4	5319100	SS-4 Type Knob		5408273	Dial Scale <<G-9000>>	19	4301180	Signal Meter
5	5319010	R-7 Type Knob		5408410	Dial Scale <<G-901>>	20	4301190	Tune Meter
6	7126020	Pre Set Stopper	17	5301081	Front Panel <<G-8000>>	21	7116040	Dial Pointer Ass'y
7	5296172	Grille		5301620	Front Panel <<G-801>>	22	4301200	Power Meter
8	5319090	SS-3 Type Knob		5301071	Front Panel <<G-9000>>	23	0319050	SG2-13C (Green) LED
9	5326690	Push Switch Knob		5310610	Front Panel <<G-901>>	24	5727081	Wood Bonnet
10	5319020	U-7 Type Knob		5058830	Masking Sheet			
11	7036560	Tuning Unit Ass'y		5408243	Front Glass			
12	5066350	Bottom Plate		5507180	Front Glass Packing			
13	5517050	Leg		5305920	Dial Frame (R)			
14	2430400	Mic Jack		5305930	Dial Frame (L)			

• Figures

Connectors

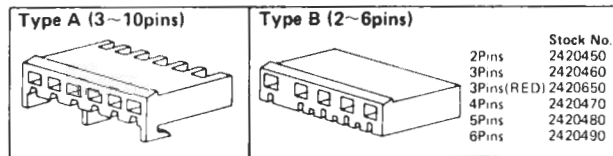

NOTE: Since stock number of female connectors (type B) with wires are not shown in each parts list of Complete circuit board, please refer to the above parts list when ordering the connector.

Pin Ass'y

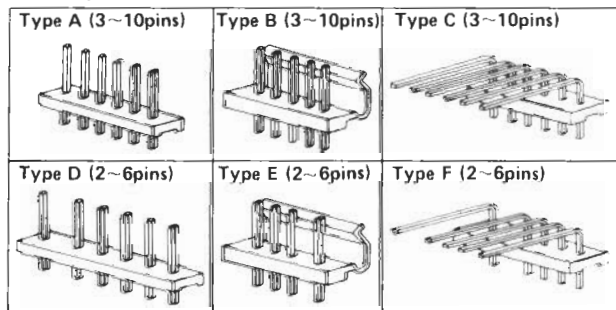

• Abbreviations

C.R.	: Carbon Resistor	E.C.	: Electrolytic Capacitor
S.R.	: Solid Resistor	BP.E.C.	: Bi-Polar Electrolytic Capacitor
Ce.R.	: Cement Resistor	C.C.	: Ceramic Capacitor
M.R.	: Metal Film Resistor	Mi.C.	: Mica Capacitor
F.R.	: Fusing Resistor	O.C.	: Oil Capacitor
N.I.R.	: Non-Inflammable Resistor	P.C.	: Polystyrene Capacitor
M.C.	: Mylar Capacitor	E.C.	: Tantalum Capacitor



# 6. SCHEMATIC DIAGRAM 1. «G-8000/801» Tuner Section

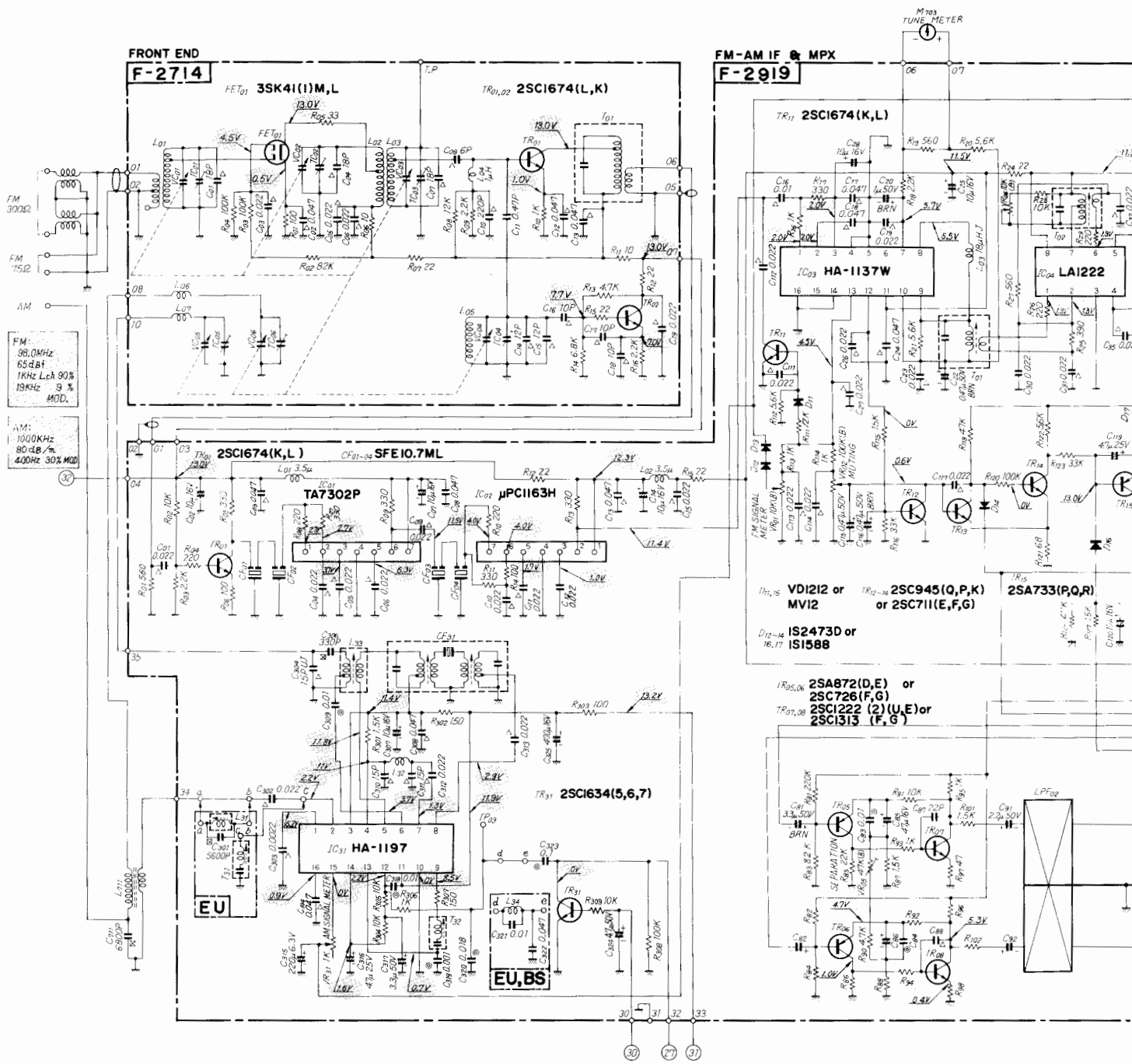

E F G H

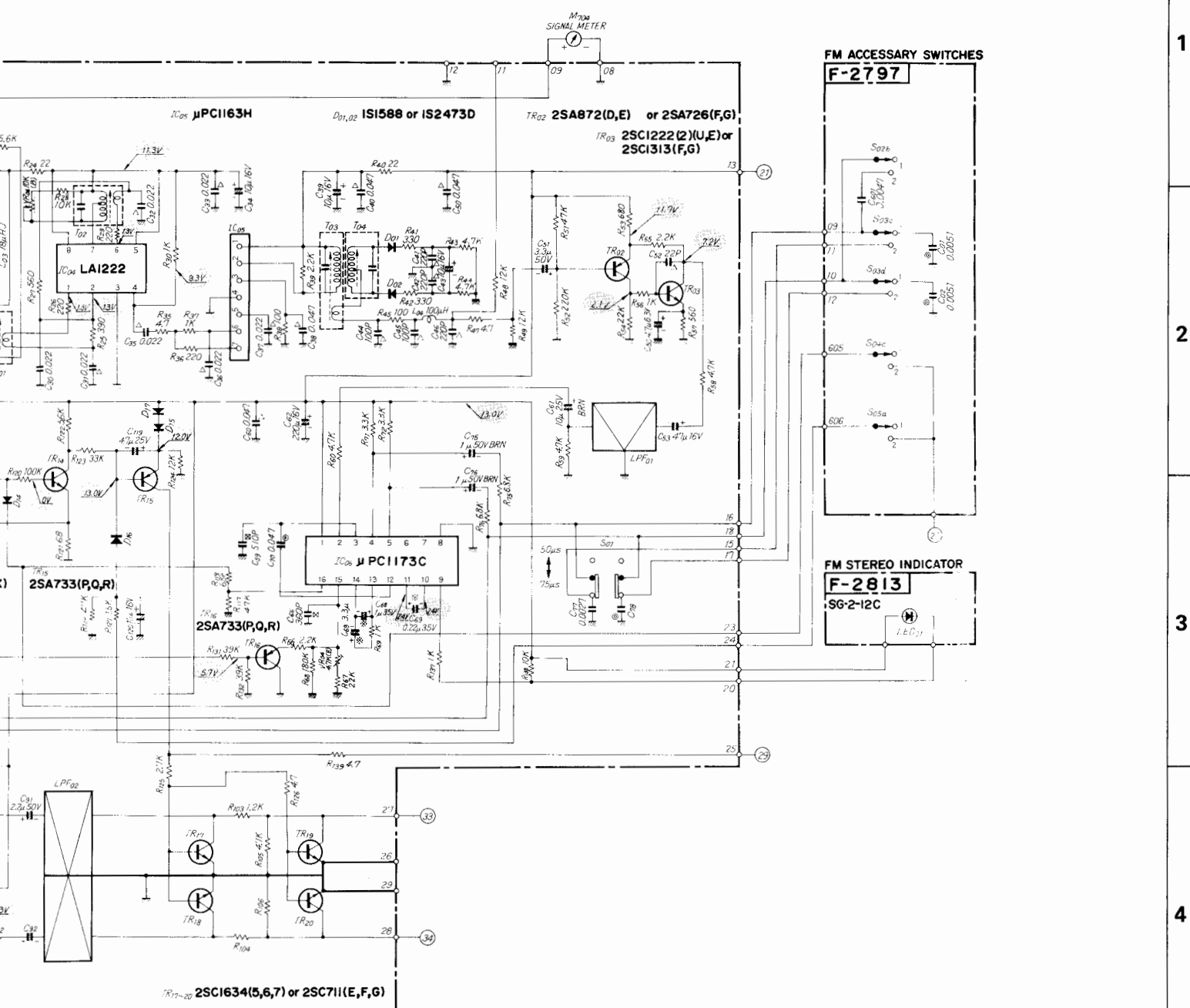

1  
2  
3  
4  
5



2. «G-8000/801» Audio Section

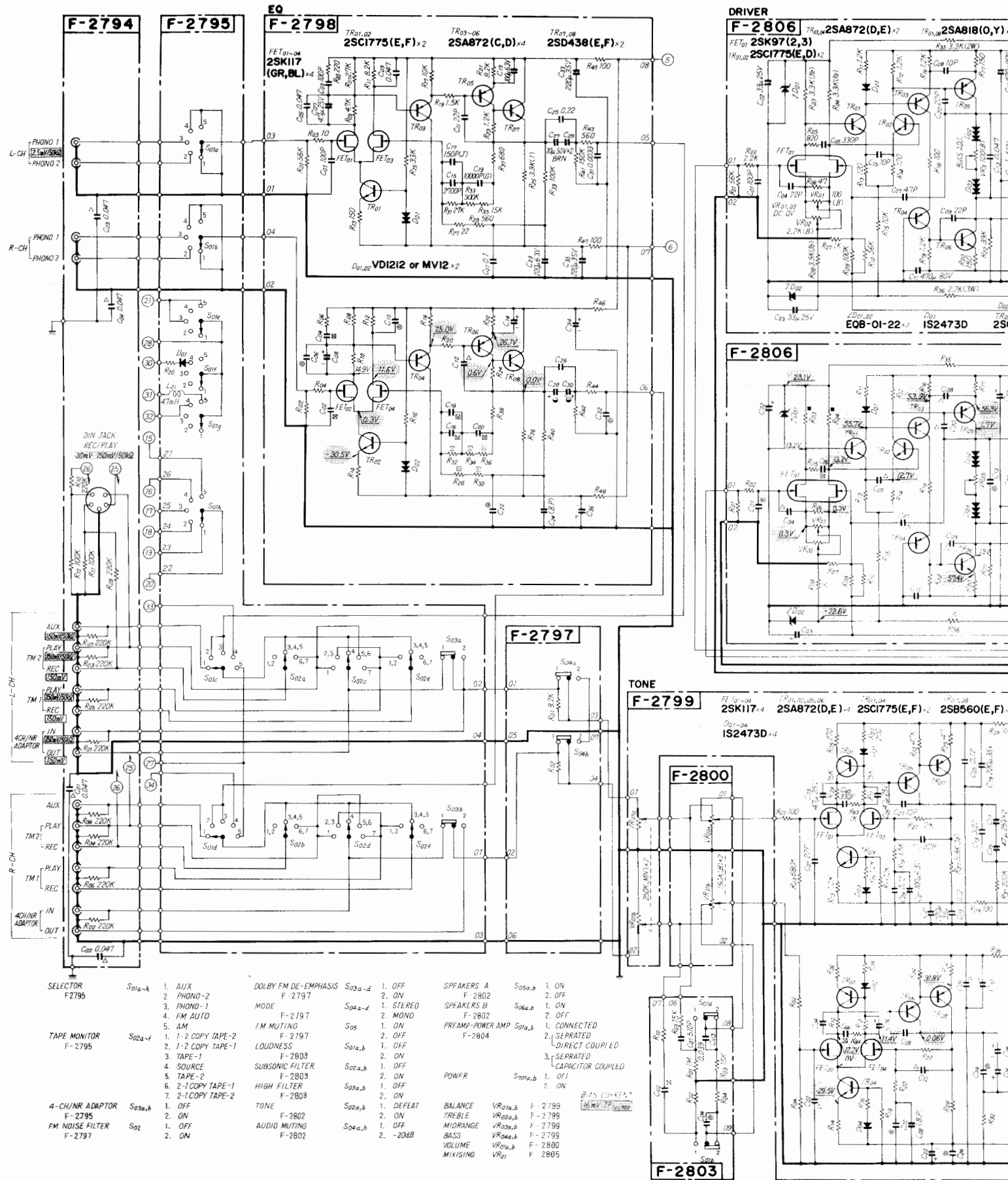

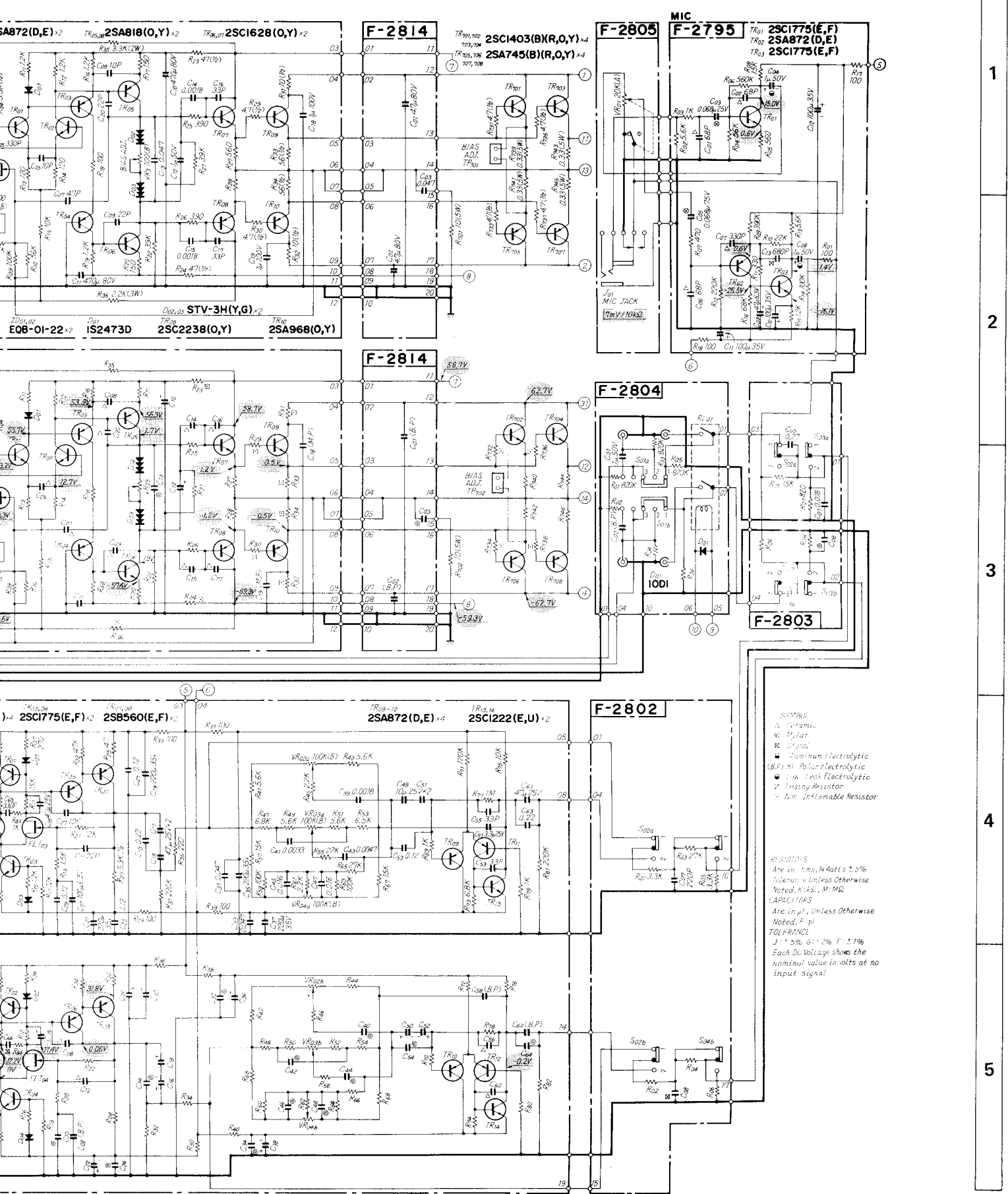

SYMBOLS:  
 (C) Electrolytic  
 (P) Polar  
 (R) Resistor  
 (M) Minimum Electrolytic  
 (E) Pol. Electrolytic  
 (U) Non-Pol. Electrolytic  
 (I) Insulating  
 (F) Inflammable Resistor

RESISTORS:  
 Are in  $\Omega$ ,  $k$  or  $M$ , unless otherwise noted. A, K, M, MS  
 CAPACITORS:  
 Are in  $\mu$ , unless otherwise noted. P,  $\mu$   
 TOLERANCE:  
 J:  $\pm 5\%$  G:  $\pm 2\%$  F:  $\pm 1\%$   
 Each DC Voltage shows the nominal value in volts at no input signal

1  
2  
3  
4  
5

A	B	C	D
---	---	---	---

### 3. «G-8000/801» Power Supply Section

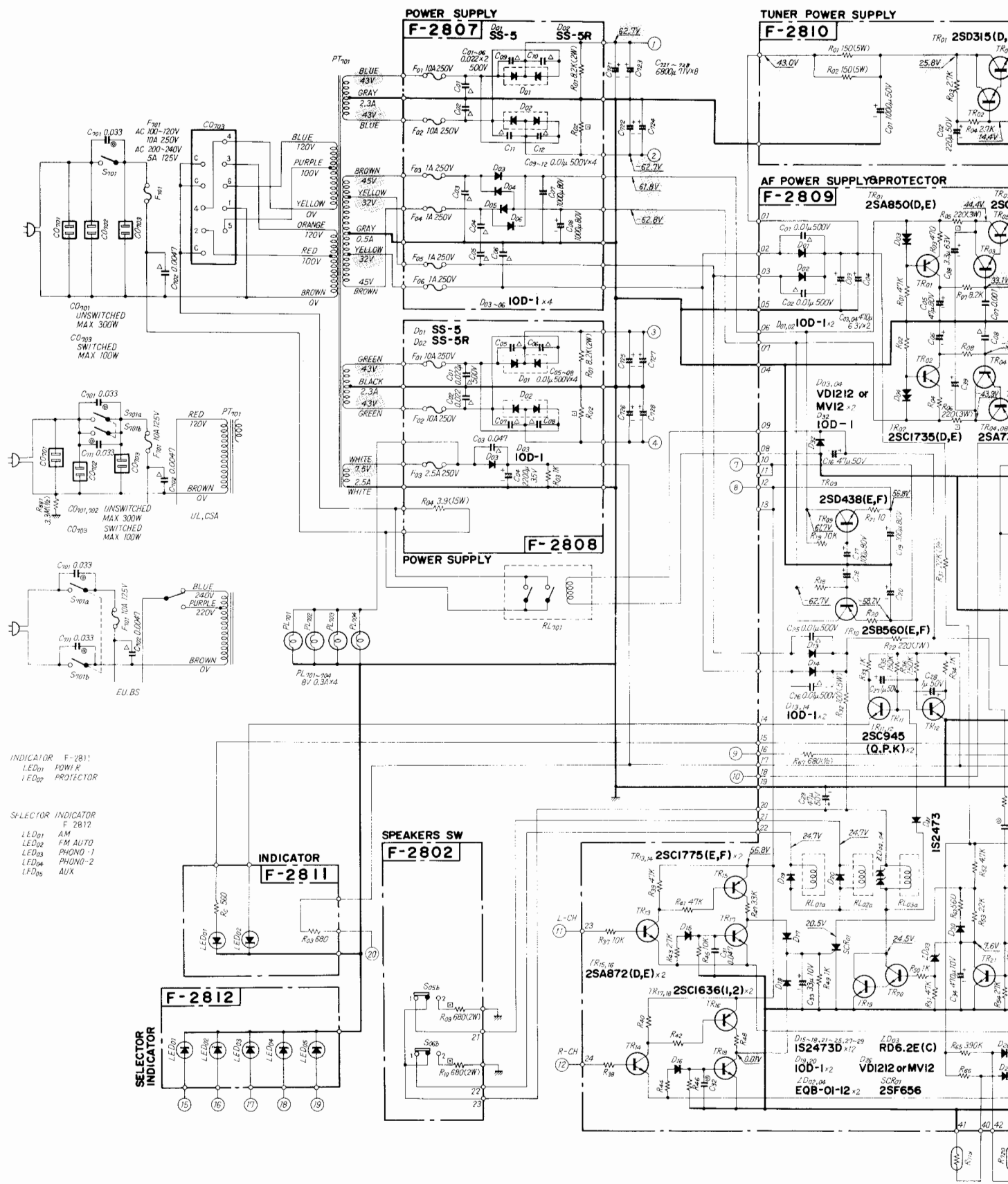

E F G H

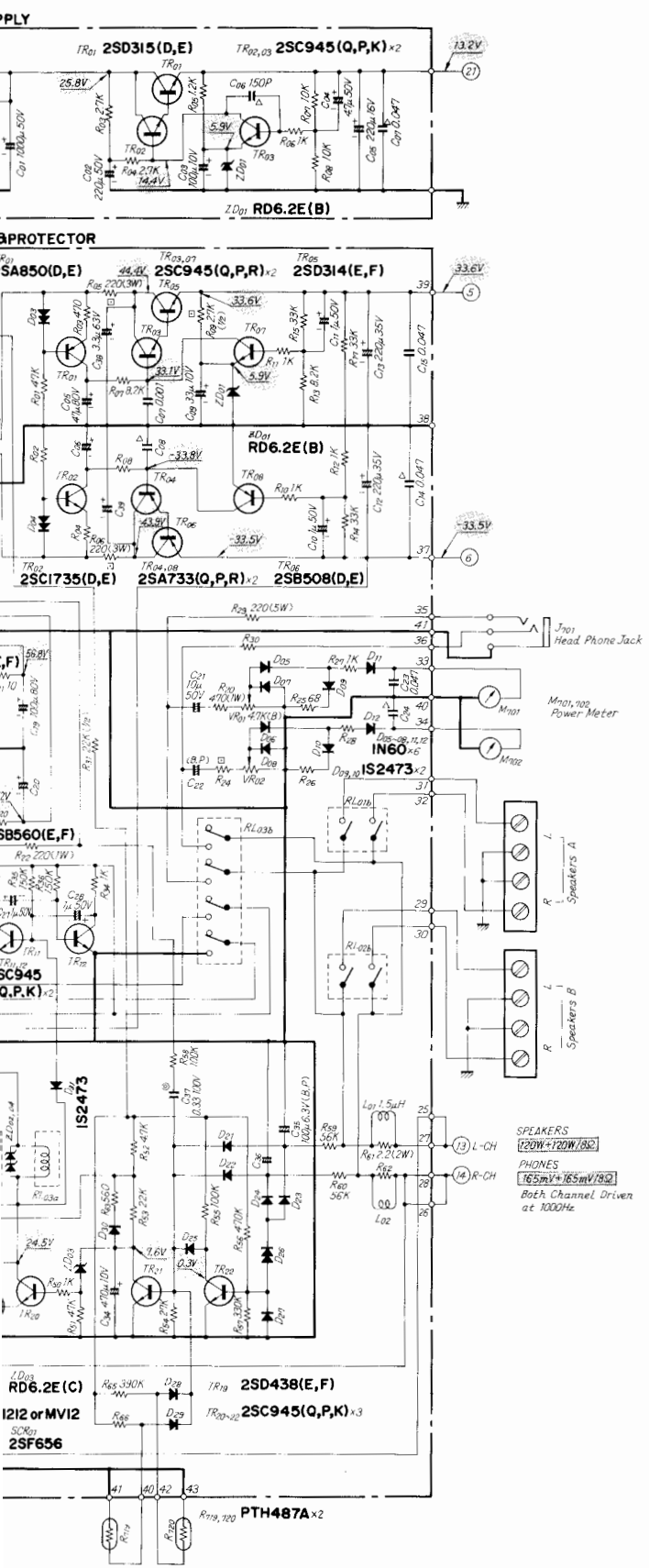

- 2SA872
- 2SA733
- 2SB560
- 2SC1775
- 2SC945
- 2SC1222
- 2SC1674
- 2SC1634
- 2SD438
- 3SK41
- 2SA818
- 2SC1628
- 2SA968
- 2SB508
- 2SC2238
- 2SD314
- TA7302P
- μPC1163H
- 2SC1636
- 2SA745
- 2SD315
- HA1137W
- HA1196
- HA1197
- 2SA726
- 2SA850
- 2SC711
- 2SC1735
- 2SC1313
- 2SK97
- LA1222
- 2SK117
- VD1212
- MV12
- 1S2473D
- 1S1588
- 1N60P
- 1S2226
- STV3H
- SS5
- SS5R
- 10D1
- EQB01-22
- EQB01-12
- 2SF656

SPEAKERS  
120W+120W/8Ω  
PHONES  
165mV+165mV/32Ω  
Both Channel Driven at 1000Hz

1  
2  
3  
4  
5

A	B	C	D
---	---	---	---

4. «G-9000/901» Tuner Section

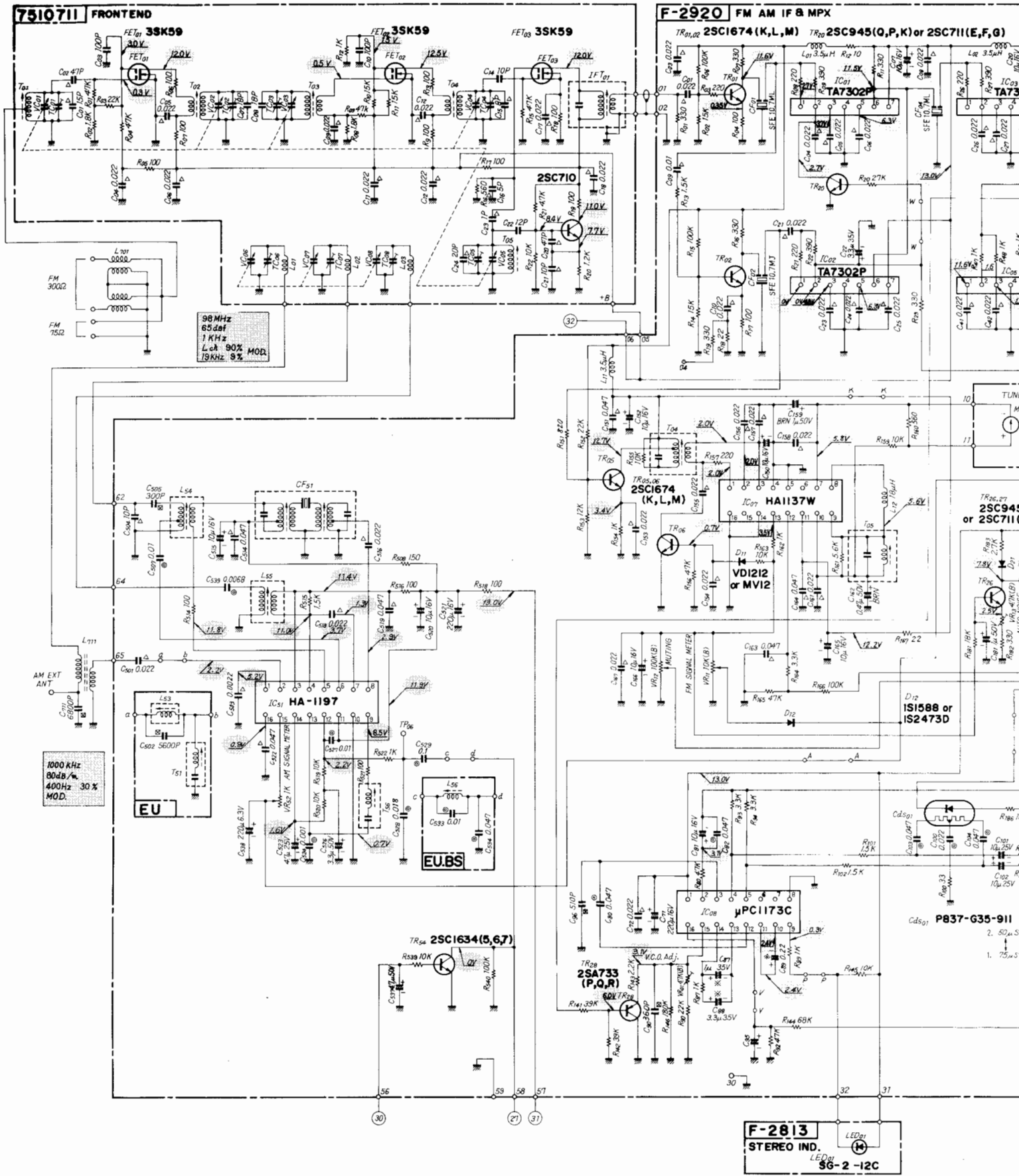

2SC945(O,P,K) or 2SC711(E,F,G)

TR03,04 2SC1674(K,L,M)

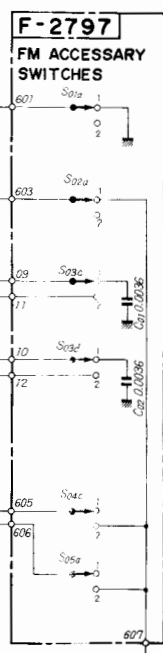
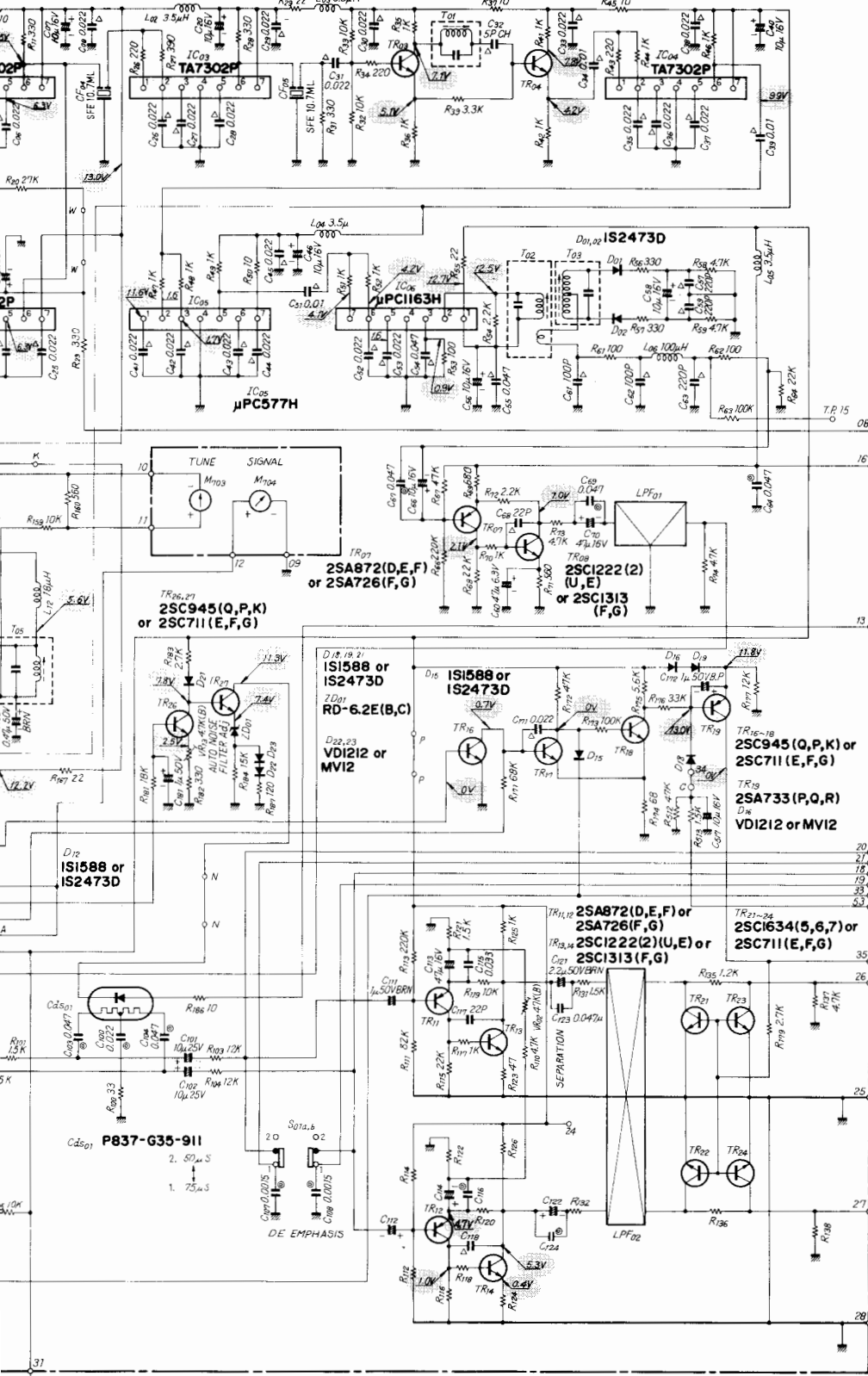

-12C

1  
2  
3  
4  
5

A B C D

5. «G-9000/901» Audio Section

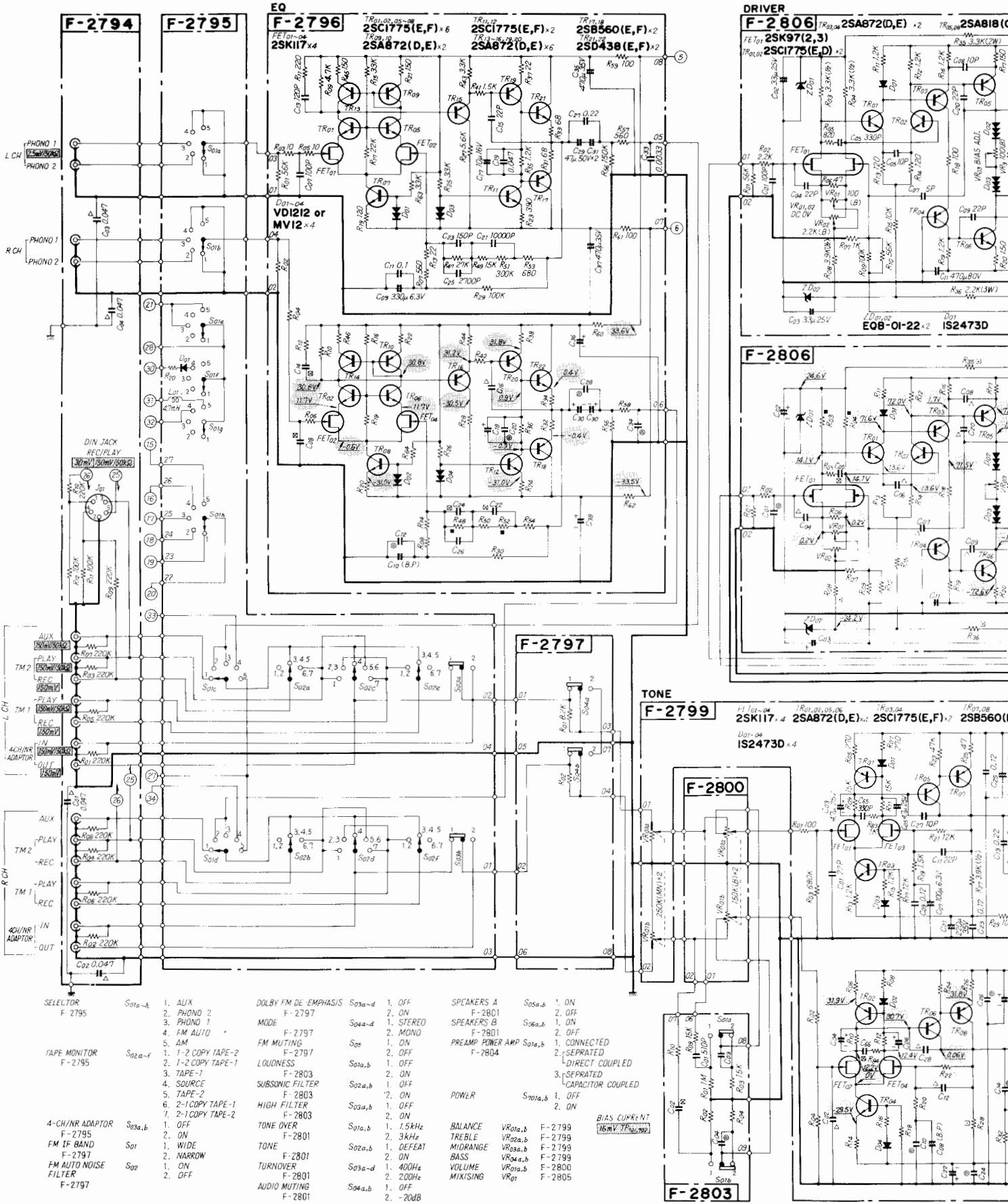

- |                                |        |   |
|--------------------------------|--------|---|
| SELECTOR<br>F-2795             | S01a-a | 1. AUX<br>2. PHONO 2<br>3. PHONO 1<br>4. FM AUTO<br>5. AM   |
| TAPE MONITOR<br>F-2795         | S02a-f | 1. 1-2 COPY TAPE-2<br>2. 1-2 COPY TAPE-1<br>3. TAPE-1<br>4. SOURCE<br>5. TAPE-2<br>6. 2-1 COPY TAPE-1<br>7. 2-1 COPY TAPE-2 |
| 4-CH/NR ADAPTOR<br>F-2795      | S03a,b | 1. OFF<br>2. ON   |
| FM IF BAND<br>F-2797           | S01    | 1. WIDE<br>2. NARROW  |
| FM AUTO NOISE FILTER<br>F-2797 | S02    | 1. ON<br>2. OFF   |
| DOLBY FM DE EMPHASIS<br>F-2797 | S03a-d | 1. OFF<br>2. ON   |
| MODE<br>F-2797                 | S04a-d | 1. STEREO<br>2. MONO  |
| FM MUTING<br>F-2797            | S05    | 1. ON<br>2. OFF   |
| LOUDNESS<br>F-2803             | S01a,b | 1. OFF<br>2. ON   |
| SUBSONIC FILTER<br>F-2803      | S02a,b | 1. OFF<br>2. ON   |
| HIGH FILTER<br>F-2803          | S03a,b | 1. OFF<br>2. ON   |
| TONE OVER<br>F-2801            | S01a,b | 1. 1.5kHz<br>2. 3kHz  |
| TONE<br>F-2801                 | S02a,b | 1. DEFEAT<br>2. ON  |
| TURNOVER<br>F-2801             | S03a-d | 1. 400Hz<br>2. 200Hz  |
| AUDIO MUTING<br>F-2801         | S04a,b | 1. OFF<br>2. -20dB  |
| SPEAKERS A<br>F-2801           | S05a,b | 1. ON<br>2. OFF   |
| SPEAKERS B<br>F-2801           | S06a,b | 1. ON<br>2. OFF   |
| PREAMP POWER AMP<br>F-2804     | S07a,b | 1. CONNECTED<br>2. SEPARATED<br>3. SEPARATED<br>CAPACITOR COUPLED   |
| POWER<br>F-2804                | S07a,b | 1. OFF<br>2. ON   |
| BALANCE<br>VR01a,b             | F-2799 |   |
| TREBLE<br>VR02a,b              | F-2799 |   |
| MIDRANGE<br>VR03a,b            | F-2799 |   |
| BASS<br>VR04a,b                | F-2799 |   |
| VOLUME<br>VR01a,b              | F-2800 |   |
| MIXING<br>VR01                 | F-2805 |   |

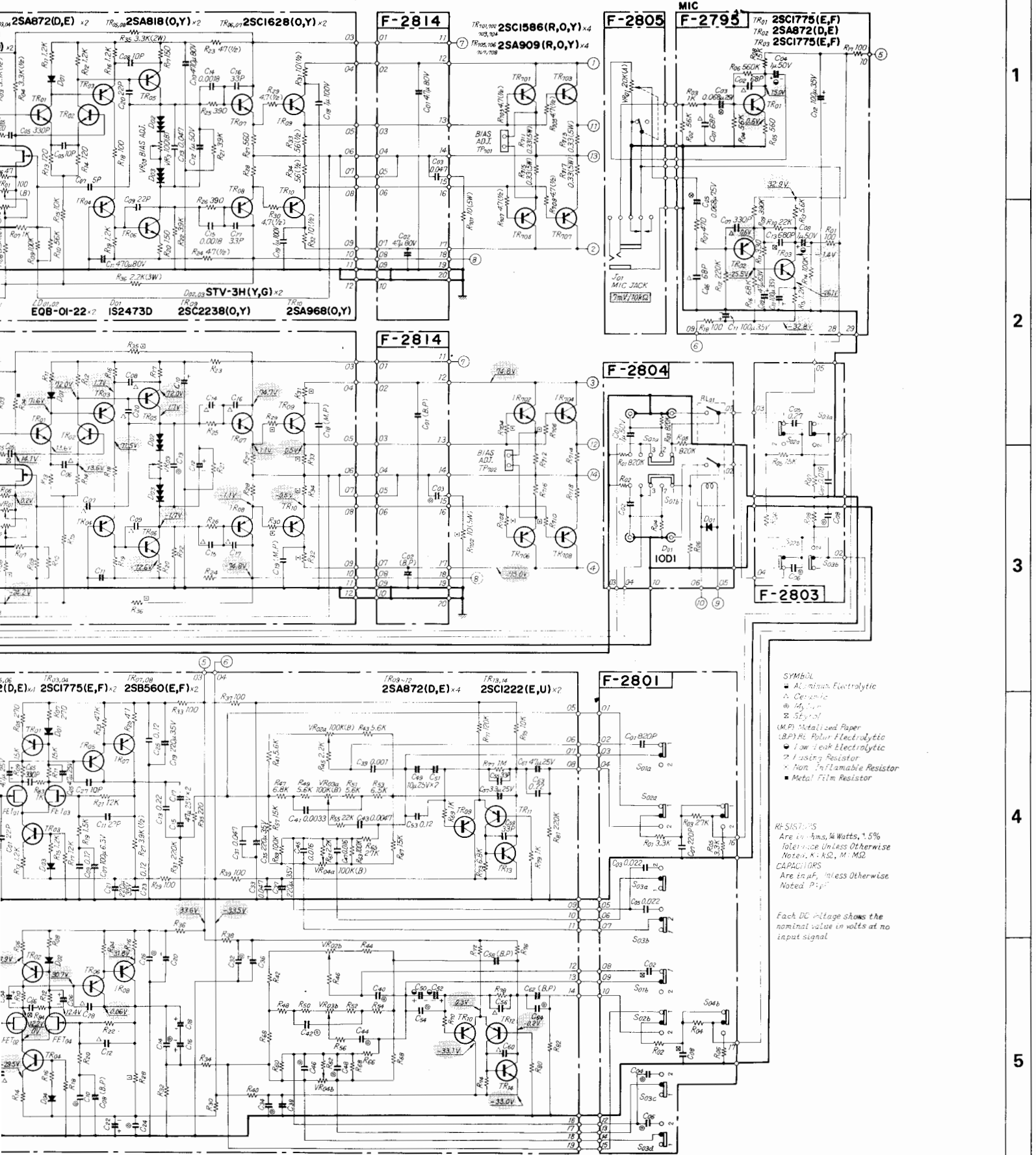

**SYMBOLS**  
 ■ Aluminum Electrolytic  
 ▲ Ceramic  
 ⊗ Mylar  
 ⊙ Styrol  
 (M.P.) Metallized Paper  
 (B.P.) Bi-Polar Electrolytic  
 ● Low Leak Electrolytic  
 ⊕ Fusing Resistor  
 ⊖ Non-Flammable Resistor  
 ■ Metal Film Resistor

**RESISTORS**  
 Are in Ohms, 1/4 Watts, 1.5% tolerance unless otherwise noted. K, KΩ, M, MΩ.  
**CAPACITORS**  
 Are in pF, unless otherwise noted. pF.

Each DC Voltage shows the nominal value in volts at no input signal.

1  
2  
3  
4  
5



A	B	C	D
---	---	---	---

### 6. «G-9000/901» Power Supply Section

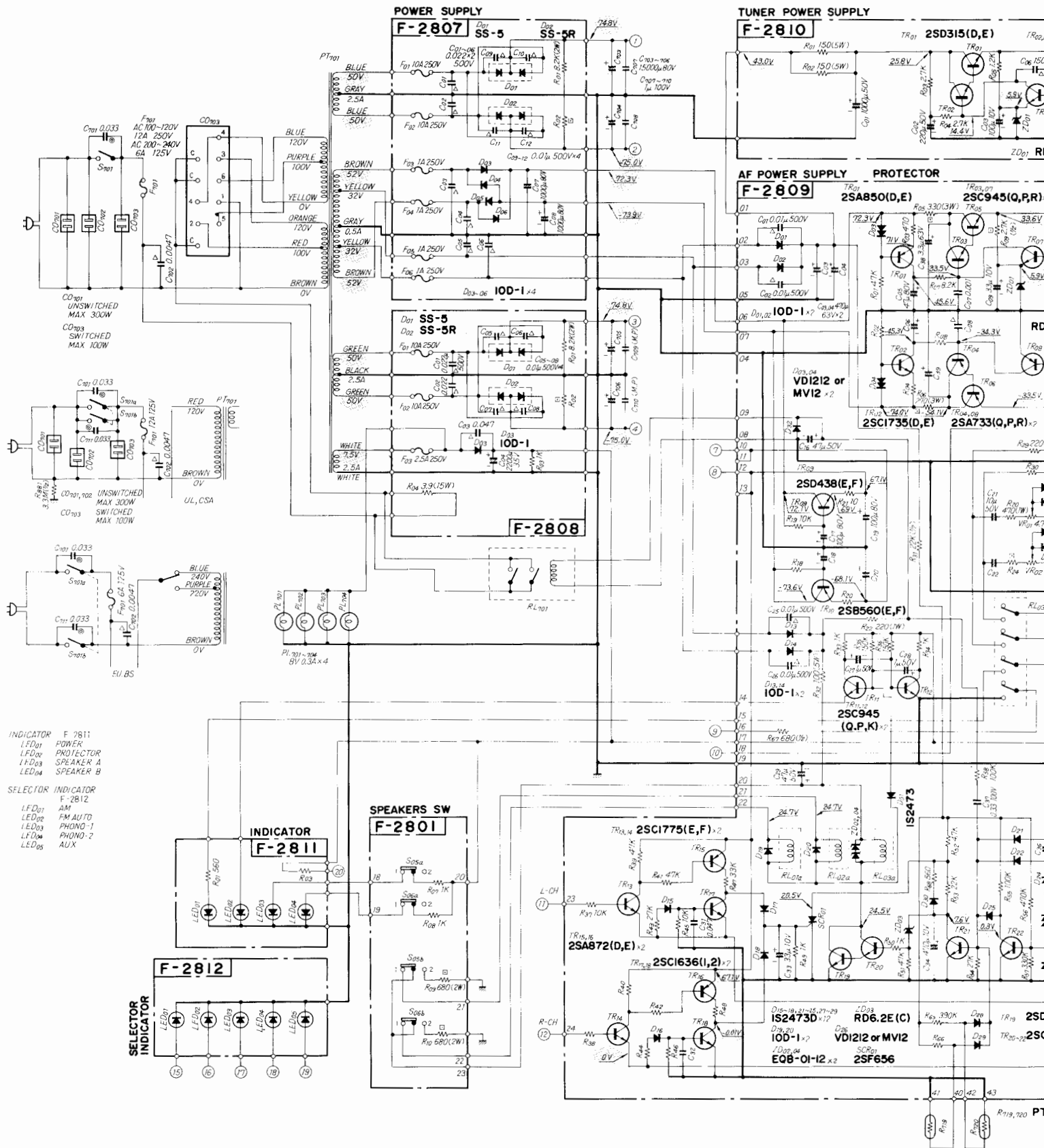

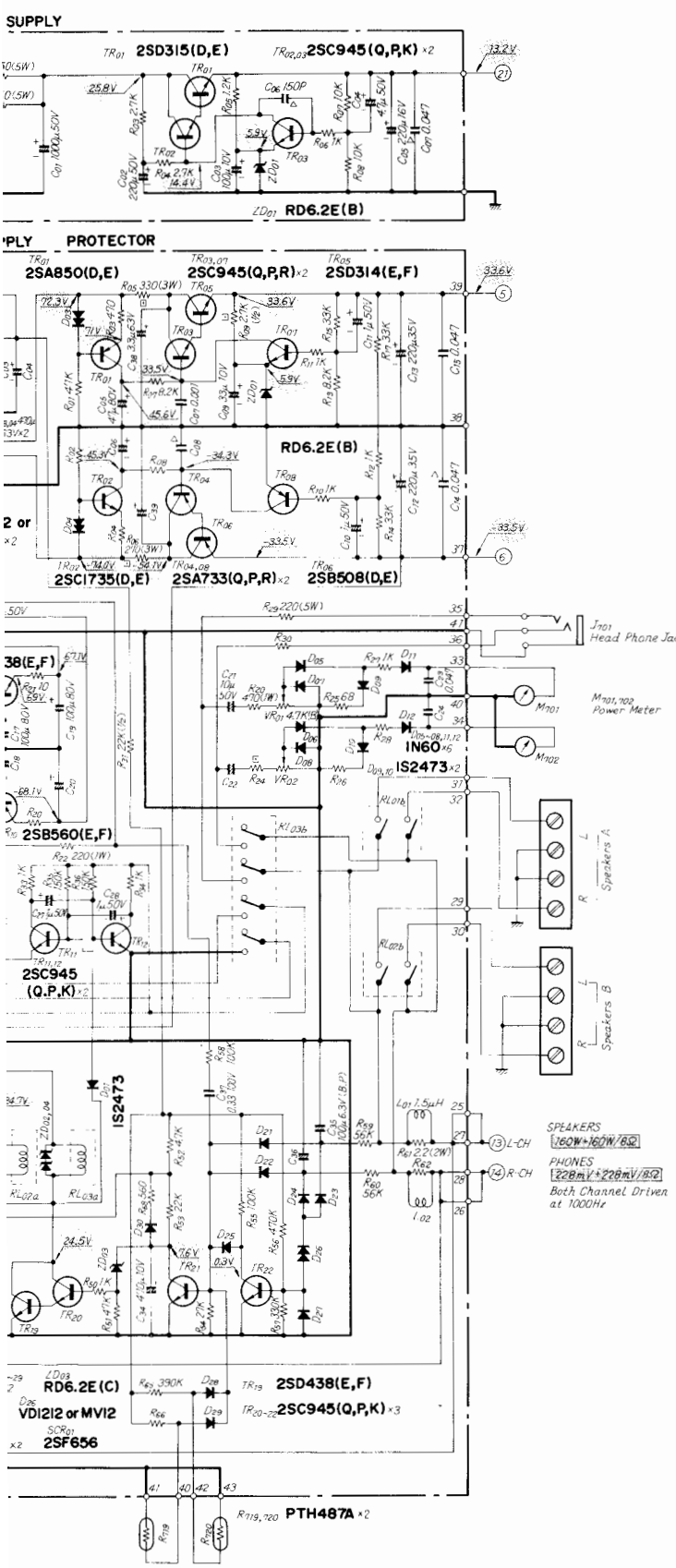

- |          |         |          |
|----------|---------|----------|
| 2SA872   | 2SA968  | 2SC1628  |
| 2SA733   | 2SB508  |          |
| 2SB560   | 2SC2238 |          |
| 2SC1775  | 2SD314  |          |
| 2SC945   |         |          |
| 2SC1222  |         |          |
| 2SC1674  |         |          |
| 2SC1634  |         |          |
| 2SD438   |         |          |
|          | 2SA909  | TA7302P  |
|          | 2SC1586 | μPC1163H |
|          | 2SD315  |          |
| 2SC1636  |         |          |
|          | 2SK97   | HA1137W  |
|          |         | HA1196   |
|          |         | HA1197   |
| 2SA726   |         |          |
| 2SA850   |         |          |
| 2SC711   |         |          |
| 2SC1735  |         |          |
| 2SC1313  |         |          |
|          | μPC577H |          |
|          |         | D873     |
|          |         | G35 911  |
| 2SK117   | VD1212  | 1S2473D  |
|          | MV12    | 1S1588   |
|          |         | 1N60P    |
| SS5      |         | 1S2226   |
|          |         | RD62E    |
| SS5R     |         |          |
|          |         | 10D1     |
| EQB01 22 | 2SF656  |          |
| EQB01-12 |         | STV3H    |

SPEAKERS  
[260W+160W/8Ω]

PHONES  
[220mV+220mV/8Ω]

Both Channel Driven at 1000Hz

1

2

3

4

5

# 7. THREADING OF DIAL CORD

\*If a dial cord is cut off or slips, replace it by following procedures.  
 As this unit uses 0.5 mmφ cord, please replace it with the same type certainly.  
 \*The length of dial cord is approximately 170cm (66.9 inch),

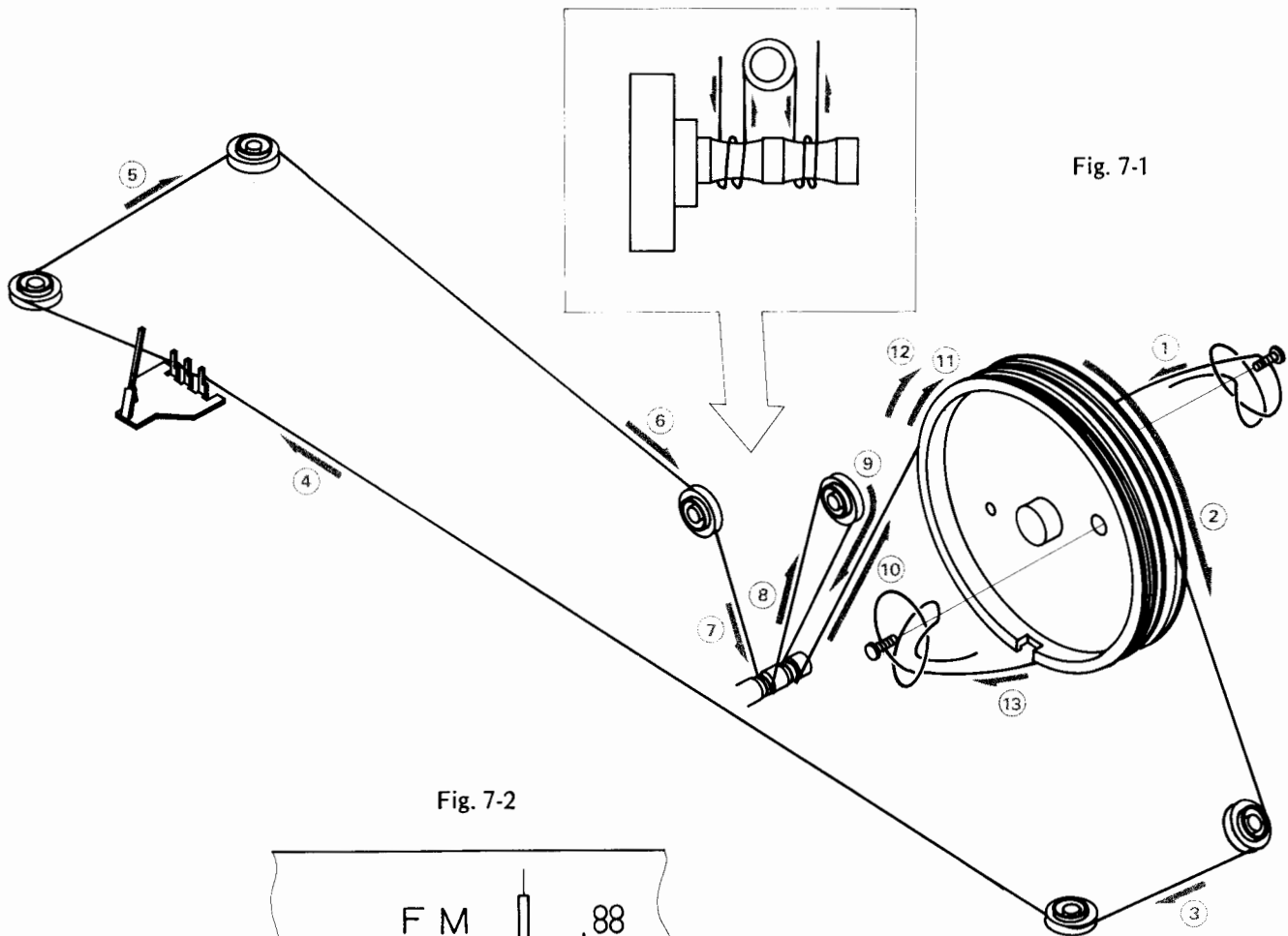

Fig. 7-1

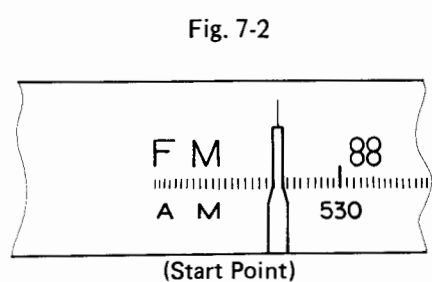

Fig. 7-2

### Threading of Dial Cord

Thread the dial cord in numerical order from 1 to 13 as Fig. 7-1.  
 \*Close the variable capacitor completely.

Stock No.	Description
6036050	Dial Cord (0.5 mmφ)
6146721	Dial pulley

### Attachment of Dial Pointer

- 1) Close the variable capacitor completely.
  - 2) Set the indication to the start point, the line at the left edge of the dial scale.
- \*Confirm that the dial pointer runs smoothly on the dial scale by turning the tuning shaft.

## 8. PACKING LIST

Parts No.	Stock No.	Description
1	9116740	Vinyl Cover
	9126270	Poryethylene Sheet
2	9028130	Stylofoam Packing (L-Upper)
3	9029120	Stylofoam Packing (R-Upper)
4	9028110	Stylofoam Packing (Lower)
5	9028160	Stylofoam Packing
6	9009901	Carton Case <<G-8000>>
	9000550	Carton Case <<G-801>>
	9009911	Carton Case <<G-9000>>
	9000540	Carton Case <<G-901>>
7	5996080	Curly Stopper

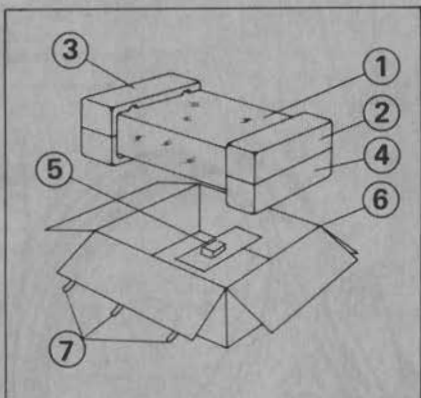

## 9. ACCESSORY PARTS LIST

Stock No.	Description
9202900	Operating Instructions <<G-8000>>
9203740	Operating Instructions <<G-801>>
9202890	Operating Instructions <<G-9000>>
9203750	Operating Instructions <<G-901>>
9237700	Schematic Diagram <<G-8000>>
9237800	Schematic Diagram <<G-801>>
9237710	Schematic Diagram <<G-9000>>
9237790	Schematic Diagram <<G-901>>
2410560	Short Pinplug 2Pcs.

MEMO

**Sansui**

SANSUI ELECTRONICS CORPORATION: 55-11 Queens Blvd. Woodside, N.Y. 11377 U.S.A.  
333 West Alondra Blvd. Gardena, California 90247 U.S.A.  
3036 Koapaka St. Honolulu, Hawaii 96819 U.S.A.

SANSUI AUDIO EUROPE N.V.: North Trade Bldg (9th floor) Noorderlaan 133-Bus 1,2030 Antwerp, Belgium  
SANSUI AUDIO EUROPE S.A.: Arabella center, 6 Frankfurt AM Main, Lyoner Strasse 44-48, West Germany

SANSUI ELECTRIC COMPANY LTD.: 14-1, Izumi 2-chome, Suginamiku, Tokyo 168 Japan PHONE: (03) 323-1111. TELEX:232-2076