

SERVICE MANUAL

STEREO CASSETTE DECK

SANSUI SC-1300/1330

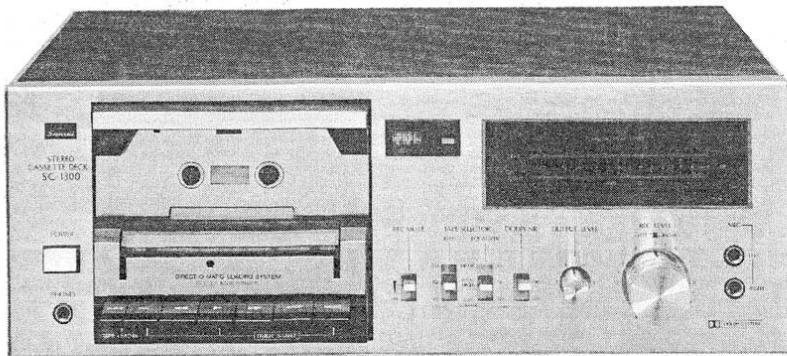

SPECIFICATIONS

Track	4-Track (2-Channel Stereo)
Tape Speed	4.8 cm/sec. (1-7/8 ips)
Heads	Record/Playback: FH Head Erase: Double Gap Ferrite Head
Motor	Electronically Controlled DC Motor
Wow and flutter	within 0.05 % WRMS
Fast wind time	approximately 75 seconds (C-60)
Frequency response (Record/Playback)	
Normal Tape (LH) (-20 VU)	
.....	20 to 16,000 Hz (20 to 15,000 Hz \pm 3 dB)
Metal Tape (-20 VU)	
.....	20 to 18,000 Hz (20 to 16,000 Hz \pm 3 dB) (0 VU) . 20 to 13,000 Hz \pm 3 dB
Signal to noise ratio (Record/Playback)	
Metal Tape (without Dolby Noise Reduction Effect)	
.....	better than 59 dB (weighted)
(With Dolby Noise Reduction)	
.....	better than 69 dB (above 5 kHz)
Erasure factor	
Metal Tape	more than 70 dB at 1,000 Hz
Input sensitivity and impedance (0 VU, 1,000 Hz)	
MIC	0.3 mV/200 Ω ~ 5 k Ω
LINE IN (REC)	70 mV/100 k Ω
Output level (0 VU, 1,000 Hz)	
LINE OUT (PLAY)	
.....	390 mV
PHONES	65 mV/8 Ω
Bias frequency	85 kHz
Power requirements	
Power voltage	100, 120, 220, 240 V (50/60 Hz)
For U.S.A. and Canada	
.....	120 V (60 Hz)
Power consumption	
.....	12 W (rated)
Dimensions	433 mm (17-1/16") W <SC-1300> 430 mm (16-15/16") W <SC-1330> 482 mm (19") W <SC-1330> (with Rackmounting Adaptor) 160 mm (6-5/16") H 320 mm (12-5/8") D
Weight	5.9 kg (13.0 lbs.) net <SC-1300> 7 kg (15.4 lbs.) packed <SC-1300> 6.85 kg (15.1 lbs.) net <SC-1330> 8.0 kg (17.6 lbs.) packed <SC-1330>

*Design and specifications subject to changes without notice for improvements.



SANSUI ELECTRIC CO., LTD.

1. BLOCK DIAGRAM

1-1. Playback Operation

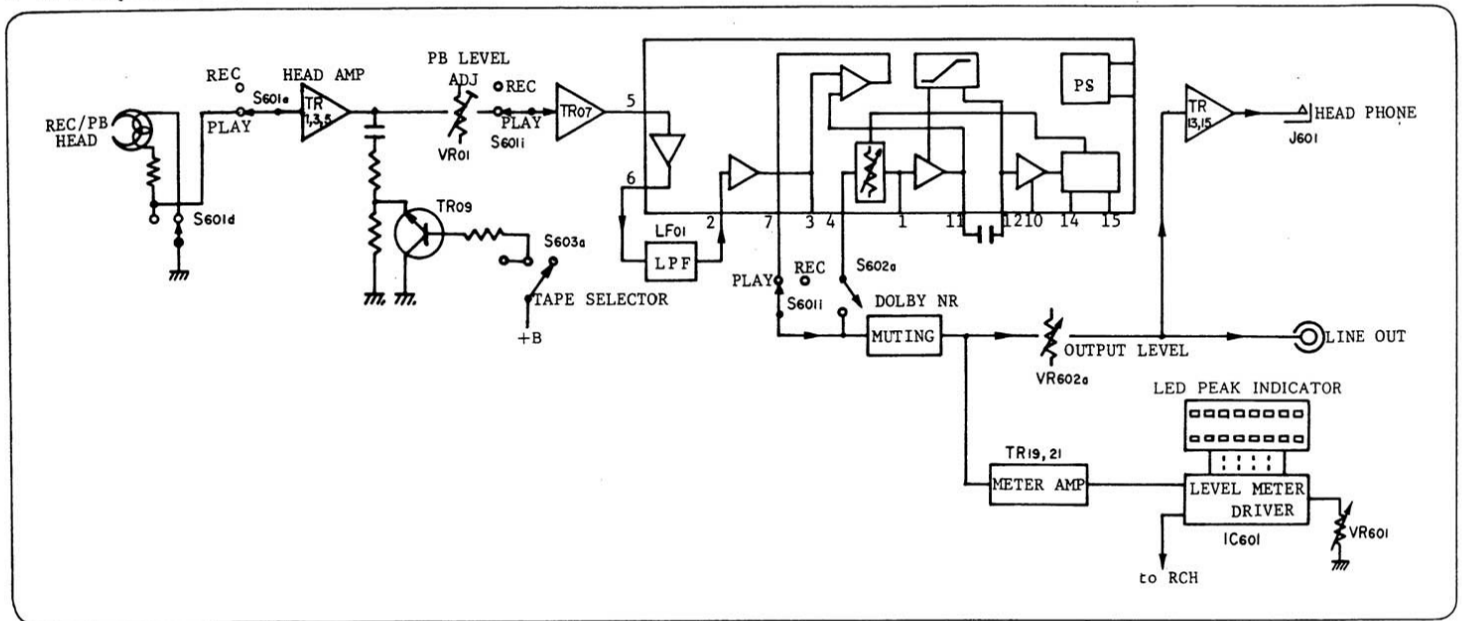

1-2. Recording Operation

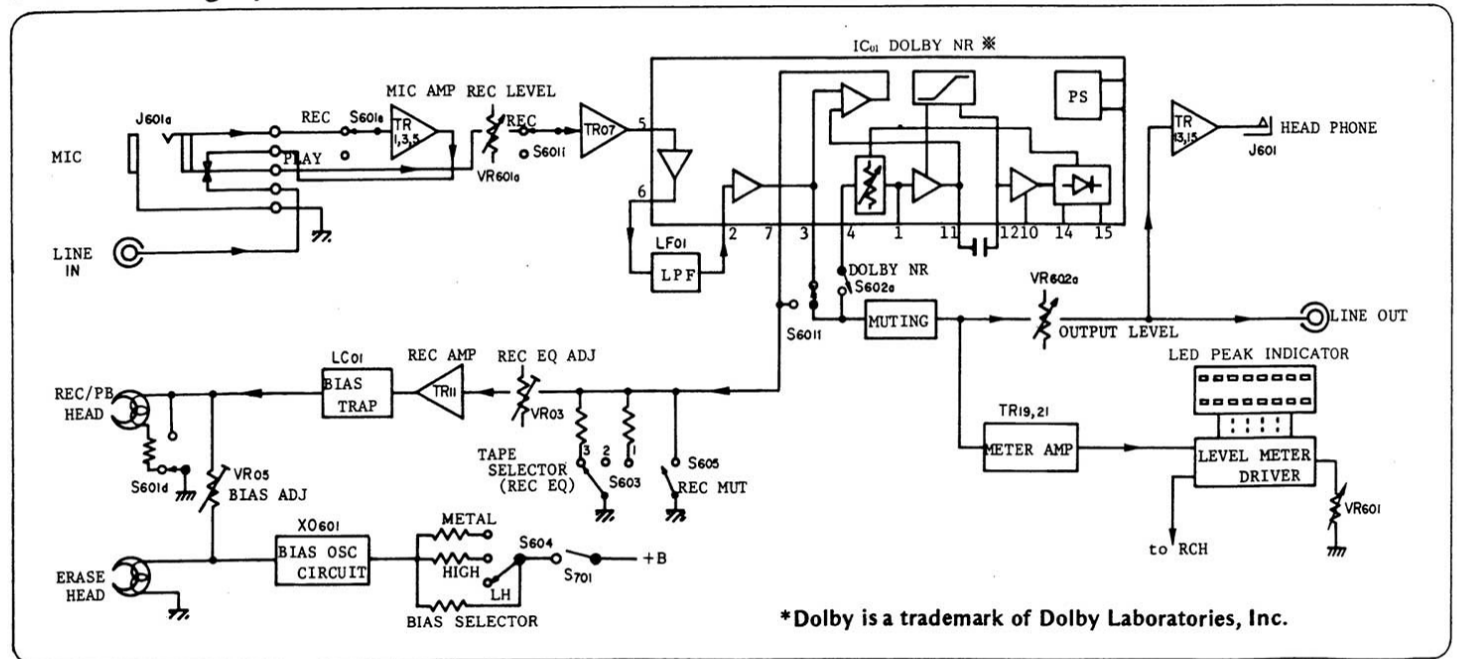

*Dolby is a trademark of Dolby Laboratories, Inc.

2. ADJUSTMENTS

1. Tape Speed Adjustment

- Note: 1. Use Sansui Test Tape, SCT-S3K (3 kHz signals are recorded on the tape).
2. Connections are shown in Fig. 2-1.

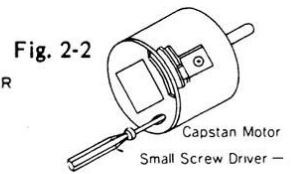
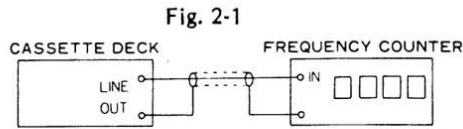

STEP	SUBJECT	INPUT SIGNAL	CHECK POINT	SETTING	ADJUST	ADJUST FOR	REMARKS
1.	TAPE SPEED ADJ.	Test Tape SCT-S3K	LINE OUT	Depress the PLAY button and playback the Test Tape, SCT-S3K	If not, turn semi-variable resistor as Fig. 2-2 until 3000 Hz \pm 45 Hz is obtained.	3000 Hz \pm 45 Hz	Use small screw driver.

2. Playback Adjustment

- Note: 1. Before this adjustment, clean REC/P.B head surface.
2. Set the output level volume to be maximum.
3. For this adjustment, use Sansui Test Tape, SCT-F10KN, SCT-L400N and SCT-F1K.
4. Set the Dolby switch to be OFF.
5. Connections are shown in Fig. 2-3.

Note: Azimuth adjustment can be carried out from front side without removing head cover (See Fig. 8-1 on page 11)

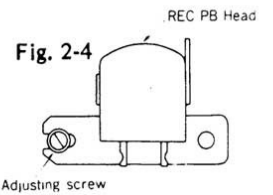
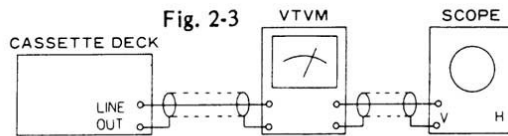

STEP	SUBJECT	INPUT SIGNAL	CHECK POINT	SETTING	ADJUST FOR	REMARKS
1.	REC/PB Head Adj.	SCT-F10KN	LINE OUT VTVM Scope	Depress the PLAY button and play back the Test Tape, SCT-F10KN.	Adjust the azimuth adjusting screw in Fig. 2-4 for the maximum reading on the VTVM on both channels.	After this adjustment, lock the screw with paint.
2.	Playback Level Adj.	SCT-L400N	Same as above	Set EQ SELECTOR to NORMAL (LH) position. Depress the PLAY button and play back the Test Tape, SCT-L400N.	Adjust VR01 for L-CH and VR02 for R-CH for the reading of 500 mV on VTVM. See Top View on page 6	Set same level 500 mV \pm 2 dB on both channels.
3.	High Frequency Equalization Check	SCT-F1K and SCT-F10KN	Same as above	Set EQ SELECTOR to NORMAL (LH) position. Depress the PLAY button and play back the Test Tape, SCT-F1K and SCT-F10KN.	Confirm that the difference of output levels between SCT-F1K and SCT-F10KN is within \pm 3 dB.	In playback of SCT-10KN, set the EQ SELECTOR to HIGH (CrO ₂) position, then confirm the indication on VTVM drops approximately 3 dB ~ 4 dB.

3. Recording Adjustment

1) Bias Adjustment

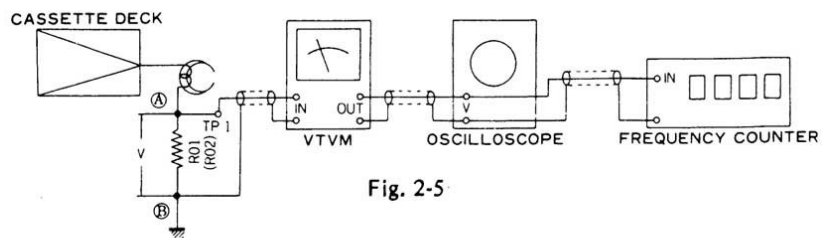

STEP	SUBJECT	INPUT SIGNAL	CHECK POINT	SETTING	ADJUST	REMARKS
1.	Recording Bias Adj.	SCT-SA	Voltage value between A and B of R01 & R02 (See Top View on page 6)	Depress REC, PLAY and PAUSE buttons. Set BIAS SELECTOR to HIGH (CrO ₂) position.	Adjust VR05 for L-CH and VR06 for R-CH for the reading of 6.0 mV between A and B in Fig. 2-5 on both channel.	VR05, VR06 See Top View on page 6.
				Set BIAS SELECTOR to NORMAL (LH) position.	Confirm the indication on VTVM shows 4.6 mV.	
				Set BIAS SELECTOR to Metal position.	Confirm the indication on VTVM shows 9.2 mV.	
2.	Bias Frequency Check	Same as above	Same as above	Set BIAS SELECTOR to NORMAL position.	Confirm that frequency counter shows 85 kHz \pm 10 kHz.	

2) Rec Level & Frequency Response Adjustment

- Note: 1. Output Level Volume Maximum.
2. Connections are shown in Fig. 2-6.

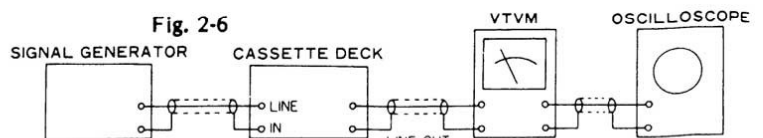

to be continued ►

STEP	SUBJECT	INPUT SIGNAL	CHECK POINT	SETTING	ADJUST FOR	REMARKS
1.	REC Level Adj.	Use recording HIGH (CrO ₂) tape SCT-SA Feed 1 kHz, 70 mV (-20 dB) from S.G into LINE IN.	LINE OUT VTVM Scope	Set BIAS & EQ SELECTOR to HIGH (CrO ₂) position. 1. Depress PAUSE, PLAY and REC button. 2. Adjust the Rec Level Volume for obtaining 300 mV on VTVM. 3. Push off the PAUSE button, then record the 1 kHz signal. 4. Play back the 1 kHz signal. 5. Confirm that the output levels on both channels are 300 mV ± 2 dB on VTVM.	1. If not, turn VR03 for L-CH and VR04 for R-CH until output level 300 mV ± 2 dB on both channel are obtained. 2. Repeat this REC Level adj. until the indication on VTVM will be 300 mV ± 2 dB.	VR03, VR04 (G-1242) See Top View on page 6
2.	Frequency Response Adj.	Feed 1 kHz 7 mV (-20 dB) and 10 kHz 7 mV (-20 dB) from S.G. into LINE IN.	LINE OUT	Set BIAS & EQ SELECTOR to HIGH (CrO ₂) position. 1. Record the 1 kHz and 10 kHz signals from S.G. 2. Play back the 1 kHz and 10 kHz signals, then confirm that the difference of output levels between 1 kHz and 10 kHz are within 0 dB against that of 1 kHz.	1. If not, adjust VR05 for L-CH and VR06 for R-CH slightly until difference of output levels between 1 kHz and 10 kHz recorded are within 0 dB against that of 1 kHz.	As VR05 and VR06 are previously adjusted in step of Bias Adjustment, turn them slightly, if necessary.

4. Peak Level Meter Adjust

Note: Output Level Volume Max.

STEP	SUBJECT	INPUT SIGNAL	CHECK POINT	SETTING	ADJUST FOR	REMARKS
1.	Peak Level Meter Adj.	Feed 1 kHz 110 mV from S.G. into LINE IN SCT-SA	LINE OUT VTVM	1. Depress PAUSE, PLAY and REC button. 2. Adjust the Rec Level Volume for obtaining 470 mV on VTVM.	1. Light 0 dB indication of peak meter to adjust VR601 (L-CH) on G-1265. 2. Indication of 0 dB turns off when decreasing output level 0.2 dB from 470 mV by recording level volume.	Adjust VR601 (L-CH) on G-1265 at first then perform VR603 (R-CH) on G-1242. See Top View on page 6
2.	Filter 19 kHz 85 kHz Adj.	Feed 19 kHz 110 mV and 85 kHz 110 mV from S.G. into LINE IN.	LINE OUT VTVM	Depress PAUSE PLAY and REC button.	Make the output minimum to adjust white core (19 kHz) and black core (85 kHz) of LF01 (L-CH) and LF02 (R-CH)	LF01, LF02 (G-1242) See Top View on page 6

◇ Tape Selector Position

Tape Selector		REC	PLAY
		Bias/Equalizer	Equalizer
FUJI	Super Range	metal	metal
MAXELL	MX		
TDK	MA-R		
SCOTCH	Metafine		
SONY	METALLIC		
FUJI	Range 4X	high(CrO ₂)	high(CrO ₂)
MAXELL	XL II		
TDK	SA		
SCOTCH	MASTER 70		
SONY	JHF		
BASF	SCR		

Tape Selector		REC	PLAY
		Bias/Equalizer	Equalizer
SONY	Duad	normal(LH)	high(CrO ₂)
BASF	FCR		
FUJI	Range-2	normal(LH)	normal(LH)
	Range-4		
	Range-6		
MAXELL	UL		
	UD		
	XL I		
TDK	D		
	AD		
	OD		

Tape Selector		REC	PLAY
		Bias/Equalizer	Equalizer
SCOTCH	TARTAN	normal(LH)	normal(LH)
	CRYSTAL		
	MASTER 120		
SONY	AHF		
	BHF		
	CHF		
	Low-Noise		
BASF	LN	normal(LH)	normal(LH)
	Super LH I		

◇ List of Sansui Test Tape

Name of test tape	Recorded Frequency	Description	Name of test tape	Recorded Frequency	Description
SCT-S3K	3KHz	Speed check, Wow & Flutter check	SCT-SA<HIGH(CrO ₂)>		Recording Bias Adjustment
SCT-L400N	400Hz	Playback level and VU meter level adjustment	SCT-LH<NORMAL(LH)>		REC/PB Level Adjustment
SCT-F1K	1KHz	High frequency equalization check	SCT-CS(Fe-Cr)		Frequency response check
SCT-F10KN	10KHz	REC/PB head adjustment	SCT-F40	40Hz	Playback Frequency response check

3. PARTS LOCATION & PARTS LIST

3-1. G-1242 Main Circuit Board (Stock No. 76201601)

• Since some of capacitors and resistors are omitted from parts lists in this Service Manual, refer to the new Common Parts List for capacitors & resistors.

• As the stock number in the parts list on this service manual is indicated in 8 digit to differ from ordinary 7 digit, please be careful when ordering parts.

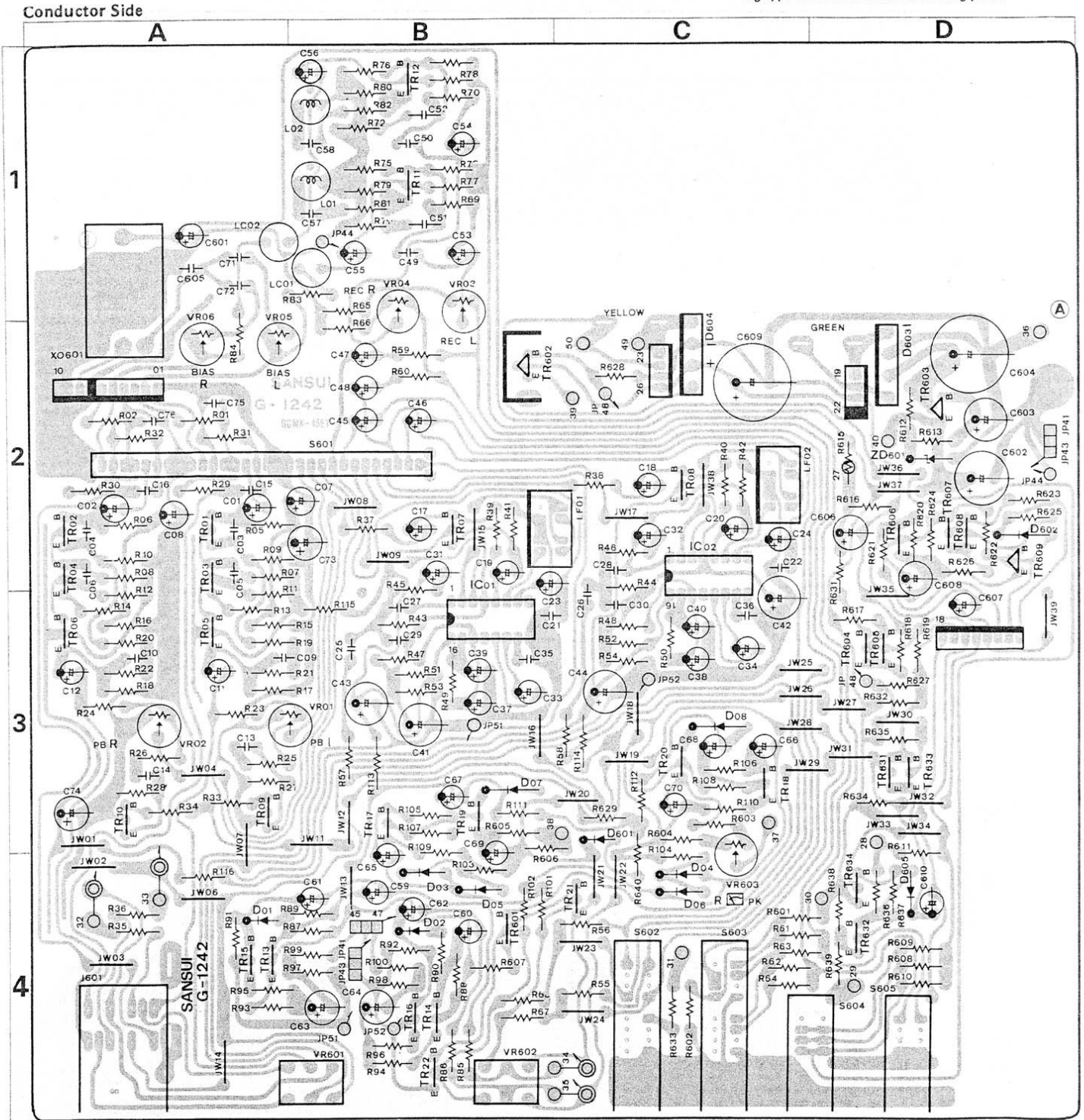

Parts List

Parts No.	Stock No.	Description	Position	Parts No.	Stock No.	Description	Position	Parts No.	Stock No.	Description	Position
• Transistor											
TR01 ~ 08	03060701, 2	2SC1313 G, H	2A, B, C	D 603	03117000	RB-152	2D	VR05, 06	10351900	100kΩ (B), Bias Volume	2A
TR09 ~ 14	03068301, 2	2SC2320 E, F	1B, 4A	D 604	03117000	RB-152	2C	VR601	10250400, 1	50kΩ (A) x 2, Rec Level Volume	4B
TR15, 16	03012700, 1	2SA999 E, F	4A, B	• Zener Diode							
TR17 ~ 22	03068301, 2	2SC2320 E, F	3, 4B, C	ZD601	03179200	RD15E B	2D	VR602	10156400, 1	10kΩ x 2, Output Level Volume	4B
TR601	03012700, 1	2SA999 E, F	4B	• LED							
TR602, 603	03083901, 2	2SD313AL D, E	2B, D	LED601	03193200	GL-9NG9		VR603	10352100	220kΩ (B) x 2, Meter R Level Volume	4C
TR604 ~ 08	03068301, 2	2SC2320 E, F	2D, 3D	• IC							
TR609	03083901, 2	2SD313AL D, E	2D	IC 01, 02	03613600	NE646B	2C, 3B	• Diode			
• IC											
IC 01, 02	03613600	NE646B	2C, 3B	D 01, 02	03401500	MV-12	4A, B	S 601	11104000	Rec/Play Switch	2A
• Diode											
D 01, 02	03401500	MV-12	4A, B	D 03 ~ 06	03117600	1S2473D	4B, C	S 602	11721100	Dolby NR Switch	4C
D 03 ~ 06	03117600	1S2473D	4B, C	D 07, 08	03117800	1N60	3B, C	S 603	11721200	Tape Selector Switch (EQ)	4C
D 07, 08	03117800	1N60	3B, C	D 601	03401500	MV-12	3C	S 604	11721000	Tape Selector Switch (Bias)	4C
D 601	03401500	MV-12	3C	D 602	03117700	10E-2	2D	S 605	11720900	Rec Muting Switch	4D
D 602	03117700	10E-2	2D	• Inductor							
• Inductor											
L 01, 02	49005500	3.9 mH Inductor	1B	LC01, 02	42904400	Trap Coil	1A, B	J 601	24305300	Mic Jack	4A
LC01, 02	42904400	Trap Coil	1A, B	LF01, 02	09106300	BL-30HA, Low Pass Filter	2B, C	XO601	08250400	OSC Composit Parts	1A
LF01, 02	09106300	BL-30HA, Low Pass Filter	2B, C	• Resistor							
• Resistor											
VR01, 02	10351700	47kΩ (B), Play Level Volume	3A	• Capacitor							
VR03, 04	10351300	10kΩ (B), Rec Level Volume	1B	• Capacitor							
• Capacitor											

3-2. G-1265 Peak Meter Circuit Board (Stock No. 76907301)

Conductor Side

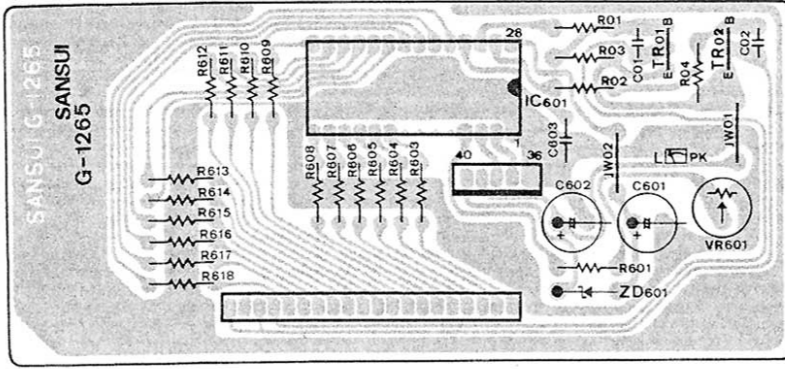

Parts List

Parts No.	Stock No.	Description
•Transistor		
TR01, 02	03002200, 1	2SA562 O, Y
•IC		
IC 601	03613400	MSA806
•Zener Diode		
ZD601	03182800	RD3.9E-B
	03194100	SEL8809, LED Indicator Unit

•Abbreviations

C.R.	Carbon Resistor	E.L.	Low Leak Electrolytic Capacitor
S.R.	Solid Resistor	E.B.	Bi-Polar Electrolytic Capacitor
Ce.R.	Cement Resistor	E.BL.	Low Leak Bi-Polar Electrolytic Capacitor
M.R.	Metal Film Resistor	Ta.C.	Tantalum Capacitor
F.R.	Fusing Resistor	F.C.	Film Capacitor
N.I.R.	Non-Inflammable Resistor	M.P.	Metalized Paper Capacitor
C.C.	Ceramic Capacitor	P.C.	Polystyrene Capacitor
C.T.	Ceramic Capacitor, Temperature Compensation	G.C.	Gimmick Capacitor
E.C.	Electrolytic Capacitor		

4. OTHER PARTS

4-1. Front View

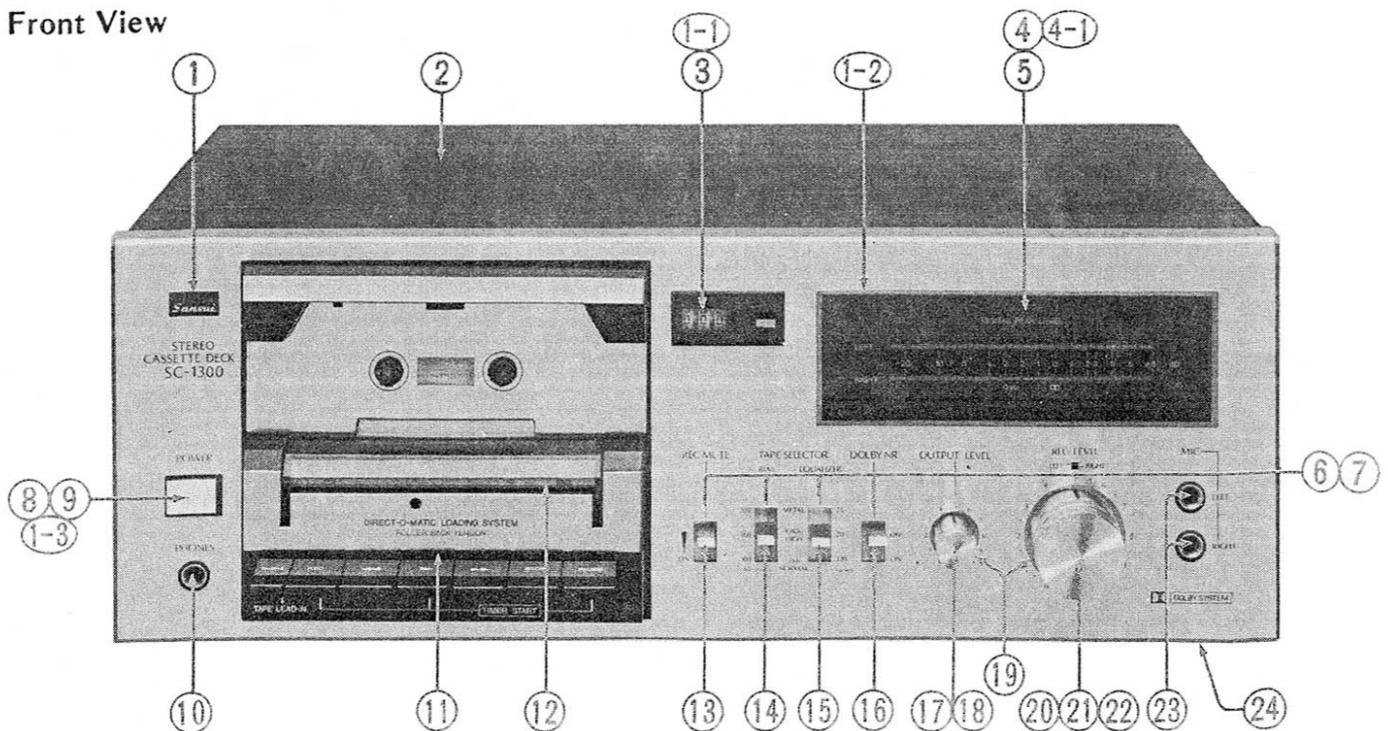

4-2. Top View

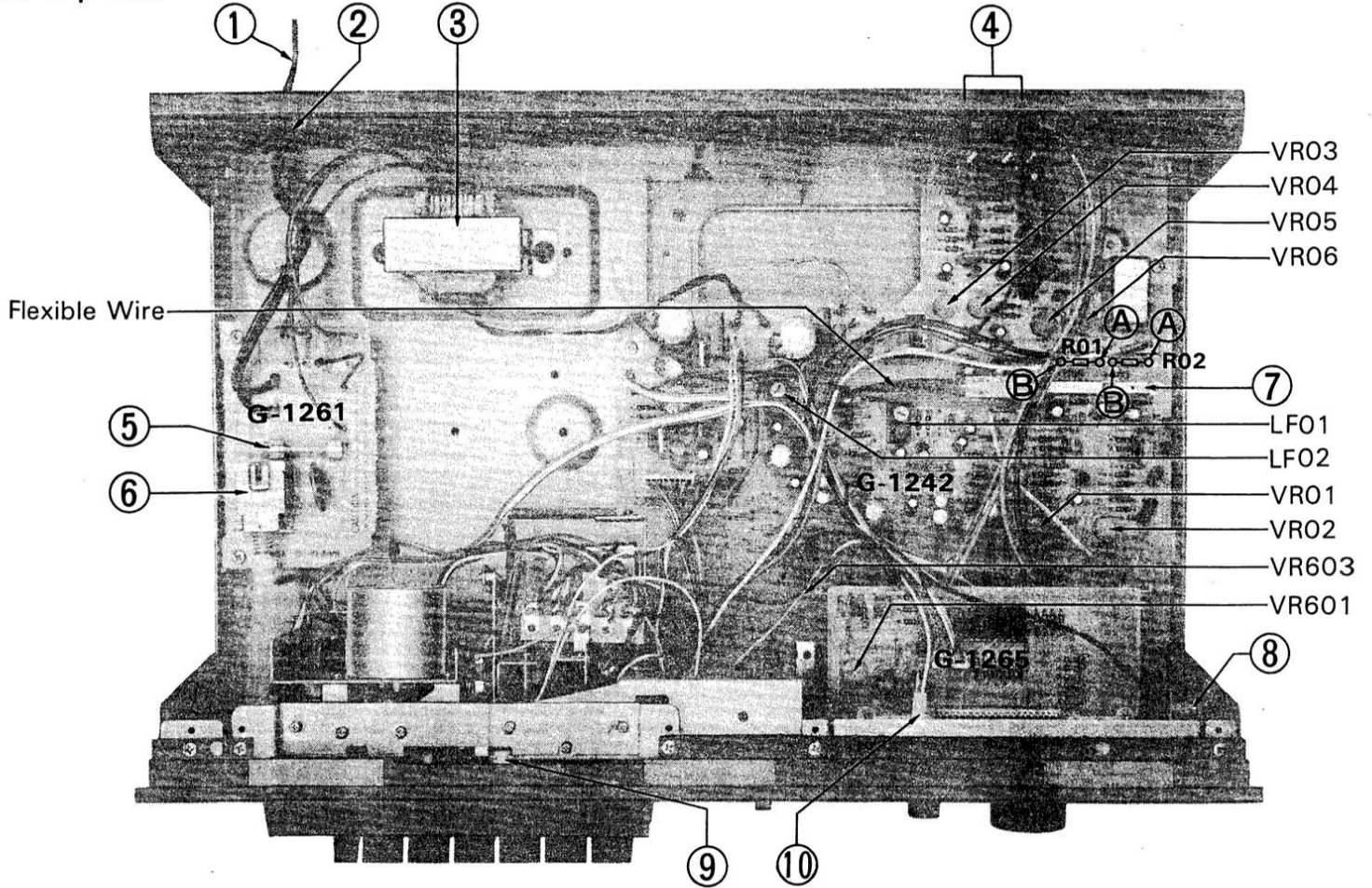

Parts List <Top View>

Parts No.	Stock No.	Description
1	38004700	Power Cord
2	39106000	Strain Relief
3	40032600	Power Transformer
4	22005800	4P Line In/Out Terminal
5	04322100	Power Fuse 0.5A 250V
6	11312300	Power Switch

Parts No.	Stock No.	Description
7	11104000	Rec/Play Switch
8	04007400	Peak Level Lamp
9	04008200	Lamp, cassette half
10	03193200	LED (Red), rec
	60560400	Flexible Wire

Parts List <Front View>

Parts No.	Stock No.	Description
1	{ 70003830 70003620	Front Panel Ass'y <SC-1300> Front Panel Ass'y <SC-1330>
1-1	{ 54400900	Counter Lens
1-2	{ 52605400	Front Meter Glass
1-3	{ 52813900	Knob Guide
2	{ 57402710 50000910	Wood Bonnet <SC-1300> Bonnet <SC-1330>
3	54301500	Tape Counter Ass'y
4	54505510	Peak Meter Window Ass'y
4-1	53505700	Scale Glass
5	54401310	Smoked Plate
6	{ 55102320 55102220	Masking Sheet <SC-1300> Masking Sheet <SC-1330>
7	{ 53206210 53206110	Knob <SC-1300> Knob <SC-1330>
8	{ 71000910 71000800	Power Switch Knob <SC-1300> Power Switch Knob <SC-1330>
9	11312300	Power Switch
10	24305400	Head Phone Jack

Parts No.	Stock No.	Description
11	{ 70004110 70004210	Mechanism Cover Ass'y <SC-1300> Mechanism Cover Ass'y <SC-1330>
12	50502700	Head Cover
13	11720900	Rec Mute Switch
14	11721200	Tape Selector Bias Switch
15	11721000	Tape Selector Equalizer Switch
16	11721100	Dolby NR Switch
17	{ 53106410 53105200	Output Volume Knob <SC-1300> Output Volume Knob <SC-1330>
18	10156400	10kΩ (B) x 2 Output Volume
19	{ 55102700 55102800	Masking Sheet <SC-1300> Masking Sheet <SC-1330>
20	{ 53106220 53105300	Left Rec Volume Knob <SC-1300> Left Rec Volume Knob <SC-1330>
21	{ 53106310 53105400	Right Rec Volume Knob <SC-1300> Right Rec Volume Knob <SC-1330>
22	10250400	50kΩ (A) x 2 Rec Volume
23	24305300	Mic Jack
24	55073500	Leg

5. EXPLODED VIEW AND PARTS LIST

Parts List <Exploded View>

Parts No.	Stock No.	Description	Parts No.	Stock No.	Description
103	70603400	Pinch Roller Arm Ass'y	217	51213200	Spring Washer, M2.6
104	71501400	Reel Hub (A) Ass'y	218	08322500	E Ring, M1.5 x 0.4
105	71501500	Reel Hub (B) Ass'y	219	51510040	E Ring, M3 x 0.6
106	70402300	Flywheel Ass'y	220	51510050	E Ring, M4 x 0.6
107	70603500	TU Idler Ass'y	221	51510020	E Ring, M2 x 0.4
109	70603600	FR Lever Ass'y	222	08322600	E Ring, M2.5 x 0.4
111	70603700	Idler (A) Ass'y	223	51201410	Plain Washer, M3.3 x 0.25
113	70603800	Idler (B) Ass'y	224	08323300	Plain Washer, M5.1 x 0.2
118	65010900	Upper Nail, cassette holder	225	08322400	Plain Washer, M2.6 x 0.5
119	65011000	Rec Prevention Nail	226	08323200	Plain Washer, M2.7 x 0.5
121	70603300	Counter Idler Ass'y	227	08322400	Plain Washer, M2.6 x 0.5
122	70501700	Play Button	228	51804400	Thrust Washer, M2.6 x 0.25
123	70501600	REW Button	229	51804200	Thrust Washer, M1.6 x 0.25
124	70501800	REC Button	230	51804300	Thrust Washer, M2.1 x 0.25
125	70501900	Stop Button	231	08323100	Plain Washer, M4.1 x 0.5
126	70502000	FF Button	232	08323500	Nylon Washer, M2.4 x 0.5
127	70502200	Pause Button			
128	70502100	TL Button	●Spring		
135	71602500	BT Idler Lever Ass'y	301	69011000	Head Adjust
142	61401700	BT Idler	302	69018600	Pinch Roller
152	61402000	Motor Pulley	303	69018700	TU Lever Ass'y
153	60302500	Capstan Belt	304	69018800	FR Lever Ass'y
154	60302600	Counter Belt (A)	305	69018900	Idler Lever
155	60302400	Counter Belt (B)	306	69019000	Idler (B) Lever
159	56000200	Lamp Holder	307	69019100	Play Plunger Rest
160	51604000	Flywheel Thrust Screw	308	69019300	Head Base
161	53700900	Cap	309	69019400	Cassette Holder
169	65011400	Right Nail	310	69019500	Rec Prevention Nail
170	65011500	Left Nail	311	69019600	Brake Lever
178	54301500	Counter	312	69019700	Brake Lever Plate
			313	69019800	Pause Lock Plate
●Washers, Nuts, Screws			314	69019900	Push Button Lock Plate
201	51102210	Hexagon Nuts, M2.6	315	69020000	Rec Stopper Lever
202	08322300	Slot Type Set Screw, M2 x 3	316	69018300	TL Button Lever
203	08321100	Pan Head Tapping Screw, M2.6 x 8	317	69018400	Pause Button Lever
204	51035020	Pan Head Tapping Screw, M2 x 6	318	69018500	FF Button Lever
205	51099110	Binding Head Tapitite Screw, M3 x 6	319	69020100	Nail
206	08321300	Pan Head SEMS (A type) Screw, M2.6 x 4	320	69020200	Connecting Lever
207	08321400	Pan Head SEMS (A type) Screw, M2.6 x 6	321	69020300	Over Stroke
208	08322100	Pan Head SEMS (A type) Screw, M3 x 6	322	69020400	Over Stroke Lever
209	08322800	Pan Head SEMS (A type) Screw, M2.6 x 7	323	07527200	Rec Lever
210	51030420	Pan Head Screw, M3 x 5			
211	08322200	Pan Head Screw, M2.6 x 10	401	04008200	Lamp
212	08321600	Pan Head SEMS (A type), M2 x 6	402	43402900	Solenoid
213	08321800	Pan Head SEMS (A type), M2 x 5	403	11908000	Leaf Switch
214	08321500	Pan Head SEMS (A type), M2 x 5	404	11908100	Leaf Switch
215	08321900	Pan Head Screw, M2 x 8	405	11908200	Leaf Switch
216	08321700	Pan Head SEMS (A type), M3 x 10	406	11908300	Leaf Switch
			408	43207500	Capstan Motor
			409	45360600	REC/P.B Head
			410	45260400	Erase Head
			412	03614000	Holl IC DN6838 (Reed Switch)

*Though every part included in mechanism ass'y is numbered in exploded view, parts unlisted in the parts list are not supplied.

Abbreviations

1. Pan Head Tapping Screw ... PT Type	3. Pan Head Screw ... P Type	5. Pan Head SEMS B Screw ... PSB Type	7. Binding Head Screw ... B Type	9. Flat Countersunk Wood Screw ... FC Type	11. Hex. Socket Setscrew ... SC Type	13. Spring Washer ... S Type	15. Retaining Ring (E Washer) ... E Type
2. Washer Head Tapping Screw ... WT Type	4. Pan Head SEMS A Screw ... PSA Type	6. Binding Head SEMS F Screw ... BSF Type	8. Flat Countersunk Head Screw ... F Type	10. Round Head Wood Screw ... RH Type	12. Slot Type Setscrew ... SS Type	14. Plain Washer ... P Type	

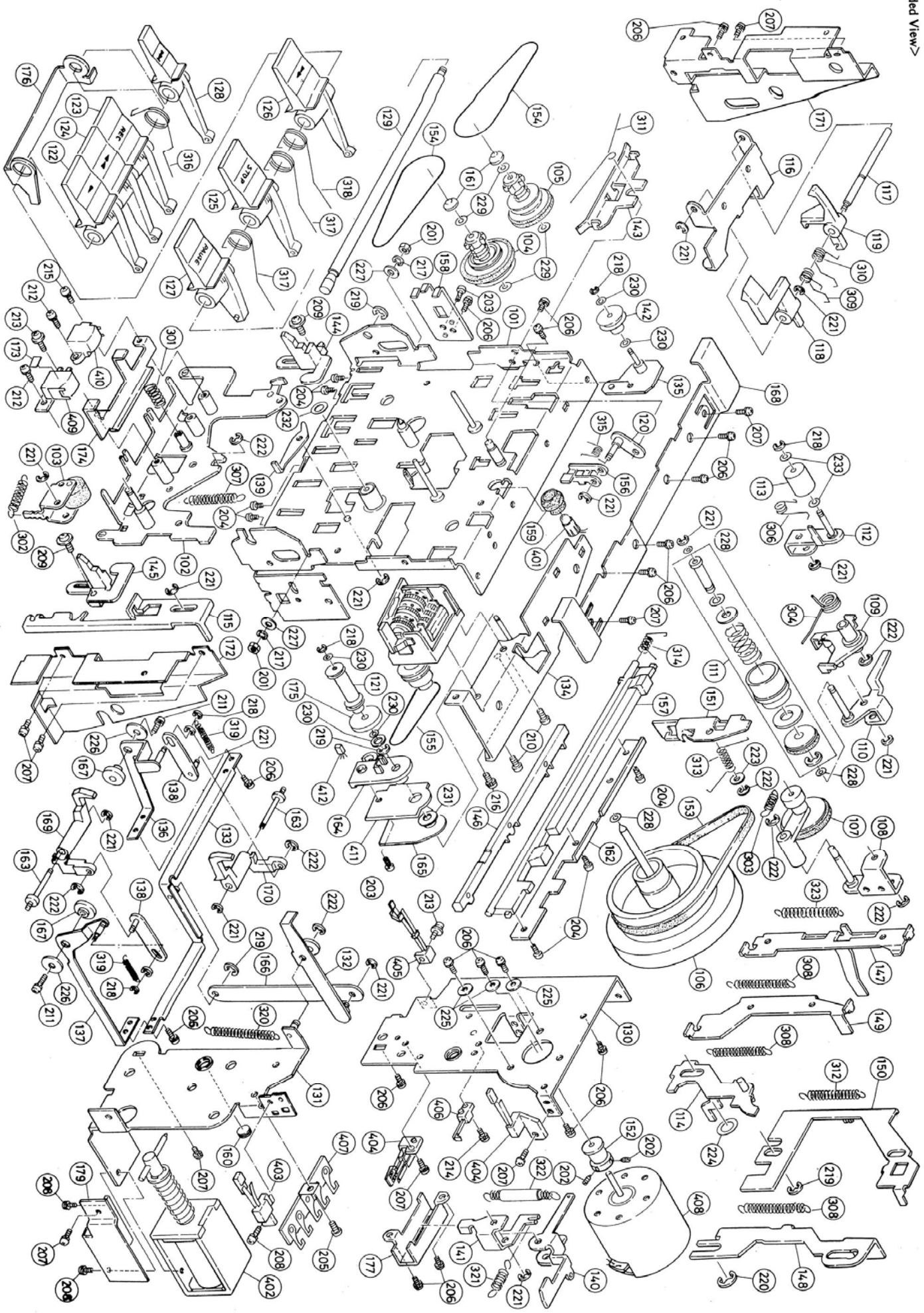

6. OPERATION OF MECHANISM

Fig. 6-1 Mechanism Front View

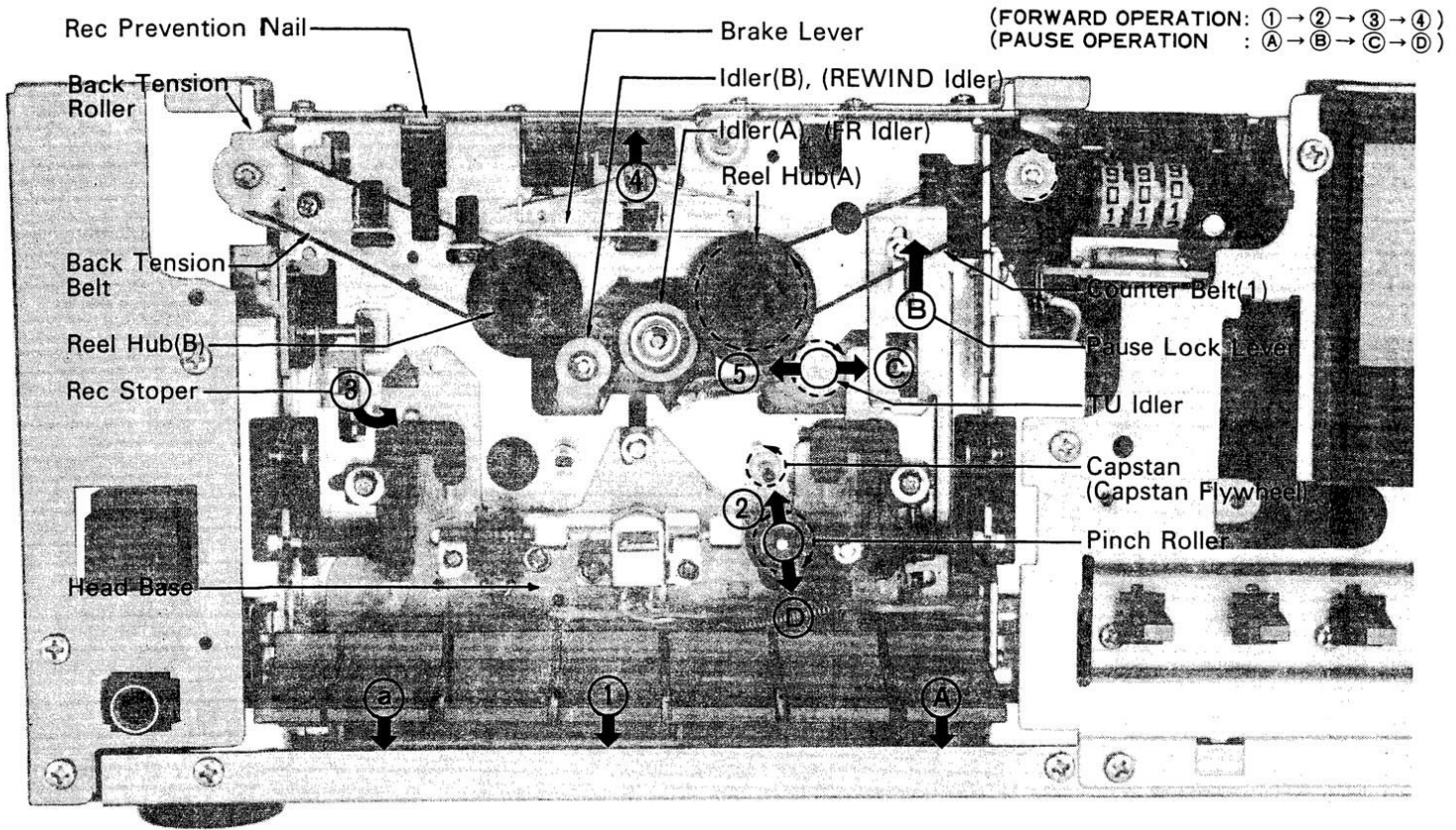

Fig. 6-2 Mechanism Front View

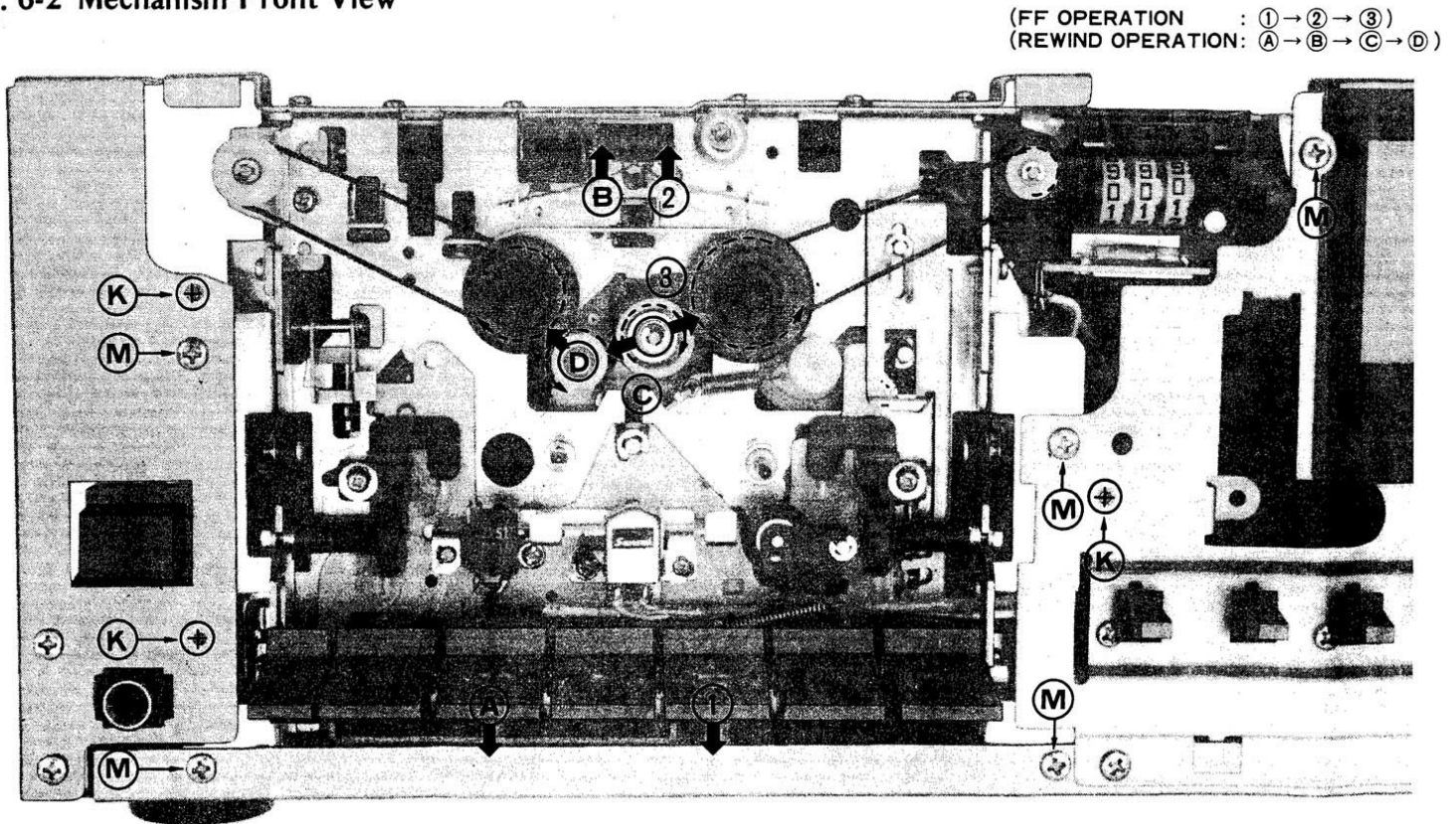
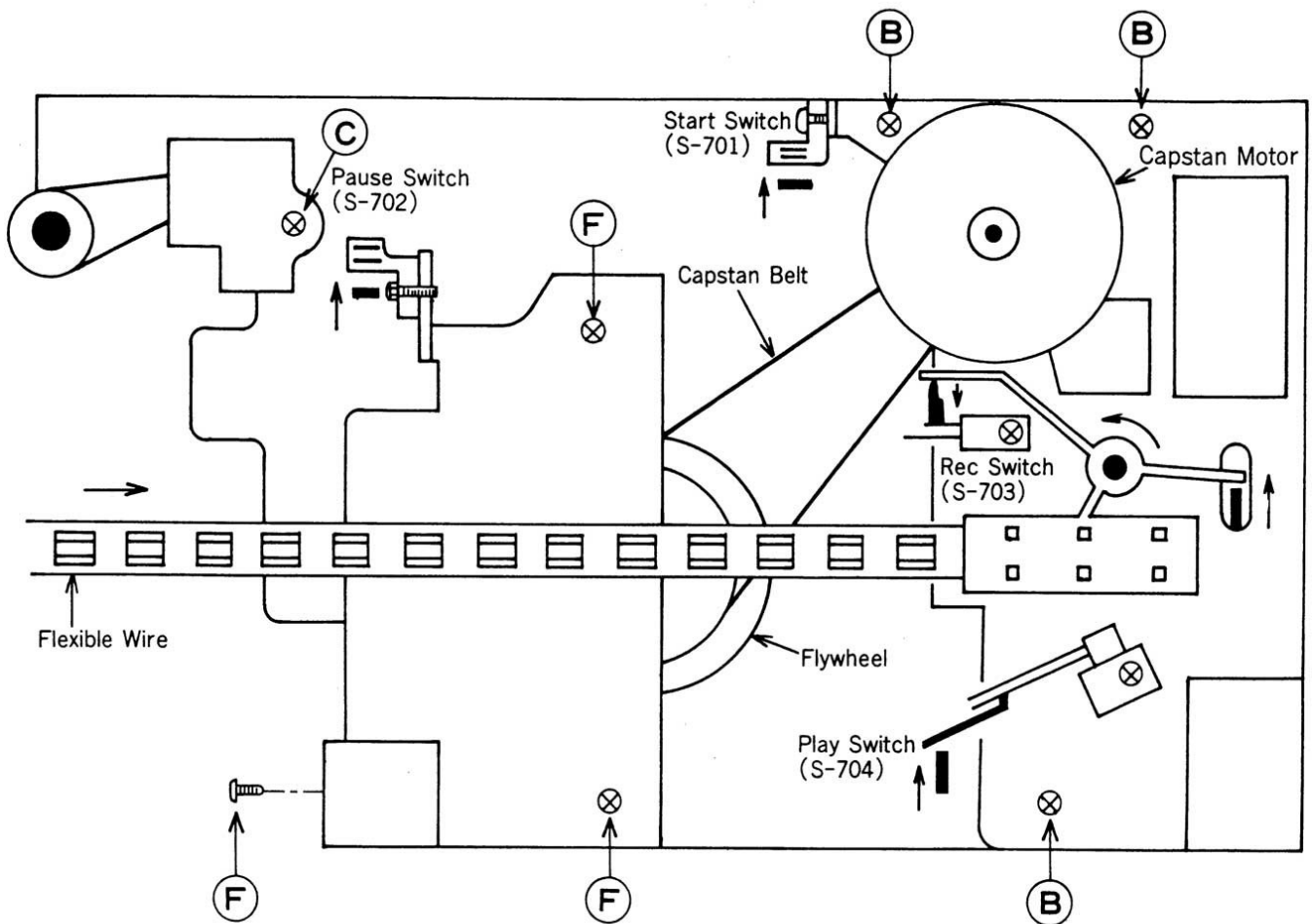

Fig. 6-3 Mechanism Rear View



<Operation>

6-1. Driving Mechanism

Motor begins to rotate by pushing the REWIND, PLAY and FF button. The Driving Motor is an electronically controlled DC Motor and driving torque is transmitted to Flywheel by Motor Pulley and Capstan Belt.

6-2. Play Mode (See Fig. 6-1)

When the PLAY Button is pushed, the head base moves toward the Reel Hub, which makes the Take-up Pulley Shaft bear against the Reel Hub. At the same time, the Brake is released by Brake Lever and Pinch Roller bears against the Capstan Pulley through tape. In accordance with the above, cassette tape gets constant speed running. During Play Mode operation, the Record Button can not be pushed because Rec Stopper Lever is borne to mechanism chassis.

6-3. Fast Forward & Rewind Operation (See Fig. 6-2)

When the FF Button is pushed, the FR Idler bears against the Flywheel and Reel hub (A). When the REWIND button is pushed, the above Mechanism is operated through REWIND Idler between FR Idler and Reel hub (B). The take-up torque in FF MODE is transmitted from Flywheel next FR Idler to Reel hub (A) and REWIND torque is transmitted from Flywheel next FR Idler and REWIND Idler to Reel hub (B). Abnormal torque occurred by tape starting, tape stopping or other causes is absorbed by slipping of felt around FR Idler.

6-4. Pause Mode (See Fig. 6-1, 6-3)

PAUSE operation is only performed in PLAY or REC MODE. When the PAUSE Button is pushed, the Pinch Roller is disengaged from Capstan shaft and Take-up Pulley shaft is disengaged from the Reel hub (A), that tape travel is stopped.

At the same time, Pause switch (S-702) behind mechanism turns on that a voltage is applied to base of TR606 on Automatic Shut off circuit.

As a result, plunger solenoid does not turn on and pause operation is kept on even if voltage from lead switch is not output to stop the rotation of reel hub (A).

6-5. REC Mode (See Fig. 6-1)

The function of tape transport mechanism is the same as that of PLAY MODE operation. A cassette has "tabs" on the side opposite to that exposing the bare tape. If they are broken off, the cassette will prevent the depression of RECORD Button. When the Record Button and the PLAY Button are pushed, the slide switch on G-1266 main circuit board is changed from PLAY MODE to REC MODE.

7. SCHEMATIC DIAGRAM

A B C D E F G H

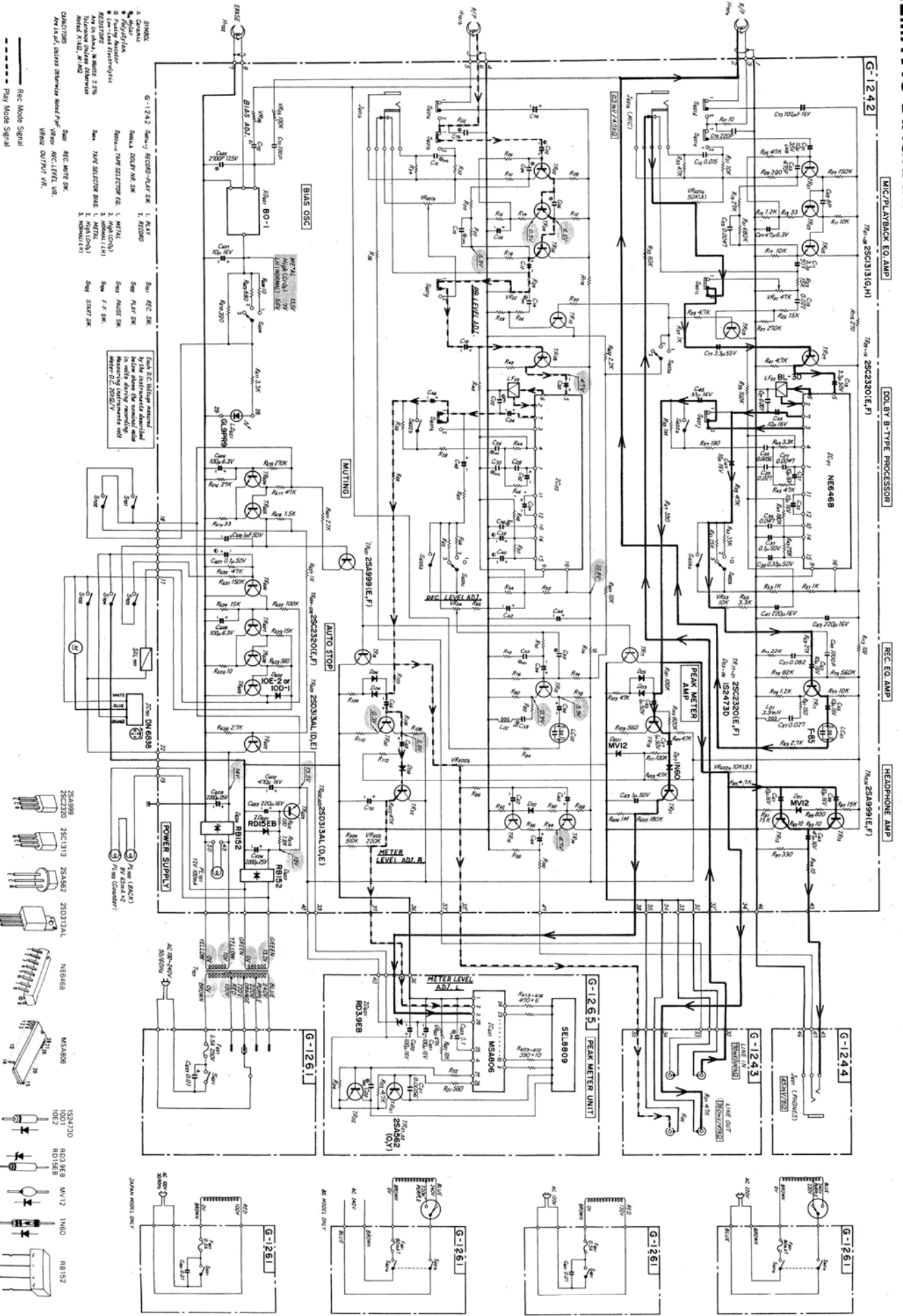

Design and specifications subject to change without notice for improvement.
 * La présentation et les spécifications sont susceptibles d'être modifiées sans préavis par suite d'améliorations éventuelles.
 Ansoopen, für sein Werkstätten: Fernarbeit (Grenze), Stabst. Vorkauf.

1. REC. EQ. AMP. 2SC2320E (F)
 2. HEADPHONE AMP. 2SA999E (F)
 3. PEAK METER UNIT (G-1243)
 4. PEAK METER UNIT (G-1265)
 5. PEAK METER UNIT (G-1261)

8. REPLACEMENT OF MAIN PARTS (See exploded view on page 8)

8-1. Mechanism Ass'y

- 1) Remove bonnet, front panel, and mechanism cover.
- 2) Loosen 5 screws (M). (See Fig. 6-2 on page 9)

8-2. Mechanism Cover

- 1) Remove bonnet and front panel.
- 2) Loosen 3 screws (K). (See Fig. 6-2 on page 9)

8-3. Motor (406)

- 1) Remove bonnet.
- 2) Loosen 3 screws (B) at motor mounting plate. (See Fig. 6-3 on page 9)
- 3) Pull out motor mounting plate (130) then loosen 3 screws (206).

8-4. Capstan Belt (153)

- 1) Remove bonnet.
- 2) Loosen 3 screws (B) at motor mounting plate (See Fig. 6-3 on page 9)
- 3) Pull out motor mounting plate (130).
- 4) Loosen 3 screws (F) fixing flywheel bearing plate.
- 5) Remove flywheel bearing plate.
- 6) Replace capstan belt.

8-5. Reel Hub Ass'y (104), (105)

- 1) Remove bonnet, front panel, and mechanism cover.
- 2) Take off the cap (161).
- 3) Pull off reel hub (A) (104) & reel hub (B) (105).

8-6. Cassette Holder Right Nail (169) & Left Nail (170)

- 1) Remove bonnet, front panel, and mechanism.
- 2) Take off the end of spring (919).
- 3) Remove E ring (77).
- 4) Loosen Nut at the shaft (165) of cassette holder.

8-7. Rec Prevention Nail (119)

- 1) Remove bonnet, front panel, and mechanism cover.
- 2) Loosen 3 screws (B) at motor mounting plate. (See Fig. 6-3 on page 9)
- 3) Pull out motor mounting plate (130).
- 4) Loosen 3 screws (206) at Rec Prevention Nail mounting plate (116).
- 5) Take out Rec Prevention Nail mounting plate (116).
- 6) Remove E ring (77).

8-8. Head Cover

Perform this procedure when making azimuth adjustment or replacing head cover. Since props of head cover are fragile, please pay attention.

- 1) Open head cover about 1 cm (1/3 inch) and this anguration is important to remove it.
- 2) Lift the head cover keeping the angulation above.
Putting forefinger in the 1 cm space (between head cover and mechanism cover) and lifting head cover to hold it by thumb and forefinger make easier to take off the first hooking (See Fig. 8-1)
- 3) Hold head cover close to mechanism cover, then lift it keeping this state till the possible point the head cover is lifted up.
- 4) While pressing both sides of head cover inward, remove head cover carefully. (See Fig. 8-2)
- 5) To attach head cover, perform step 3) inversely at first, then depress down after inserting to supporting groove.

Fig. 8-1

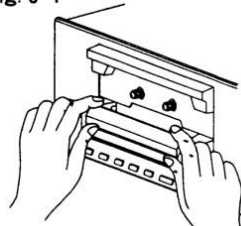
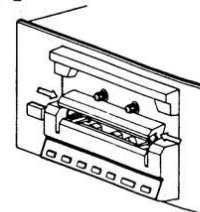
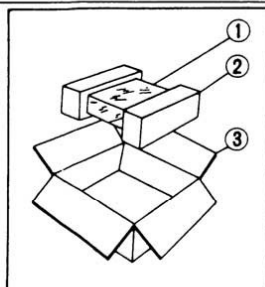

Fig. 8-2



9. PACKING LIST

Parts No.	Stock No.	Description
1	91166910	Vinyl Cover
	91200500	Polyethylene Sheet <SC-1300>
2	90301700	Styrofoam Packing <SC-1300>
	90301600	Styrofoam Packing <SC-1330>
3	90500100	Carton Case <SC-1300>
	90500200	Carton Case <SC-1330>



10. ACCESSORY PARTS LIST

Stock No.	Description
92053400	Operating Instructions <SC-1300>
92053700	Operating Instructions <SC-1330>
92303000	Schematic Diagram
94300300	Head Cleaning Pen x 1
38103300	Input-Output Cord x 2
72963600	Rack Mounting Adaptor x 2 <SC-1330>