

SERVICE MANUAL

STEREO CASSETTE TAPE DECK

SANSUI SC-5300 SC-5330

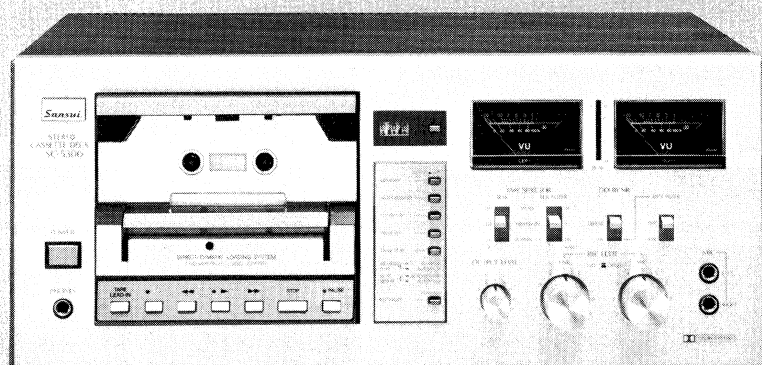

SPECIFICATIONS

- Track 4-Track (2-Channel Stereo)
- Tape speed 4.8 cm/sec. (1-7/8 ips)
- Heads Record/Playback: FH Head
Erase: Double Gap Ferrite Head
- Motor Capstan: FG Servo DC Motor
Reels: DC Motor
- Wow and flutter within 0.038 % WRMS
- Fast wind time approximately 70 seconds (C-60)
- Frequency response (Record/Playback)
Normal Tape (LH) (-20VU)
. 20 to 17,000 Hz
(20 to 15,000 Hz ± 3 dB)
- Metal Tape (-20 VU)
. 20 to 21,000 Hz
(20 to 20,000 Hz ± 3 dB)
(0 VU) 20 to 15,000 Hz ± 3 dB
- Signal to noise ratio (Record/Playback)
Metal Tape (without Dolby Noise Reduction Effect)
. better than 59 dB (weighted)
(With Dolby Noise Reduction)
. better than 69 dB (above 5 kHz)
- Erasure factor (Metal Tape)
. more than 70 dB at 1,000 Hz
- Input sensitivity and impedance (0 VU, 1,000 Hz)
MIC 0.2 mV/200 Ω ~ 5 k Ω
LINE IN (REC) 70 mV/33 k Ω
- Output level (0 VU, 1,000 Hz)
LINE OUT (PLAY)
. 400 mV
PHONES 100 mV/8 Ω
- Bias frequency 85 kHz
- Power requirements
Power voltage 100, 120, 220, 240 V
(50/60 Hz)
For U.S.A. and Canada
. 120 V (60 Hz)
- Power consumption
. 35 W (rated)

Dimensions

<SC-5300>

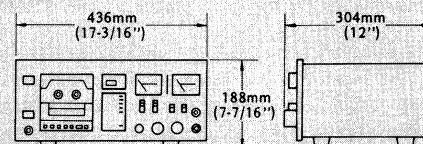

<SC-5330>

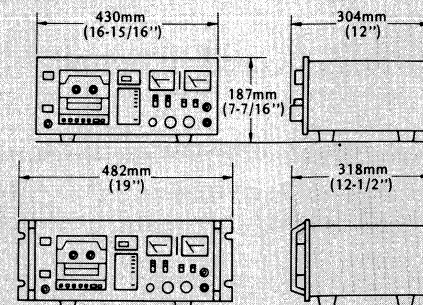

- Weight <SC-5300>
8.5 kg (18.7 lbs.) net
9.7 kg (21.4 lbs.) packed
- <SC-5330>

1. BLOCK DIAGRAM

◆ Recording Operation (L-CH)

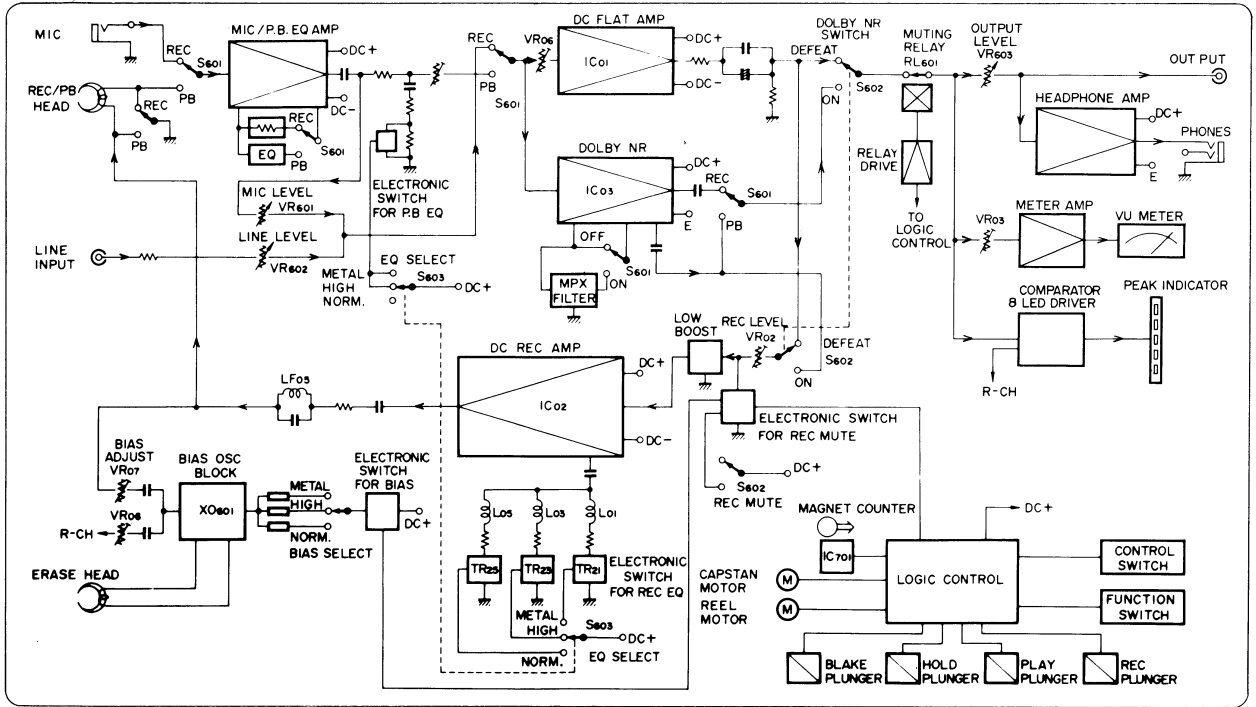

2. OPERATION

2-1. Operation of Electric Circuits (Refer to block diagram and schematic diagram.)

1. Functions and Operations of C-MOS LSI Employed in Logic Control Circuit

In these models, Full Logic Feather Touch Control is realized by using a logic control circuit whose main components are C-MOS LSI (Model TC9121P) and plunger solenoids.

The function and operation of the TC-9121P are as follows:

- Regarding the respective modes, operation is actuated when the LSI input is dropped instantaneously to the L-level. The operation is sustained until the set is changed over to next mode.
- A circuit preventing troubles caused by multiple-pushing of input keys is provided in the LSI. (Refer to Table Fig. 2-2.)
- Although the mode of PLAY, REC, REW, F.F. and MUT output terminals of LSI whether H or L can be changed directly, output

is not appeared for approximately 0.5 second in order to protect the tape and the set's mechanisms. Terminals other than those just stated start operating immediately. For example, if the PAUSE mode is released either in the REC PAUSE mode or PLAY PAUSE mode, each output changes over immediately when the PAUSE button is depressed. The stop duration of operations is determined by the C and R connected to the OSC terminal.

- When power is switched on, the mode is shifted to "STOP" automatically.
- Automatic recording and automatic playback based on the use of a timer are possible.
- Owing to the large current capacity of LSI, the control of the motor and plunger is easier. The LEDs indicating the respective modes can be lighted up directly.

Fig. 2-1 Top view & pin function of IC TC-9121P

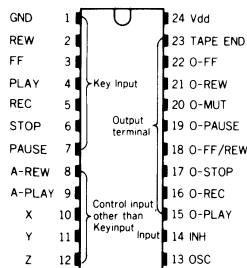

Fig. 2-2 Mode produced by multiple-pushing of keys.

Key Input	Other Key Input	Output Mode
STOP	REW, FF, PLAY, REC, PAUSE	STOP
FF	REW, PLAY	STOP
	REW, PAUSE	FF
REW	FF, PLAY	STOP
	REC, PAUSE	REW
PLAY	PAUSE	PLAY PAUSE
REC	PLAY	REC
	PAUSE	PAUSE
	PLAY & PAUSE	REC PAUSE

Example: If, the F.F. Key and REW Key are depressed together, the output mode will change to "STOP". On the other hand, when the REC and PLAY keys are depressed together, the output mode becomes "REC".

Fig. 2-3 Mode of each output terminal for each key input (The "O" mark indicates the H-level output.)

Pin No.	Key Input	PAUSE		
		STOP	FF	REW
15	O-PLAY			
16	O-REC			
17	O-STOP	O	O	O
18	O-FF/REW	O		
19	O-PAUSE			
20	O-MUT	O	O	O
21	O-REW			
22	O-FF			
23	TAPE END	O	O	O

Note: The output of O-FF/REW has the function of accelerating the motor speed in F.F. and REW operation, and at the same time, of preventing the PLAY indicator LED from lighting up.

2-2. Operation of Mechanical Section (See Fig. 2-4, 2-5)

1. Release of Brake and Operation of Hold Lever

- 1) When either of the control buttons PLAY or REC is depressed, the play plunger (C) turns on, causing the head base to lift up. This, in turn, causes the brake lever to lift up to release the brake.
- 2) When one of control buttons FF, REW and LEAD IN is depressed, the brake plunger is turned on, causing the brake lever to lift and the brake to be released.
- 3) Since the hold lever moves inward in all modes other than in STOP (because the hold plunger (A) is "ON"), the cassette half is held by hold lever.

2. PLAY Operation (See Fig. 2-4, 2-5)

- 1) When the cassette half is set on the holder, the cassette play sensor is lifted up, causing the half switch to turn on. In this mode, the capstan motor starts rotating.
- 2) This torque of the capstan motor is transmitted to the capstan belt, capstan flywheel and capstan in that order.
- 3) When the play plunger (C) turns on, the head base rises, causing the pinch roller to be pressed against capstan and the tape to start travelling. At the same time, when the head base rises, the tension arm ass'y moves down in order of "X" "Y" "Z", and then presses against the take-up ass'y, transmitting the revolution of the motor to the take-up ass'y. The tape is taken up as a result.

3. REC Operation (See Fig. 2-4, 2-5)

- 1) The fundamental operation is quite similar to the play operation. When the cassette half is set on the holder, the REC sensor lever is lifted up, causing REC sensor switch to turn on. By this, the logic circuits is enabled to perform REC operation.

- 2) When the REC button is depressed, the REC plunger turns on, causing the PLAY/REC amplifier circuit to be switched over to REC.

4. FF Operation (See Fig. 2-4, 2-5)

- 1) To depress FF button causes the brake plunger (B) to turn on so that the brake is released, simultaneously the F.R. idler to be lifted up and to be pressed against the shaft of the reel motor. (Point G)
- 2) In the F.F. mode, the reel motor rotates at high speed. This torque is transmitted to the F.R. idler.
- 3) The F.R. idler moves to the left and right centering fulcrum H. When the rotation of the reel motor is transmitted to the F.R. idler, the idler moves rightward centering the fulcrum, causing it to press against the take-up ass'y and transmit the rotation.

5. REW Operation (See Fig. 2-4, 2-5)

- 1) The fundamental operation is quite similar to the F.F. operation. However, as the counterclockwise rotation of the reel motor is transmitted to the F.R. idler, the F.R. idler moves leftward centering the fulcrum and presses against the take-up ass'y to transmit the rotation.

6. Roller Back Tension (See Fig. 2-4)

- 1) The rotation of the supply ass'y is transmitted to the back tension roller by means of the back tension belt. In conventional method to apply back tension, the tension is varied because the diameter of the rest tape rolled is changed. However, in the "roller back tension system" the constantly stabilized back tension can be applied since the system is utilizing the roller's friction of rotation. Therefore extremely smooth feed-out of tape and improvement of wow & flutter can be realized.

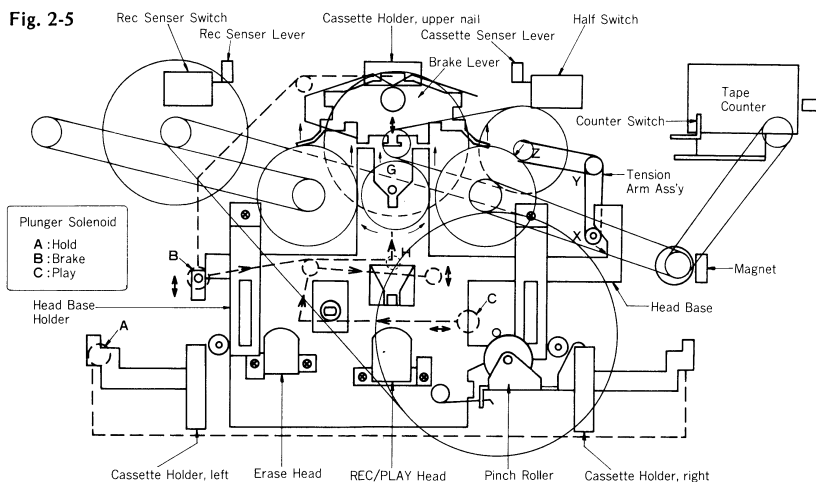
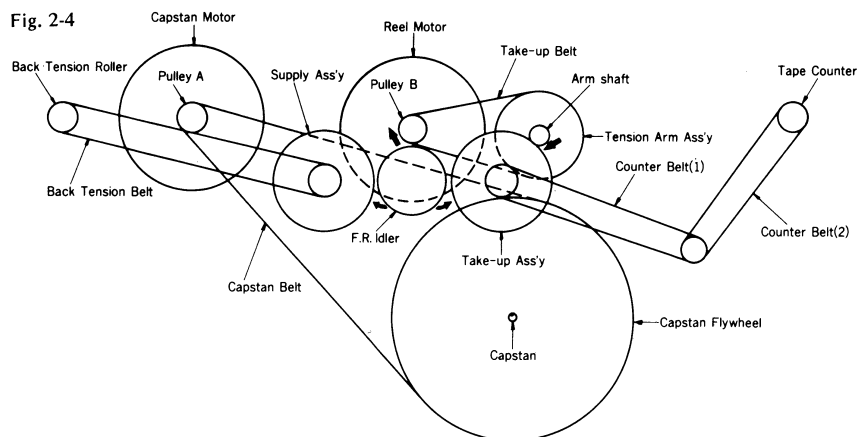

3. ADJUSTMENTS

3-1. Adjustment of Electric Circuit

1. DC 0V Adjustment of Amp Circuit Board (G-1249) (See Top View on page 7)

STEP	SUBJECT	MEASURE OUTPUT	ADJUST	ADJUST FOR	REMARKS
1.	DC 0V (L-CH)	Between chassis and JW25 on F-1249 (Common collector joint of TR07, TR09)	VR01 (L-CH) G-1249	0V ±100mV	1. For adjustment, run the unit for more than 5 minutes after the power is switched on. 2. Adjust at stop mode.
2.	DC 0V (R-CH)	Between chassis and JW35 on F-1249 (Common collector joint of TR08, TR10)	VR02 (R-CH) G-1249	0V ±100mV	

2. Tape Speed Adjustment

- Note: 1. Use Sansui Test Tape, SCT-S3K (3 kHz signals are recorded on the tape).
2. Connections are shown in Fig. 3-1.

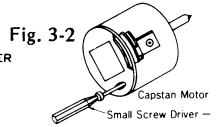
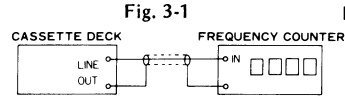

STEP	SUBJECT	INPUT SIGNAL	CHECK POINT	SETTING	ADJUST	ADJUST FOR	REMARKS
1.	TAPE SPEED ADJ.	Test Tape SCT-S3K	LINE OUT	Depress the PLAY button and play back the Test Tape, SCT-S3K	Semi-Variable Resistor within the capstan Motor (See Fig. 3-2).	3000 Hz ±45 Hz	Use small screw driver.

3. Playback Adjustment

- Note: 1. Before this adjustment, clean REC/P.B head surface.
2. Set the output level volume to be maximum.
3. For this adjustment, use Sansui Test Tape, SGT-F10KN and SCT-L400N.
4. Set the Dolby switch to be Defeat.
5. Connections are shown in Fig. 3-3.
6. Set the Line Volume to be maximum.

Note: Azimuth adjustment can be carried out from front side without removing head cover (See Fig. 4-1 on page 5)

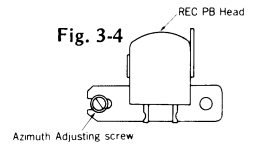
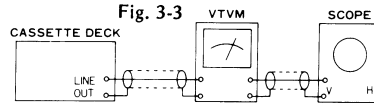

STEP	SUBJECT	INPUT SIGNAL	CHECK POINT	SETTING	ADJUST	REMARKS
1.	REC/PB Head Adj.	SCT-F10KN	LINE OUT VTVM Scope	Depress the PLAY button and play back the Test Tape, SCT-F10KN	Adjust the azimuth adjusting screw in Fig. 3-4 for the maximum reading on the VTVM on both channels.	After this adjustment, lock the screw with paint.
2.	Playback Level Adj. (Dolby ON)	SCT-L400N	Same as above	Set EQ SELECTOR to NORMAL (LH) position. Depress the PLAY button and playback the Test Tape, SCT-L400N. Set the Dolby switch to be ON.	Adjust VR03 for L-CH and VR04 for R-CH for the reading of 560 mV on VTVM. (G-1249/ See Top View on page 7)	Set same level (560 mV) ± 2 dB on both channels.
3.	Playback Level Adj. (Dolby Defeat)	Same as above	Same as above	Set EQ SELECTOR to NORMAL (LH) position Depress the PLAY button and playback the Test Tape, SCT-L400N. Set the Dolby switch to be Defeat.	Adjust VR05 for L-CH and VR06 for R-CH for the reading of 560 mV on VTVM. (G-1249/See Top View on page 7)	Repeat step 2, 3 and confirm output is 560 mV when Dolby NR switch is in an either on or Defeat position.

4. Recording Adjustment

1) Bias Adjustment

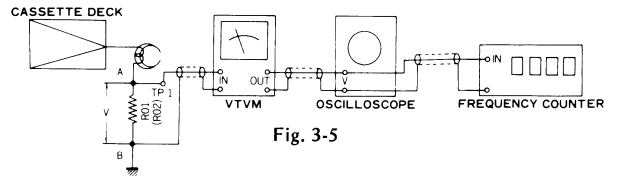

STEP	SUBJECT	INPUT SIGNAL	CHECK POINT	SETTING	ADJUST	REMARKS
1.	Recording bias Adj.	SCT-SA	Voltage value between A and B in Fig. 3-5.	Depress REC, PLAY and PAUSE buttons. Set BIAS SELECTOR to HIGH (CrO ₂) position.	Adjust VR07 for L-CH and VR08 for R-CH for the reading of 6.0 mV between A and B in Fig. 3-5 on both channels.	VR07, VR08 F-1249 See Top View on page 7.
				Set BIAS SELECTOR to NORMAL (LH) position.	Confirm the indication on VTVM shows 4.6 mV.	
				Set BIAS SELECTOR to Metal position.	Confirm the indication on VTVM shows 9.2 mV	

2) Rec Level & Frequency Response Adjustment

Note: 1. Output Level Volume Maximum.
2. Connections are shown in Fig. 3-6.

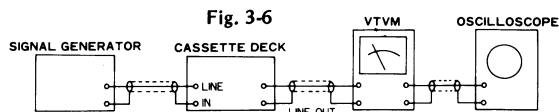

STEP	SUBJECT	INPUT SIGNAL	CHECK POINT	SETTING	ADJUST	REMARKS
1.	REC Level Adj.	Use recording HIGH (CrO ₂) tape SCT-SA Feed 1 kHz, 70 mV (0 dB) from S.G into LINE IN.	LINE OUT VTVM Scope	Set TAPE SELECTOR to HIGH (CrO ₂) position & Dolby NR switch to Defeat position. 1. Depress PAUSE, PLAY and REC button. 2. Adjust the Rec Level Volume for obtaining 300 mV on VTVM. 3. Push off the PAUSE button, then record the 1 kHz signal. 4. Play back the 1 kHz signal. 5. Confirm that the output levels on both channels are 300 mV ± 2 dB on VTVM.	1. If not, turn VR01 for L-CH and VR02 for R-CH until output level 300 mV ± 2 dB on both channel are obtained. 2. Repeat this REC Level adj. until the indication on VTVM will be 300 mV ± 2 dB.	VR01, VR02 (G-1242) See Top View on page 7
2.	Frequency Response Adj.	Feed 1 kHz 7 mV (-20 dB) and 10 kHz; 7mV(-20dB) from S.G. into LINE IN.	LINE OUT	Set TAPE SELECTOR to HIGH (CrO ₂) position & Dolby NR switch to Defeat position. 1. Record the 1 kHz and 10 kHz signals from S.G. 2. Play back the 1 kHz and 10 kHz signals, then confirm that the difference of output levels between 1 kHz and 10 kHz are within 0 dB against that of 1 kHz.	1. If not, adjust VR07 for L-CH and VR08 for R-CH slightly until difference of output levels between 1 kHz and 10 kHz recorded are within 0 dB against that of 1 kHz.	As VR07 and VR08 are previously adjusted in step of Bias Adjustment, turn them slightly, if necessary.

5. VU Meter Adjust

Note: Output Level Volume Max.

STEP	SUBJECT	INPUT SIGNAL	CHECK POINT	SETTING	ADJUST	ADJUST FOR
1.	L-CH	Feed 1 kHz 70 mV from S.G. into LINE IN SCT-SA	LINE OUT VTVM	1. Depress PAUSE, PLAY and REC button. 2. Adjust the Rec Level Volume for obtaining 400 mV on VTVM.	VR03 (F-1250)	Set the pointer of VU meter to 0 dB
2.	R-CH	Same as above	Same as above	Same as above	VR04 (F-1250)	Same as above

◇ Tape Selector Position

Tape Selector		REC	PLAY
Tape		Bias/Equalizer	Equalizer
FUJI	Super Range	metal	metal
MAXELL	MX		
TDK	MA-R		
SCOTCH	Metafine		
SONY	METALLIC		
FUJI	Range 4X	high(CrO ₂)	high(CrO ₂)
MAXELL	XL II		
TDK	SA		
SCOTCH	MASTER 70		
SONY	JHF		
BASF	SCR		

Tape Selector		REC	PLAY
Tape		Bias/Equalizer	Equalizer
SONY	Duad	normal(LH)	high(CrO ₂)
BASF	FCR		
FUJI	Range-2	normal(LH)	normal(LH)
	Range-4		
	Range-6		
MAXELL	UL		
	UD		
	XL I		
TDK	D		
	AD		
	OD		

Tape Selector		REC	PLAY
Tape		Bias/Equalizer	Equalizer
SCOTCH	TARTAN	normal(LH)	normal(LH)
	CRYSTAL		
	MASTER 120		
SONY	AHF		
	BHF		
	CHF		
	Low-Noise		
BASF	LN		
	Super LH I		

◇ List of Sansui Test Tape

Name of test tape	Recorded Frequency	Description	Name of test tape	Recorded Frequency	Description
SCT-S3K	3KHz	Speed check, Wow & Flutter check	SCT-SA(HIGH(CrO ₂))		Recording Bias Adjustment
SCT-L400N	400Hz	Playback level and VU meter level adjustment	SCT-LH(NORMAL(LH))		REC/PB Level Adjustment
SCT-F1K	1KHz	High frequency equalization check	SCT-CS(Fe-Cr)		Frequency response check
SCT-F10KN	10KHz	REC/PB head adjustment	SCT-F40	40Hz	Playback Frequency response check

3-2. Mechanism Adjustment

1. Half Switch

Perform this adjustment when replacing half switch or in case that this switch doesn't turn on even if cassette half is set.

- 1) Confirm half switch turns on when half is set. If half switch does not turn on, adjust screw above the switch then reconfirm it switch can be turned on (See Fig. 3-7)
(To confirm with several marker's cassette half is recommended)

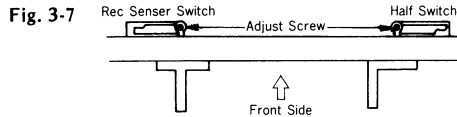

2. Rec Sensor Switch

- 1) Confirm rec sensor does not turn on when cassette half without accidental erasure preventing tab is set.
- 2) Confirm rec sensor turns on when cassette half with accidental erasure preventing tab is set.
- 3) If step 1, 2 are not normally functioned, adjust screw above rec sensor switch.

3. Flywheel Thrust Screw

Perform this adjustment when replacing and removing capstan flywheel

- 1) Confirm the thrust (the play of front & rear direction) is within approximately 0.1 mm to move capstan in the front and rear direction. If thrust is too large, operation of capstan is not precisely performed therefore causing tape flow and if thrust is too little, the capstan rotation becomes rough.
- 2) In case, capstan rotation is rough, adjust flywheel thrust screw under the play plunger solenoid.

4. Pressure of Pinch Roller

The pressure of pinch roller can be adjusted by following two steps

- 1) If the pressure is weak, hook the end of spring to the hole outside (1).
- 2) If the pressure is strong, hook the end of spring to the hole inside (2).

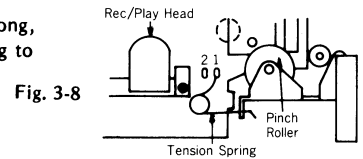

4. MAIN PARTS REPLACEMENT (See exploded view on page 6)

4-1. Capstan Motor

- 1) Remove bonnet.
- 2) Take off 2 springs hooked to the capstan motor mounting board.
- 3) Loosen 3 screws fixing motor mounting board.
- 4) Loosen 3 screws (No. 208) fixing motor to motor mounting board.

4-2. Reel Motor

- 1) Remove bonnet, front panel, and mechanism cover.
- 2) Loosen fixing screws (A), (B) (See Front View on page 9)
- 3) Remove cassette holder (upper nail), then loosen upper side motor mounting screw from the gap behind cassette holder (upper nail).
- 4) Take off the reel motor.

4-3. Supply Ass'y & Take-up Ass'y

- 1) Loosen a screw (No. 204) fixing reel hub ass'y shaft (No. 114) to supply/take up ass'y.
- 2) Remove supply/take-up ass'y after pulling out reel hub ass'y to this side.

Note: Pay attention not to loose 2 washers for mounting reel hub ass'y.

4-4. Rec Sensor Switch

Remove capstan motor, then loosen 2 screws fixing the switch from the mounting hole for capstan motor.

4-5. Capstan Belt & Capstan Flywheel

- 1) Remove mounting board fixing play plunger solenoid. (it is not necessary to take off plunger solenoid it self)
- 2) Pull out capstan flywheel from the gap after removing mounting board.
- 3) Remove a spring (No. 302) attached to head base driving plate.
- 4) Remove capstan belt.

4-6. Tension Arm Ass'y

- 1) Loosen 5 screws fixing mechanism chassis (No. 102) (Screws at the props supporting front chassis (No. 101) & mechanism chassis (No. 102))
- 2) Pull out the chassis toward inside.

4-7. F.R. Idler

- 1) Remove head base (No. 105) by following procedure.
 - o Remove mechanism holder (right) (No. 157)
 - o Remove cassette holder (right side)
 - o Remove pinch roller ass'y (No. 108)
 - o Loosen a screw (No. 210) under play/rec head and remove head base fixing plate spring (No. 160). (Pay attention not to loose the steel ball (No. 226))
 - o Remove head base (Pay attention not to loose the steel ball under head base)
- 2) Remove capstan flywheel to follow step 4-5.
- 3) Remove E ring (No. 222) at the prop of FR idler.
- 4) Pull out FR idler to this side from the gap where head base is removed.

4-8. Head Cover

Perform this procedure when making azimuth adjustment or replacing head cover. Since props of head cover are fragile, please pay attention.

- 1) Open head cover about 1 cm (1/3 inch) and this angulation is important to remove it.
- 2) Lift the head cover keeping the angulation above.
Putting forefinger in the 1 cm space (between head cover and mechanism cover) and lifting head cover to hold it by thumb and forefinger make easier to take off the first hooking (See Fig. 4-1)
- 3) Hold head cover close to mechanism cover, then lift it keeping this state till the possible point the head cover is lifted up.
- 4) By pressing both sides of head cover inward, remove head cover carefully. (See Fig. 4-2)
- 5) To attach head cover, perform step 3) inversely at first, then depress down after inserting to supporting groove.

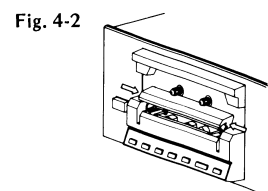
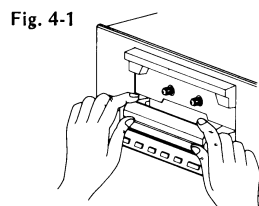

* Performing procedures 1) ~ 3) make it possible to insert a screw driver to the hole for azimuth adjustment.

SC-5300/5330 SC-5300/5330

5. PARTS LIST OF MECHANISM Ass'y (Exploded View)

Parts List

Parts No.	Stock No.	Description
106	07527400	Wire Stopper
108	70603000	Pinch Roller Ass'y
109	70402200	Fly wheel
110, 164, 165, 222)	70603100	FR Idler Ass'y (No. 110, 164, 165, 222 Included)
111	70900300	Tension Arm Ass'y
112	70603200	Supply/Take-up Ass'y
114	71501300	Reel Pin Ass'y
116	65010200	Cassette Holder, upper nail
126	70603300	Counter Idler Ass'y
128	65010500	Cassette Holder, right
127	65010600	Cassette Holder, left
129	07529400	Bracket Lever
129	60302200	Counter Belt (L)
130	60302400	Counter Belt (R)
131	56000200	Bulb/ing Lamp holder
132	51604000	Flywheel Thrust Screw
136	07529500	Ring
141	71300100	Motor Pulley
142	07529600	Brake Lever
146	65010700	Insert Shaft
147	07529700	Rec. Sensor Lever
150	65010800	Cassette Sensor Lever
152	54301400	Tape Counter
153	60107100	Back Tension Pulley
154	50007600	Motor Cushion
159	61401800	Motor Pulley
161	07529800	Take-up Belt
162	07529900	Capstan Belt
201	08321100	Tapping Screw, 2.6 x 8
202	08322700	Tapping Screw, 2 x 12
203	08322300	Hex Socket Set Screw
204	08322900	Hex Socket Set Screw
205	51059110	Taprite Screw, 2 x 10
206	08321200	Taprite Screw, 3 x 5
207	08321300	SEMS A Screw, 2.6 x 4
208	08322900	SEMS B Screw, 2.6 x 7
209	08321400	SEMS A Screw, 2.6 x 6
210	08321500	SEMS A Screw, 2 x 5
211	08321700	SEMS A Screw, 3 x 10
212	08322100	SEMS A Screw, 3 x 6
213	08321900	SEMS A Screw, 2 x 6
214	08321500	Serrated Washer Head Screw, 2 x 5
215	08321900	Plain Head Screw, 2 x 5
216	08322000	Binding Head Screw, 3 x 5
217	08323400	Thrust Washer, 2.2 x 9.5 x 0.2
218	51804500	Thrust Washer, 2.1 x 5 x 0.25
219	51804400	Thrust Washer, 2.5 x 5 x 0.25
220	08323000	Plain Washer, 2.2 x 8 x 0.5
221	08323500	Thrust Washer, 2.4 x 6 x 0.5
222	08322600	E Ring, 1.5 x 0.4
223	51510200	E Ring, 2 x 0.4
224	08322600	E Ring, 2.5 x 0.4
225	51510400	E Ring, 3 x 0.8
226	65400300	Steel Ball, 2φ
(Screw)		
301	69011000	Head Adjust
302	69017300	Head Base
303	07527000	Play Plunger Reset
304	69017400	Brake
305	69017600	Pinch Roller
306	69017500	Changing Lever
307	69017700	Tension Pulley
308	69017800	Brake Lever
309	69017900	Limiter Plate
310	69018000	Lever Joint
311	69017200	Hold Lever
401	45368700	PLAY/REC Head
402	45260400	Erase Head
403	44038100	Illumination Lamp, 8 V 65 mA
404	43402600	Play Plunger
405	43402700	Plunger Solenoid, brake
406	43402800	Plunger Solenoid, hold
407	45207600	Reel Motor
408	11831100	Micro Switch
409	43295200	Capstan Motor
410	0364000	IC, DN8638

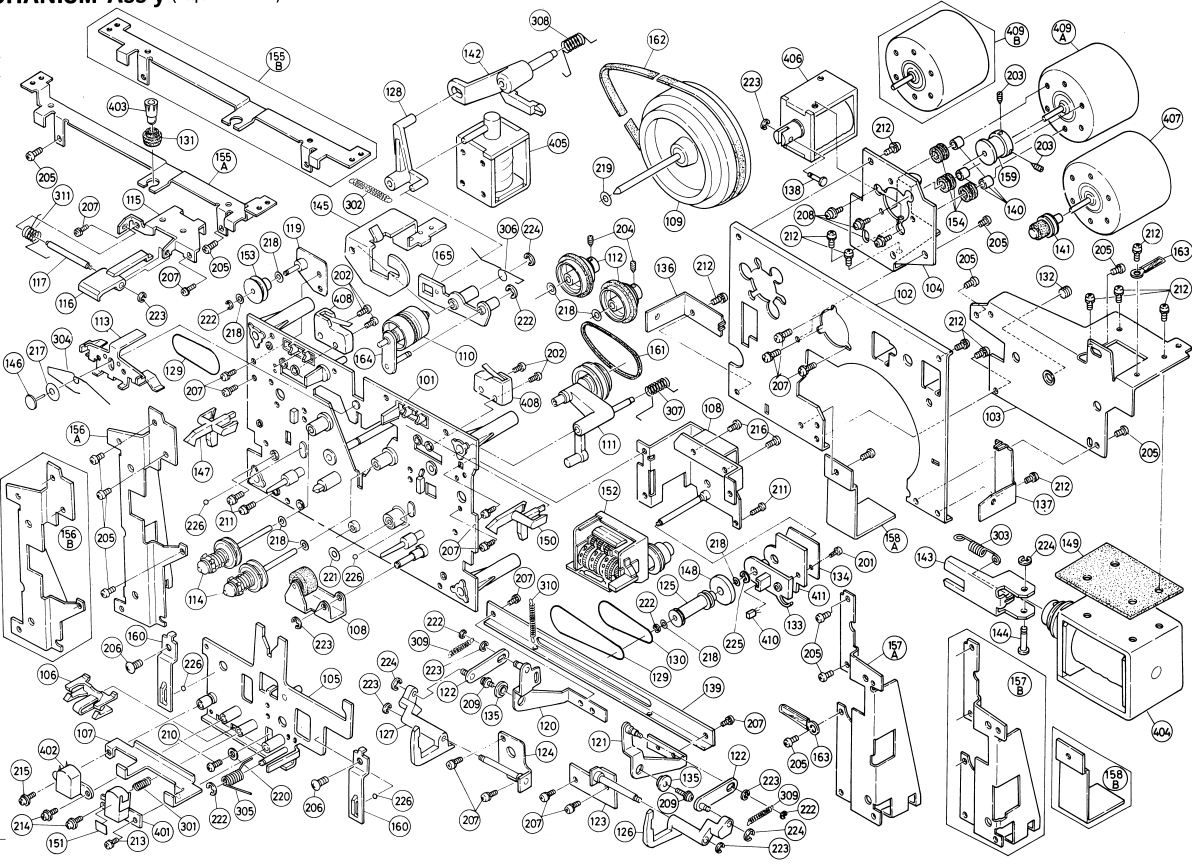

Abbreviations

1 Fan Head Tapping Screw PT Type	3 Plain Head Screw P Type	5 Pan Head SEMS B Screw PSB Type	7 Binding Head Screw B Type	9 Flat Countersunk Wood Screw FC Type	11 Hex Socket Set Screw SC Type	13 Spring Washer S Type	15 Retaining Ring (E Washer) E Type
2 Washer Head Tapping Screw ST Type	4 Fan Head SEMS A Screw PSAA Type	6 Binding Head SEMS B Screw PSB Type	8 Flat Countersunk Head Screw H Type	10 Round Head Wood Screw RT Type	12 200 Type Set Screw SS Type	14 Plain Washer P Type	

*Though every part included in mechanism ass'y is numbered in exploded view, part unlisted in the parts list are not supplied.

6. OTHER PARTS

6-1. Front View

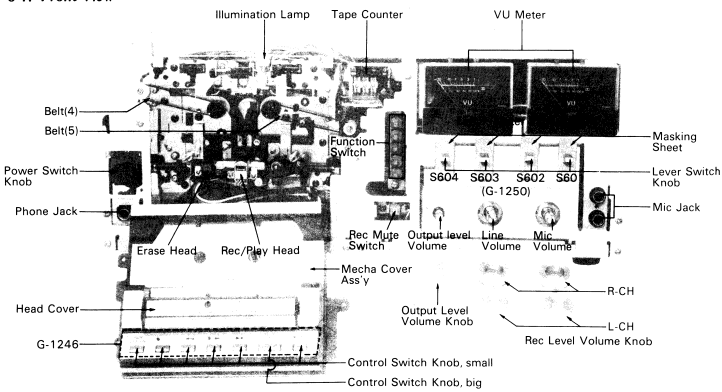

6-3. Side View

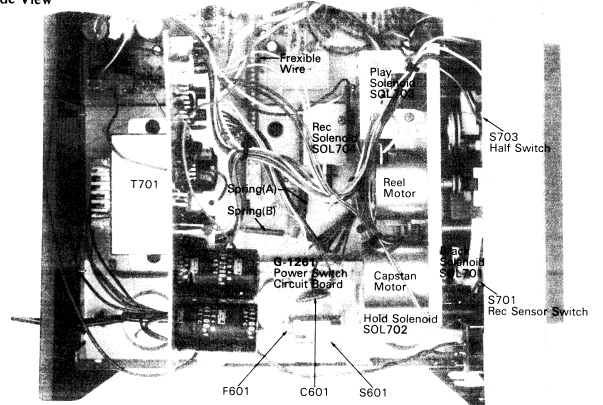

6-2. Top View

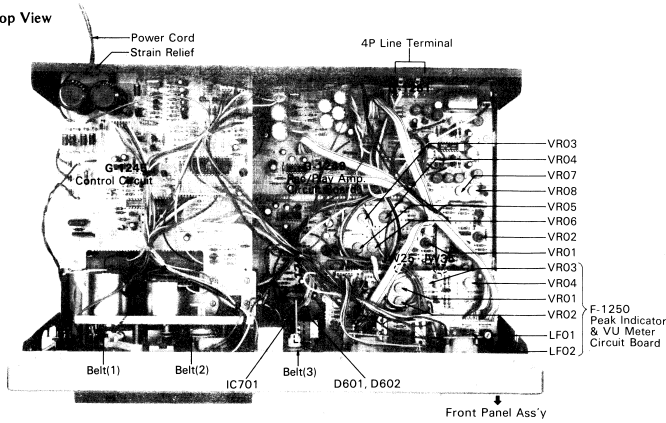

Parts List <Front View>

Parts No.	Stock No.	Description
G-1250	11720800	MPX Filter Switch
S601	11721100	Dolby NR Switch
S602	11721200	EQ Switch
S603	11721300	Bias Switch
S604	11721000	Illumination Lamp, 8V 65 mA
	04008100	Tape Counter
M701, 702	43014200	VU Meter
	60302200	Belt (4), back tension
	60302200	Belt (5), counter
	71063110	Power Switch Knob
	24305400	Phone Jack
	45260400	Erase Head
	45360600	Rec/Play Head
	11319700	Function Switch
	11319800, 1	Rec Mute Switch
	10156400, 1	Output Level Volume, 10kΩ (B) x 2
	10250400, 1	Line Volume, 50kΩ (A) x 2
	24305600	Mic Volume, 50kΩ (A) x 2
	50502700	Mic Jack
	70004400	Head Cover
	70004310	Mecha Cover Ass'y (B)
	53206600	Mecha Cover Ass'y (S)
	53206600	Control Switch Knob, small
	53206600	Control Switch Knob, big
	53106600	Output Level Volume Knob (B)
	53106410	Output Level Volume Knob (S)
	53105900	Rec Level Volume Knob
	53106100	R-CH (B)
	53106100	Rec Level Volume Knob
	53105810	R-CH (S)
	53105810	Rec Level Volume Knob, L-CH (B)
	53106010	Rec Level Volume Knob, L-CH (S)

Parts List <Top View>

Parts No.	Stock No.	Description
	38004700	Power Cord
	38100300	Strain Relief
	22005600	4P Line Terminal
	07526900	Belt (1), capstan
	07526800	Belt (2), take-up
	60302400	Belt (3), counter
	03614000	IC DNB638 for Auto Stop
IC701	70004500	Front Panel Ass'y (B)
	70004720	Front Panel Ass'y (S)
	50604700	Meter Cover
	52313810	Knob Guide
	71619000	Counter Window
	70003310	Function Switch Knob Ass'y (B)
	70003210	Function Switch Knob Ass'y (S)
	53301600	Sensul Mark (B)
	53301700	Sensul Mark (S)

Parts List <Side View>

Parts No.	Stock No.	Description
T701	40032800	Power Transformer
S701	11603100	Rec Sensor Switch
S703	11603100	Half Switch
SOL701	43402700	Plunger Solenoid, brake
SOL702	43402800	Plunger Solenoid, hold
SOL703	43402900	Plunger Solenoid, play
SOL704	43402500	Plunger Solenoid, rec
	43205200	Capstan Motor
	43201600	Reel Motor
G-1261	04322300	AC Fuse 2A 250V
F601	11312300	Power Switch
S601	00386000	0.01μF 50V C.C.
C601	65605000	Flexible Wire
	65017100	Spring (A), rec solenoid
	65017000	Spring (B), rec solenoid
	50003000	Bonnet (B)
	57402800	Bonnet (S)
	56073600	Leg
	56007100	Cushion Sheet, control switch

*Note:
 Since there are SC-5330 (Black Model) & SC-5300 (Silver Model) in the parts list above, please pay attention when ordering parts.
 Parts marked (B) in parts list for SC-5330 only
 Parts marked (S) in parts list for SC-5300 only

7-2. Control Section

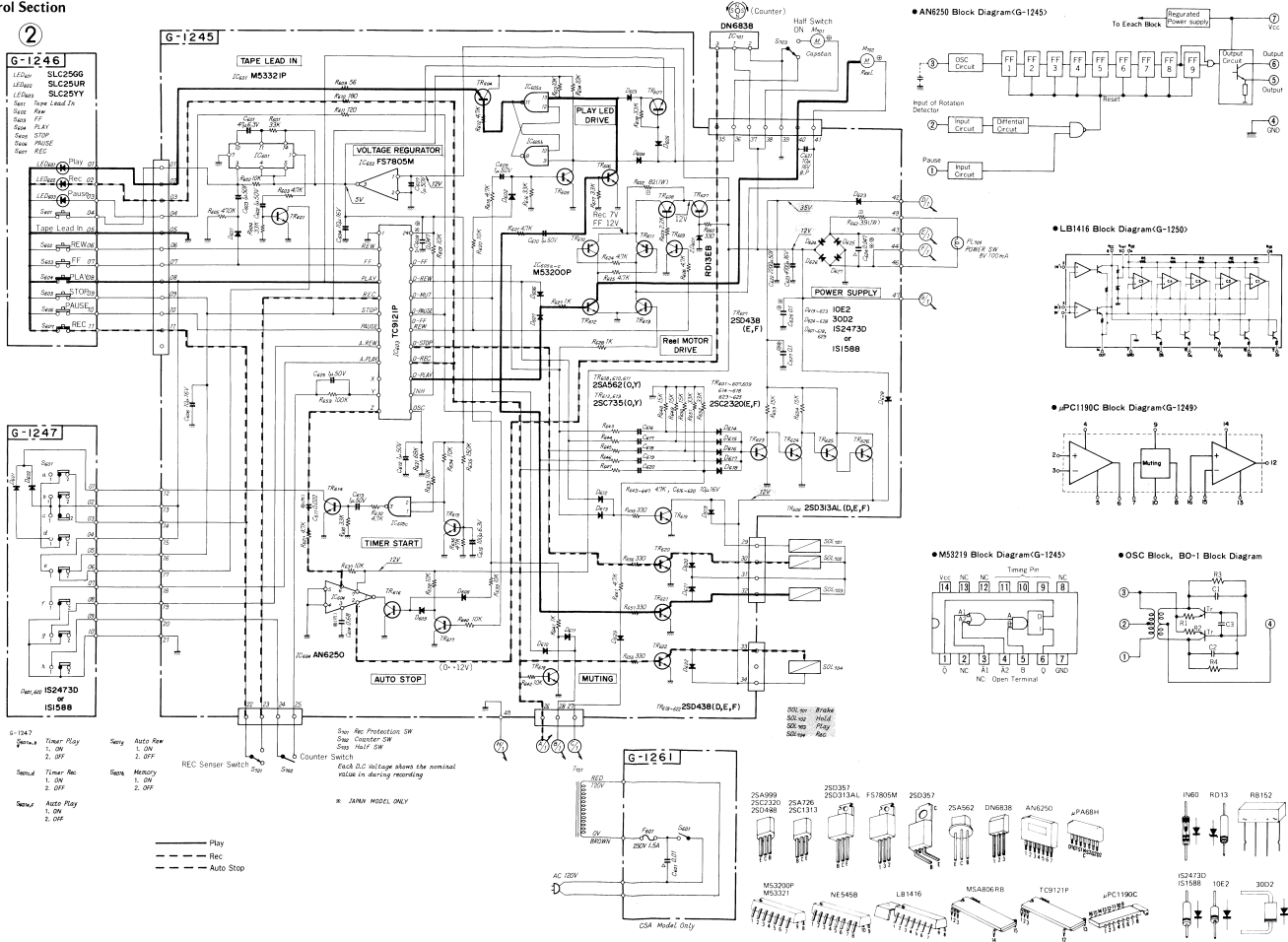

8. PARTS LOCATION & PARTS LIST

8-1. G-1245 Control Circuit Board (Stock No. 76301401)

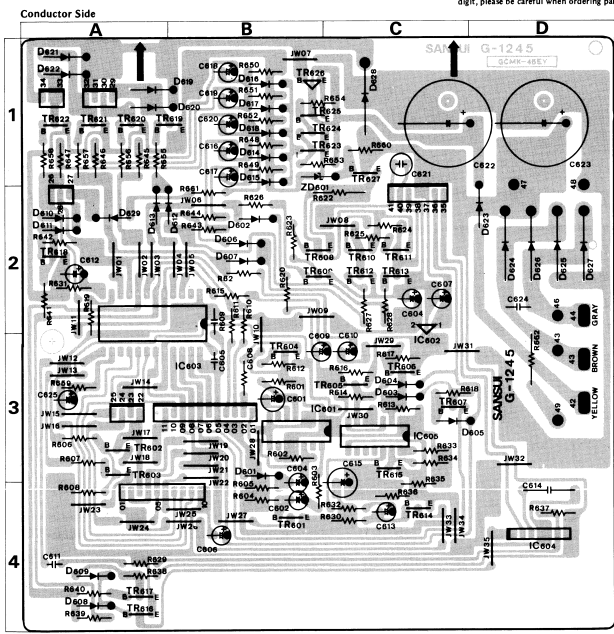

Parts No.	Stock No.	Description	Position	Parts No.	Stock No.	Description	Position	Parts No.	Stock No.	Description	Position
*Transistor				*Diode				R 622	00184800	82Ω 1W N.I.R.	2C
TR601	03 0306301	2SC2320 E, F	3A, AB	D 601	19 03111600	1S247D	2, 3B	R 662	00159000	30Ω 1W N.I.R.	3D
TR604	07 0306301	2SC2320 E, F	3B, C	D 619	23 03117000	1S1588	1A, 2D	C 614	00348800	0.68μF M.C.	4D
TR608	0300200	2SA462 O, Y	2B	D 624	28 03116300	30C2	1C, 2D	C 621	00343300	10μF 10V E.C. (BP)	1C
TR609	0306301	2SC2320 E, F	2B2	D 629	03111600	1S247D	2A	C 622	00382000	2200μF 50V E.C.	1C
TR610	011 0300200	2SA462 O, Y	2C	ZD601	03161300	RD13E8	1B, C	C 623	00380100	4700μF 25V E.C.	1D
TR612	013 0306300	2SC2320 E, F	2C								
TR614	18 0306301	2SC2320 E, F	3A, C								
TR619	22 0306300	2SD438 D, E	1A								
TR623	25 0306301	2SC2320 E, F	1B								
TR626	0306301	2SD313AL D, E	1B								

IC	Parts No.	Stock No.	Description	Position	IC	Parts No.	Stock No.	Description	Position
IC 601	03611000	M53231P	3B	E.L.	Low Leak Electrolytic Capacitor				
IC 602	03660000	F57855M	2A	E.B.	Bi-Polar Electrolytic Capacitor				
IC 603	03610000	TC9121P	2C	E.B.L.	Low Leak Bi-Polar Electrolytic Capacitor				
IC 604	03611000	AN-6250	4D	Ta.C.	Tantalum Capacitor				
IC 605	03611000	M53200P	3C	F.C.	Film Capacitor				

Abbreviations

C.R.	Carbon Resistor	E.L.	Low Leak Electrolytic Capacitor
S.R.	Solid Resistor	E.B.	Bi-Polar Electrolytic Capacitor
Ca.R.	Cement Resistor	E.B.L.	Low Leak Bi-Polar Electrolytic Capacitor
M.F.R.	Metal Film Resistor	Ta.C.	Tantalum Capacitor
F.R.	Fusing Resistor	F.C.	Film Capacitor
N.I.R.	Non-Inflammable Resistor	M.P.	Metalized Paper Capacitor
C.C.	Ceramic Capacitor	P.C.	Polyethylene Capacitor
C.T.	Ceramic Capacitor, Temperature Compensation	G.C.	Gimmick Capacitor
E.C.	Electrolytic Capacitor		

8-2. G-1249 Play & Rec Amp. Circuit Board (Stock No. 76201901)

Conductor Side

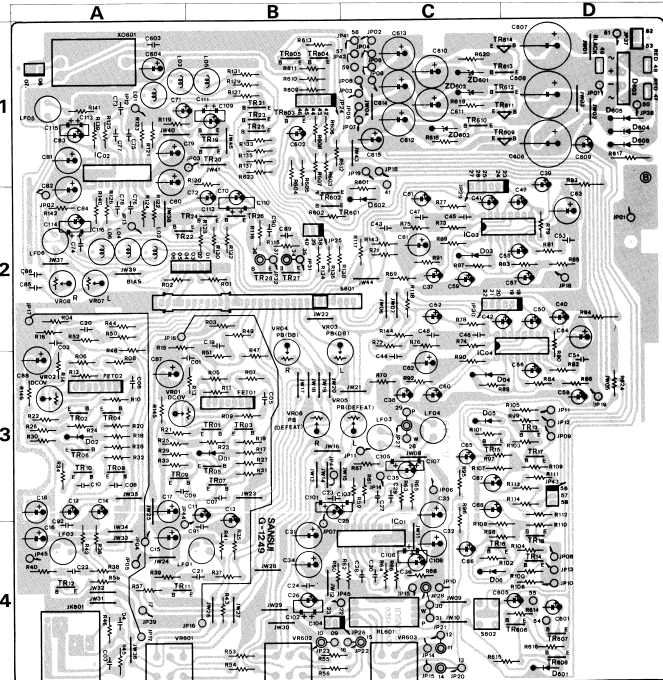

Parts No.	Stock No.	Description	Position	Parts No.	Stock No.	Description	Position	Parts No.	Stock No.	Description	Position
*Transistor				*Diode				R 622	00184800	82Ω 1W N.I.R.	2C
TR101	02 0306700	1 2SC1313 F, G	3B, 3A	D 601	19 03111600	1S247D	2, 3B	R 662	00159000	30Ω 1W N.I.R.	3D
TR103	04 0306700	1 2SC1313 F, G	3B, 3A	D 619	23 03117000	1S1588	1A, 2D	C 614	00348800	0.68μF M.C.	4D
TR105	06 0306700	1 2SA758F F, G	3B, 3A	D 624	28 03116300	30C2	1C, 2D	C 621	00343300	10μF 10V E.C. (BP)	1C
TR107	08 0306700	1 2SA758F F, G	3B, 3A	D 629	03111600	1S247D	2A	C 622	00382000	2200μF 50V E.C.	1C
TR110	10 0306801	2 2SC2320 E, F	3A	ZD601	03161300	RD13E8	1B, C	C 623	00380100	4700μF 25V E.C.	1D
TR112	0306801	2 2SC2320 E, F	3A								
TR114	0306801	2 2SC2320 E, F	3A, 4D								
TR115	16 0306801	2 2SC2320 E, F	3C, 4C								
TR117	18 0312700	2SA469E E, F	3D, 4D								
TR119	28 0306801	2 2SC2320 E, F	1B, 2A, 2B								
TR181	802 0306801	2 2SC2320 E, F	2B								
TR183	03012700	2SA499E E, F	1B								
TR184	0306801	2 2SC2320 E, F	1B, 4D								
TR189	0306801	2 2SC2320 E, F	1C								
TR190	0306801	2 2SC2320 E, F	1C								
TR191	0306801	2 2SC2320 E, F	1C								
TR192	0306801	2 2SC2320 E, F	1C								
TR193	03012700	2SA499E E, F	1D								
TR194	0306801	2 2SC2320 E, F	1D								
TR195	03034401	2 2SB527 D, E	1D								

IC	Parts No.	Stock No.	Description	Position	IC	Parts No.	Stock No.	Description	Position
IC 601	03611000	M53231P	3B	E.L.	Low Leak Electrolytic Capacitor				
IC 602	03660000	F57855M	2A	E.B.	Bi-Polar Electrolytic Capacitor				
IC 603	03610000	TC9121P	2C	E.B.L.	Low Leak Bi-Polar Electrolytic Capacitor				
IC 604	03611000	AN-6250	4D	Ta.C.	Tantalum Capacitor				
IC 605	03611000	M53200P	3C	F.C.	Film Capacitor				

Abbreviations

C.R.	Carbon Resistor	E.L.	Low Leak Electrolytic Capacitor
S.R.	Solid Resistor	E.B.	Bi-Polar Electrolytic Capacitor
Ca.R.	Cement Resistor	E.B.L.	Low Leak Bi-Polar Electrolytic Capacitor
M.F.R.	Metal Film Resistor	Ta.C.	Tantalum Capacitor
F.R.	Fusing Resistor	F.C.	Film Capacitor
N.I.R.	Non-Inflammable Resistor	M.P.	Metalized Paper Capacitor
C.C.	Ceramic Capacitor	P.C.	Polyethylene Capacitor
C.T.	Ceramic Capacitor, Temperature Compensation	G.C.	Gimmick Capacitor
E.C.	Electrolytic Capacitor		

8-3. G-1250 Peak Indicator & VU Meter Circuit Board (Stock No. 76909301)

Conductor Side

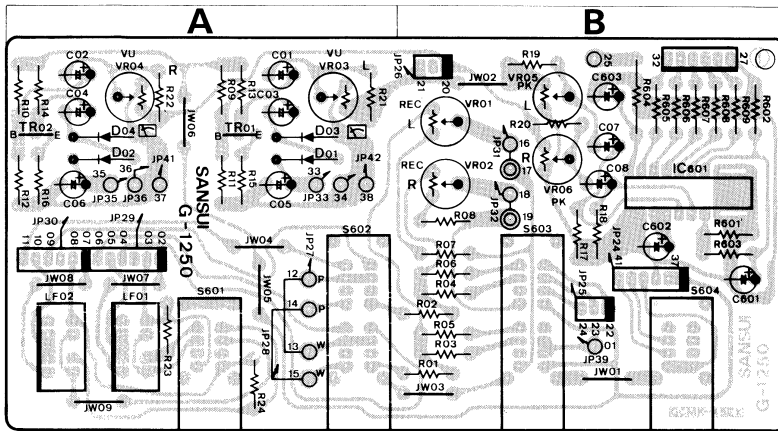

Parts List

Parts No.	Stock No.	Description	Position
● Transistor			
TR01, 02	03068801, 2	2SC2320 E, F	A
● IC			
IC 601	03611600	LB1416	B
● Diode			
D 01 ~ 04	03117800	1N60	A
LF 01, 02	09106300	BL-30HA MPX Filter	A
VR01, 02	10351500	22kΩB Rec Level Volume	B
VR03, 04	10351900	100kΩB VU Meter Volume	A
S 601	11720800	MPX Filter Switch	A
S 602	11721100	Dolby NR Switch	A
S 603	11721200	EQ Switch	B
S 604	11721000	Bias Switch	B

●The circuit boards, G-1246 & G-1247 are not supplied as the assembled, the individual parts on the circuit boards, however are provided for orders.

8-4. G-1246 Control Switch Circuit Board

Conductor Side

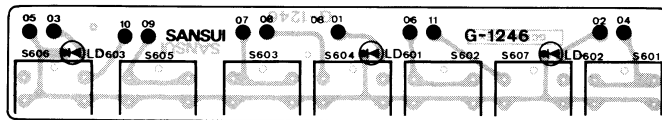

Parts List

Parts No.	Stock No.	Description
LD601	03194000	LED, Play Indicator
LD602	03193800	LED, Rec Indicator
LD603	03193900	LED, Pause Indicator
S 601 ~ 07	11907000	SCM81102, Control Switch

8-5. G-1247 Control Side Circuit Board

Conductor Side

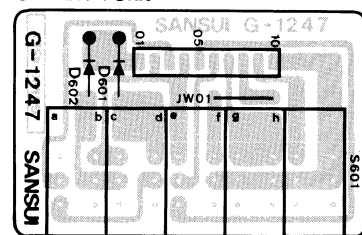

Parts List

Parts No.	Stock No.	Description
● Diode		
D 601	03111600	1S2473D
	03111800	1S1588
S 601	11319700	Timer Play, Timer Rec, Auto Play Memory, Auto Rew

8-6. G-1253 Peak Indicator Circuit Board

Parts List

Parts No.	Stock No.	Description
● LED		
D 601, 602	03193300	GL-9NG9, green
D 603	03193400	GL-9HY9, yellow
D 604, 605	03193200	GL-9PR9, red

9. PACKING LIST

Parts No.	Stock No.	Description
1	91166910	Vinyl Cover
2	90301900	Styrofoam Packing (B)
	90301800	Styrofoam Packing (S)
3	07519700	Carton Case (B)
	07519600	Carton Case (S)

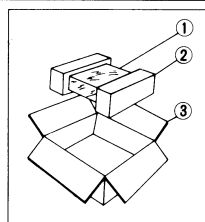

10. ACCESSORY PARTS LIST

Stock No.	Description
92053500	Operating Instructions . . (B)
92053200	Operating Instructions . . (S)
38103300	Input-Output Cord
92303300	Schematic Diagram
94300500	Head Cleaner (cotton buds)
72964000	Rack Mounting Adaptor . (B)

●Note:

Since there are SC-5330 (Black Model) & SC-5300 (Silver Model) in the parts list above, please pay attention when ordering parts.
 Parts marked (B) in parts list for SC-5330 only
 Parts marked (S) in parts list for SC-5300 only