

OPERATING INSTRUCTIONS & SERVICE MANUAL

SOLID-STATE AM /FM MULTIPLEX STEREO TUNER AMPLIFIER

SANSUI MODEL TR-707A



Sansui

SANSUI ELECTRIC COMPANY LIMITED

SANSUI

SOLID-STATE
AM/FM MULTIPLEX
STEREO TUNER
AMPLIFIER



MODEL
TR-707A

FEATURES	4
SPECIFICATIONS	5
CHARACTERISTICS.....	5
CONNECTIONS	6, 7
SWITCHES AND KNOBS	8, 9
OPERATIONS	10, 11
GENERAL NOTICE	12, 13
SERVICE NOTE	14, 15, 16
PARTS LIST	17, 18, 19, 20, 21
ALIGNMENT	22, 23
PARTS LAYOUT.....	24
SCHEMATIC DIAGRAM	25, 26
REMOVALS DISASSEMBLE	27



Come within earshot of this new all-transistorized stereo receiver and your search is over. The Sansui TR-707A may not look as imposing as the vacuum tube sets, but that's because the solid-state system lets it be more compact. And the sound—what stereo is naturally all about—would lead you to believe you're listening to studio equipment.

The TR-707A has a 3-gang variable condenser that's been adopted for both FM and AM. The result is a vast improvement in sensitivity and image ratio. The extra-large tuning meter takes the guesswork out of station selection, too.

Read this instruction carefully before you use the amplifier for the first time.

Output? 50 watts total. And the power bandwidth is so wide that it ranges from 32 cps. all the way to 25,000 cps. Every sound, high or low, is reproduced in full scope—like the aforementioned studio equipment.

In short, the Sansui TR-707A gives you first-rate stereo from every angle. And it looks a lot more expensive than it really is.

FEATURES

SPECIFICATIONS

CHARACTERISTICS

FEATURES

✦Adoption of the (solid state) and OTL circuit system has made it more compact and smaller in the dimensions and weight as compared with the vacuum-tube type, resulting in attaining a higher performance.

✦Adoption of the OTL system for the output circuit and the Mesa type silicon transistor 2SC245 for output has made it possible to yield clear and crisp low sounds of large damping factor with an output of music power — 50 watts total.

✦Power bandwidth is so wide as ranging from 32 cps. to 25,000 cps, making it possible to reproduce sound in full scope.

✦The new circuit system adopting the driver type transformer (Utility Model Applied For) has been used for the main amplifier, resulting in attaining a high stability in temperature characteristics and the short-circuit of the output terminal.

✦4 transistors of ultra-accurate class free of hums and noises have been adopted for the pre-amplifier part. It is a trouble-free circuit of high stability. With full confidence, we can recommend other circuits too like the pre-amplifier which has already been

adopted for more than 100,000 units.

✦The adoption of the most advanced switching matrix method for the multiplex circuit has amazingly improved the performance of the TR-707A amplifier. The amplifier has a full fledged AFC enables you to enjoy a stabilized reception of FM broadcast for many hours once you have tuned in.

✦The FM multiplex stereo indicator actuated helps you tune in FM stereo stations easily and reliably.

✦Muting Switch suppresses noise during channel selection.

Unlike conventional FM receivers, which produce loud noise in the absence of input because their limiters require a certain level of input voltage to perform their noiselimiting function, the TR-707A produces no noise even when not tuned in any station. This is because it has a built-in "Muting switch" (squelch circuit) which disconnects the audio amplifier stage automatically when tuner input drops below a certain level.

✦The TR-707A amplifier has an output terminal for the center-channel amplifier. Connect it to a monaural amplifier to produce a three dimensional effect.

✦Each channel has independent tone controls for bass and treble. This makes fine adjustment possible.

✦The built-in, high sensitivity ferrite antenna adds to your listening pleasure by reducing noise to less than that of conventional tuners.

✦The 3-gang variable condenser has been adopted for all FM and AM resulting in the improvement of sensitivity and image ratio.

✦Adoption of the large-type tuning meter has made it more correct to select a channel and easier to see.

✦This amplifier is equipped with various advanced accessory circuits such as loudness control, low and high filters, tape monitor, and headphone jack.



SPECIFICATIONS

POWER AMPLIFIER CHARACTERISTICS

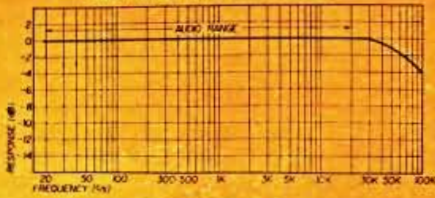

POWER OUTPUT HARMONIC DISTORTIONS

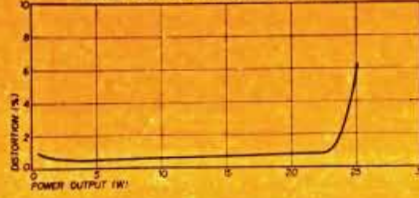

TONE CONTROL CHARACTERISTICS

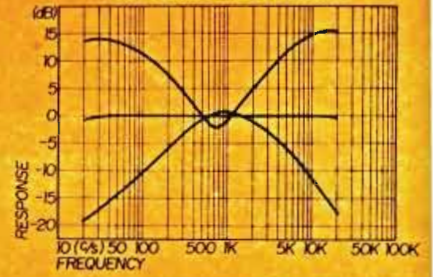

FM RATIO DETECTOR RESPONSE

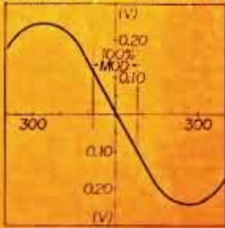

FM IF CHARACTERISTICS

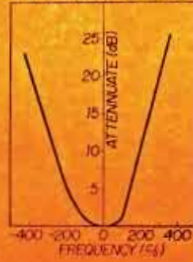

LOUDNESS CONTROL CHARACTERISTICS

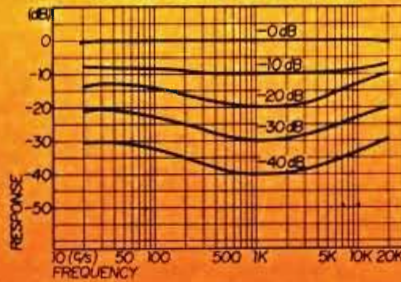

LOW CUT, HIGH CUT FILTER CHARACTERISTICS

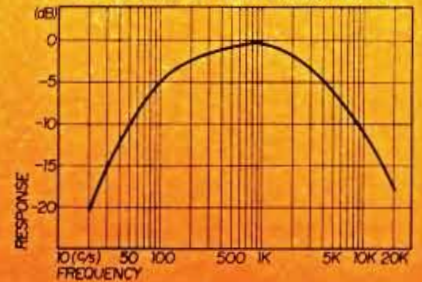

TECHNICAL SPECIFICATIONS

AUDIO SECTION

* POWER OUTPUT

Music Power (IHFM) 50 watts total

CONTINUOUS power Left/Right:

23/23 Watts (1% harmonic distortion)

RMS STEREO Power (both channel driven) 18 watts x 2

Harmonic Distortion:

1% at 1000cps under RMS rated power

Power Bandwidth (IHFM):

32~25,000 cps

Frequency Response

over-all: 20~20,000 cps ± 1 dB

* Channel Separation:

PHONO 50 dB at 1,000 cps

AUX 51 dB at 1,000 cps

* Hum and Noise:

PHONO (IHFM) less than 70 dB

AUX (IHFM) less than 70 dB

Output Impedance 8~32 Ω

* Input Sensitivity (for rated output)

PHONO (MAG): 2.4 mv

TAPE HEAD: 2 mv

MIC: 2.3 mv

AUX: 360 mv

* Center Channel Output

4.4v (for rated output)

Equalizer

PHONO (MAG): RIAA

TAPE HEAD: NAB

* Controls and Switches

Bass controls: 27 dB total variation

at 50 cps

Treble controls: 22 dB total variation

at 10,000 cps

Loudness control 50 cps + 10 dB

10,000 cps + 10 dB

(Volume control at -30 dB)

Low filter: -10 dB at 50 cps

High filter: -11 dB at 10,000 cps

Mode switch:

1. Stereo Rev. 2. Stereo Nor.

3. Mono L+R 4. Mono L

5. Mono R

Function switch:

1. Tuner 2. Phono 3. Tape head

4. Mic 5. AUX

* Other Special Features

Direct tape monitor, Head phone jack, Center channel output for connection to third amplifier. DIN connector.

FM SECTION

Frequency Range: 88~108 MC

* **Sensitivity:** 2.5 μ V ± 3 dB (IHFM standard)

1.8 μ V ± 3 dB (S/N 20dB)

IF selectivity: 250 KC - 3 dB

FM Stereo channel separation:

35dB at 1,000 cps

FM Stereo Distortion: less than 1%

FM Stereo Frequency Response:

50~15,000 cps ± 1.5 dB

AM SECTION

Frequency Range: 535 KC~1605 KC

IF-selectivity: 6 KC - 3dB

Sensitivity: 15 μ V (IHFM standard)

IF Frequency: 455 KC

Other Special Features

Muting, Tuning meter, FM stereo indicator, Heavy flywheel tuning, Solid state AFC.

TRANSISTORS AND DIODES

Transistors: 2SA235 x 1, 2SA435 x 2, 2SA70 x 4, 2SA102 x 2, 2SA101 x 2, 2SA49 x 3, 2SB54 x 4, 2SB202 x 1, 2SC372 x 1, 2SB381 x 8, 2SB378A x 6, 2SC292 x 2, 2SC245 x 4

Diodes: OA-79 x 11, IS352 x 1, SE-1.5a x 2, SW-0.5a x 3, 1N60 x 4

POWER REQUIREMENTS

Power Voltage: 100, 117, 220, 240 volts
50, 60 cps

Power Consumption 90 VA

DIMENSIONS

WIDTH: 17 $\frac{3}{8}$ "

HIGHT: 5 $\frac{1}{2}$ " (Excluding rubber stand)

DEPTH: 14 $\frac{3}{16}$ " (Excluding knobs)

WEIGHT: 33.1 lbs.

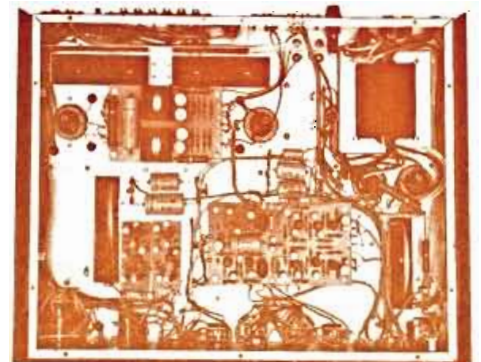

CONNECTIONS

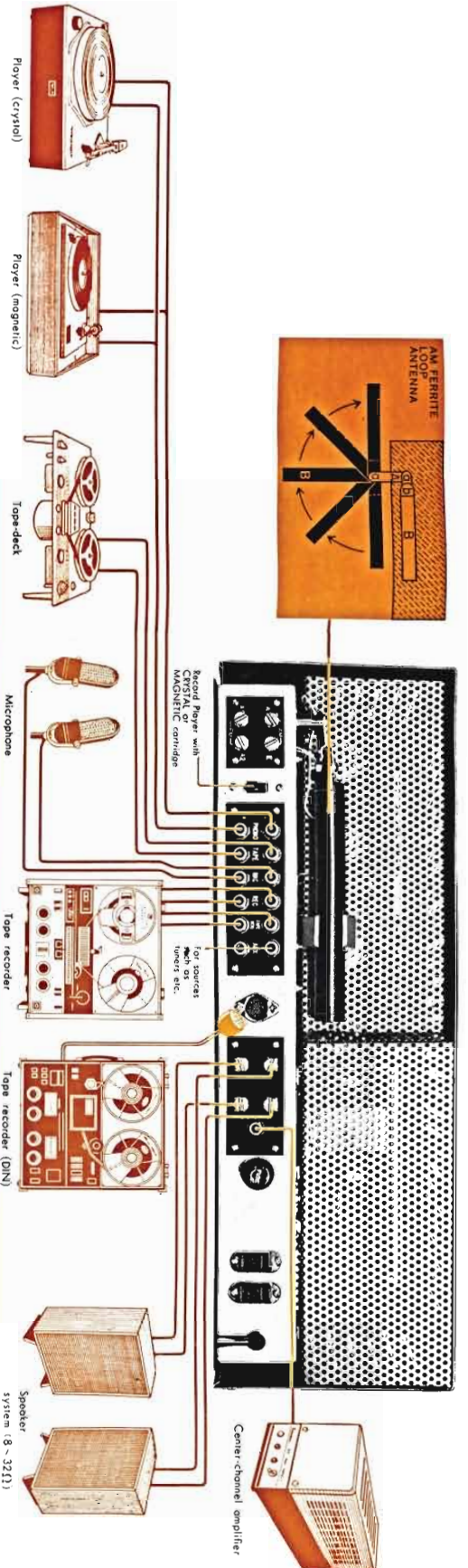

RECORD PLAYER

Connect the left output of player to the "CHAN.L" on the "PHONO" input terminals on the back of the amplifier. Connect the right output of player "CHAN.R" to the "PHONO" input terminals or the back of amplifier. Set the cartridge switch on the back of the amplifier to "MAG" or "X-TAL" according to the type of your cartridge. Connect the power-cord plug of the player to the power-pug receptacle on the back of the amplifier.

MICROPHONE

You can use a microphone with this TR-707A amplifier. Any high-impedance (50-Kilo-ohm) crystal, dynamic or velocity microphone is acceptable.

Connection: Connect the microphone to L or R of the "MIC" terminal on the back of the amplifier. When you use two microphones, connect one to L and the other to R.

TAPE RECORDER

This amplifier can be used with a tape recorder for recording and playback and can also play tapes on the tape-deck. If you use a three-head tape recorder which has separate record and playback

heads, you can make recordings while listening to a reproduction of the recordings. In other words, this amplifier can be used as a monitor which lets you know the quality of your recordings while they are being made.

1. Single-connection tape recorder. Single-connection tape recorder (DIN standard) connect the single-connection connector to the "TAP-REC" plug on the back of the amplifier.
2. Pin-lock tape recorder.
 - a. Recording: Connect the tape recorder input terminals to L and R (L or R in the case of monaural operation) of the "REC" terminals on the back of the amplifier with shielded wire.
 - b. Playback: Connect the tape recorder output terminals ("LINE") to L and R (L or R in the case of monaural operation) of the "TAP MON" terminals on the back of amplifier.
3. playing tapes on the tape deck.
 - a. Connect the tape deck output terminals to L and R (L or R in the case of monaural operation) of the "TAP" terminals on the back of the amplifier.

ANTENNA

Connection of FM Antenna

Connect the attached FM antenna (feeders) to the A₁ and A₂ terminals. If you live in an area near broadcasting stations, install the antenna indoors in a T shape, choosing its direction so that it brings in broadcasts most effectively. Be careful of the direction and height of the antenna, because input varies considerably.

When you use this amplifier in a ferro-concrete building or in an area far from stations, the signals become weak and noise strong. In such a case, use an outdoor television antenna or, if possible, an antenna exclusively for FM reception. FM sensitivity cannot be increased simply by lengthening the antenna wire. Adjust the height and direction of the antenna while listening to an FM program so that it ensures maximum sensitivity.

Built-in AM Antenna

To receive AM broadcasts, use the built-in



SPEAKERS

Connect (+) of the left-hand speaker to the 8-32 ohm terminal of the upper L terminals on the back of the amplifier. Connect (-) of the left-hand speaker to (C) of the upper L terminals. Connect (+) of the right-hand speaker to the 8-32 ohm terminal of the lower R terminals on the back of the amplifier. Connect (-) of the right-hand speaker to (C) of the lower R terminals.

Connection of AM Antenna

When you use the amplifier in a ferro-concrete building or in an area far from stations, the signals become weak and noise stronger. In such a case, use an outdoor antenna built slightly apart from the wall of your house. At the same time, ground the tuner. The direction of the antenna affects tuner sensitivity. Install it in such a way that it can receive broadcasts most effectively. When you use an outdoor antenna, be sure to equip it with a lightning arresting switch to avoid possible danger.



SPEAKERS

Connect (+) of the left-hand speaker to the 8-32 ohm terminal of the upper L terminals on the back of the amplifier. Connect (-) of the left-hand speaker to (C) of the upper L terminals. Connect (+) of the right-hand speaker to the 8-32 ohm terminal of the lower R terminals on the back of the amplifier. Connect (-) of the right-hand speaker to (C) of the lower R terminals.

Connection of AM Antenna

This amplifier is equipped with a terminal for a center-channel amplifier so that it can be used for three-dimensional reproduction. To do this, connect the input terminal of a monaural amplifier (either a main or combination amplifier can be used) to the center-channel out-put terminal. The center-channel mixes the right and left sounds to produce the three-dimensional effect.

* If you find that the sounds from both speakers do not mix well, but leave a short of vacuum midway between the speakers, you can conclude that the amplifier and the speakers do not match in polarity. In such a case, reverse the (+) and (-) connections of either speaker.

SPEAKERS

* When you use two sets of speakers for stereophonic reproduction, make sure that the speaker output-terminal connections do not cause contact between L and R and that the terminals are connected properly. If the connections are faulty, your amplifier will not work normally and may also go out of order.

SWITCHES AND KNOBS

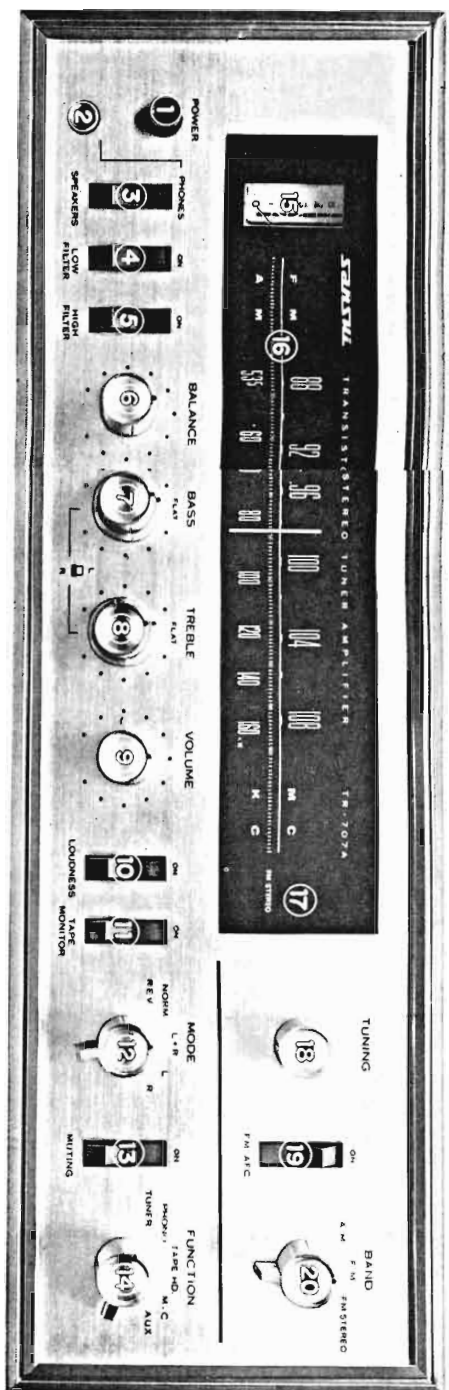

① POWER

This switch is used for connecting and disconnecting the power supply. Push the button for power. Push it again to shut it off. The switch also activates and deactivates the power supply plug receptacles on the back of the amplifier.

② HEADPHONE JACK

When you want to avoid disturbing others or when you use the amplifier as a monitor, connect the headphone to this jack. You can still enjoy stereophonic reproduction through the headphones. For this purpose, you can use any kind of headphones or earphones if its plug fits into the jack. But use dynamic headphones designed for stereophonic reproduction, if possible.

③ SPEAKER

When listening with headphones speaker sound may be eliminated by moving the speaker switch to the phones position.

④ LOW FILTER

For eliminating very low-frequency noises, such as those produced by phono turntable or tape deck.

⑤ HIGH FILTER

For eliminating annoying noises produced by record scratch, radio static, whistle and other interferences.

⑥ BALANCE

This knob is used to adjust the balance of volume between the right and left speakers for the best stereophonic effect. Make the adjustment while listening to the sound of both speakers. When the amplifier is adjusted properly, you feel as if the sounds come from a point midway between the two speakers.

⑦ BASS AND

⑧ TREBLE FOR "L" AND "R" SPEAKERS

These knobs control the tone of L and R speakers and each channel's bass and treble can be operated independently. Turn it clockwise for louder reproduction and to reduce, turn it counterclockwise. The knobs outside is control for the right side speaker and inside knobs are controls for the left side speaker.

⑨ VOLUME

Output power from the amplifier is adjusted with this control.

⑩ LOUDNESS

When sound volume is at a low level, you feel as if bass and treble were missing. In such a case, turn this switch "ON" to compensate bass and treble. This will make you feel as if you were present at an actual concert.

⑪ TAPE MONITOR

When switched on, sound being recorded through a three-head tape recorder can be played back through the amplifier. This switch should be on only when playing back from a tape recorder. While the tape is being recorded, it is possible to listen to the program and monitor the recording at the same time. When not recording, set to off.

⑫ MODE

NORM: Signals from L and R are reproduced by L and R speakers respectively.
REV: Reverses Speakers. Signals from L and R reproduced by each speakers. L+R: Mixed L and R sounds from both speakers.
L: (For Monaural phono or Tape) Signals from L will be reproduced by L and R speakers at the same time. (R input not operative)
R: (For Monaural phono or Tape) Signals from R will be reproduced by L and R speakers at the same time. (L input not operative)

MODE SWITCH	⑫	⑬	⑭	⑮	⑯	⑰	⑱	⑲	⑳
STEREO	ON	ON	ON	ON	ON	ON	ON	ON	ON
MONO	OFF	OFF	OFF	OFF	OFF	OFF	OFF	OFF	OFF
REV	OFF	ON	OFF	OFF	OFF	OFF	OFF	OFF	OFF
MONO	OFF	OFF	ON	OFF	OFF	OFF	OFF	OFF	OFF
MONO	OFF	OFF	OFF	ON	OFF	OFF	OFF	OFF	OFF
MONO	OFF	OFF	OFF	OFF	ON	OFF	OFF	OFF	OFF
MONO	OFF	OFF	OFF	OFF	OFF	ON	OFF	OFF	OFF
MONO	OFF	OFF	OFF	OFF	OFF	OFF	ON	OFF	OFF
MONO	OFF	OFF	OFF	OFF	OFF	OFF	OFF	ON	OFF

⑬ MUTING

Turn this switch on to eliminate the noise you hear when not tuned in any station. Keep it on while tuning. However, if the muting switch is kept on when you receive weak signals, the sound may be distorted or reception may become impossible. In such a case, switch off the muting circuit.

⑭ FUNCTION

TUNER: For AM FM radio reception.
PHONO: For turntable equipped.
TAPE H.D.: For input from tape deck.
MIC: For microphone.
AUX: For input from external circuit.

⑮ TUNING METER

When tuning in the station of your choice set the dial pointer to the position which results in a maximum indication on the tuning meter.

⑯ DIAL SCALE

⑰ FM MULTIPLEX STEREO INDICATOR

When the tuner receives signals from an FM station broadcasting multiplex, this indicator lights up to show that it is receiving a stereo broadcast. The indicator never lights when the tuner is receiving a monaural FM broadcast.

⑱ TUNING

For tuning FM and AM broadcasts, rotate tuning knob to select desired station on FM or AM dialscale while observing the tuning meter for the point of best reception.

⑲ FM-AFC

This prevents signals from FM station with drifting. This is likely to happen because of the very high frequencies used. If it occurs, the total quality deteriorates or you cannot hear the program at all. To avoid this, switch on the FM-AFC after tuning in the station of your choice. If you switch on the FM-AFC before tuning, you may not be able to tune the tuner as accurately. If the FM-AFC is kept on even when there are a number of stations nearby, you may suffer from their interference. In such a case, switch off the FM-AFC.

⑳ BAND

AM: For listening to AM broadcasts.
FM: For listening to FM broadcasts.
FM STEREO: For listening to FM stereo broadcast.

OPERATIONS

RECORD PLAYER OPERATION

1. Set the "FUNCTION" switch to "PHONO".
 2. Set the "MODE" switch to "NORM" or "REV" (to L or R in case of monaural operation).
 3. Switch on the player, put on the record and adjust the number of revolutions as necessary before placing the pickup on the record.
 4. Balance the sound from both speakers by means of the "BALANCE" knob.
 5. Adjust the amount of sound by means of the "VOLUME" knob. Other adjusting knobs and switches can be used to get the most satisfactory reproduction.
- * When you play a monaural record on a stereo record player, follow the same procedure as for stereo records. This will give you better results.
- * If you feel that left and right are reversed when playing a stereo record, turn the "MODE" switch to "REV".
- * To balance the sounds from both speakers, play a monaural record in the same way as a stereo record and adjust the "BALANCE" knob in such a way that you feel that the sound comes from a point midway between the right and left speakers.

TAPE RECORDER OPERATION

Recording

1. Set the "FUNCTION" switch at the proper position according to the program source (broadcast or record) you are going to record.
2. Set the "MODE" switch to "NORM" or "REV" (for stereophonic recording). "L+R" (for monaural recording of a stereophonic source).
3. Prepare the tape recorder for recording.
4. Operate the recorder and amplifier adjusting knobs and switches properly.

Playback

1. a. Tape deck
Set the "FUNCTION" switch at "TAPE HD".
b. Tape recorder
Set the "TAPE MONITOR" switch to "ON".
2. Set the "MODE" switch at "NORM" or "REV" (for stereo), at "L" or "R" (for monaural), or to "L+R" (for double track monaural).
3. Set the tape recorder in the play position.
4. Other adjusting knobs and switches can be used for the most satisfactory reproduction.

Tapemonitoring

To use your amplifier as a monitor for a threehead tape recorder, follow the same procedure as the one for playing tapes on a recorder. When you use a recorder, read the instruction manual carefully to avoid error in connection and operation. Unless you use your amplifier as a tape recorder, be sure to switch off the "TAPE MONITOR" switch. Connecting tape recorder can be done using either a signal connection connector or by a pinjack. The signal-connection plug conforms with German DIN standard specifications. It makes it easier to connect the tape recorder to your amplifier because it has a fivepin plug for both recording and playback.

MICROPHONE OPERATION

1. Set the "FUNCTION" switch to "MIC".
2. Set the "MODE" switch to "NORM" or "REV" (when you use two microphones for stereophonic effect).
At "L" or "R" (when you use only one microphone for monaural reproduction), or to "L+R" (when you use mix two different program sources from two microphones).
3. Other adjusting knobs and switches can be used for the most satisfactory reproduction.

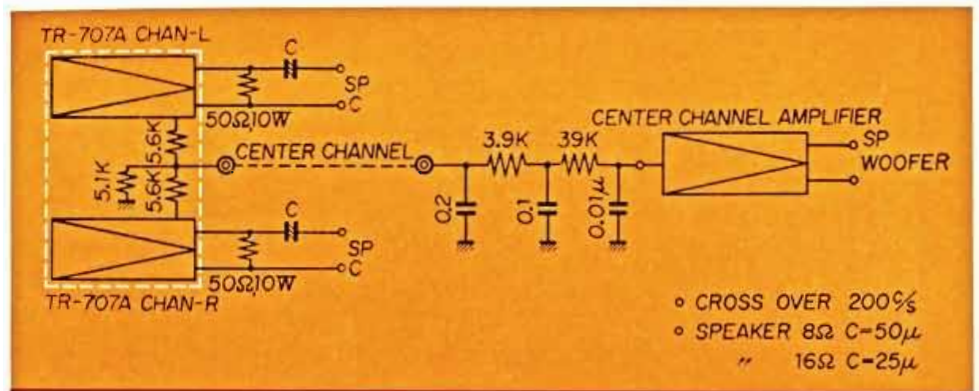

This amplifier accepts only high-impedance microphones. You cannot get the best performance if you use too long a microphone cord, which causes various problems and reduces treble. This amplifier has separate tone controls for right and left speakers. You will find this feature very useful when you use one microphone for music and another for voice. Further, it gives added versatility to your amplifier, particularly when you record on tape what is picked up by microphones.

BROADCASTING RECEPTION

A. FM broadcast reception :

1. Set the "FUNCTION" switch to "TUNER" (lamp lights on tuning meter).
2. Set the "BAND" switch to "FM".
3. Set the FM-AFC switch to OFF.
4. Tune in the station of your choice by means of "TUNING" knob using the dial and the Tuning Meter.
5. "MUTING" switch on, if the noise has during channel selection.
6. When you finished channel selection FM-AFC switch at on.
7. Use other switches according to your need.

B. AM broadcast reception :

1. Set the "FUNCTION" switch at "TUNER".

2. Set the "BAND" switch to "AM".
 3. Tune in the station of your choice by means of "TUNING" knob using the dial and the Tuning Meter.
 4. Use other switches according to your need.
- C. FM MPX stereo reception :
1. Set the "FUNCTION" switch at "TUNER".
 2. Set the "BAND" switch to "FM STEREO"
 3. Set the "MODE" switch to "NORM" or "REV".
 4. Tune in the station of your choice by means of "TUNING" knob using the dial and Tuning Meter. The moment you are tuned to an FM stereo station, the FM Stereo Indicator lights up.
 5. The "TUNING" knob and "FM-AFC" switch are operated same of FM broadcast reception.
 6. Make the balance for the sound of right and left speakers by the "BALANCE" knob.
 7. Use other switches according to you need.

SPECIAL OPERATION

This TR-707A amplifier has an out-put terminal for the center channel amplifier.

The center channel mixes the left and right sounds to produce the three-dimensional effect. Connect it to monaural amplifier to produce a three-dimensional effect. To do this, connect the input terminal of the center-channel amplifier (monaural amplifier) to the pin-jack of the center-channel output terminal at the right of the speaker terminal board with shieldwire. Connections are as the following figure.

GENERAL NOTICE

HOW TO ELIMINATE NOISE

●AM Broadcast Reception

Noise during AM broadcast reception can often be eliminated just by changing the position of the antenna.

In a area far from a station or in the mountains where radio waves cannot reach easily, or in a ferroconcrete building or a block of such buildings, the waves are not received well, resulting in unstable reception and creased noise. In such a case, connect a vinyl wire to the AM antenna terminal and stretch it along a pillar, lintel or ceiling in such a way that the signals come in best. If this does not reduce noise or improve sensitivity, erect an antenna outside the building, slightly apart from wall.

In addition, some noise is peculiar to a certain broadcasting frequency. These result from the nature of AM waves. In some cases, they can be eliminated by grounding the amplifier or reversing the power cord plug-receptacle connections.

●FM Broadcast Reception

Noise during FM broadcast reception can be generally attributed to either of these: insufficient antenna input or interference from other electrical appliances.

Antenna input is insufficient when the antenna is not installed properly or when the station is far away. Extend and fix the attached antenna in such a position that noise is minimized and the antenna input is maximized.

If this does not prove effective, use an indoor television antenna. For better results, erect an outdoor television or, if possible, an exclusive FM antenna in such a position that you can receive the broadcast most effectively.

when you use a television antenna for both television and FM with the help of a divider, make sure that television reception is not affected.

To prevent noise, avoid using an unnecessary long antenna wire.

FM reception is affected considerably by the conditions of transmission by stations: power and antenna efficiency. As a result, you may receive one station quite well while having difficulty in receiving another station.

●Common to AM and FM

In an area occupied by many ferroconcrete buildings, you may notice noise which occurs at a particular time of a day. This type of noise can be easily distinguished from those described above. To eliminate such noise, attach a noise arrester to the electrical appliance which causes it, or attach the arrester to the power source of your amplifier.

●Monophonic Reception of FM Multiplex Stereo Broadcasts

When you are tuned to an FM multiplex program, you may notice a noise which does not accompany monaural FM broadcasts. This does not mean that your tuner is out of order. In such a case, turn on the high filter. In some cases, you can



eliminate the noise by setting the treble knob of the amplifier flat or lower.

When you receive FM multiplex stereo broadcasts monophonically—with the selector at "FM"—the sounds from both speakers mix into a monaural reproduction as if you were tuned to an ordinary monaural FM station. Use this method if you find too much noise when receiving an FM multiplex stereo broadcast because the waves, field intensity or input is inadequate.

GROUNDING THE AMPLIFIER

Noise can sometimes be reduced by grounding the amplifier. To do this, connect the "E" terminal on the antenna terminal board on the back of your amplifier to a copper rod or plate buried deep in the ground. Use a vinyl or enamel wire to make the connections.

CONNECTIONS

When you connect your amplifier to a tape recorder or tuner, be sure to use an adequately thick shieldwire. If you use an untwisted vinyl cord like those used for lights, you will suffer from hum. Furthermore, do not use wire longer than 2 meters (about 6.5 ft.) because the longer the connecting wire is, the greater the attenuation of treble becomes. For connections to a tuner or FM adaptor, use a wire 1 to 1.5 meters (about 3.3 to 4.8 ft.) long. When you use the amplifier for monaural repro-

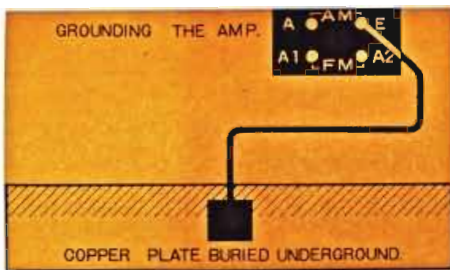

duction, it is easier for operation to use the upper L terminal for connection. Be sure to set the "MODE" switch to the connected channel.

HUM AND HOWLING

When you play a record or tape, you may sometimes hear unpleasant humming or howling. This does not mean that your amplifier is defective. In most cases, humming or howling is a result of these causes: If you place a record player on or near the speaker box, the vibrations of the speaker cabinet caused by the sound waves from the speaker are transmitted to the player and cause howling. To prevent this, keep the record player away from the speaker cabinet or put a thick cushion between the player and the cabinet.

A low buzzing sound will also be produced if you do not use shieldwire for connection. If this is not the cause, examine the connections closely. Make sure that the earth and live ends are not reversed so that the motor and arm are inadequately grounded.

SPEAKER POLARITY

If the phase (polarity viz. + and -) of the right and left speakers is not correct, sounds at the center of the frequency range become weak. You will particularly sense an attenuation of bass. To make sure that speaker polarity is all right, play a monaural record on a stereo record player. If the polarity is reversed you will have the result mentioned above. In such a case, reverse the polarity of either

speaker. (Connect to + the leadwire to +) When both speakers are thus made to agree in polarity, you will feel as if the sound come out of a single speaker placed midway between the right and left speakers.

REPLACING FUSES

a). Power Fuse—To protect against line surges and other adverse conditions sometimes encountered by electronic equipment, the TR-707A is fused at strategic locations. In case the lamp of the dial scale should not be lighted when the power switch turned on, or in case it should not work even if the respective buttons of the amplifier are operated, generally speaking, the fuse has blown. In case the fuse has blown, remove the power cord of the amplifier from the plug socket and replace the backside fuse by the glass-tubed 2A one which is the same in capacity as that blown. Be sure not to use a piece of fine wire as a stop-gap measure or a fuse with the different capacity. If used, it will causes the damage of the amplifier. It should not work as it ought to or the fuse should blow at once after replacement, the amplifier has been damaged. In this case, replace the fuse after repairing the amplifier upon confirming the cause of the damage of the amplifier.

In case of replacement of the speaker fuse, turn off the power switch, remove the bonnet cover of the amplifier and replace it by the attached speaker fuse.

b). Speaker Fuses—If the dial is lit, yet the set does not play, no matter what program

source (tuner, tape recorder, etc) is used it may be the result of a blown fuse in the output stage of the Power Amplifier. Power transistors could easily be destroyed if the speaker terminals were accidentally shorted to each other, or to the chassis. To protect the transistors, as well as the speakers, each output stage uses two fuses. These fuses are precisely rated, and manufactured to function within extremely narrow tolerances. These fuses must be replaced only with fuses rated at 1.5 amperes. Replacement with any other type of fuse, may result in damage to the unit, and voids the warranty.

If it should not work as it ought to or the speaker fuse blows at once even after the replacement, the amplifier has been damaged. In this case, replace it after repairing the amplifier.

AC PLUG RECEPTACLE

Of the two AC plug receptacles provided on the back of the amplifier, the one nearer to the output terminals can be switched on or off by means of the power switch while the other one cannot. These receptacles have capacities of 50 VA and 120 VA, respectively

OTHER NOTES

Transistors are extremely susceptible to heat. Therefore, the TR-707A must not be used in places that are exposed directly to the sun or high temperature.

SERVICE NOTE

	Symptoms (1)	Symptoms (2)	Likely defective places
When the power switch is pushed, electric supply will not be on.	A. Poor power switch. B. Poor power cord. C. Poor plug contact. D. Brown out fuse.	(In case the fuse blows again upon fitting a new one)	Replace it. Replace it. Replace the plug or make the plug contact better. Replace it. Short-circuit rearing in power transformer (T ₁₉). Path condenser (C ₁₇₀). Silicon diodes.
When the power switch is pushed, electric supply will be on.	A. It dose not work at all.	1. Blown speaker fuse. 2. In case there is something wrong in the transistor and voltage in resp. places.	Replace it. Check the places where is something wrong in voltage. Check the input circuit after AUX.
	B. Only the FM Tuner does not work at all.	1. In case there is something wrong in the transistor and voltage in resp. places in the FM system. 2. In case there is nothing wrong in resp. places in the FM system.	Check the places where is something wrong in voltage. Insufficient capacity of C ₄₉ , C ₁₉ poor I.F.T. (T ₁₂ ~T ₁₇). short circuit of C ₄₄ , C ₄₇ . Trouble in the local oscillating circuit of TR ₃ .
	C. Only the FM-MPX system does not work.	1. In case there is something wrong in the transistor and voltage in resp. places in the multiplex sistem. 2. In case there is nothing wrong in the transistor and voltage in the multiplex system.	Check the places where there is something wrong in voltage. If the FM tuner works normally, it is caused by insufficient capacity of C ₄₇ , C ₈₆ , C ₈₇ , C ₈₈ , C ₈₉ and poor L ₅ , T ₁₄ , T ₁₅ , T ₁₆ .
	D. Only the AM Tuner does not work.	1. In case there is something wrong in the transistor and voltage in resp. places in the AM Tuner system. 2. In case there is nothing wrong in the transistor and voltage in resp. places in the AM Tuner system.	Check the places where there is something wrong in voltage. Poor I.F.T. (T ₁₂ , T ₁₃) and RF coil (T ₈) poor diode (OA-79) short-circuit of C ₂₅ and C ₅₉ . Insufficient capacity of C ₇₀ .
	E. The phono, tape head mike and AUX do not work.	1. In case of poor TR head amplifier. 2. In case of the poor contact of the function switch. 3. In case there is something wrong in the input circuit. 4. Poor condition of the attached appliances to be connected. 5. Poor coupling condenser.	Replace the TR head amplifier unit. Replace it or repair the contacts. Poor contact and short circuit of the input terminal and pin jack. C ₁₁₄ , C ₁₄₈ .
	A. In case of small sounds of resp. FM, FM, Stereo AM tuners, phono, tape head, mike, Aux.	In case there is something wrong in voltage in power circuit and resp. places.	Check the places where there is something wrong in voltage.
	A. In case of small sounds of the phono, tape head, mike, and AUX with nothing wrong in voltage in resp. place.	1. Poor fixed resistor. 2. Short circuit rearing in driver transformer. 3. Drop in condenser capacity and short circuit. 4. Deterioration of transistor. 5. In case of the poor contacts of the function switch. 6. In case there is something wrong in the input circuit. 7. Poor condition of the attached appliances connected. 8. Poor coupling condensers 9. Insufficient capacity of emitter by-pass condenser.	T ₁₉ , T ₂₀ . Insufficient capacity of C ₁₁₇ , C ₁₅₁ , C ₁₂₀ , C ₁₅₃ , C ₁₂₉ , C ₁₆₁ , C ₁₃₁ , C ₁₆₃ , C ₁₃₆ , C ₁₆₈ , C ₁₁₆ , C ₁₅₂ , TR ₂₂ ~TR ₃₅ . S ₁ (a~d). Poor contact of the pin jack or poor shielding wires. C ₁₀₆ , C ₁₀₇ , C ₁₁₃ , C ₁₄₀ , C ₁₄₁ , C ₁₄₇ , C ₁₀₈ , C ₁₁₂ , C ₁₄₂ , C ₁₄₆ . C ₁₀₇ , C ₁₄₁ . C ₁₀₈ , C ₁₁₂ , C ₁₄₂ , C ₁₄₆ .

	Symptoms (1)	Symptoms (2)	Likely defective places
when the power switch is pushed, electric supply will be on.	B. In case of small FM broadcasting sounds with nothing wrong in voltage in resp. places.	<ol style="list-style-type: none"> 1. Divergence of tracking regulation. 2. Divergence in IFT regulation 3. Poor diode. 4. Drop in Q or coils etc. 5. Poor condensers. 6. Poor contact of the band switch. 	<p>Refer to the regulation method of the FM tuner.</p> <p>Refer to the regulation method of the FM tuner.</p> <p>Germanium diode (OA-79).</p> <p>T₁, T₂, L₁.</p> <p>Insufficient capacity of L₃, C₁₂, C₇, C₂₂, C₂₆, C₃₃, C₄₀, C₃₆.</p> <p>S₃ (a~b).</p>
	C. In case of small sounds of the FM multiplex stereo system with nothing wrong in voltage of resp. places.	<ol style="list-style-type: none"> 1. Insufficient capacity of the coupling condensers. 2. Divergence in regulation of coils etc. 3. Change in capacity of the condensers in the trunk circuit. 4. Deterioration of diode. 5. Poor contact of the band switch. 	<p>C₇₇, C₇₉, C₉₂, C₇₆, C₅₆, C₅₇, C₈₈, C₈₉.</p> <p>T₁₄, T₁₅, T₁₆.</p> <p>C₇₈, C₅₁, C₅₄.</p> <p>Germanium diode OA-79.</p> <p>S₃ (a~b)</p>
	D. In case of small AM broadcasting sounds with nothing wrong in voltage of resp places.	<ol style="list-style-type: none"> 1. Divergence in tracking regulation. 2. Divergence in IFT regulation. 3. Poor diode. 4. Drop in Q of coils etc. 5. Poor condensers. 6. Poor contact of the band switch 	<p>Refer to the regulation method of the AM tuner.</p> <p>Refer to the regulation method of the AM tuner.</p> <p>Germanium diode OA-79.</p> <p>L₃, T₈, T₉.</p> <p>Insufficient capacity of C₅₁, C₃₃, C₆₁, C₆₂.</p> <p>S₃ (a~b).</p>
	A. In case the sounds of the phono, tape head mike and AUX are distorted much.	<ol style="list-style-type: none"> 1. Deterioration of transistors. 2. Partial short-circuit rearing in the driver transformer. 3. Poor speaker 4. Distortion resulted from the attached appliances connected. 5. Poor electrolytic condensers. 	<p>T₁₉, T₂₀.</p> <p>C₁₀₆, C₁₄₀.</p>
	B. In case the FM broadcasting sounds are distorted much.	<ol style="list-style-type: none"> 1. Poor condition and small input of the antenna. 2. Divergence in tracking regulation 3. Divergence in regulation of IFT. 4. Poor germanium diode. 5. Insufficient capacity of the condensers in the FM tuner part. 	<p>Refer to the Item, "How to install the antenna in the catalogue."</p> <p>Refer to the regulation method of FM.</p> <p>Refer to the regulation method of FM.</p> <p>OA-79.</p> <p>C₃, C₂₀, C₂₁, C₂₃, C₂₇, C₃₃, C₄₀.</p>
	C. In case the sounds of the FM multiplex stereo system are distorted much.	<ol style="list-style-type: none"> 1. Sounds distorted at FM tuner. 2. Poor regulation of the multi coil. 3. Poor germanium diode. 4. Poor condenser. 5. poor fixed resistor. 	<p>Refer to the Item. "In case of the FM broadcasting sounds are distorted much."</p> <p>Refer to the regulation method of the FM M.P.X.</p> <p>OA-79.</p> <p>Poor insulation of C₅₆, C₅₅.</p> <p>R₃₉, R₆₁, R₆₂, R₆₄, R₅₀, R₅₆.</p>
	D. In case the AM broadcasting sounds are distorted much.	<ol style="list-style-type: none"> 1. Divergence in tracking regulation 2. Divergence in regulation of IFT 3. Poor germanium diode. 4. Insufficient capacity of condenser and short circuit. 	<p>Refer to the regulation method of AM.</p> <p>Refer to the regulation method of AM.</p> <p>OA-79.</p> <p>Insufficient capacity of C₆₀, C₆₃, C₆₆, C₆₉.</p>

SERVICE NOTE

	Symptoms (1)	Symptoms (2)	Likely defective places
When the power switch is pushed, electric supply will be on.	A. In case of big humming in the phono, tape head, mike and AUX.	<ol style="list-style-type: none"> 1. Insufficient capacity of the electrolytic condensers. 2. Big humming in the attached appliances connected. 3. Broken wires of the NF resistances. 4. Poor condition of shielding wires of sound appliances and their connection. 5. Sound appliances and the shielding wire are subjected to external induction. 6. Residual hums of sound appliances. 	<p>C₁₁₉, C₁₂₆, C₁₇₂, C₁₇₄, C₁₇₅.</p> <p>R₂₂₄, R₂₄₀.</p> <p>Refer to the Item GENERAL NOTICE in the catalogue.</p> <p>Install them as far away as, possible from the induction machines.</p>
	B. In case of big humming in FM broadcasting.	<ol style="list-style-type: none"> 1. Hums generated when tuned in a channel. 	Reverse connection of the power plug or poor earthing condition of the chassis.
	C. In case of big humming in the FM multiplex stereo system.	<ol style="list-style-type: none"> 1. Hums generated from the above mentioned causes. 	Reverse connection of the power plug or poor earthing condition of the chassis.
	D. In case of big humming in AM broadcasting.	<ol style="list-style-type: none"> 1. Hums generated when tuned in a channel. 	Reverse connection of the power plug or poor earthing condition of the chassis.
	A. In case of loud noise in the phono, tape head, mike and AUX.	<ol style="list-style-type: none"> 1. Break rearing in the fixed resistor wires and touch of parts. 2. Short circuit rearing at the condensers and touch of parts. 3. Inner noises and poor connection of the attached appliances connected. 	<p>R₁₁₅~R₁₃₂, R₁₃₄, R₁₃₅, R₁₆₇~R₁₉₁, R₁₉₃, R₁₉₄</p> <p>C₁₁₄, C₁₄₇</p>
	B. In case of a great many noises in FM broadcasting.	<ol style="list-style-type: none"> 1. Small input voltage and poor condition of the antenna. 2. Poor transistors. 3. Break rearing in the fixed resistance wires and touching of parts. 4. Short-circuit of condensers and touch of parts. 	<p>Refer to the Item Antenna in the catalogue.</p> <p>TR₁, TR₂, TR₃.</p> <p>R₁, R₂, R₃, R₆, R₁₁, R₁₆, R₂₂, R₃₁, R₃₆.</p> <p>C₃, C₁₁, C₃, C₉, C₁₂, C₂₁, C₂₅, C₃₃, C₄₀, C₄₆, C₅₀, C₄₀</p>
	C. In case of a great many noises in FM multiplex stereo system.	<ol style="list-style-type: none"> 1. Noises made by the above-mentioned causes. 2. Break rearing in the multiplex coil wire. 3. Break rearing at the fixed resistors. 4. Short-circuit rearing at condensers. 5. Poor transistors. 	<p>Refer to symptoms (1)</p> <p>L₅, T₁₄, T₁₅, T₁₆.</p> <p>R₅₀, R₆₀, R₆₄, R₆₅, R₉₂, R₉₅, R₂₄₇, R₂₄₅.</p> <p>C₈₁, C₈₂, C₈₅, C₉₂, C₉₃.</p> <p>TR₁₂~TR₁₆.</p>
	A. While the FM tuner is working normally.	<ol style="list-style-type: none"> 1. The tuning meter does not work at all. 2. The tuning meter works slightly. 	<p>Poor (M)</p> <p>It varies according to the intensity of the electric field resulted from regional differences. It is caused by poor condition of the FM antenna.</p>
	B. While the AM tuner is working normally.	<ol style="list-style-type: none"> 1. The tuning meter does not work at all. 2. The tuning meter works slightly. 	<p>Poor (M)</p> <p>It varies according to the intensity of the electric field resulted from regional differences.</p>
C. The stereo indicator is not lighted at the time of FM stereo reception.	<ol style="list-style-type: none"> 1. In case the multiplex adaptor does not work normally. 2. In case only the indicator does not work with the multiplex adaptor working normally. 3. The indicator is kept lighting while the multiplex adaptor is working normally. 	<p>Refer to the Item symptoms of respective multiplex.</p> <p>Poor PL-1, broken wire of R₉₅, R₅₆₈ and poor TR₁₇~TR₁₉.</p> <p>Poor OA-79 and poor regulation of VR-3.</p>	
D. Poor separation at the time of FM stereo reception.	<ol style="list-style-type: none"> 1. In case the multiplex adaptor works normally. 	Poor regulation of VR-2 (Refer to the regulation method of FM M.P.X)	

PARTS LIST

Part No.	Nomenclature					
R1	100 Ω	¼ Watt	10%	Carbon	Fixed	Resistor
R2	1 KΩ	¼ Watt	10%	Carbon	Fixed	Resistor
R3	2 KΩ	¼ Watt	10%	Carbon	Fixed	Resistor
R4	15 KΩ	¼ Watt	10%	Carbon	Fixed	Resistor
R5	820 KΩ	¼ Watt	10%	Carbon	Fixed	Resistor
R6	700 Ω	¼ Watt	10%	Carbon	Fixed	Resistor
R7	3 KΩ	¼ Watt	10%	Carbon	Fixed	Resistor
R8	15 KΩ	¼ Watt	10%	Carbon	Fixed	Resistor
R9	100 Ω	¼ Watt	10%	Carbon	Fixed	Resistor
R10	100 KΩ	¼ Watt	10%	Carbon	Fixed	Resistor
R11	25 KΩ	¼ Watt	10%	Carbon	Fixed	Resistor
R12	3 KΩ	¼ Watt	10%	Carbon	Fixed	Resistor
R13	100 Ω	¼ Watt	10%	Carbon	Fixed	Resistor
R14	1 KΩ	¼ Watt	10%	Carbon	Fixed	Resistor
R16	2 KΩ	¼ Watt	10%	Carbon	Fixed	Resistor
R17	20 KΩ	¼ Watt	10%	Carbon	Fixed	Resistor
R18	3 KΩ	¼ Watt	10%	Carbon	Fixed	Resistor
R19	100 Ω	¼ Watt	10%	Carbon	Fixed	Resistor
R20	1 KΩ	¼ Watt	10%	Carbon	Fixed	Resistor
R21	560 Ω	¼ Watt	10%	Carbon	Fixed	Resistor
R22	20 KΩ	¼ Watt	10%	Carbon	Fixed	Resistor
R23	4.7 KΩ	¼ Watt	10%	Carbon	Fixed	Resistor
R24	100 Ω	¼ Watt	10%	Carbon	Fixed	Resistor
R25	1 KΩ	¼ Watt	10%	Carbon	Fixed	Resistor
R26	1 KΩ	¼ Watt	10%	Carbon	Fixed	Resistor
R27	100 Ω	¼ Watt	10%	Carbon	Fixed	Resistor
R28	1 KΩ	¼ Watt	10%	Carbon	Fixed	Resistor
R29	1.5 KΩ	¼ Watt	10%	Carbon	Fixed	Resistor
R30	50 Ω	¼ Watt	10%	Carbon	Fixed	Resistor
R31	100 Ω	¼ Watt	10%	Carbon	Fixed	Resistor
R32	1 KΩ	¼ Watt	10%	Carbon	Fixed	Resistor
R33	1 KΩ	¼ Watt	10%	Carbon	Fixed	Resistor
R34	4 KΩ	¼ Watt	10%	Carbon	Fixed	Resistor
R35	4 KΩ	¼ Watt	10%	Carbon	Fixed	Resistor
R36	82 KΩ	¼ Watt	5%	Carbon	Fixed	Resistor
R37	39 KΩ	¼ Watt	10%	Carbon	Fixed	Resistor
R38	2.2 MΩ	¼ Watt	10%	Carbon	Fixed	Resistor
R39	40 KΩ	¼ Watt	10%	Carbon	Fixed	Resistor
R40	1 KΩ	¼ Watt	10%	Carbon	Fixed	Resistor
R41	5 KΩ	¼ Watt	10%	Carbon	Fixed	Resistor
R42	2 KΩ	¼ Watt	10%	Carbon	Fixed	Resistor
R43	100 KΩ	¼ Watt	10%	Carbon	Fixed	Resistor
R44	120 Ω	¼ Watt	10%	Carbon	Fixed	Resistor
R45	1 KΩ	¼ Watt	10%	Carbon	Fixed	Resistor
R46	200 Ω	¼ Watt	10%	Carbon	Fixed	Resistor
R47	60 KΩ	¼ Watt	10%	Carbon	Fixed	Resistor
R48	1 KΩ	¼ Watt	10%	Carbon	Fixed	Resistor
R49	100 KΩ	¼ Watt	10%	Carbon	Fixed	Resistor
R50	2 KΩ	¼ Watt	10%	Carbon	Fixed	Resistor
R51	300 Ω	¼ Watt	10%	Carbon	Fixed	Resistor
R52	5 KΩ	¼ Watt	10%	Carbon	Fixed	Resistor
R53	100 Ω	¼ Watt	10%	Carbon	Fixed	Resistor
R54	850 Ω	¼ Watt	10%	Carbon	Fixed	Resistor
R55	1 KΩ	¼ Watt	10%	Carbon	Fixed	Resistor
R56	5 KΩ	¼ Watt	10%	Carbon	Fixed	Resistor
R57	15 KΩ	¼ Watt	10%	Carbon	Fixed	Resistor
R58	2.2 KΩ	¼ Watt	10%	Carbon	Fixed	Resistor
R59	47 KΩ	¼ Watt	10%	Carbon	Fixed	Resistor
R60	10 KΩ	¼ Watt	10%	Carbon	Fixed	Resistor
R61	15 KΩ	¼ Watt	10%	Carbon	Fixed	Resistor
R62	470 Ω	¼ Watt	10%	Carbon	Fixed	Resistor

Part No.	Nomenclature					
R63	1 KΩ	¼ Watt	10%	Carbon	Fixed	Resistor
R64	5.1 KΩ	¼ Watt	10%	Carbon	Fixed	Resistor
R65	3.3 KΩ	¼ Watt	10%	Carbon	Fixed	Resistor
R66	51 KΩ	¼ Watt	10%	Carbon	Fixed	Resistor
R67	5.1 KΩ	¼ Watt	10%	Carbon	Fixed	Resistor
R68	51 Ω	¼ Watt	10%	Carbon	Fixed	Resistor
R69	680 Ω	¼ Watt	10%	Carbon	Fixed	Resistor
R70	6.8 KΩ	¼ Watt	10%	Carbon	Fixed	Resistor
R71	51 KΩ	¼ Watt	10%	Carbon	Fixed	Resistor
R72	5.1 KΩ	¼ Watt	10%	Carbon	Fixed	Resistor
R73	22 Ω	¼ Watt	10%	Carbon	Fixed	Resistor
R74	680 Ω	¼ Watt	10%	Carbon	Fixed	Resistor
R75	10 KΩ	¼ Watt	10%	Carbon	Fixed	Resistor
R76	10 KΩ	¼ Watt	10%	Carbon	Fixed	Resistor
R77	10 KΩ	¼ Watt	10%	Carbon	Fixed	Resistor
R78	10 KΩ	¼ Watt	10%	Carbon	Fixed	Resistor
R79	10 KΩ	¼ Watt	10%	Carbon	Fixed	Resistor
R80	39 KΩ	¼ Watt	10%	Carbon	Fixed	Resistor
R81	1 KΩ	¼ Watt	10%	Carbon	Fixed	Resistor
R82	2.7 KΩ	¼ Watt	10%	Carbon	Fixed	Resistor
R83	1 KΩ	¼ Watt	10%	Carbon	Fixed	Resistor
R84	2.7 KΩ	¼ Watt	10%	Carbon	Fixed	Resistor
R85	10 KΩ	¼ Watt	10%	Carbon	Fixed	Resistor
R86	39 KΩ	¼ Watt	10%	Carbon	Fixed	Resistor
R87	22 KΩ	¼ Watt	10%	Carbon	Fixed	Resistor
R88	22 KΩ	¼ Watt	10%	Carbon	Fixed	Resistor
R89	220 KΩ	¼ Watt	10%	Carbon	Fixed	Resistor
R90	220 KΩ	¼ Watt	10%	Carbon	Fixed	Resistor
R91	51 KΩ	¼ Watt	10%	Carbon	Fixed	Resistor
R92	10 KΩ	¼ Watt	10%	Carbon	Fixed	Resistor
R93	8.2 KΩ	¼ Watt	10%	Carbon	Fixed	Resistor
R94	51 KΩ	¼ Watt	10%	Carbon	Fixed	Resistor
R95	10 KΩ	¼ Watt	10%	Carbon	Fixed	Resistor
R96	8.2 KΩ	¼ Watt	10%	Carbon	Fixed	Resistor
R97	560 Ω	¼ Watt	10%	Carbon	Fixed	Resistor
R98	15 KΩ	¼ Watt	10%	Carbon	Fixed	Resistor
R99	15 KΩ	¼ Watt	10%	Carbon	Fixed	Resistor
R100	51 KΩ	¼ Watt	10%	Carbon	Fixed	Resistor
R101	51 Ω	¼ Watt	10%	Carbon	Fixed	Resistor
R102	1.8 KΩ	¼ Watt	10%	Carbon	Fixed	Resistor
R103	5.1 KΩ	¼ Watt	10%	Carbon	Fixed	Resistor
R104	330 Ω	¼ Watt	10%	Carbon	Fixed	Resistor
R105	10 KΩ	¼ Watt	10%	Carbon	Fixed	Resistor
R106	3.3 KΩ	¼ Watt	10%	Carbon	Fixed	Resistor
R107	1 KΩ	¼ Watt	10%	Carbon	Fixed	Resistor
R108	2.2 KΩ	¼ Watt	10%	Carbon	Fixed	Resistor
R109	8.2 KΩ	¼ Watt	10%	Carbon	Fixed	Resistor
R110	22 KΩ	¼ Watt	10%	Carbon	Fixed	Resistor
R111	1 KΩ	¼ Watt	10%	Carbon	Fixed	Resistor
R112	1 KΩ	¼ Watt	10%	Carbon	Fixed	Resistor
R113	8.2 KΩ	¼ Watt	10%	Carbon	Fixed	Resistor
R114	3.3 KΩ	¼ Watt	10%	Carbon	Fixed	Resistor
R115	8.2 KΩ	¼ Watt	10%	Carbon	Fixed	Resistor
R116	5.1 KΩ	¼ Watt	10%	Carbon	Fixed	Resistor
R117	100 KΩ	¼ Watt	10%	Carbon	Fixed	Resistor
R118	150 KΩ	¼ Watt	10%	Noise	Less	Resistor
R119	1 KΩ	¼ Watt	10%	Carbon	Fixed	Resistor
R120	100 KΩ	¼ Watt	10%	Noise	Less	Resistor
R121	170 KΩ	¼ Watt	10%	Noise	Less	Resistor
R122	15 KΩ	¼ Watt	10%	Noise	Less	Resistor
R123	300 Ω	¼ Watt	10%	Carbon	Fixed	Resistor

PARTS LIST

Part No.	Nomenclature					
R124	15 K Ω	1/4 Watt	10%	Noise	Less	Resistor
R125	16 K Ω	1/4 Watt	10%	Carbon	Fixed	Resistor
R126	5 K Ω	1/4 Watt	10%	Carbon	Fixed	Resistor
R127	33 K Ω	1/4 Watt	10%	Carbon	Fixed	Resistor
R128	15 K Ω	1/4 Watt	10%	Noise	Less	Resistor
R129	70 K Ω	1/4 Watt	10%	Noise	Less	Resistor
R130	3 K Ω	1/4 Watt	10%	Noise	Less	Resistor
R131	10 Ω	1/4 Watt	10%	Carbon	Fixed	Resistor
R132	12 K Ω	1/4 Watt	10%	Noise	Less	Resistor
R133	33 K Ω	1/4 Watt	10%	Carbon	Fixed	Resistor
R134	180 K Ω	1/4 Watt	10%	Carbon	Fixed	Resistor
R135	180 K Ω	1/4 Watt	10%	Carbon	Fixed	Resistor
R136	10 K Ω	1/4 Watt	10%	Carbon	Fixed	Resistor
R137	2.2 K Ω	1/4 Watt	10%	Carbon	Fixed	Resistor
R138	33 K Ω	1/4 Watt	10%	Carbon	Fixed	Resistor
R139	82 K Ω	1/4 Watt	10%	Carbon	Fixed	Resistor
R140	270 K Ω	1/4 Watt	10%	Carbon	Fixed	Resistor
R141	1 K Ω	1/4 Watt	10%	Carbon	Fixed	Resistor
R142	3.3 K Ω	1/4 Watt	10%	Carbon	Fixed	Resistor
R143	10 K Ω	1/4 Watt	10%	Carbon	Fixed	Resistor
R144	18 K Ω	1/4 Watt	10%	Carbon	Fixed	Resistor
R145	3.9 K Ω	1/4 Watt	10%	Carbon	Fixed	Resistor
R146	18 K Ω	1/4 Watt	10%	Carbon	Fixed	Resistor
R147	2.7 K Ω	1/4 Watt	10%	Carbon	Fixed	Resistor
R148	56 K Ω	1/4 Watt	10%	Carbon	Fixed	Resistor
R149	150 K Ω	1/4 Watt	10%	Carbon	Fixed	Resistor
R150	1 K Ω	1/4 Watt	10%	Carbon	Fixed	Resistor
R151	5 K Ω	1/4 Watt	10%	Carbon	Fixed	Resistor
R152	10 K Ω	1/4 Watt	10%	Carbon	Fixed	Resistor
R153	56 K Ω	1/4 Watt	10%	Carbon	Fixed	Resistor
R154	39 K Ω	1/4 Watt	10%	Carbon	Fixed	Resistor
R155	100 K Ω	1/4 Watt	10%	Carbon	Fixed	Resistor
R156	3.9 K Ω	1/4 Watt	10%	Carbon	Fixed	Resistor
R157	5.1 K Ω	1/4 Watt	10%	Carbon	Fixed	Resistor
R158	330 K Ω	1/4 Watt	10%	Carbon	Fixed	Resistor
R159	100 K Ω	1/4 Watt	10%	Carbon	Fixed	Resistor
R160	2.7 K Ω	1/4 Watt	10%	Carbon	Fixed	Resistor
R161	510 K Ω	1/4 Watt	10%	Carbon	Fixed	Resistor
R162	150 K Ω	1/4 Watt	10%	Carbon	Fixed	Resistor
R163	150 K Ω	1/4 Watt	10%	Carbon	Fixed	Resistor
R164	510 K Ω	1/4 Watt	10%	Carbon	Fixed	Resistor
R165	5.1 K Ω	1/4 Watt	10%	Carbon	Fixed	Resistor
R166	100 K Ω	1/4 Watt	10%	Carbon	Fixed	Resistor
R167	150 K Ω	1/4 Watt	10%	Noise	Less	Resistor
R168	1 K Ω	1/4 Watt	10%	Carbon	Fixed	Resistor
R169	100 K Ω	1/4 Watt	10%	Noise	Less	Resistor
R170	170 K Ω	1/4 Watt	10%	Noise	Less	Resistor
R171	15 K Ω	1/4 Watt	10%	Noise	Less	Resistor
R172	300 Ω	1/4 Watt	10%	Carbon	Fixed	Resistor
R173	15 K Ω	1/4 Watt	10%	Noise	Less	Resistor
R174	15 K Ω	1/4 Watt	10%	Noise	Less	Resistor
R175	70 K Ω	1/4 Watt	10%	Noise	Less	Resistor
R176	16 K Ω	1/4 Watt	10%	Carbon	Fixed	Resistor
R177	5 K Ω	1/4 Watt	10%	Carbon	Fixed	Resistor
R178	12 K Ω	1/4 Watt	10%	Carbon	Fixed	Resistor
R179	3 K Ω	1/4 Watt	10%	Noise	Less	Resistor
R180	10 Ω	1/4 Watt	10%	Carbon	Fixed	Resistor
R181	12 K Ω	1/4 Watt	10%	Noise	Less	Resistor
R182	33 K Ω	1/4 Watt	10%	Carbon	Fixed	Resistor
R183	180 K Ω	1/4 Watt	10%	Carbon	Fixed	Resistor
R184	180 K Ω	1/4 Watt	10%	Carbon	Fixed	Resistor

Part No.	Nomenclature					
R185	10 K Ω	1/4 Watt	10%	Carbon	Fixed	Resistor
R186	2.2 K Ω	1/4 Watt	10%	Carbon	Fixed	Resistor
R187	82 K Ω	1/4 Watt	10%	Carbon	Fixed	Resistor
R188	270 K Ω	1/4 Watt	10%	Carbon	Fixed	Resistor
R189	1 K Ω	1/4 Watt	10%	Carbon	Fixed	Resistor
R190	3.3 K Ω	1/4 Watt	10%	Carbon	Fixed	Resistor
R191	10 K Ω	1/4 Watt	10%	Carbon	Fixed	Resistor
R192	18 K Ω	1/4 Watt	10%	Carbon	Fixed	Resistor
R193	3.9 K Ω	1/4 Watt	10%	Carbon	Fixed	Resistor
R194	18 K Ω	1/4 Watt	10%	Carbon	Fixed	Resistor
R195	56 K Ω	1/4 Watt	10%	Carbon	Fixed	Resistor
R196	150 K Ω	1/4 Watt	10%	Carbon	Fixed	Resistor
R197	1 K Ω	1/4 Watt	10%	Carbon	Fixed	Resistor
R198	5.1 K Ω	1/4 Watt	10%	Carbon	Fixed	Resistor
R199	10 K Ω	1/4 Watt	10%	Carbon	Fixed	Resistor
R200	50 K Ω	1/4 Watt	10%	Carbon	Fixed	Resistor
R201	39 K Ω	1/4 Watt	10%	Carbon	Fixed	Resistor
R202	100 K Ω	1/4 Watt	10%	Carbon	Fixed	Resistor
R203	3.9 K Ω	1/4 Watt	10%	Carbon	Fixed	Resistor
R204	5.1 K Ω	1/4 Watt	10%	Carbon	Fixed	Resistor
R205	330 K Ω	1/4 Watt	10%	Carbon	Fixed	Resistor
R206	100 K Ω	1/4 Watt	10%	Carbon	Fixed	Resistor
R207	2.7 K Ω	1/4 Watt	10%	Carbon	Fixed	Resistor
R208	560 Ω	3 Watt	10%	Carbon	Fixed	Resistor
R209	1 K Ω	2 Watt	10%	Carbon	Fixed	Resistor
R210	2.2 K Ω	1/2 Watt	10%	Carbon	Fixed	Resistor
R211	2.2 K Ω	1/2 Watt	10%	Carbon	Fixed	Resistor
R212	2.7 K Ω	1/2 Watt	10%	Carbon	Fixed	Resistor
R213	1.2 K Ω	1 Watt	10%	Carbon	Fixed	Resistor
R214	3.9 K Ω	1/4 Watt	10%	Carbon	Fixed	Resistor
R215	180 Ω	1/2 Watt	10%		Solid	Resistor
R216	1.5 K Ω	1/4 Watt	10%	Carbon	Fixed	Resistor
R217	820 Ω	1/4 Watt	10%	Carbon	Fixed	Resistor
R218	510 Ω	1/2 Watt	10%	Carbon	Fixed	Resistor
R219	3.9 K Ω	1/4 Watt	10%	Carbon	Fixed	Resistor
R220	12 K Ω	1/4 Watt	10%	Carbon	Fixed	Resistor
R221	15 Ω	1/4 Watt	10%	Carbon	Fixed	Resistor
R222	180 Ω	1/2 Watt	10%	Carbon	Fixed	Resistor
R223	270 Ω	3 Watt	10%	Carbon	Fixed	Resistor
R224	100 Ω	2 Watt	10%	Carbon	Fixed	Resistor
R225	250 Ω	10Watt	10%	Wire	Wound	Resistor
R226	250 Ω	10Watt	10%	Wire	Wound	Resistor
R227	5.1 Ω	1/2 Watt	10%	Carbon	Fixed	Resistor
R228	5.1 Ω	1/2 Watt	10%	Carbon	Fixed	Resistor
R229	1 Ω	2 Watt	10%	Wire	Wound	Resistor
R230	1 Ω	2 Watt	10%	Wire	Wound	Resistor
R232	470 Ω	1 Watt	10%	Carbon	Fixed	Resistor
R233	5.6 K Ω	1/4 Watt	10%	Carbon	Fixed	Resistor
R234	5.6 K Ω	1/4 Watt	10%	Carbon	Fixed	Resistor
R235	5.1 K Ω	1/4 Watt	10%	Carbon	Fixed	Resistor
R236	3.9 K Ω	1/4 Watt	10%	Carbon	Fixed	Resistor
R237	12 K Ω	1/4 Watt	10%	Carbon	Fixed	Resistor
R238	15 Ω	1/4 Watt	10%	Carbon	Fixed	Resistor
R239	180 Ω	1/2 Watt	10%	Carbon	Fixed	Resistor
R240	100 Ω	2 Watt	10%	Carbon	Fixed	Resistor
R241	250 Ω	10Watt	10%	Wire	Wound	Resistor
R242	250 Ω	10Watt	10%	Wire	Wound	Resistor
R243	5.1 Ω	1/2 Watt	10%	Carbon	Fixed	Resistor
R244	5.1 Ω	1/2 Watt	10%	Carbon	Fixed	Resistor
R245	1 Ω	2 Watt	10%	Wire	Wound	Resistor
R246	1 Ω	2 Watt	10%	Wire	Wound	Resistor

Part No.	Nomenclature					
R248	470 Ω	1 Watt	10%	Carbon	Fixed	Resistor
R249	51 KΩ	¼ Watt	10%	Carbon	Fixed	Resistor
R250	33 KΩ	¼ Watt	10%	Carbon	Fixed	Resistor
R251	6.8 KΩ	¼ Watt	10%	Carbon	Fixed	Resistor
R252	6.8 KΩ	¼ Watt	10%	Carbon	Fixed	Resistor
R253	100 KΩ	¼ Watt	10%	Carbon	Fixed	Resistor
R254	1 MΩ	½ Watt	10%		Solid	Resistor
C1	6 pF	50 WV	±0.5 pF	Ceramic	tubular	
C2	25 pF	50 WV	±10%	Ceramic	tubular	
C3	0.002 μF	25 WV	+100% -0%	Ceramic	tubular	
C4	20 pF	50 WV	±10%	Ceramic	tubular	
C5	0.02 μF	25 WV	+100% -0%	Ceramic	tubular	
C6	30 pF	50 WV	±10%	Ceramic	tubular	
C7	0.002 μF	25 WV	+100% -0%	Ceramic	tubular	
C8	3 pF	50 WV	±0.5 pF	Ceramic	tubular	
C9	7 pF	50 WV	±0.5 pF	Ceramic	tubular	
C10	5 pF	50 WV	±0.5 pF	Ceramic	tubular	
C11	0.002 μF	25 WV	+100% -0%	Ceramic	tubular	
C12	0.002 μF	25 WV	+100% -0%	Ceramic	tubular	
C13	0.02 μF	25 WV	+100% -0%	Ceramic	tubular	
C14	10 pF	50 WV	±0.5 pF	Ceramic	tubular	
C15	30 μF	10 WV		electrolytic	tubular	
C16	50 pF	50 WV	±10%	Ceramic	tubular	
C17	1 pF	50 WV	±0.5 pF	Ceramic	tubular	
C18	80 pF	50 WV	±10%	Ceramic	tubular	
C19	0.01 μF	25 WV	+100% -0%	Ceramic	tubular	
C20	8 pF	50 WV	±0.5 pF	Ceramic	tubular	
C21	0.02 μF	25 WV	+100% -0%	Ceramic	tubular	
C22	0.02 μF	25 WV	+100% -0%	Ceramic	tubular	
C23	0.02 μF	25 WV	+100% -0%	Ceramic	tubular	
C24	50 pF	50 WV	±5%	Ceramic	tubular	
C25	0.02 μF	25 WV	+100% -0%	Ceramic	tubular	
C26	0.02 μF	25 WV	+100% -0%	Ceramic	tubular	
C27	6 pF	50 WV	±0.5 pF	Ceramic	tubular	
C28	0.05 μF	25 WV	+100% -0%	Ceramic	tubular	
C29	0.02 μF	25 WV	+100% -0%	Ceramic	tubular	
C30	50 pF	50 WV	±5%	Ceramic	tubular	
C31	0.02 μF	25 WV	+100% -0%	Ceramic	tubular	
C32	0.02 μF	25 WV	+100% -0%	Ceramic	tubular	
C33	7 pF	50 WV	±0.5 pF	Ceramic	tubular	
C34	8 pF	50 WV	±0.5 pF	Ceramic	tubular	
C35	2 pF	50 WV	±0.2 pF	Ceramic	tubular	
C36	0.02 μF	25 WV	+100% -0%	Ceramic	tubular	
C37	50 pF	50 WV	±5%	Ceramic	tubular	
C38	0.02 μF	25 WV	+100% -0%	Ceramic	tubular	
C39	0.02 μF	25 WV	+100% -0%	Ceramic	tubular	
C40	4 pF	50 WV	±0.5 pF	Ceramic	tubular	
C41	0.05 μF	25 WV	+100% -0%	Ceramic	tubular	
C42	200 μF	10 WV		electrolytic	tubular	
C43	200 μF	10 WV		electrolytic	tubular	
C44	50 pF	50 WV	±5%	Ceramic	tubular	
C45	200 pF	50 WV	±10%	Ceramic	tubular	
C46	200 pF	50 WV	±10%	Ceramic	tubular	
C47	0.005 μF	400 WV	±5%	Oil	tubular	

Part No.	Nomenclature					
C48	5 μF	10 WV		electrolytic	tubular	
C49	10 μF	12 WV		electrolytic	tubular	
C50	100 pF	50 WV	±10%	Ceramic	tubular	
C51	0.02 μF	25 WV	+100% -0%	Ceramic	tubular	
C52	0.02 μF	25 WV	+100% -0%	Ceramic	tubular	
C53	0.02 μF	25 WV	+100% -0%	Ceramic	tubular	
C54	0.05 μF	25 WV	+100% -0%	Ceramic	tubular	
C55	0.005 μF	25 WV	+100% -0%	Ceramic	tubular	
C56	200 μF	10 WV		electrolytic	tubular	
C57	15 pF	50 WV	±10%	Ceramic	tubular	
C58	330 pF	50 WV	±5%	Styrol	condenser	
C59	10 μF	12 WV		electrolytic	tubular	
C60	2 pF	50 WV	±0.5 pF	Ceramic	tubular	
C61	0.02 μF	25 WV	+100% -0%	Ceramic	tubular	
C62	0.02 μF	25 WV	+100% -0%	Ceramic	tubular	
C63	1 pF	50 WV	±0.5 pF	Ceramic	tubular	
C64	0.05 μF	25 WV	+100% -0%	Ceramic	tubular	
C65	0.05 μF	25 WV	+100% -0%	Ceramic	tubular	
C66	200 μF	10 WV		electrolytic	tubular	
C67	200 μF	10 WV		electrolytic	tubular	
C68	0.01 μF	50 WV	±10%	mylar	tubular	
C69	0.01 μF	50 WV	±10%	mylar	tubular	
C70	0.47 μF	25 WV	±20%	Aluminum solid	electrolytic condenser	
C71	0.02 μF	25 WV	+100% -0%	Ceramic	tubular	
C72	0.1 μF	50 WV	±10%	mylar	tubular	
C73	700 pF	50 WV	±5%	Mica	tubular	
C74	10 μF	12 WV		electrolytic	tubular	
C75	10 μF	12 WV		electrolytic	tubular	
C76	200 μF	6 WV		electrolytic	tubular	
C77	30 μF	10 WV		electrolytic	tubular	
C78	8000 pF	50 WV	±5%	Mica	tubular	
C79	0.05 μF	50 WV	±10%	mylar	tubular	
C80	30 μF	6 WV		electrolytic	tubular	
C81	0.012 μF	50 WV	±5%	Mica	tubular	
C82	0.05 μF	50 WV	±10%	mylar	tubular	
C83	30 μF	6 WV		electrolytic	tubular	
C84	4700 pF	50 WV	±5%	Mica	tubular	
C85	100 μF	15 WV		electrolytic	tubular	
C86	10 μF	12 WV		electrolytic	tubular	
C87	10 μF	12 WV		electrolytic	tubular	
C88	10 μF	12 WV		electrolytic	tubular	
C89	10 μF	12 WV		electrolytic	tubular	
C90	0.0015 μF	400 WV	±10%	Oil	tubular	
C91	0.0015 μF	400 WV	±10%	Oil	tubular	
C92	82 pF	50 WV	±5%	Mica	tubular	
C93	430 pF	50 WV	±5%	Mica	tubular	
C94	510 pF	50 WV	±5%	Mica	tubular	
C95	82 pF	50 WV	±5%	Mica	tubular	
C96	430 pF	50 WV	±5%	Mica	tubular	
C97	510 pF	50 WV	±5%	Mica	tubular	
C98	0.02 μF	25 WV	+100% -0%	Ceramic	tubular	
C99	0.02 μF	25 WV	+100% -0%	Ceramic	tubular	
C100	0.02 μF	25 WV	+100% -0%	Ceramic	tubular	
C101	0.02 μF	25 WV	+100% -0%	Ceramic	tubular	

PARTS LIST

Part No.	Nomenclature			
C102	0.01 μ F	50 WV	$\pm 10\%$	mylar tubular
C103	30 μ F	6 WV		electrolytic tubular
C104	0.05 μ F	50 WV	$\pm 10\%$	mylar tubular
C105	0.05 μ F	50 WV	$\pm 10\%$	mylar tubular
C106	30 μ F	10 WV		electrolytic tubular
C107	30 μ F	12 WV		electrolytic tubular
C108	30 μ F	10 WV		electrolytic tubular
C109	0.01 μ F	50 WV	$\pm 10\%$	mylar tubular
C110	0.025 μ F	50 WV	$\pm 10\%$	mylar tubular
C111	0.006 μ F	50 WV	$\pm 10\%$	mylar tubular
C112	30 μ F	10 WV		electrolytic tubular
C113	10 μ F	12 WV		electrolytic tubular
C114	3 μ F	25 WV		electrolytic tubular
C115	300 pF	500 WV	$\pm 10\%$	Mica tubular
C116	0.01 μ F	50 WV	$\pm 10\%$	mylar tubular
C117	0.5 μ F	50 WV	$\pm 20\%$	mylar tubular
C118	30 μ F	6 WV		electrolytic tubular
C119	200 μ F	6 WV		electrolytic tubular
C120	10 μ F	12 WV		electrolytic tubular
C121	30 μ F	6 WV		electrolytic tubular
C122	0.2 μ F	50 WV	$\pm 10\%$	mylar tubular
C123	0.01 μ F	50 WV	$\pm 10\%$	mylar tubular
C124	350 pF	500 WV	$\pm 10\%$	Mica tubular
C125	0.001 μ F	400 WV	$\pm 10\%$	Oil tubular
C126	200 μ F	25 WV		electrolytic tubular
C127	0.1 μ F	50 WV	$\pm 10\%$	mylar tubular
C128	0.01 μ F	50 WV	$\pm 10\%$	mylar tubular
C129	3 μ F	25 WV		electrolytic tubular
C130	30 μ F	6 WV		electrolytic tubular
C131	30 μ F	10 WV		electrolytic tubular
C132	0.0015 μ F	400 WV	$\pm 10\%$	Oil tubular
C133	30 μ F	6 WV		electrolytic tubular
C134	10 μ F	12 WV		electrolytic tubular
C135	30 μ F	15 WV		electrolytic tubular
C136	30 μ F	25 WV		electrolytic tubular
C137	0.47 μ F	25 WV	$\pm 20\%$	Aluminum solid electrolytic condenser
C140	30 μ F	10 WV		electrolytic tubular
C141	30 μ F	12 WV		electrolytic tubular
C142	30 μ F	10 WV		electrolytic tubular
C143	0.01 μ F	50 WV	$\pm 10\%$	mylar tubular
C144	0.025 μ F	50 WV	$\pm 10\%$	mylar tubular
C145	0.006 μ F	50 WV	$\pm 10\%$	mylar tubular
C146	30 μ F	10 WV		electrolytic tubular
C147	10 μ F	12 WV		electrolytic tubular
C148	3 μ F	25 WV		electrolytic tubular
C149	300 pF	500 WV	$\pm 10\%$	Mica tubular
C150	0.01 μ F	50 WV	$\pm 10\%$	mylar tubular
C151	0.5 μ F	50 WV	$\pm 10\%$	mylar tubular
C152	30 μ F	6 WV		electrolytic tubular
C153	10 μ F	12 WV		electrolytic tubular
C154	30 μ F	6 WV		electrolytic tubular
C155	0.2 μ F	50 WV	$\pm 20\%$	mylar tubular
C156	0.01 μ F	50 WV	$\pm 10\%$	mylar tubular
C157	350 pF	500 WV	$\pm 10\%$	Mica tubular
C158	0.001 μ F	400 WV	$\pm 10\%$	Oil tubular
C159	0.1 μ F	50 WV	$\pm 10\%$	mylar tubular
C160	0.01 μ F	50 WV	$\pm 10\%$	mylar tubular
C161	3 μ F	25 WV		electrolytic tubular
C162	30 μ F	6 WV		electrolytic tubular

Part No.	Nomenclature			
C163	30 μ F	10 WV		electrolytic tubular
C164	30 μ F	6 WV		electrolytic tubular
C165	0.0015 μ F	400 WV	$\pm 10\%$	Oil tubular
C166	30 μ F	15 WV		electrolytic tubular
C167	10 μ F	12 WV		electrolytic tubular
C168	30 μ F	25 WV		electrolytic tubular
C169	0.47 μ F	25 WV	$\pm 20\%$	Aluminum solid electrolytic condenser
C170	0.0047 μ F	600 WV	$\pm 10\%$	Oil tubular
C171	200 μ F	25 WV		electrolytic tubular
C172	1000 μ F	60 WV		electrolytic lug terminal
C173	2000 μ F	60 WV		electrolytic lug terminal
C174	500 μ F	25 WV		electrolytic tubular
C175	500 μ F	15 WV		electrolytic tubular
C176	25 μ F	25 WV		electrolytic tubular
C177	600 μ F	40 WV		electrolytic tubular
C178	1000 μ F	6 WV		electrolytic tubular
C180	2000 μ F	50 WV		electrolytic lug terminal
C181	1000 μ F	6 WV		electrolytic tubular
C183	2000 μ F	50 WV		electrolytic lug terminal
C184	30 pF	50 WV	$\pm 5\%$	Ceramic tubular
C185	200 μ F	25 WV		electrolytic tubular
C186	200 μ F	50 WV		electrolytic tubular
VR-1	20 K Ω (B)	Variable Resistor	Driver type	
VR-2	5 K Ω (B)	Variable Resistor	Driver type	
VR-3	5 K Ω (B)	Variable Resistor	Driver type	
VR-4, VR-5	250 K Ω (B)	Variable Resistor	24 ϕ type	
VR-6, VR-7	100 K Ω (A)	Variable Resistor	24 ϕ friction type (Tone Control)	
VR-8, VR-9	100 K Ω (A)	Variable Resistor	24 ϕ friction type (Tone Control)	
VR-10, VR-11	125 K Ω (B,H)	Variable Resistor	24 ϕ type (Balance Control)	
VC-1	4 ~ 20 pF	Variable Capacitor	(FM, RF tuning)	
VC-2	4 ~ 20 pF	Variable Capacitor	(FM, RF tuning)	
VC-3	4 ~ 20 pF	Variable Capacitor	(FM, oscillator)	
VC-4	10.8 ~ 326.8 pF	Variable Capacitor	(AM, RF tuning)	
VC-5	10.8 ~ 326.8 pF	Variable Capacitor	(AM, RF tuning)	
VC-6	10.8 ~ 326.8 pF	Variable Capacitor	(AM, oscillator)	
TC-1	10 pF	trimmer condenser		
TC-2	10 pF	trimmer condenser		
TC-3	10 pF	trimmer condenser		
TC-4	15 pF	trimmer condenser		
TC-5	15 pF	trimmer condenser		
TC-6	15 pF	trimmer condenser		
TR1	2SA435	FM, RF Amp		
TR2	2SA435	FM, Mixer		
TR3	2SA235	FM, oscillator		
TR4	2SA70 or 2SA341	FM, 1st IF Amp		
TR5	2SA70 or 2SA341	FM, 2nd IF Amp		
TR6	2SA70	FM, 3rd IF Amp		
TR7	2SA70	FM, 4th IF Amp		
TR8	2SA102	AM, RF Amp		
TR9	2SA102	AM, oscillator and Mixer		
TR10	2SA101	AM, 1st IF Amp		
TR11	2SA101	AM, 2nd IF Amp		
TR12	2SA49	M.P.X. Amp		
TR13	2SB54	19 Kc/s Amp		
TR14	2SA49	19 Kc/s synchro and doubler		
TR15	2SB54	Dual, out deemphasis		

Part No.	Nomenclature	
TR16	2SB54	Dual, out deemphasis
TR17	2SA49	19 Kc/s Amp
TR18	2SB54	D.C. Amp
TR19	2SB202 or 2SB200	Indicator Amp
TR20	2SC402 or 2SC372	Muting Amp
TR22	2SB381	Pre Amp
TR23	2SB381	Pre Amp
TR24	2SB378A or 2SB220 or 2SB400	Pre Amp
TR25	2SB378A or 2SB220	Pre Amp
TR26	2SB381	Pre Amp
TR27	2SB378A or 2SB220	Pre Amp
TR28	2SB381	Pre Amp
TR29	2SB381	Pre Amp
TR30	2SB381	Pre Amp
TR31	2SB378A or 2SB220 or 2SB400	Pre Amp
TR32	2SB378A or 2SB220	Pre Amp
TR33	2SB381	Pre Amp
TR34	2SB378A or 2SB220	Pre Amp
TR35	2SB381	Pre Amp
TR36	2SC292	Driver Amp
TR37	2SC245	Power Amp
TR38	2SC245	Power Amp
TR39	2SC292	Driver Amp
TR40	2SC245	Power Amp
TR41	2SC245	Power Amp
L1	FM. oscillator coil	
L2	FM. coil 3.5 μ H	
L3	AM. Loop stick Antenna coil (LW, MW)	
L4	AM. coil 10 mH	
L5	M.P.X. coil MFC-6AT	
L6	Filter choke	
T1	FM. Antenna coil	
T2	FM. RF coil	
T3	FM. 1st I.F.T. 10.7 Mc/s	
T4	FM. 2nd I.F.T. 10.7 Mc/s	
T5	FM. 3rd I.F.T. 10.7 Mc/s	
T6	FM. 4th I.F.T. 10.7 Mc/s	
T7	FM. Discriminator transformer	
T8	AM. RF coil	
T9	AM. oscillator coil	
T10	AM. oscillator coil	
T11	AM. 1st I.F.T. 455 Kc/s	
T12	AM. 2nd I.F.T. 455 Kc/s	
T13	AM. 3rd I.F.T. 455 Kc/s	
T14	M.P.X. coil M.P.T.-6AT	
T15	M.P.X. coil M.P.T.-6BT	
T16	M.P.X. coil M.P.T.-6CT	
T17	FM. Muting coil	
T18	Power transformer	
T19	Driver transformer (Primary 560 Ω Secondary 30 Ω \times 2)	
T20	Driver transformer (Primary 560 Ω Secondary 30 Ω \times 2)	
IS352	Variable capacitor (FM. AFC)	
SE-1.5a	Si, diode AC (PIV) 400V I _D 1.5A -55°C~100°C	
SW-0.5a	Si, diode (PIV) 300V I _D 0.5A -55°C~100°C	

Part No.	Nomenclature	
OA-79	Ge, diode V _D = 30V I _D = 35 mA -50°C~60°C	
JAC-1	Head phone Jack	
JAC-2	D.I.N. Jack (tape recorder connection)	
PU-1	Power Adjustment for 100V/117V/240V	
PL-1	M.P.X. Indicator Lamp 12V 60 mA	
PL-2	Pilot Lamp Fuse type 6.3V 0.3A	
PL-3	Pilot Lamp Fuse type 6.3V 0.3A	
PL-4	Pilot Lamp 8V 0.15A	
F1	Speaker Fuse 1.5A	
F2	Speaker Fuse 1.5A	
F3	Power Fuse 2A	
M	Tuning meter 100 μ A	
PS-1	Power Switch	
CO-1	AC. Receptacles	
CO-2	AC. Receptacles	
S1(a~f)	Function switch Y-3-6-5	
S2(a~d)	Mode Switch Y-2-4-5	
S3(a~n)	Band Switch Y-2-6-3	
S4a	FM. AFC Switch	
S5(a~b)	Cartridge switch	
S6(a~b)	Loudness switch	
S7(a~b)	Tape Monitor switch	
S8(a~b)	High Filter switch	
S9(a~b)	Low Filter switch	
S10(a~b)	Speaker switch	
S11a	Muting switch	

ALIGNMENT

FM ALIGNMENT PROCEDURE

1. AFC-OFF

2. Turn tuning gang fully Center carrier wave.

Set pointer at reference mark.

STEP	ALIGN	GENERATOR	FEED SIGNAL	OUTPUT INDICATOR	DIAL SETTING	ADJUST-	ADJUST FOR
1.	IF Transformer	10.7 Mc/s ± 400 Kc/s	sweep signal is sent to T.P.-(1) via the 10 pf ceramic condenser.	oscilloscope is connected with T.P.-(3) via the 0.05 μF ceramic condenser.		primary and secondary sides from the 1st IFT(T ₃) to the 4th IFT(T ₆).	Best I.F.T. Wave from
2.	Discriminator	10.7 Mc/s ± 400 Kc/s	sweep signal is sent to T.P.-(2) via the 0.05 μF ceramic condenser.	oscilloscope is connected with T.P.-(4) via the 0.1 μF condenser.		FM. Discriminator Transformer Primary and Secondary	S Curve
3.	O.S.C.	88 Mc/s 400 c/s 100% Modulation	Antenna Terminals	Oscilloscope and V.T.V.M. at output load	88 Mc/s	O.S.C. coil L ₁	Maximum
4.	O.S.C.	108 Mc/s 400 c/s 100% Modulation	Antenna Terminals	Oscilloscope and V.T.V.M. at output load	108 Mc/s	O.S.C. Trimmer TC-3	Maximum
5.		Reiterate 3. 4					
6.	RF Amp.	90 Mc/s 400 c/s 100% Modulation	Antenna Terminals	Oscilloscope and V.T.V.M. at output load	90 Mc/s	RF Amp. Transformer T ₂	Maximum
7.	Antenna circuit	90 Mc/s 400 c/s 100% Modulation	Antenna Terminals	Oscilloscope and V.T.V.M. at output load	90 Mc/s	Antenna Transformer T ₁	Maximum
8.	RF Amp.	106 Mc/s 400 c/s 100% Modulation	Antenna Terminals	Oscilloscope and V.T.V.M. at output load	106 Mc/s	RF Amp. Trimmer TC-2	Maximum
9.	Antenna circuit	106 Mc/s 400 c/s 100% Modulation	Antenna Terminals	Oscilloscope and V.T.V.M. at output load	106 Mc/s	Antenna circuit Trimmer TC-1	Maximum
10.		Reiterate 6, 7, 8, 9					

AM ALIGNMENT PROCEDURE

STEP	ALIGN	GENERATOR	FEED SIGNAL	OUTPUT INDICATOR	DIAL SETTING	ADJUST	ADJUST FOR
1.	IF Transformer	455 Kc/s ±30 Kc/s sweep generator	Antenna Terminals	Oscilloscope and V.T.V.M. at TP-⑤		Primary and secondary sides from the 1st IFT(T ₁₀) to the 4th IFT(T ₁₃)	Best I.F.T. Wave form
2.	O.S.C.	AM-generator 535 Kc/s 400 c/s 30% Modulation	Antenna Terminals	Oscilloscope and V.T.V.M. at output load	535 Kc/s	O.S.C. Transformer T ₈	Maximum
3.	O.S.C.	AM-generator 1600 Kc/s 400 c/s 30% Modulation	Antenna Terminals	Oscilloscope and V.T.V.M. at output load	1600 Kc/s	O.S.C. Trimmer TC-6	Maximum
4.		Reiterate 2, 3					
5.	RF Amp.	AM-generator 600 Kc/s 400 c/s 30% Modulation	Antenna Terminals	Oscilloscope and V.T.V.M. at output load	600 Kc/s	RF Transformer T ₉	Maximum
6.	Antenna circuit	AM-generator 600 Kc/s 400 c/s 30% Modulation	Antenna Terminals	Oscilloscope and V.T.V.M. at output load	600 Kc/s	Ferrite bar Antenna at coil L ₃	Maximum
7.	RF Amp.	AM-generator 1400 Kc/s 400 c/s 30% Modulation	Antenna Terminals	Oscilloscope and V.T.V.M. at output load	1400 Kc/s	RF Trimmer TC-5	Maximum
8.	Antenna circuit	AM-generator 1400 Kc/s 400 c/s 30% Modulation	Antenna Terminals	Oscilloscope and V.T.V.M. at output load	1400 Kc/s	Antenna circuit Trimmer TC-4	Maximum
9.		Reiterate 5, 6, 7, 8					

FM M.P.X. ALIGNMENT PROCEDURE

1. Do not attempt to align the Multiplex Circuit unless the following equipment is available :

- a. Multiplex Stereo Generator b. Oscilloscope c. AC. V.T.V.M. d. Audio oscillator e. FM Signal Generator

STEP	ALIGN	GENERATOR	FEED SIGNAL	OUTPUT INDICATOR	ADJUST	ADJUST FOR
1.	67 Kc/s Trap	67 Kc/s Audio Signal	Connect to T.P.-⑥	V.T.V.M. at T.P.-⑦	L ₅	Minimum
2.	19 Kc/s Transformer	FM Signal Gen. Modulated 30% by Stereo Gen. sub-channel	Antenna Terminals Tune to signal	V.T.V.M. and Oscilloscope at T.P.-⑧	T ₁₄	Maximum
3.	19 Kc/s Transformer	FM Signal Gen. Modulated 30% by Stereo Gen. sub-channel	Antenna Terminals Tune to signal	V.T.V.M. and Oscilloscope at T.P.-⑧	T ₁₅	Maximum
4.	38 Kc/s Transformer	FM Signal Gen. Modulated 30% by Stereo Gen. sub-channel	Antenna Terminals Tune to signal	V.T.V.M. and Oscilloscope at T.P.-⑧	T ₁₆	Maximum
5.	19 Kc/s Transformer and Separation VR	FM Signal Gen. Modulated 30% by Stereo Signal Gen. channel-L	Antenna Terminals Tune to signal	V.T.V.M. and Oscilloscope at output load channel-R	19Kc/s Transformer (T ₁₅) and Separation VR-2	channel-R Minimum

PARTS LAYOUT

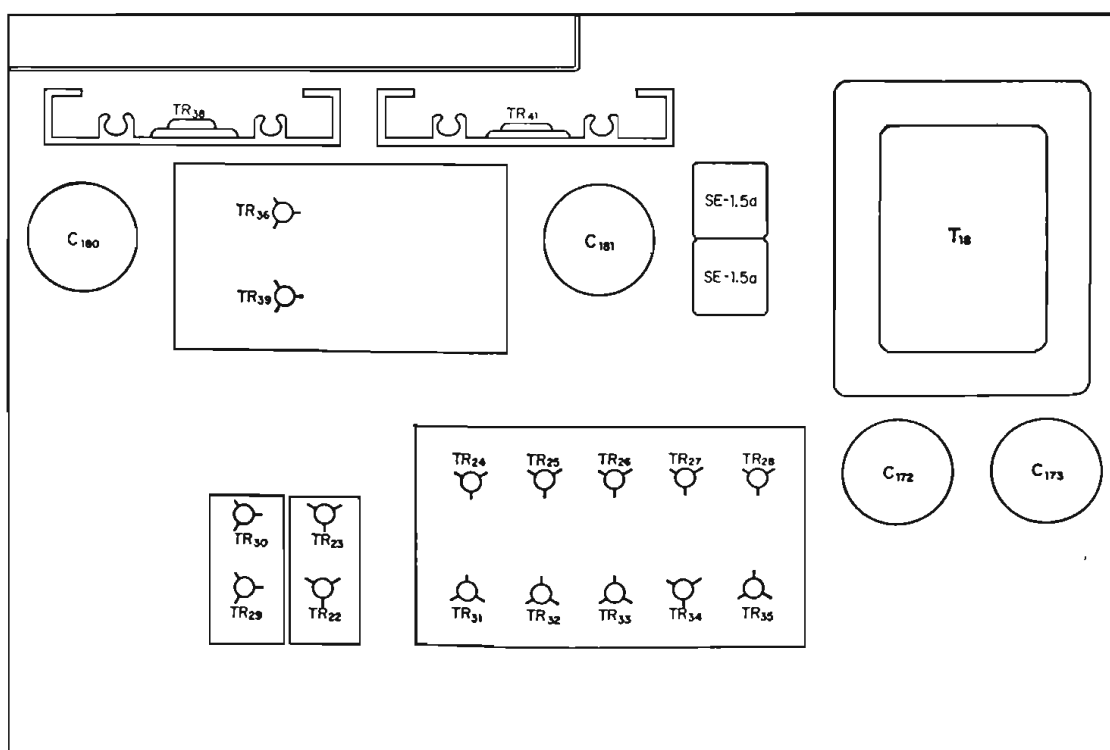
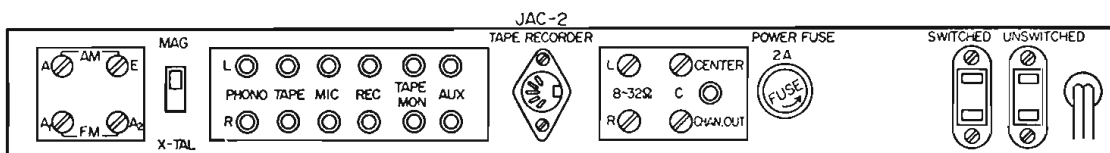
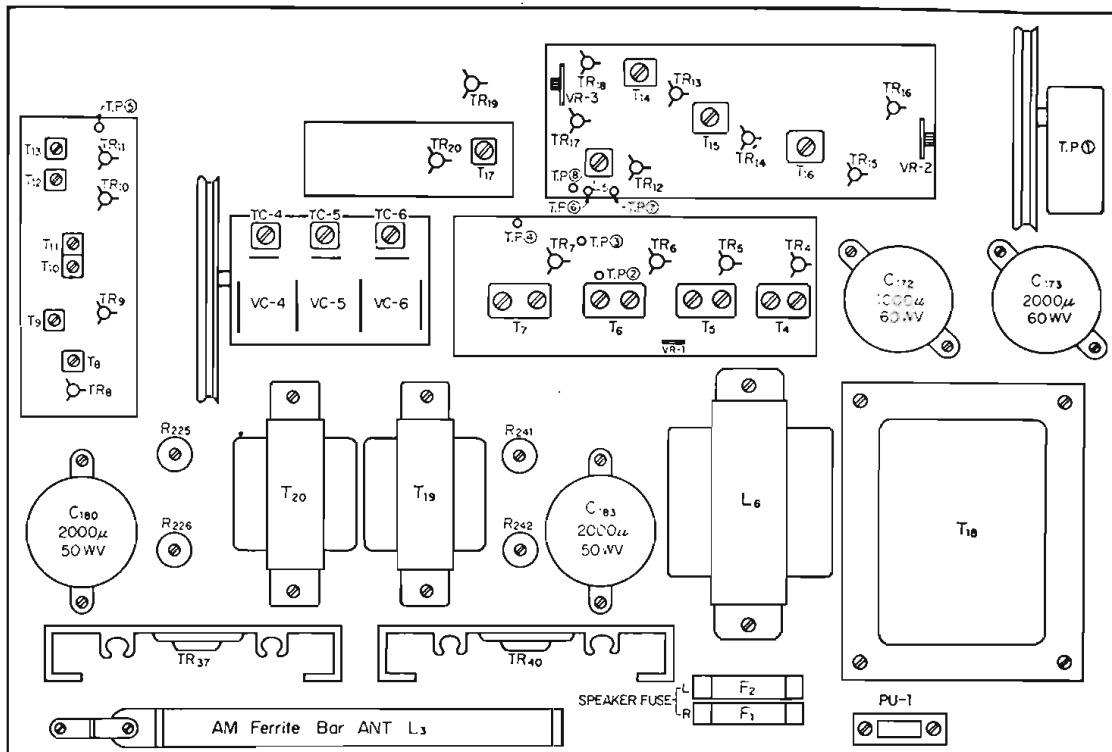

SCHEMATIC DIAGRAM

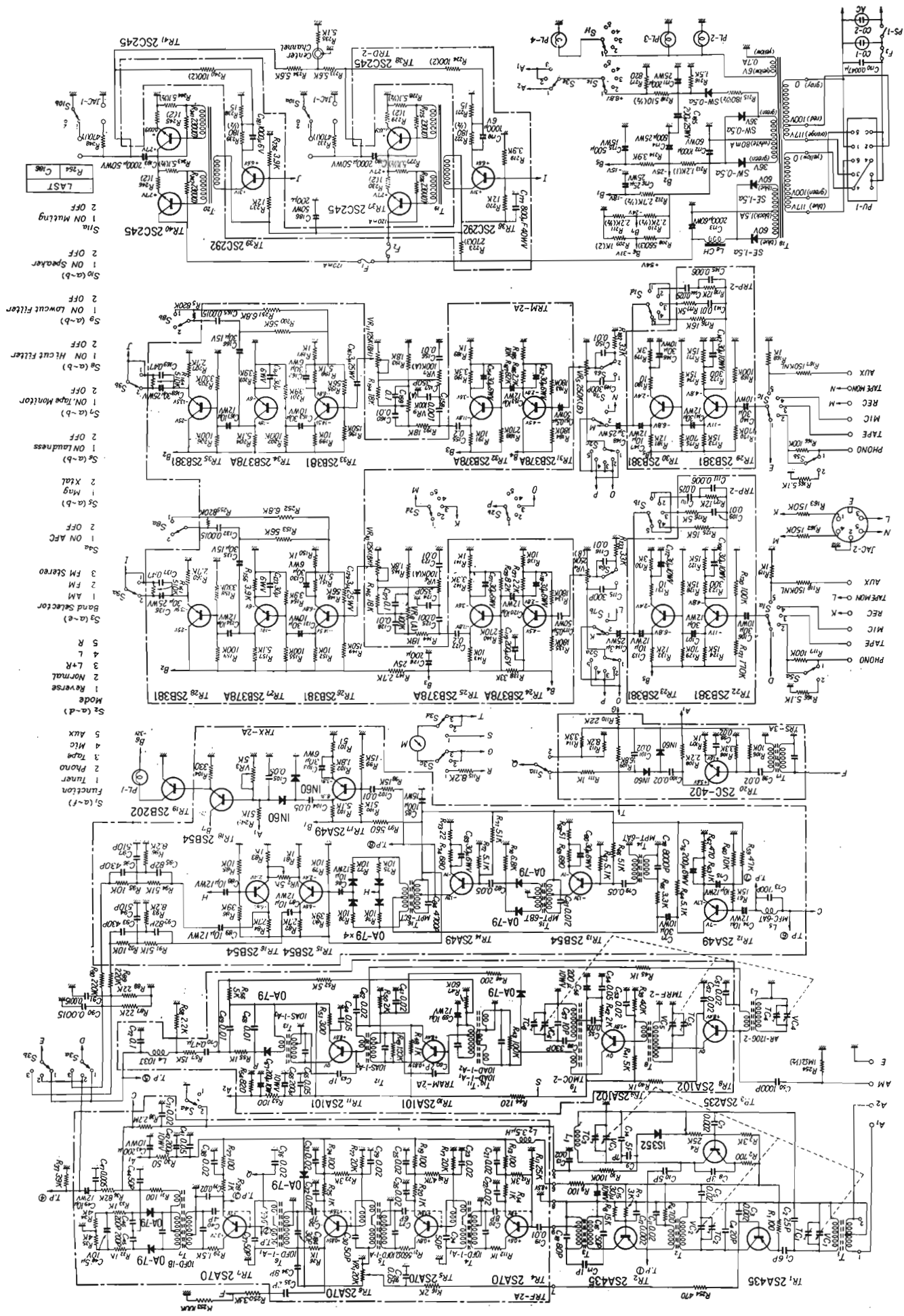

- S1(a-f) Function: 1 Tuner, 2 Phono, 3 Tone, 4 Mic, 5 Aux
 S2(a-d) Mode: 1 Reverse, 2 Normal, 3 L-R, 4 L, 5 R
 S3(a-e) Band Selector: 1 AM, 2 FM, 3 FM Stereo
 S4(a) 1 ON AFC, 2 OFF
 S4(a-b) 1 Mrg, 2 Xtd
 S4(a-b) 1 ON Loudness, 2 OFF
 S4(a-b) 1 ON Tap Monitor, 2 OFF
 S4(a-b) 1 ON HiCut Filter, 2 OFF
 S4(a-b) 1 ON LowCut Filter, 2 OFF
 S5(a-b) 1 ON Speaker, 2 OFF
 S5(a) 1 ON Muting, 2 OFF
 S5(b) LAST

25

26

REMOVALS DISASSEMBLE DIAL CORD STATIONS

DISASSEMBLE REMOVALS

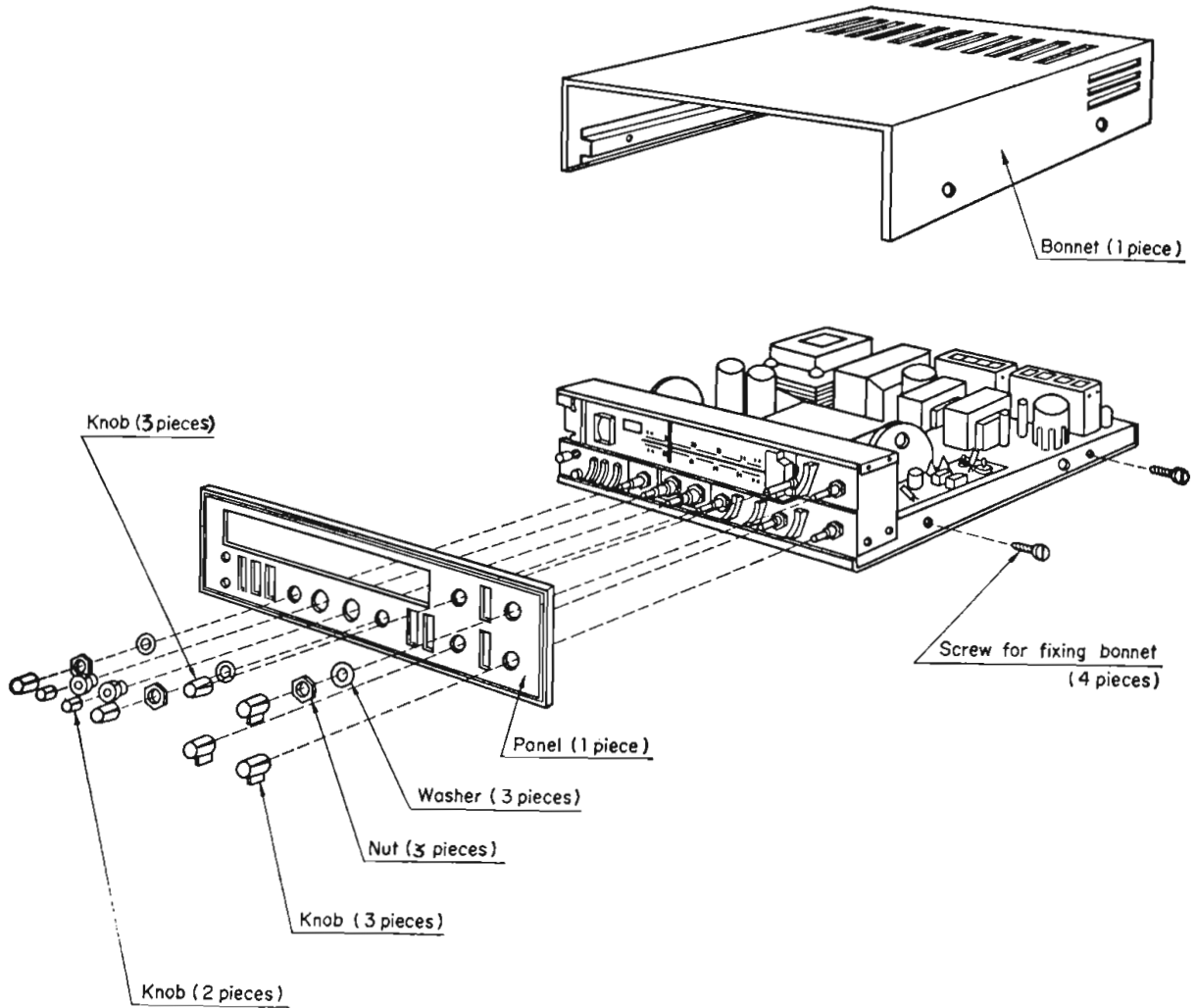

DIAL CORD STRINGS

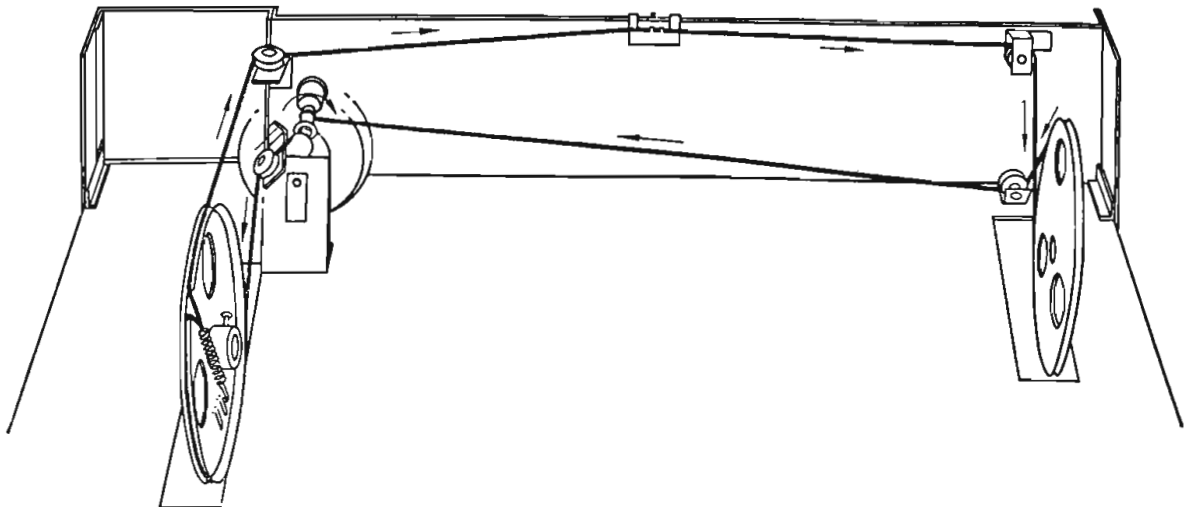

The Sansui logo consists of the word "Sansui" in a white, italicized serif font, set against a solid black rectangular background.

SANSUI ELECTRIC COMPANY LIMITED

Head Office; 14-1, 2-chome, Izumi, Suginami-ku, Tokyo, Japan. TEL. 323-1111

Printed in Japan (51200M12)