

OPERATING INSTRUCTIONS & SERVICE MANUAL

SOLID-STATE AM/FM STEREO TUNER

SANSUI TU-666

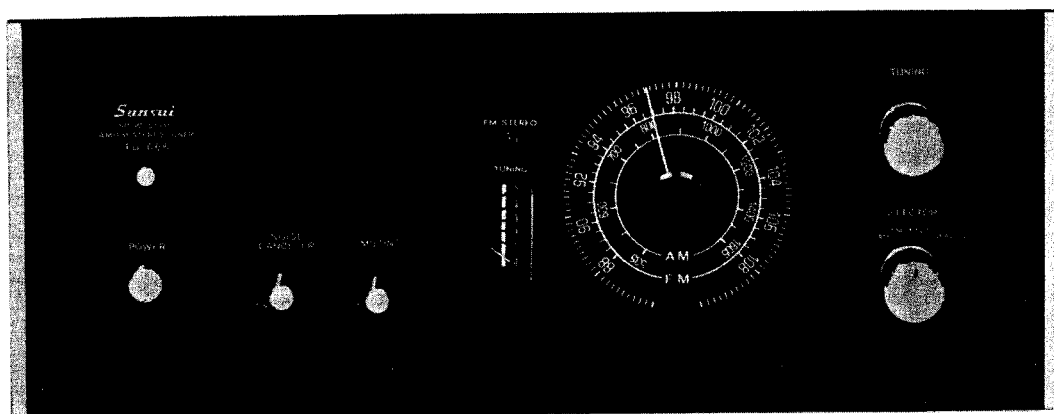

Sansui

SANSUI ELECTRIC CO., LTD.

Congratulations, you are now the owner of the new Sansui TU-666 solid state stereo tuner built for exceptional performance by the world's foremost audio-only specialist. Designed specifically for FM enthusiasts, the TU-666 will pull in an increasing number of FM stations more clearly in either strong signal areas or fringe locations. Its highly sensitive FET front end and IC-equipped i.f. strip show a new degree of selectivity by permitting weak signals to be tuned without being blanketed by adjacent strong signals. In the AM section, the exclusive ceramic filter upgrades its performance characteristics. The refined dull black panels are common to all AU series professional control amplifiers from Sansui.

From the superior performance characteristics to the careful finish of panels, Sansui's tradition of quality is evident. Packed with the most advanced circuits throughout, The TU-666 comes to you with the full confidence and guarantee of the manufacturer. It is now up to you to read the contents of this manual carefully before setting out to use it, so you may operate it correctly and obtain the maximum performance it is capable of offering for many years to come.

CONTENTS

OPERATING INSTRUCTIONS

SWITCHES AND CONTROLS.....	3
CONNECTIONS	4
ANTENNA CONNECTIONS / OPERATIONS.....	5
MAINTENANCE.....	6
SPECIFICATIONS / CHARACTERISTICS	7

SERVICE MANUAL

DISASSEMBLY PROCEDURE.....	8
BLOCK DIAGRAM	9
ALIGNMENT.....	10, 11, 12, 13
PRINTED CIRCUIT BOARDS AND PARTS LIST	
.....	14, 15, 16, 17, 18, 19
ACCESSORIES LIST.....	19
OTHER PARTS AND THEIR POSITION ON CHASSIS	
.....	19, 20
GENERAL TROUBLESHOOTING CHART	21, 22

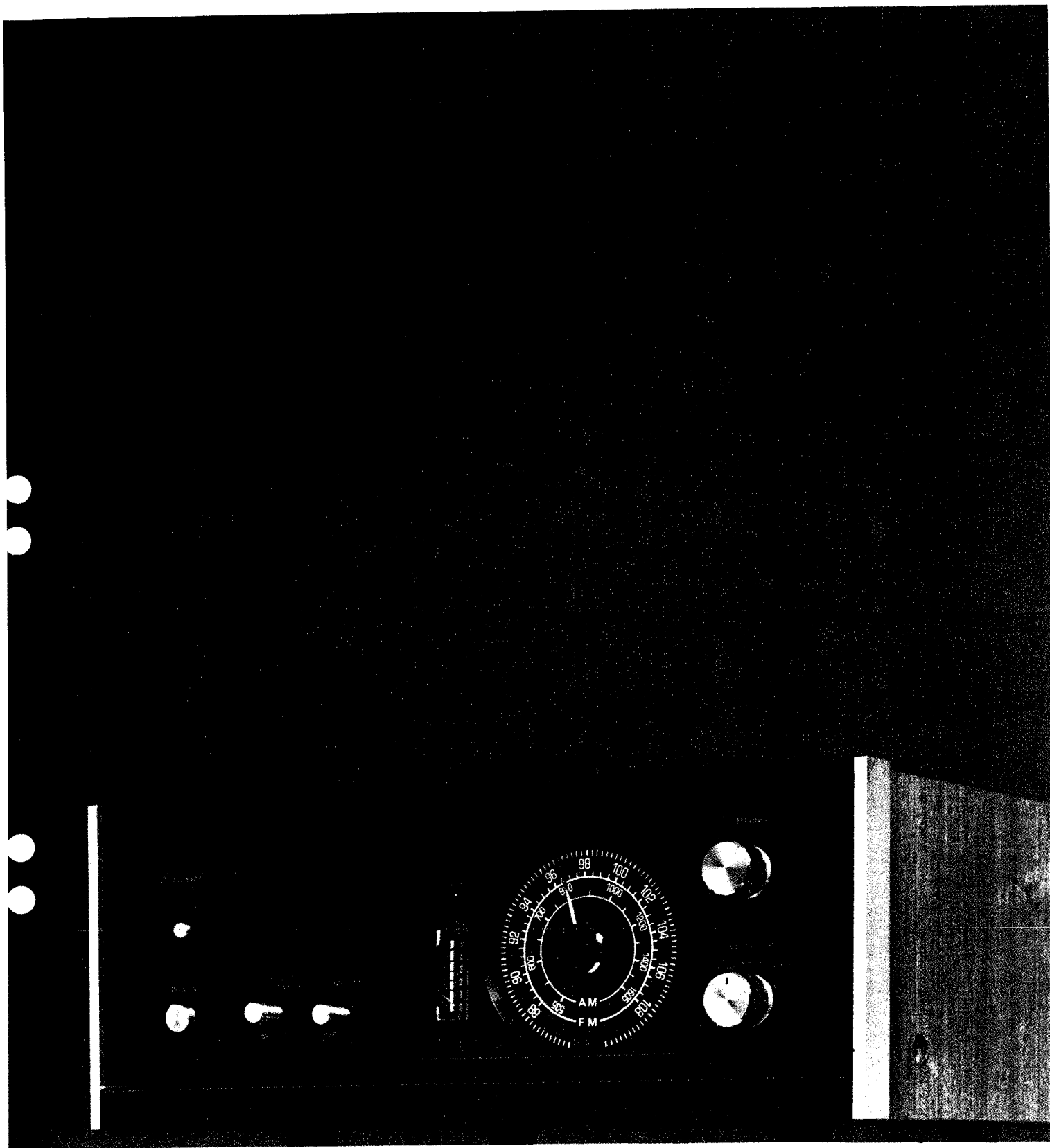

SWITCHES AND CONTROLS

FM Stereo Indicator

The stereo indicator light glows when a stereo program is received or when the dial pointer crosses a station making an FM stereo broadcast. During mono reception, it remains unlit.

Power Indicator

Lights up whenever the tuner is receiving current. Remains lit as long as the power switch is ON.

Tuning Meter

This meter aids in pinpointing either AM or FM station; when the needle swings to the maximum upward position (but not necessarily to "5"), the station is correctly tuned.

Tuning Knob

Use this knob to select your desired AM or FM station by watching the tuning meter.

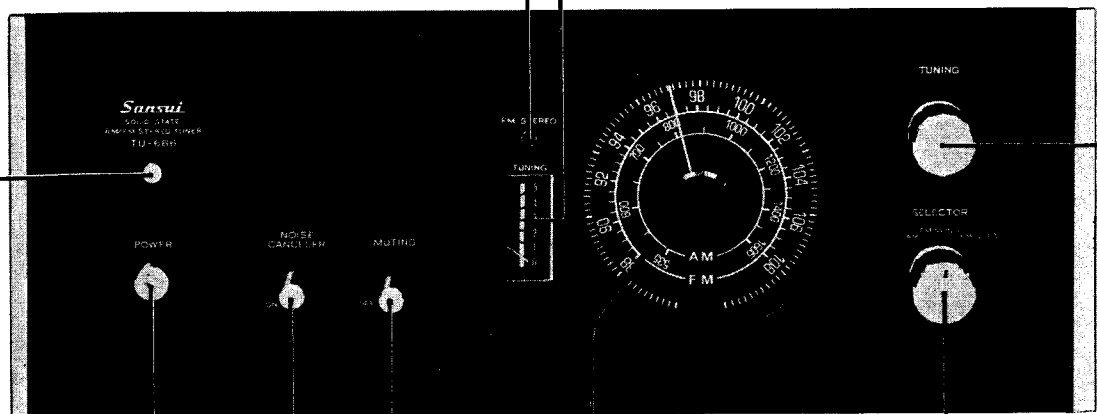

Power Switch

Push this switch to turn the power on; push again to turn the power off.

Noise Canceler Switch

This switch is used to eliminate annoying noise on FM multiplex programs transmitted by distant or weak stations without weakening the treble tones in the music being played. When this switch is on, the TU-666's stereo separation may be slightly reduced. Unless such noise is heard, this switch should not be used.

Selector Switch

AM—Use this position for all AM programs.
FM MONO—Use this position for all FM monophonic programs.
FM AUTO—Use this position for automatic FM stereo/mono switching.

Dial Scales

The outer dial scale is for FM, the inner for AM.

Muting Switch

This switch is used to eliminate interstation noise for quiet FM station selection. When this switch is on, weak or distant stations may also be suppressed. To tune weak or distant stations, keep this switch in the OFF position.

CONNECTIONS

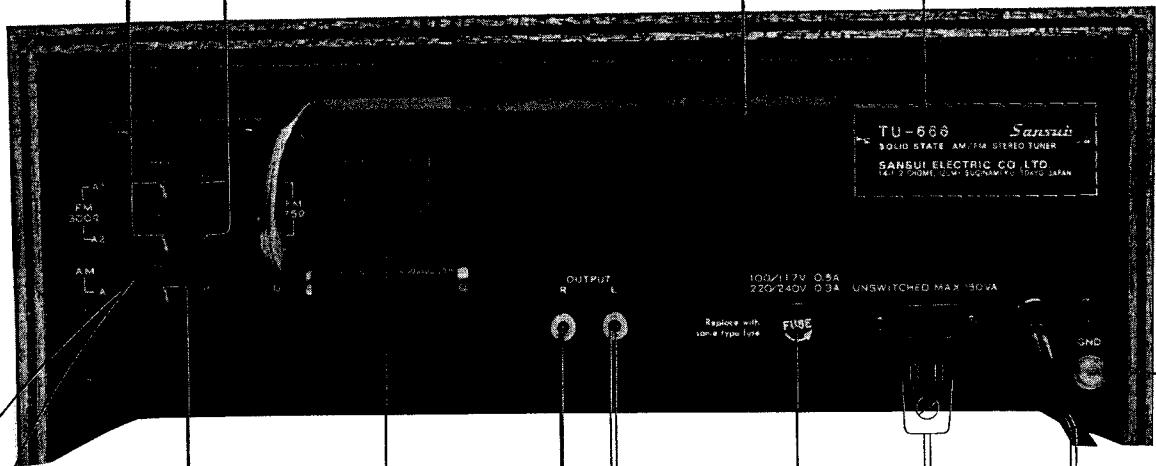
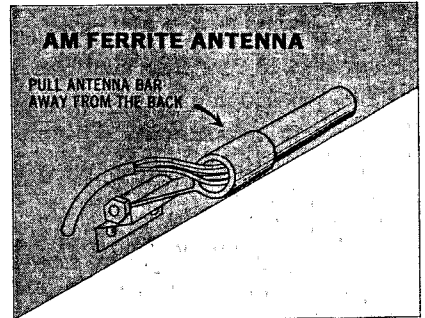
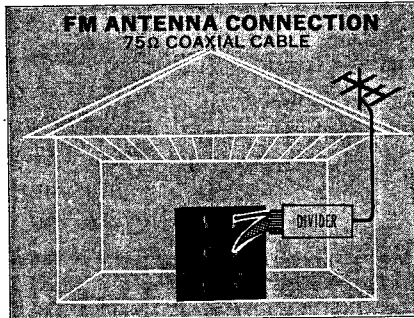
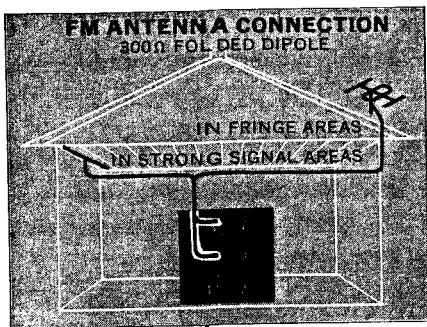

LOCAL-DISTANT ANTENNA SWITCH

POWER FUSE

TO TAPE DECK OR OTHER COMPONENTS

GROUNDING

WALL OUTLET

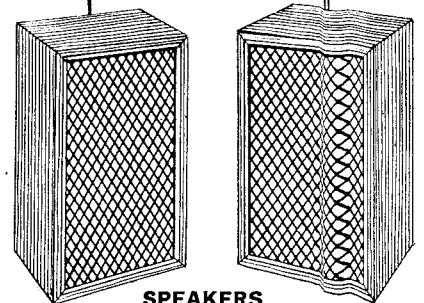
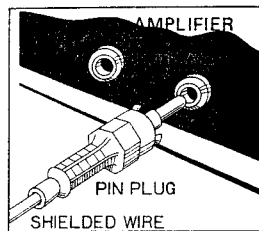
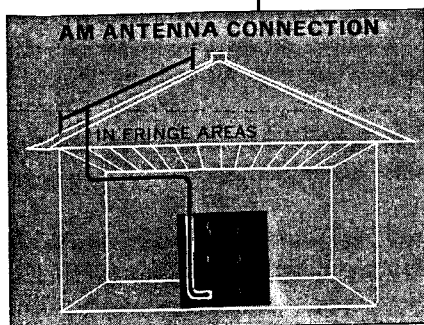
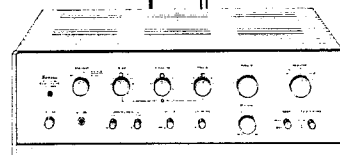

ANTENNA CONNECTIONS / OPERATIONS

ANTENNA CONNECTION

The quality of reception that can be expected from the TU-666 depends largely on the correct positioning and use of antennas. To pull in more stations more clearly, the following procedures are recommended:

Built-in AM Ferrite Antenna

This highly sensitive antenna, located on the rear panel of the tuner, is usually adequate for AM reception in many areas. To use, pull it down and away from the back of the tuner until the best reception is obtained.

Outdoor AM Antenna

In ferroconcrete buildings or in fringe areas, the built-in ferrite antenna may be inadequate for reception of weak or distant stations. An outdoor antenna then becomes necessary. This can be accomplished by connecting the PVC wire supplied with the set to the antenna terminal marked AM-A on the rear panel. Run this wire to an antenna that has been placed outside a window or mounted on a roof. At the same time, the unit should be grounded. Position the outdoor antenna where reception is strongest while actually receiving a broadcast. And, for reasons of safety, be sure to attach a lightning arrester to the outdoor antenna.

Indoor FM Antenna

In urban or strong signal areas, satisfactory FM reception can be obtained by using the folded dipole antenna (300 ohm) supplied with the TU-666. Connect the two leads from the dipole to the terminals marked FM 300Ω A1 and A2 on the rear panel and tack the dipole up on the wall in the form a T. Be sure to position the dipole for best signal reception before the antenna is permanently tacked up on the wall.

Outdoor FM Antennas

In ferroconcrete buildings or in fringe areas, the indoor dipole antenna may be inadequate for reception of weak or distant FM stations. An outdoor antenna designed specifically for FM should then be installed.

Either a balanced 300 ohm or unbalanced 75 ohm antenna can be used with the TU-666. If the 300 ohm twin-lead is used, connect it to the terminals marked FM 300Ω A₁ and A₂ on the rear panel

just like the indoor dipole antenna connection. If the 75 ohm coaxial cable is used, connect the center conductor to the FM 75Ω A terminal and the shielding wire to the G terminal.

Note: FM sensitivity cannot be raised simply by lengthening the antenna. Adjust the antenna's height and direction while actually listening to a broadcast for best reception.

AMPLIFIER CONNECTION

To connect a control amplifier to the TU-666, use the two cables supplied with the tuner. Connect the R output on the rear panel of the tuner to the right channel input marked TUNER or AUX on the rear of the amplifier. The left channel connection are made between the L output of the tuner and the left TUNER or AUX input of the amplifier.

OPERATIONS

To Listen to an AM Program

1. Set the SELECTOR switch to the AM position.
2. Select your desired station on the AM band of the tuning dial with the TUNING knob. The station is properly tuned when the needle in the tuning meter swings to the maximum upward position.

Note: While the scale of the tuning meter is graduated from 1 to 5, the needle need not move all the way to "5" to indicate optimum reception.

To Listen to an FM Program

1. Set the SELECTOR switch to the FM AUTO position. If too much noise or interference accompanies a stereo program with the SELECTOR switch in the FM AUTO position, turn it to the FM MONO position and listen to the program monophonically.
2. Set the MUTING switch to the ON position.
3. Select your desired position on the FM band of the tuning dial with the TUNING knob. The station is properly tuned when the needle in the tuning meter swings to the maximum upward position.
4. Set the NOISE CANCELER to the ON position if annoying noise accompanies the FM stereo program.
5. For FM stereo reception, the mode switch of the control amplifier must be in the STEREO position.

MAINTENANCE

Local-Distant Antenna Switch

This switch is used to attenuate very strong signals to avoid overloading. In strong signal areas, this switch should be set to LOC. In other locations, this switch should be set to DIST.



Ventilation

Adequate air circulation is absolutely essential for proper operation. The enclosure should be open at the rear, and should provide at least 1½ in. of free space above the TU-666 for air circulation. Nothing must be placed directly on the top of the tuner.

AC Outlet

One AC outlet on the rear panel is used to serve as power supply source for a tape deck or other components. This outlet has a maximum rating of 150 VA.

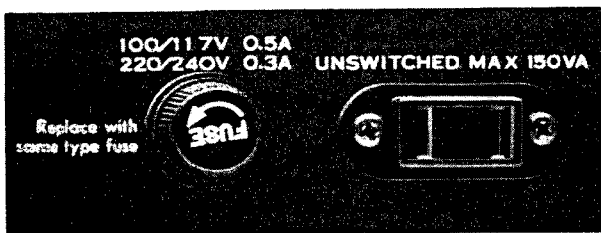

Power Fuse

Should the tuner fail to operate when the POWER switch is pushed on, the probable cause is either a power stoppage or a blown fuse. To check, remove the TU-666's power cord from its outlet, turn the fuse holder on the rear panel counterclockwise, and remove the fuse. If it is blown, replace it with a new glass-tubed fuse of the same capacity (100~117-0.5A, 220~240V-0.3A) after determining and eliminating the trouble source that caused the fuse to blow. Using wire or a fuse of a different capacity as a stop-gap measure is dangerous and should be avoided.

Grounding

Connect a vinyl or enameled wire from the terminal screw marked GND or AM-G to a copper plate buried underground or to a water pipe. Whenever an outdoor AM antenna is used, grounding becomes necessary.

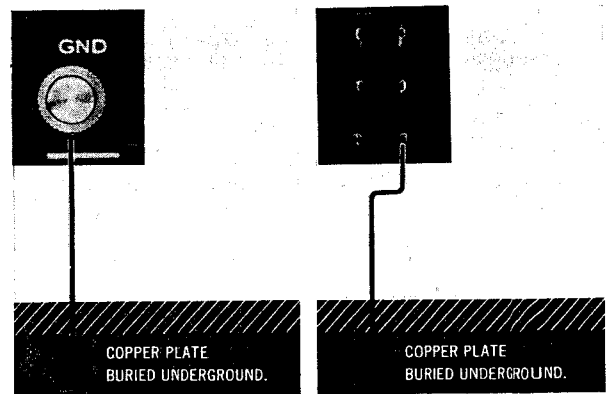

Voltage Adjustment

To reach the voltage selector, remove the two screws from the nameplate on the rear panel and then remove the nameplate. The voltage selector makes it possible to operate the TU-666 at the correct voltage in any area. The voltage has been pre-adjusted at the factory, but can be easily re-adjusted as follows:

STEP I Set arrow of voltage selector plug to required voltage: 100, 117, 220, or 240 volts.

STEP II The power fuse should also be changed whenever the AC line voltage is changed. For 100-117 volt operation a 0.5 ampere fuse is required. For 220-240 volt operation the fuse should be changed to a 0.3 ampere unit.

NOTE: The voltage selector can be used to eliminate the trouble caused by the considerable voltage fluctuation. In this case, it should be set to the peak voltage.

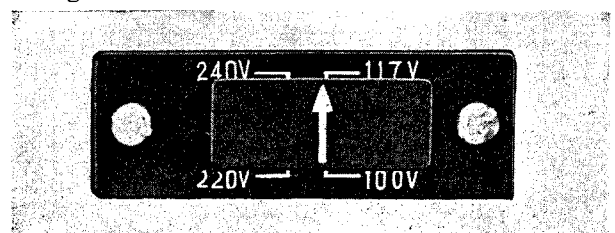

SPECIFICATIONS / CHARACTERISTICS

FM SECTION

TUNING RANGE: 88 to 108MHz
SENSITIVITY: (20dB quieting) 2 μ V (IHF) 2.5 μ V
TOTAL HARMONIC DISTORTION: less than 0.8%
SIGNAL TO NOISE RATIO: better than 65dB
SELECTIVITY: better than 45dB
CAPTURE RATIO (IHF): 3dB
IMAGE FREQUENCY REJECTION: better than 55dB
IF REJECTION: better than 60dB
SPURIOUS RESPONSE REJECTION:

STEREO SEPARATION: better than 60dB
SPURIOUS RADIATION: better than 35dB at 400Hz
ANTENNA INPUT IMPEDANCE: 300 ohms balanced, 75 ohms unbalanced
AM SECTION
TUNING RANGE: 535 to 1,605kHz
SENSITIVITY: 150 μ V at 1,000kHz (bar antenna)
IMAGE FREQUENCY REJECTION: better than 40dB at 1,000kHz
SELECTIVITY: better than 25dB
OUTPUT: 0.7V

CONTROLS AND SWITCHES:

SELECTOR: AM, FM MONO, FM AUTO
FM MUTING: ON, OFF
MPX NOISE CANCELER: OFF, ON
FM ANT SWITCH: LOCAL, DISTANT
SEMICONDUCTORS: TRANSISTORS: 23 FET: 1 DIODES: 19 IC: 1
POWER REQUIREMENTS: POWER VOLTAGE: 100, 117, 220, 240V, 50/60Hz
POWER CONSUMPTION: 15W
DIMENSIONS: 13 $\frac{1}{4}$ "(335mm)W, 5"(127mm)H, 10 $\frac{3}{8}$ "(278mm)D
WEIGHT: 11 lbs. (5kg)

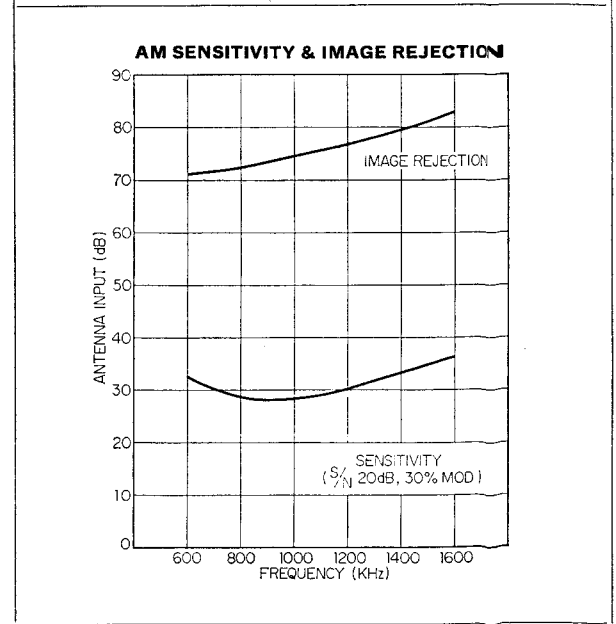
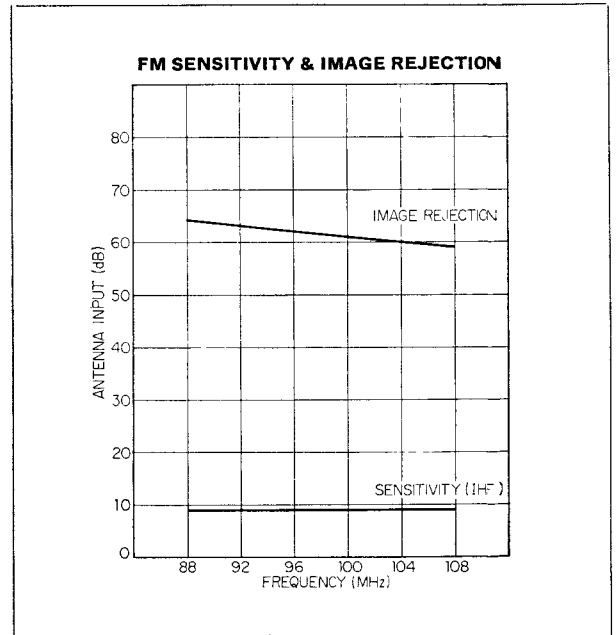
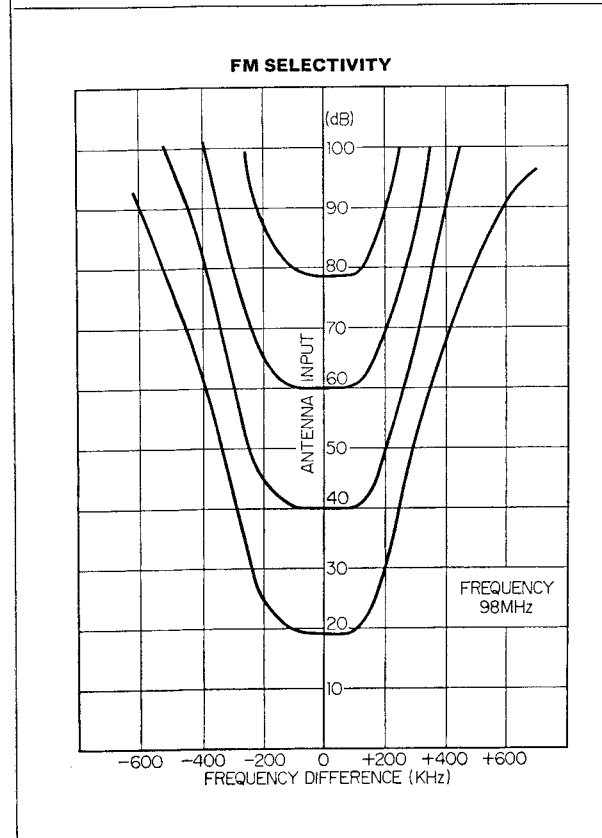
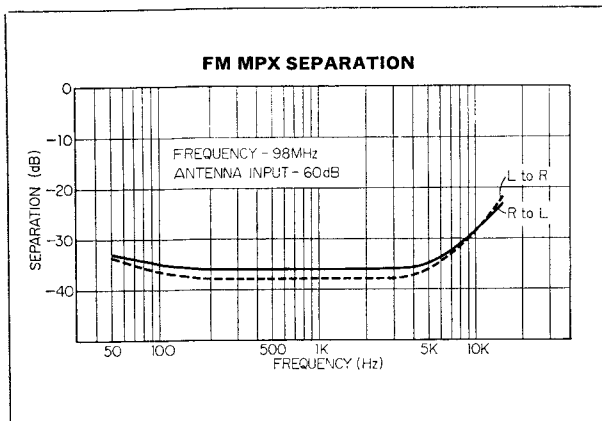

DISASSEMBLY PROCEDURE

REMOVING THE FRONT PANEL, WOOD CASE AND BOTTOM PLATE

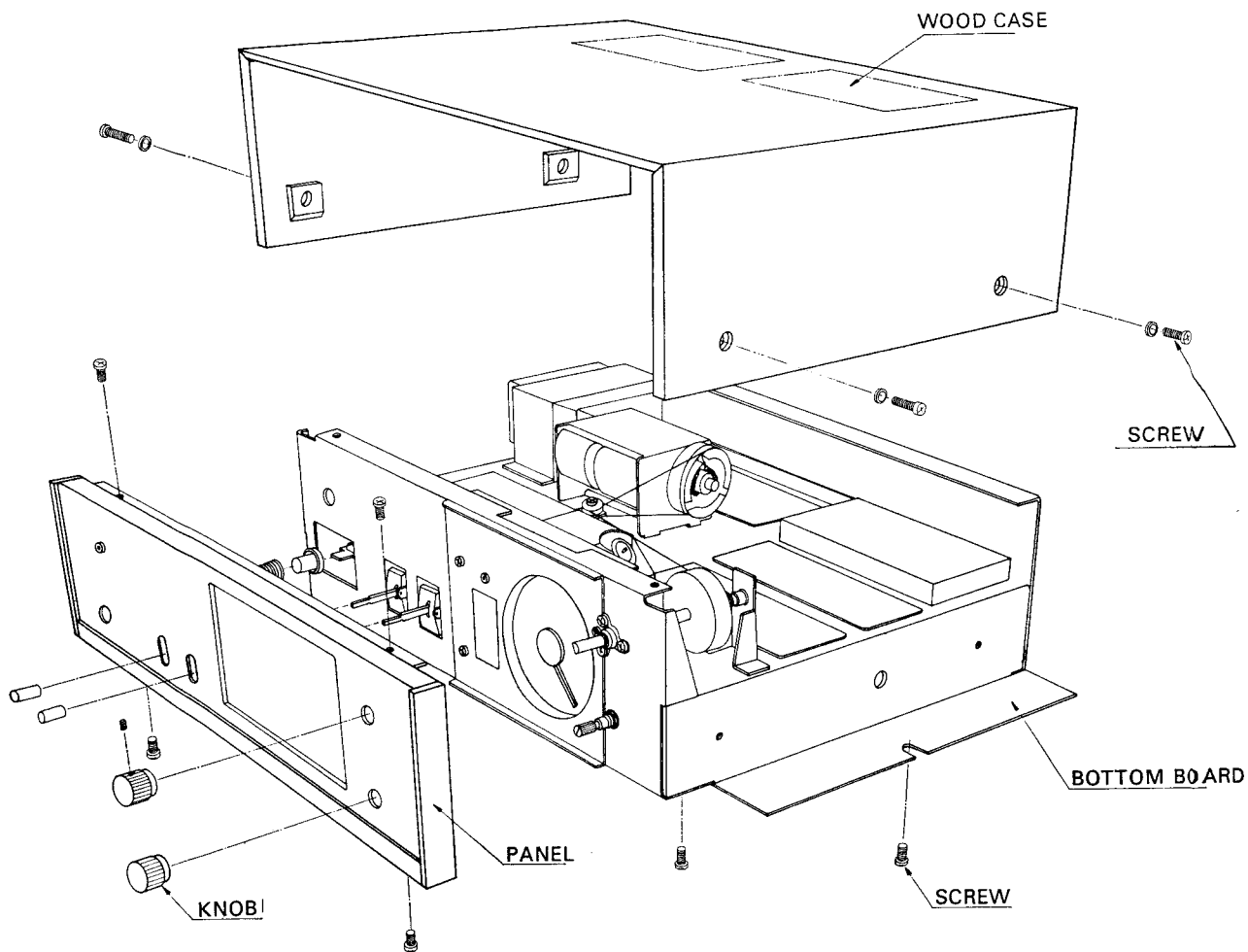

DIAL MECHANISM

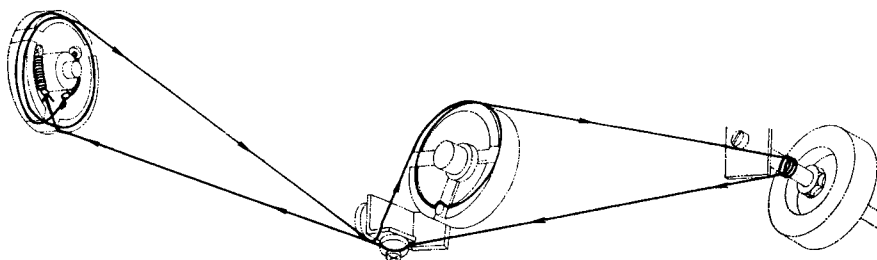

BLOCK DIAGRAM

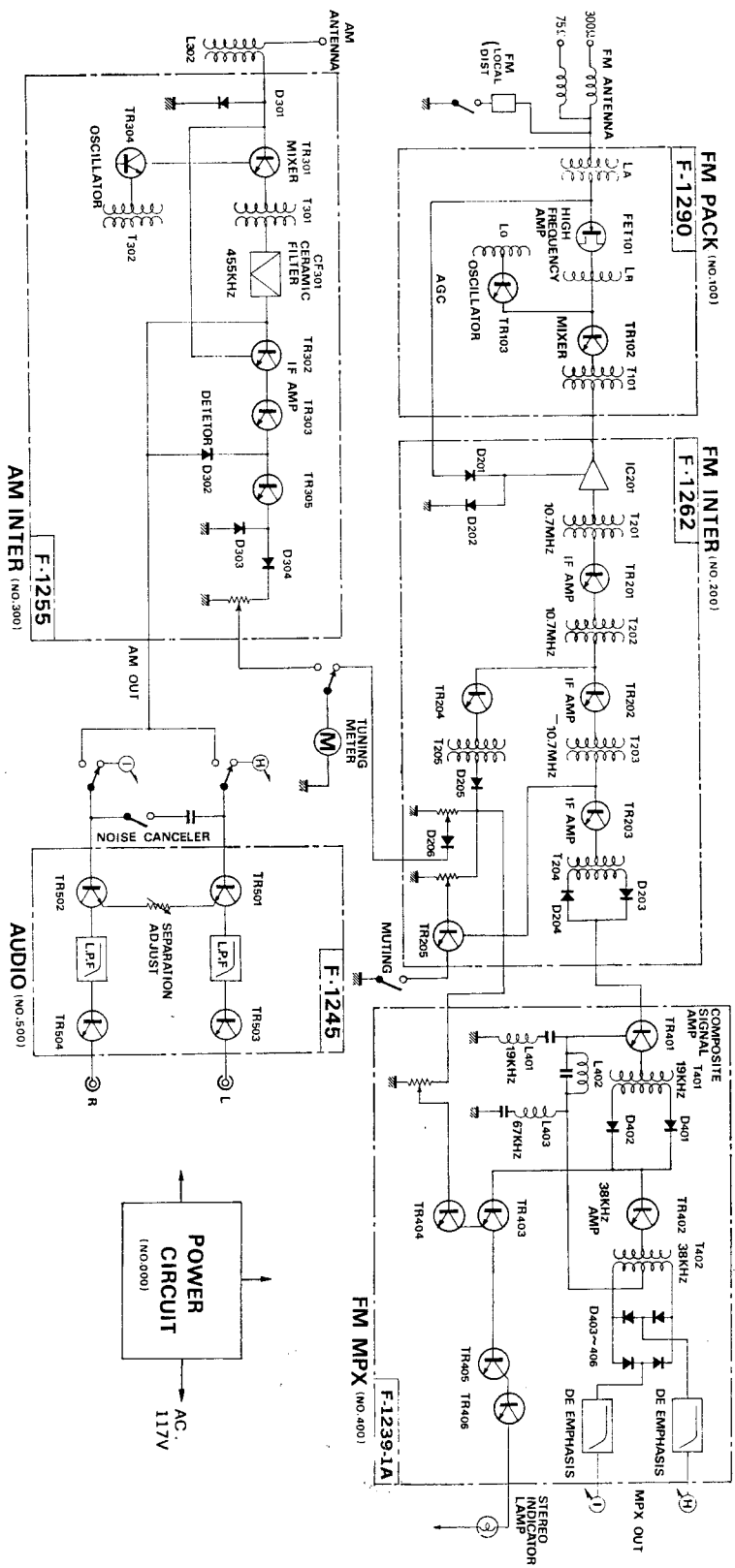

ALIGNMENT

TEST POINTS

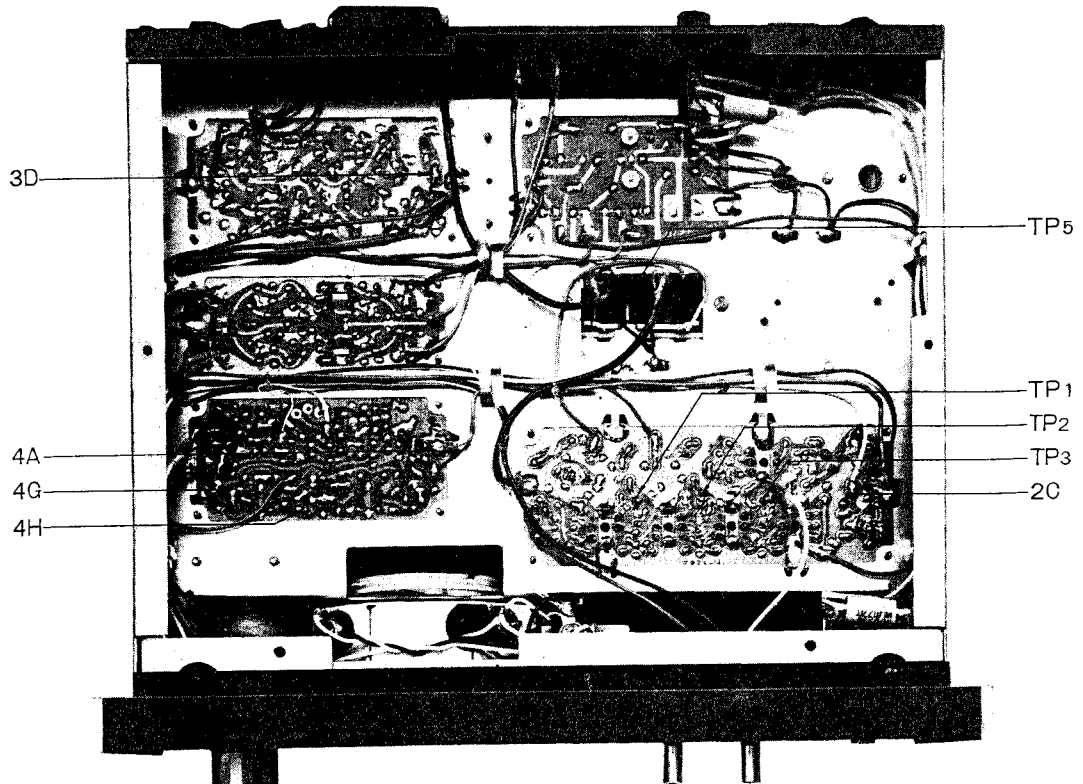
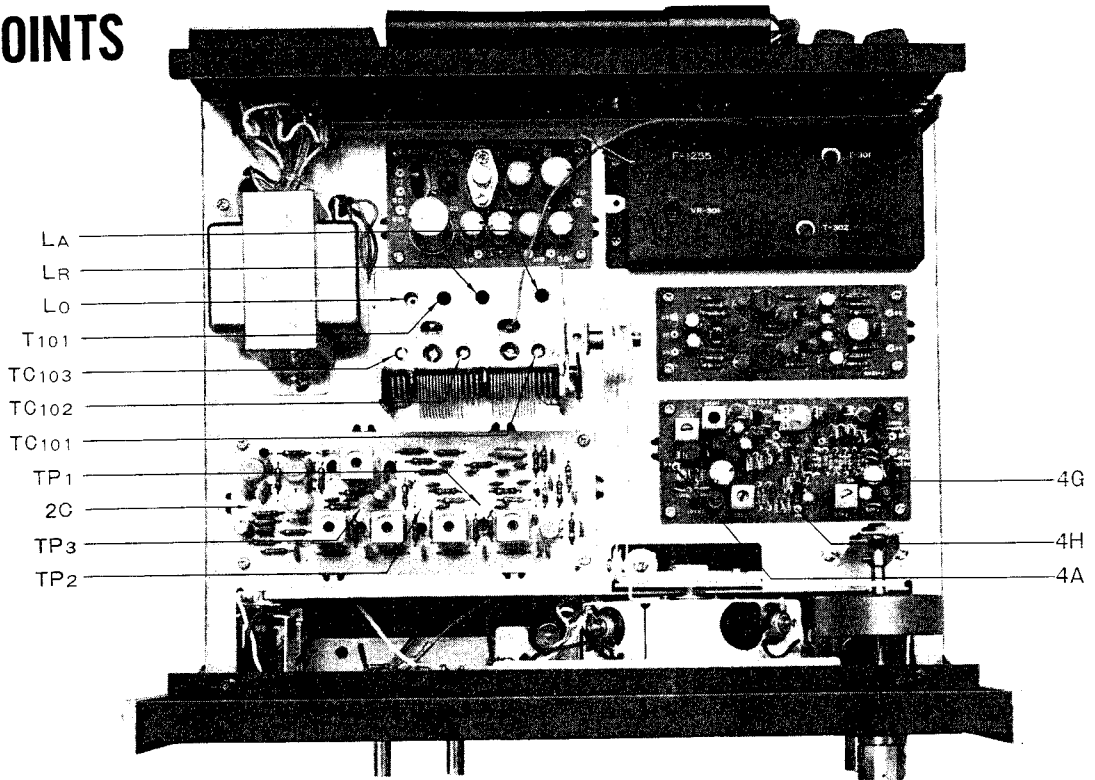

ALIGNMENT

Alignment procedures are summarized in this section. Proper alignment requires use of precision instruments as given below:

1. Sweep generator;
2. Oscilloscope;
3. FM signal generator;
4. Multiplex stereo generator;
5. AC vacuum-tube voltmeter;
6. Audio signal generator;
7. AM signal generator

AM TUNER ALIGNMENT PROCEDURE

STEP	ALIGN	GENERATOR	FEED SIGNAL TO	CONNECT	DIAL SETTING	ADJUST	ADJUST FOR
1.	IF	455 kHz ± 30 kHz sweep generator	Antenna terminals	Oscilloscope to 3D		T ₃₀₁	Best I.F.T. wave form
2.	OSC. (1)	AM signal generator 535 kHz 400 Hz 30% modulation	Antenna terminals	Oscilloscope & V.T.V.M. to output load	535 kHz	OSC. coil (T ₃₀₂)	Maximum
3.	OSC. (2)	1600 kHz 400 Hz 30% modulation	Antenna terminals	Oscilloscope & V.T.V.M. to output load	1600 kHz	OSC. trimmer (PT ₁₀₅)	Maximum
4.	Reiterate 2,3						
5.	Antenna circuit (1)	600 kHz 400 Hz 30% modulation	Antenna terminals	Oscilloscope & V.T.V.M. to output load	600 kHz	Ferrite antenna coil (L ₃₀₂)	Maximum
6.	Antenna circuit (2)	1400 kHz 400 Hz 30% modulation	Antenna terminals	Oscilloscope & V.T.V.M. to output load	1400 kHz	Trimmer (PT ₁₀₄)	Maximum
7.	Reiterate 5,6						

AM IF CHARACTERISTIC

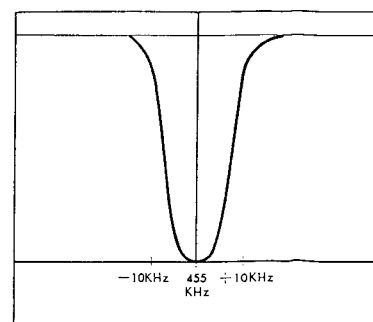

FM TUNER ALIGNMENT PROCEDURE

STEP	ALIGN	SIGNAL GENERATOR	FEED SIGNAL TO	CONNECT	DIAL SETTING	ADJUST	ADJUST FOR
1.	IF transformer	10.7 MHz ±200 kHz sweep generator	TP ₅	Oscilloscope to TP ₅ through 0.02μF ceramic capacitor		Primary and secondary of IF transformer (T ₁₀₁ , T ₂₀₁ , T ₂₀₂ , T ₂₀₃)	Best wave form
2.	Discriminator	10.7 MHz ±200 kHz sweep generator	TP ₅	Oscilloscope to 2C through 0.02μF ceramic capacitor		Primary and secondary of discriminator transformer (T ₂₀₄)	S curve
3.	Local oscillator (1)	FM signal generator 88MHz, 400 Hz, 100% modulation	Antenna terminals	Oscilloscope and V.T.V.M. to load terminal	88 MHz	Local oscillator coil (L ₀)	Maximum
4.	Local oscillator (2)	FM signal generator 108 MHz, 400 Hz, 100% modulation	Antenna terminals	Oscilloscope and V.T.V.M. to load terminal	108 MHz	Local oscillator trimmer (PT ₁₀₃)	Maximum
5.	Reiterate 3 & 4.						
6.	High-frequency amp. circuit (1)	FM signal generator 90 MHz, 400 Hz, 100% modulation	Antenna terminals	Oscilloscope and V.T.V.M. to load terminal	90 MHz	Antenna coil (L _A , L _R)	Maximum
7.	High-frequency amp. circuit (2)	FM signal generator 106 MHz, 400 Hz, 100% modulation	Antenna terminals	Oscilloscope and V.T.V.M. to load terminal	106 MHz	Trimmer (PT ₁₀₁ , PT ₁₀₂)	Maximum
8.	Reiterate 6 & 7.						

FM DISCRIMINATOR CHARACTERISTIC

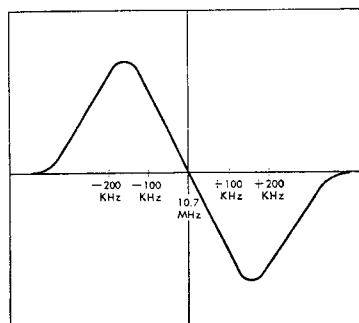

FM IF CHARACTERISTIC

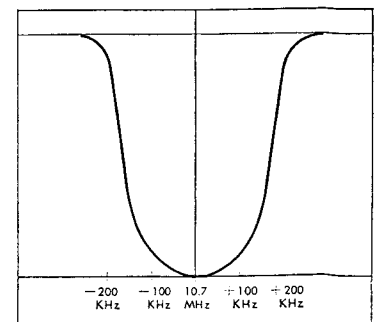

ALIGNMENT

FM MULTIPLEX ALIGNMENT PROCEDURE

STEP	ALIGN	SIGNAL GENERATOR	FEED SIGNAL TO	CONNECT	DIAL SETTING	ADJUST	ADJUST FOR
1.	67 kHz trap	Audio signal generator, 67 kHz 200 mV r.m.s.	4A	V.T.V.M. to 4G		L ₄₀₃	Minimum
2.	19 kHz tuning coil	1) FM signal generator, 98 MHz, 60 dB 2) Stereo signal generator, 30% modulation of composite signal (L or R) including pilot signal	Antenna terminals	V.T.V.M. to 4G	98 MHz	L ₄₀₁ , T ₄₀₃	Maximum
3.	38 kHz tuning coil	1) FM signal generator, 98 MHz, 60 dB 2) Stereo signal generator, 30% modulation of composite signal (L or R) including pilot signal	Antenna terminals	V.T.V.M. to 4G	98 MHz	T ₄₀₂	Maximum
4.	38 kHz tuning coil Separation VR	1) FM signal generator, 98 MHz, 60 dB 2) Stereo signal generator including pilot signal Composite signal L-channel 30% modulation	Antenna terminals	Oscilloscope and V.T.V.M. to load terminals	98 MHz	VR ₅₀₁	1) Observe the wave form of the L channel output and adjust T ₄₀₁ , T ₄₀₂ to maximum output. 2) Adjust the separation VR ₅₀₁ for optimum separation

PRINTED CIRCUIT BOARDS AND PARTS LIST

X: Parts No. Y: Parts Name Z: Position of Parts

FM MPX. <F-1239-1A>

X	Y	Z
R401	1kΩ	1C
R402	100kΩ	1C
R403	15kΩ	1C
R404	22kΩ	1C
R405	68kΩ	1C
R406	100kΩ	1B
R407	100kΩ	1, 2 B
R408	4.7kΩ	1B
R409	100kΩ	1B
R410	2.2kΩ	1B
R411	22kΩ	1B
R412	330Ω	1B
R413	220kΩ	1B
R414	47kΩ	1, 2 C
R415	2.2kΩ	2C
R416	47kΩ	2B
R417	22kΩ	2B
R418	22kΩ	2B
R419	3.3kΩ	1, 2 B
R420	4.7Ω	1B
R421	47Ω	1B
R422	220kΩ	2A
R423	10kΩ	1, 2 A
R424	10kΩ	1A
R425	220kΩ	1B
R426	220kΩ	2B
R427	10kΩ	2A
R428	10kΩ	2A
R429	220kΩ	2A
R430	56kΩ	2A
R431	56kΩ	2A
R432	82kΩ	2A
R433	82kΩ	2A
R434	47kΩ	1, 2 B
VR401	200kΩ (B) Indicator Adjust (1032150)	2B
C401	68pF ±10% 50 WV Ceramic Capacitor	1C
C402	10μF 10 WV Electrolytic Capacitor	1C

±10% ¼W Carbon Resistor

X	Y	Z
C403	0.01μF ± 5% 50 WV Styrol Capacitor	1C
C404	0.022μF ±10% 50 WV Mylar Capacitor	1B
C405	4700pF ± 5% 50 WV Styrol Capacitor	1A, B
C406	1μF 50 WV Electrolytic Capacitor	2B
C407	47μF 25 WV Electrolytic Capacitor	1C
C408	0.01μF	2C
C409	2200pF ± 5% 50 WV Styrol Capacitor	2C
C410	270pF	2C
C411	10μF 25 WV Electrolytic Capacitor	1A
C412	1μF 50 WV Electrolytic Capacitor	2C
C413	680pF	1A
C414	680pF ± 5% 50 WV Styrol Capacitor	2B
C415	0.15μF	1A
C416	0.15μF ±10% 50 WV Mylar Capacitor	2A
C417	2200pF	2A
C418	2200pF ± 5% 50 WV Styrol Capacitor	2A
C419	1μF 50 WV Electrolytic Capacitor	2A
TR401	(0305732, 3)	1C
TR402	(0305732, 3)	1B
TR403	2SC711 (F, G) (0305732, 3)	2B
TR404	(0305732, 3)	2B
TR405	2SC733 (Y) (0305371)	2B
TR406	2SC735 (O, Y) (0305640, 1)	1, 2 B
D401	(0310400)	1B
D402	IN34A (0310400)	1B
D403	(0310401)	1A
D404	IN34A (Y) (0310401)	1A
D405	(0310401)	1A
D406	(0310401)	1A
T401	19kHz Coil (4240580)	1B
T402	38kHz Coil (4240600)	1A
L401	19kHz Coil (4240590)	2C
L402	Micro Inductor (4900100)	1, 2C
L403	67kHz Coil (4240410)	2C

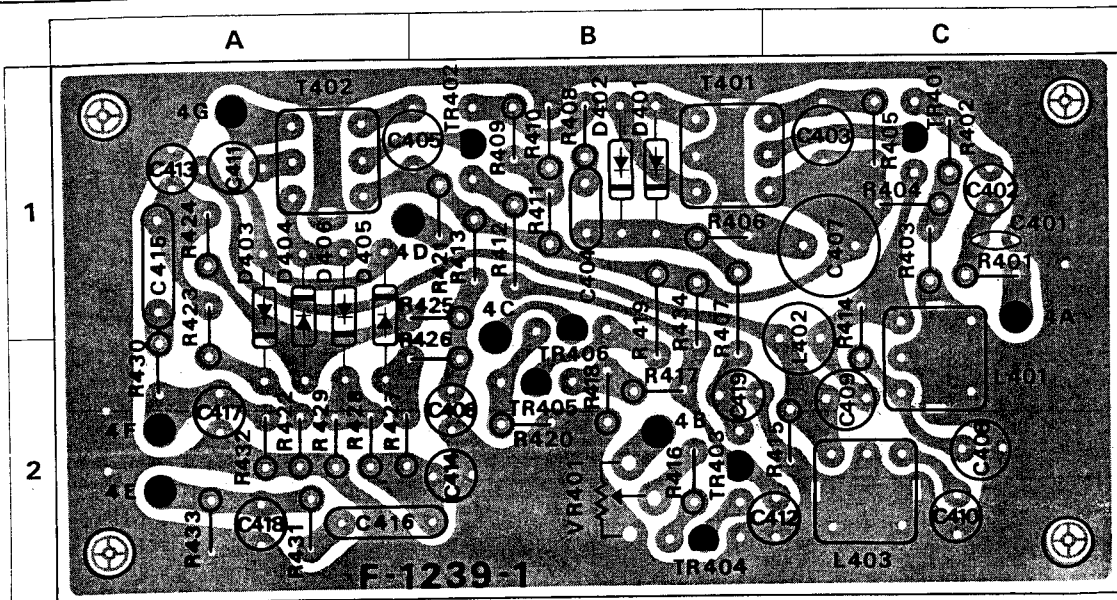

PRINTED CIRCUIT BOARDS AND PARTS LIST

X: Parts No. Y: Parts Name Z: Position of Parts

AM IF <F-1255>

X	Y	Z
R301	2.2kΩ	2A
R302	1kΩ	2A
R303	10kΩ	2A
R304	47kΩ	2A
R305	22kΩ	1A
R306	3.9kΩ	1A
R307	1kΩ	1A
R308	10Ω	1A
R309	180kΩ	2B
R310	2.2kΩ	2B
R311	1kΩ	2A, B
R312	100Ω	1B
R313	1.2kΩ	1, 2B
R314	47kΩ	2B, C
R315	22kΩ	1B
R316	68kΩ	1B
R317	1kΩ	2B, C
R318	1.8kΩ	1B
R319	1kΩ	1C
R320	270Ω	1C
R321	10kΩ	2C
R322	1kΩ	2C
R323	56kΩ	2C
R324	12kΩ	2C
R325	470kΩ	1C

X	Y	Z	
R326	560Ω	1C	
R327	3.3kΩ	±10% 1/4W Carbon Resistor	1C
R328	270Ω		1B
VR301	47kΩ(B) Meter Adjustment (103517)		1C
C301	0.02μF	+100% 25 WV Ceramic Capacitor	2A
C302	0.04μF	-0% 50 WV Mylar Capacitor	1A
C303	3.3μF	50 WV Electrolytic Capacitor	1A
C304	0.04μF	+100% 25 WV Ceramic Capacitor	2A
C305	0.01μF	±10% 50 WV Mylar Capacitor	1A
C306	0.04μF	+100% 25 WV Ceramic Capacitor	1A
C307	0.01μF	±10% 50 WV Mylar Capacitor	1A
C308	470pF	±5% 50 WV Styrol Capacitor	1B
C309	10pF	±10% 50 WV Ceramic Capacitor	1B
C310	0.04μF	+100% 25 WV Electrolytic Capacitor	2B, C
C311	1μF	50 WV Electrolytic Capacitor	2B
C312	0.04μF		2B
C313	0.02μF		2B
C314	0.04μF	+100% 25 WV Ceramic Capacitor	2C
C315	0.02μF		2C
C316	0.0047μF	±10% 50 WV Mylar Capacitor	2C

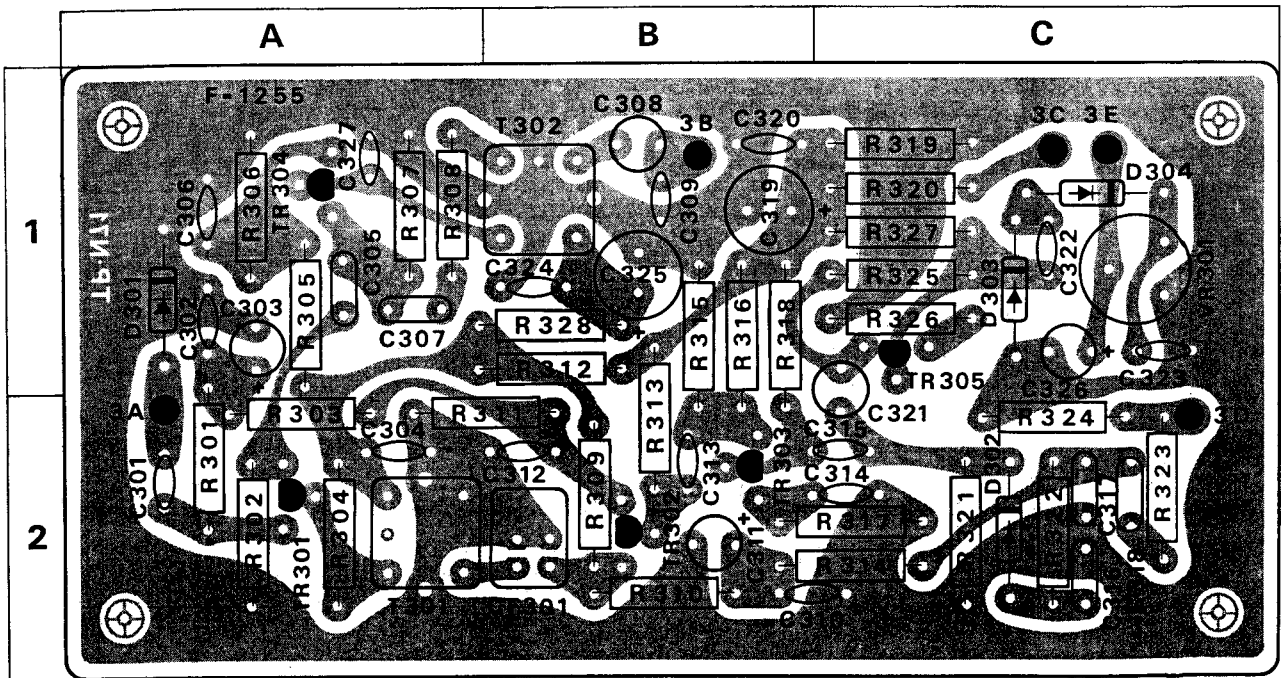

X	Y	Z
C317	0.0047 μ F } $\pm 10\%$ 50 WV Mylar Capacitor	2C
C318		2C
C319		1B
C320	0.04 μ F } $\pm 100\%$ 25 WV Ceramic Capacitor	1B
C321	100 pF } $\pm 5\%$ 50 WV Styrol Capacitor	1, 2C
C322	0.02 μ F } $\pm 100\%$ 25 WV Ceramic Capacitor	1C
C323	0.02 μ F } $\pm 100\%$ 25 WV Ceramic Capacitor	1C
C324	0.04 μ F } $\pm 100\%$ 25 WV Ceramic Capacitor	1B
C325	47 μ F } 16WV } Electrolytic Capacitor	1B
C326	10 μ F } 10WV } Electrolytic Capacitor	1C
C327	47 pF } $\pm 10\%$ 50WV Ceramic Capacitor	1A
C328	0.001 μ F } $\pm 10\%$ 50WV Mylar Capacitor	1A
TR301	2SC460(B, C) (030535,-1)	2A
TR302		2B
TR303		2B
TR304		1A
TR305		1C
D301	1N34A (031040)	1A
D302		2C
D303		1C
CF301	Ceramic Filter (091009)	2B
T301	Matching Coil (423039)	2A
T302	OSC Coil (422020)	1B

X	Y	Z
C501	1 μ F } 50 WV } Electrolytic Capacitor	1A
C502		1A
C503		1A
C504		1A
C505	1000 pF } $\pm 5\%$ 50 WV Styrol Capacitor	1B
C506		1B
C507		1B
C508		1B
C509		1B
C510		1B
C511		1B
C512		1B
C513	0.0033 μ F } $\pm 10\%$ 50 WV Mylar Capacitor	1A
C514	0.04 μ F } $\pm 100\%$ 25 WV Ceramic Capacitor	1B
TR501	2SC458L(G) (030531-1)	1A
TR502		1A
TR503		1B
TR504	2SC458L(C) (030542-1)	1B
L501	Coil (424057)	1B
L502		1B

MPX DIFFERENTIAL AMP <F-1245>

X	Y	Z
R501	2.2k Ω } $\pm 10\%$ $\frac{1}{4}$ W Carbon Resistor	1A
R502		1A
R503		1A
R504		1A
R505		1A
R506		1A
R507		1B
R508		1B
R509		1A
R510		1A
R511		1A, B
R512		1A, B
R513		1B
R514		1B
R515		1B
R516		1B
R517		1B
R518		1B
R519		1A
VR501	10k Ω (B) Separption Adjustment (103513)	1A

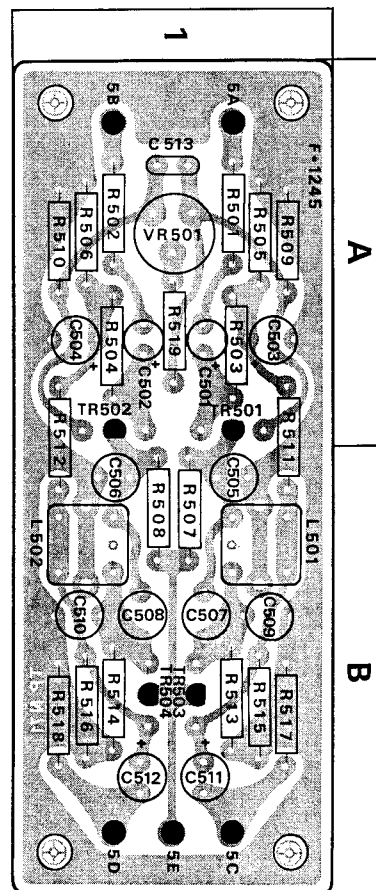

PRINTED CIRCUIT BOARDS AND PARTS LIST

X: Parts No Y: Parts Name Z: Position of Parts

FM IF <F-1262>

X	Y	Z	
R201	1.8kΩ	1 A	
R202	6.8kΩ	1 A	
R203	22kΩ	1 B	
R204	1kΩ	1 A, B	
R205	560Ω	1 B	
R206	6.8kΩ	1 B	
R207	18kΩ	1 B	
R208	1kΩ	2 B	
R209	680Ω	1 B	
R210	12kΩ	1 C	
R211	6.8kΩ	2 C	
R212	1kΩ	1 C	
R213	820Ω	1 C	
R214	100Ω	1 D	
R215	1.2kΩ	1 D	
R216	1.2kΩ	1 D	
R217	12kΩ	1 D	
R218	12kΩ	±10% ¼W Carbon Resistor	
R219	27Ω		1 B
R220	27Ω		1 B
R221	27Ω		1 C
R222	27Ω		1 C
R223	470kΩ		2 A
R224	100kΩ		2 A
R225	560Ω		2 A
R226	68kΩ		1, 2 A
R227	18Ω		2∞
R228	18Ω	2 B	
R229	8.2kΩ	2 B	
R230	22kΩ	2 B, C	
R231	27Ω	2 B, C	
R232	1kΩ	1, 2 C	
R233	100Ω	2 D	
R234	27kΩ	2 C	
R235	27kΩ	2 D	
R236	15kΩ		
VR201	220kΩ(B) Muting Adjustment (103521)	2 C	
VR202	47kΩ(B) Tuning Meter (103517)	2 C	
C201	0.02μF $\begin{matrix} +100\% \\ -0\% \end{matrix}$ 25 WV	1 A	
C202		1, 2 A	
C203		1 A	
C204		1 A	
C205		1 A	
C206		0.02μF $\begin{matrix} +100\% \\ -0\% \end{matrix}$ 25 WV	2 A, B
C207		1 B	
C208		2.2 pF ±0.5pF 50 WV	1 A, 2 B
C209		0.02μF $\begin{matrix} +100\% \\ -0\% \end{matrix}$ 25 WV	2 B
C210		1 C	
C211	1μF 50 WV Electrolytic Capacitor	1, 2 C	
C212	0.02μF $\begin{matrix} +100\% \\ -0\% \end{matrix}$ 25 WV	1 C	
C213	0.02μF $\begin{matrix} +100\% \\ -0\% \end{matrix}$ 25 WV	1 C	
C214	100 pF $\begin{matrix} +100\% \\ -0\% \end{matrix}$ 50 WV	1, 2 D	
C215	220 pF $\begin{matrix} +100\% \\ -0\% \end{matrix}$ 50 WV	1 D	
C216	220 pF	1 D	

X	Y	Z
C217	10μF 10 WV Electrolytic Capacitor	1 D
C218	0.02μF $\begin{matrix} +100\% \\ -0\% \end{matrix}$ 25 WV Ceramic Capacitor	1 A
C219		1 B
C220		1 B
C221		1 C
C222		1 D
C223	100μF 16 WV Electrolytic Capacitor	1, 2 D
C224	0.02μF $\begin{matrix} +100\% \\ -0\% \end{matrix}$ 25 WV Ceramic Capacitor	2 A
C225		2 A
C226		2 A
C227		2 A
C228		2 A, B
C229		2 B
C230		2 B
C231		2 C
C232		2 C
C233		2 D
C234	2 D	
C235	2 D	
C236	2 D	
C237	2 D	
TR201	2SC829(C) (030546-1)	1 B
TR202		1 B
TR203		1 C
TR204		2 C
TR205		2 C
D201	1N60 (031033)	1, 2 A
D202		1, 2 A
D203		1 D
D204		1 D
D205		2 C
D206	DS410 Varistor (031046)	2 D
IC201	LM703L (036004)	1 A
T201	FM IFT (423548)	1 A
T202	FM IFT (423546)	1 B
T203	FM IFT (423546)	1 C
T204	Discri Transformer (423556)	1 C
T205	FM Meter Transformer (423529)	2 C
L201	3.5μH Choke Coil (429001-1)	2 A, B

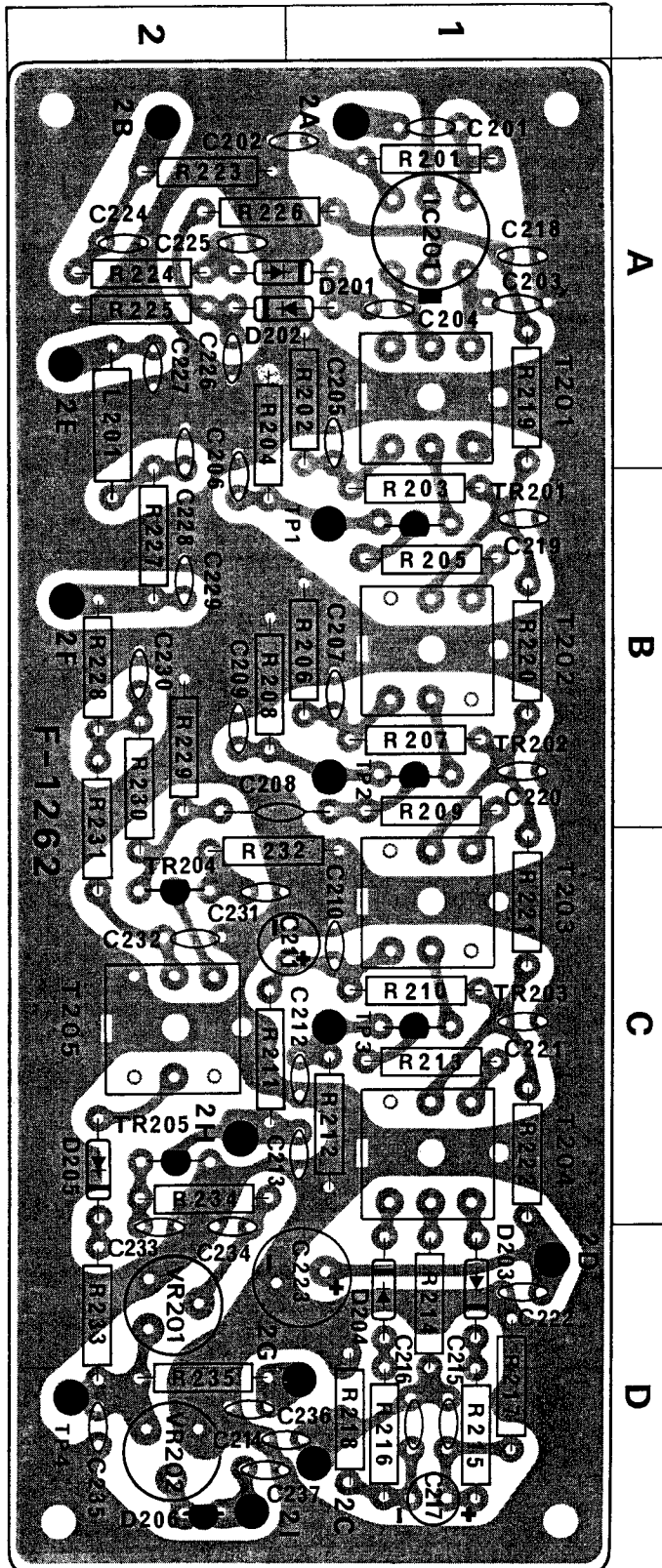

PRINTED CIRCUIT BOARDS AND PARTS LIST ACCESSORIES

X: Parts No. Y: Parts Name Z: Position of Parts

POWER <F-1270>

X	Y	Z	
R001	560Ω	±10% ¼W Carbon Resistor	
R002	680Ω		
R003	390Ω	±10% ½W Solid Resistor	
R004	47Ω	±10% ¼W Carbon Resistor	
C001	330μF	50 WV } 25 WV } 50 WV } 25 WV } 16 WV } 16 WV } 10 WV } Electrolytic Capacitor	
C002	100μF		
C003	33μF		
C004	100μF		
C005	220μF		
C006	100μF		
C007	470μF		
TR001	2SD223(Y)	(030823-1)	1 A, B
D001	10DC(N)	(031068)	1 B
D002	10D-1	(031034)	1 A
ZD001	ZB1-25	(031071)	1 B

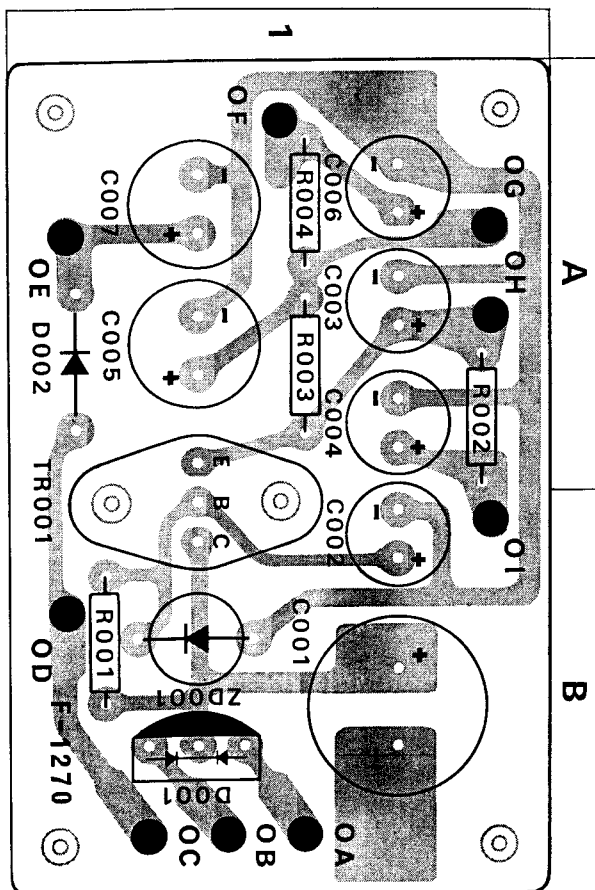

OTHER PARTS

X	Y	Z
R011	1.8kΩ	±10% ¼W Carbon Resistor
R012	680Ω	
R013	68Ω	
R014	1kΩ	
R024	6.8Ω	±10% 1 W Wire Wound Resistor
R246	470Ω	±10% ¼W Carbon Resistor
R438	47kΩ	
R439	10kΩ	
C011	0.0015μF	±10% 50 WV Mylar Capacitor
C012	0.0047μF	600WV Oil Capacitor
C013	0.022μF	
C430	3.3μF	25 WV Electrolytic Capacitor
C521	100Ω	±10% ¼W Carbon Resistor
C522	100Ω	
PL001~006	6.3V 0.25A Pilot Lamp	(040009)
PL007	6V 0.1A Pilot Lamp	(040016)
F001	0.5A FUSE (100~117V)	(043044)
	0.3A FUSE (220~240V)	(043045)
M001	200μA Tuning Meter	(090025)
CO001	AC Outlet	(245001)
PT001	Power Transformer 400-5397	(400066)
T102	FM Antenna Trans 300Ω : 75Ω	(429002-1)
L301	Ferri Inductor 150μH	(490008)
L302	Bar Antenna	(420031)
S1	Antenna Switch	(111004)
S2(a~e)	Selector Switch	(110216)
S3	Noise Canceler Switch	(117017)
S4	Power Switch	(113016)
S5	Muting Switch	(117017)

Accessories List

1.	FM ANTENNA	1
2.	AM ANTENNA	1
3.	OPERATING SHEET	1
4.	OPERATING INSTRUCTIONS AND SERVICE MANUAL	1
5.	CONNECTION CORD WITH PIN PLUGS	2
6.	BUTTERFLY BOLTS	2
7.	WASHERS	2
8.	POLISHING CLOTH	1

OTHER PARTS AND THEIR POSITION ON CHASSIS

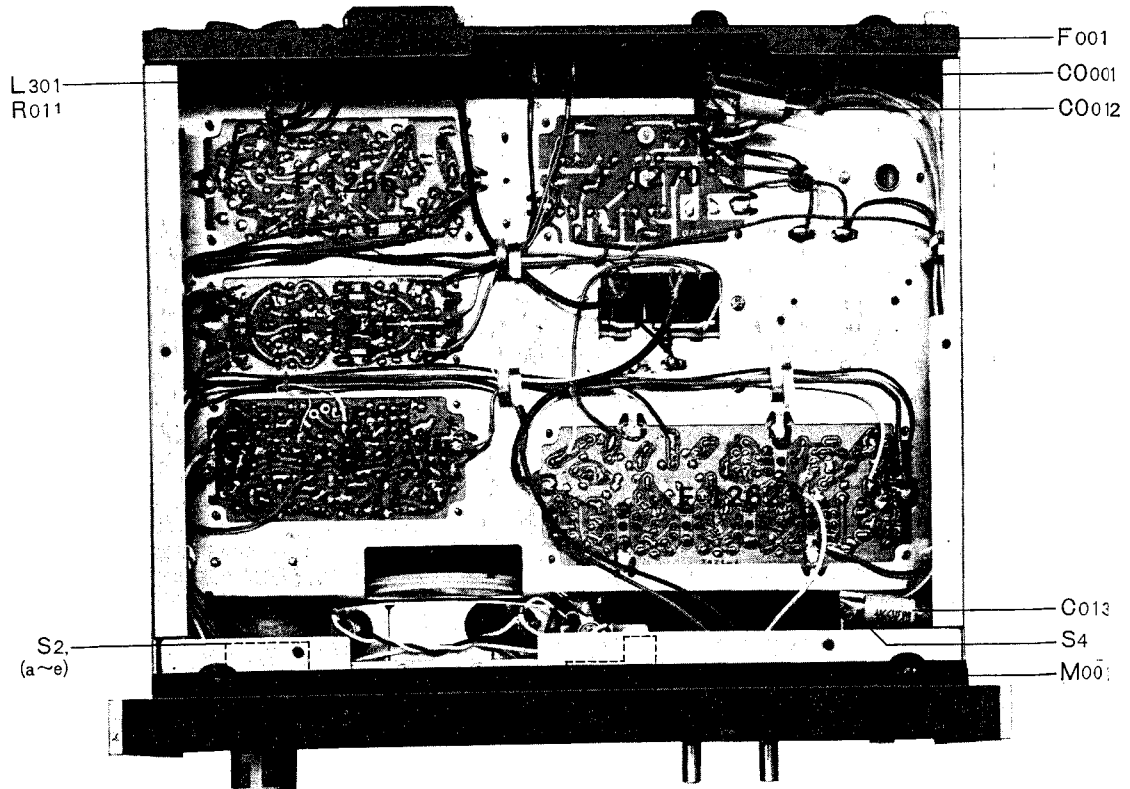
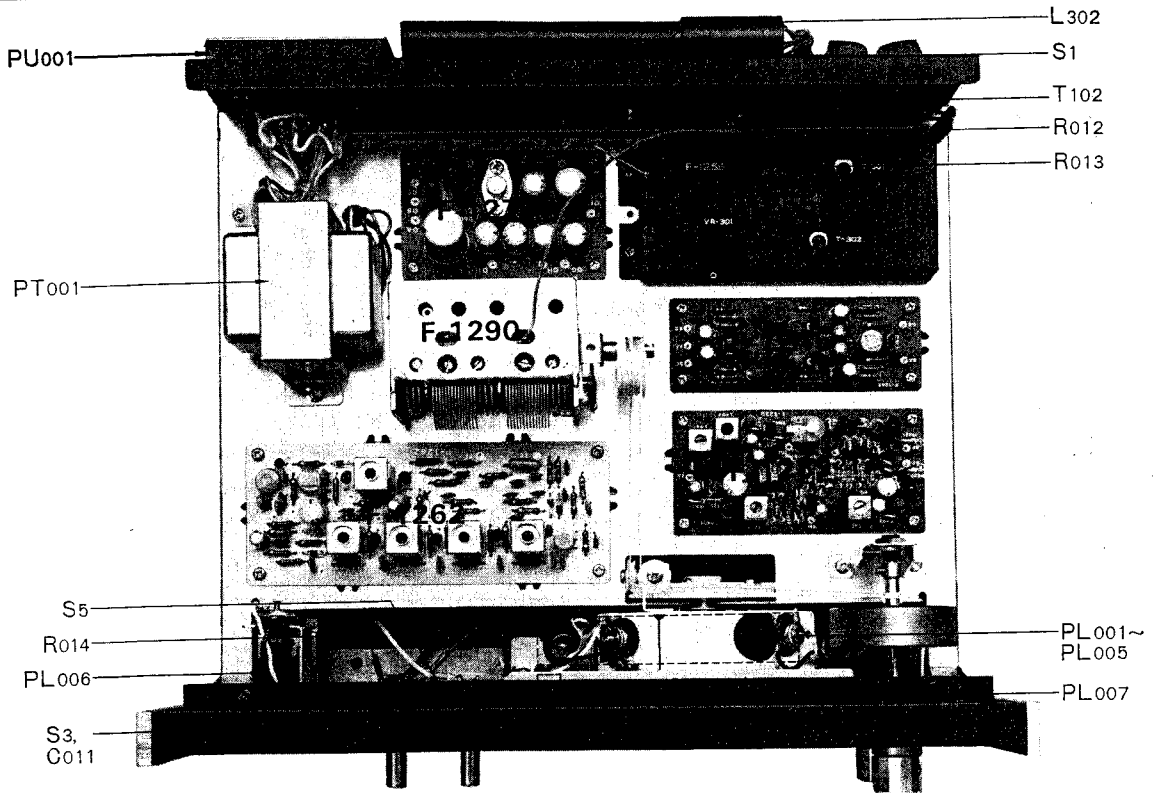

GENERAL TROUBLESHOOTING CHART

In some instances, the amplifier which is operating satisfactorily develops hum or noise as listed on this page. In this case, eliminate the trouble source as indicated in the column under WHAT TO DO.

If you are confronted with a trouble not covered here or if you have any questions concerning the operation and maintenance of this amplifier, please contact our Customer Service Department.

If your AM and/or FM stereo listening isn't all you'd expected, it is in many cases that the tuner is not at fault. The trouble may attributed to the following:

1. Incorrect component connection or loose terminal contact;

2. Incorrect or improper operation of tuner and/or other components;
3. Improper location of components;
4. Other component or components defective.

Other probable causes are listed below:

PROGRAM	SYMPTOM	PROBABLE CAUSE	WHAT TO DO
AM, FM mono or FM stereo	A. Constant or intermittent noise heard at times or in a certain area	<ul style="list-style-type: none"> * Discharge or oscillation caused by electrical appliances, such as fluorescent lamp, TV set, D.C. motor, rectifier and oscillator * Natural phenomena, such as atmospherics, statics, strays and thunderbolt * Insufficient antenna input due to thick reinforced concrete wall of a building or long distance from the station * Wave interference from other electrical appliances 	<ul style="list-style-type: none"> * Attach a noise limiter to the electrical appliance that causes the noise, or attach it to the power source of the amplifier. * Install an outdoor antenna and ground the amplifier to raise the signal-to-noise ratio. * Reverse the power cord plug-receptacle connections. * If the noise occurs at a certain frequency, attach a wave trap to the ANT. input. * Keep the set in proper distance from other electrical appliances.
	B. The needle of the tuning meter does not move well.	The movement of the needle is one thing, the sensitivity of the amplifier is another.	Turn the set for maximum signal strength.
	C. The zero point of the meter diverges much.	Regional difference in field intensity	The unit is not at fault.
AM	A. Noise heard at a particular time of a day, in a certain area or over part of dial	This results from the nature of AM broadcast.	<ul style="list-style-type: none"> * Install the antenna for maximum antenna efficiency. * In some cases, the noise can be eliminated by grounding the amplifier or reversing the power cord plug-receptacle connections.
	B. High-frequency noise	<ul style="list-style-type: none"> * Adjacent-channel interference or beat interference * TV set too close to the audio system 	<ul style="list-style-type: none"> * Although such noise cannot be eliminated it is advisable to switch on the noise filter of the amplifier. * Keep the TV set in proper distance from the audio system.

PROGRAM	SYMPTOM	PROBABLE CAUSE	WHAT TO DO
FM	A. Noisy	* Poor noise limiter effect or to low S/N ratio due to insufficient antenna input	* Install the antenna (supplied) for maximum signal strength. * If this does not prove effective, use an outdoor antenna designed exclusively for FM. When you use a TV antenna for both TV and FM with the help of a divider, make sure the TV reception is not affected. * Excessive long antenna may rather cause a noise.
	Note: FM reception is affected considerably by the conditions of transmission by stations: power and antenna efficiency. As a result, you may receive one station quite well while having difficulty in receiving another station.		
	B. A series of pops	* Ignition noise caused by the starting of an automobile engine	* Install the antenna and its lead-in wire in proper distance from the road or raise the antenna input as described above.
	C. Distortion or no sound during the reception	* Drift of tuning resulted from the nature of FM	* Retune the signal with the tuning knob.
	D. Tuning noise between stations	This noise results from the nature of the FM reception. As the station signal becomes weak, the noise limiter effect is also decreased. The amplification of the limiter, in turn, is enlarged and thus a big noise is generated.	* Turn the MUTING switch on.
FM stereo	A. Noise heard during FM-MPX reception while not heard during FM mono reception	* The service area of the FM-MPX broadcast is only half as much as that of the FM mono broadcast.	* Install the antenna for maximum antenna input. * Switch on the NOISE CANCELER.
	B. Clearness of channel separation is decreased during the reception.	* Excess heat	* Circulation of air is important to the amplifier. Make sure that air can flow underneath.
	C. The stereo indicator goes on and off.	* Interference	* The indicator is not at fault. * Readjust VR ₄₀₁ .
	D. The stereo indicator goes on and off even though a stereo station is not received.	* Interference	* The indicator is not at fault. * Readjust VR ₄₀₁ .
	E. The BALANCE control of the amplifier used is not at the midpoint when equal sound comes from left and right channels	* The BALANCE control should not be always set to the midpoint	* Set the control to the position where equal sound comes from both channels * Check for unequal program loudness

* Design and specifications subject to change without notice for improvements.