

SERVICE MANUAL stereo turntables

PS17

PS47

PS57

PS67

PS76

PS87



 **SCOTT**®
The Name to listen to.

H. H. SCOTT, INC., 20 Commerce Way, Woburn, Mass. 01801, Tel. 617 933-8800

1. Notice:

The following safety precautions must be followed to assure continued reliability and safety against fire and shock hazard:

- 1) Replacement parts used during servicing of this appliance must have identical characteristics as those offered and recommended by H. H. Scott, Inc.
- 2) Satisfactory and approved service procedures dictate that ALL PARTS, no matter how apparently unimportant, be replaced exactly as in the original design.

EXAMPLES:

- a) Braided glass tubing over resistors.
 - b) Heatsinks on transistors.
 - c) Ceramic tube spacers.
 - d) All mechanical parts, i.e. covers, brackets, etc.
- 3) A dielectric test is to be performed on each appliance following the re-assembly and before returning the unit to the customer.
 - 4) The dielectric test, to be performed on H. H. Scott, Inc. electronic components serviced in the U. S. and Canada for use in these countries, shall consist of not less than the following:*
- 1) A dielectric tester designed to supply not less than 1100 volts at 60 Hz and employing leakage current indicator/s is to be used.
 - 2) The tester is to be connected per the instructions enclosed with the instrument, or as follows:
 - a) The tester is connected to the power line receptacle, and the power switch is turned on.
 - b) Sufficient time is allowed for the tester supply to stabilize and then the output voltage is adjusted for 1080 volts.
 - c) Leads of the tester, usually marked GND and HV, are connected between chassis ground and both blades of the male plug of the power cord.
 - d) Switch tester to "test" and observe leakage indicator.

LEAKAGE CURRENT MUST NOT EXCEED 0.5 mA.

* Dielectric tests made by service personnel in countries other than United States and Canada must use test equipment and procedures specified by the safety agency serving that country.

CAUTION: Remove head shell from tone arm before applying dielectric test.

2. Specifications:

	PS-17	PS-47	PS-57	PS-67/87	PS-76
Speed control %	None	± 3	± 3	± 3	± 3
Wow/flutter (WRMS)	0.07%	0.05%	0.05%	0.03%	0.04%
S/N ratio	52 dB	55 dB	55 dB	60 dB	60 dB
Tone arm length	213mm	210mm	210mm	210mm	220mm
Stylus pressure range	1.5-4 grams	1-4 grams	1-3 grams	1-3 grams	1-3 grams
Anti skating range	0-4 grams	0-4 grams	0-4 grams	0-4 grams	0-3 grams
Power consumption	10 Watts	2 Watts	2 Watts	11 Watts	4.5 Watts
Drive system	Belt	Belt	Belt	Direct	Direct

Recommended Equipment:

1. AC Vacuum tube voltmeter.
2. DC Millivolt meter or DMM.
3. Oscilloscope.
4. Volt-Ohm meter.
5. Wow/flutter meter.
6. Broadcast test record. (CBS labs STR 151 or equivalent).
7. Supply of light machine oil, (not motor oil).
8. Tube of grease. (LUBRIPLATE or equivalent).
9. Suitable hand tools, cables, variable power line transformer.
10. Suitable line voltage and current monitoring meters.

----- NOTICE -----

Scott Electronic Components are manufactured with a serial number code to identify the manufacturing plant and the year of manufacture. The following information will explain the code.

- 1) The first six digits are the unit serial number.
- 2) The first of the two letter suffix is the manufacturing plant code.
- 3) The second letter identifies the year of manufacture.

A-1975 B-1976 C-1977 D-1978 etc.

H. H. Scott, Inc. reserves the right to make changes in model design and technology without giving prior notice.

3. General Information

This manual has been prepared to cover the various aspects of servicing six different H. H. Scott, Inc. turntables. Since the cartridge installation and tone arm balance procedures are included in the operator's manual supplied with each appliance purchased, only a general procedure has been included here. Cartridges are not normally supplied by H. H. Scott, Inc.

All models, except the Model No. PS-17, use a form of electronically controlled DC or AC motor, that provides accurate speed and pitch control, as well as simple electronic switching between the two speeds, 33 1/3 and 45 rpm.

The model Nos. PS-17, PS-47 and PS-57 are belt driven models, all others are direct drive.

All models are designed for playing a single 12 inch (30.48cm) diameter record, and may also be used to play records of smaller diameter. The tone arm will return to rest at the end of each play.

4. Maintenance

CAUTION: Before proceeding with any maintenance or service, disconnect power supply cord and provide stylus protection.

The tone arm assemblies, used in all models, are essentially maintenance free and require no routine service. The lateral bearing consists of a double race, precision ball assembly, adjusted at the factory for zero end play. The vertical bearings are precision ball and cone, also pre-adjusted. Adjustment or lubrication is not recommended.

Maintenance is not normally required on the models PS-67, PS-76 and PS-87 direct drive models, except for routine pickup stylus inspection and possible replacement.

Routine maintenance of the models PS-17, PS-47 and PS-57 is usually limited to drive belt and stylus inspection and possible replacement.

4.1 Lubrication:

Friction points in these turntables are lubricated with high quality, extended life lubricants, which will rarely need replacement. When the need is apparent, it will be necessary to remove the bottom cover, as well as the turntable and turntable mat.

Motors are to be re-lubricated with a suitable light machine oil. Other friction points, such as turntable spindle bearings, pivot points and cams, are to be re-lubricated with high quality white colored grease. A suitable type is sold in North America under the brand name LUBRIPLATE.

NOTE: It is highly advisable to remove all old lubricant before adding the new. If this is not done, it is possible that the old lubricant will contaminate and cause premature failure of the new lubricant.

5. Service Adjustments (see also troubleshooting guide)

5.1 Turntable Speed:

Electronic control models may require service of the control circuits. These can be treated in much the same way as a solid state audio amplifier.

5.2 Pickup Tracking:

Should there be a complaint regarding pickup tracking problems, check to determine that the cartridge is correctly mounted and that the stylus is clean and free of any accumulation of dust.

Also check for proper ANTI SKATING adjustment. (refer to cartridge manufacturer's specification or as noted in 5.10 of this manual).

5.3 Pickup Height:

All models, except the PS-76, include the AUTOMATIC RETURN at end of play feature, actuated by levers and cams.

The distance between pickup stylus and top surface of a single record in the arm return mode is typically 5/16 inch (8 mm). Adjustment of this elevation is accomplished by means of cam screws, screw adjustment, or in some models, only by bending a metal tab on the lift arm.

CAUTION: Before attempting any adjustment that requires bending of components, study the exploded view for the particular model, to determine that no parts are missing or damaged.

5.4 Pickup Lowering Position:

The models PS-57 and PS-87 are fully automatic types with mechanism to start and lower the pickup stylus onto the lead-in groove of any standard record. These models are set at the factory for proper pickup lowering, automatic return and shut-off.

Should improper operation develop, it will be an indication that the tone arm has been forced during a cycle, or that the tone arm lever "set screws" have been loosened. Usually, proper adjustment can be made quite simply by loosening the two set screws, (identified as "73-4" in exploded view) re-adjusting the tone arm lowering position on a record, and then tightening the two screws.

Fine adjustment is done with adjusting screw "73-3". Minor adjustment can be made with this screw only.

5.5 Tone Arm Return, Cut/Reject Control:

All models, except PS-76, are equipped with an automatic arm return mechanism, ganged with a control button marked "CUT" or "REJECT". These features allow minimum operator attention and permit record interruption and motor shut-off at any time. The power is shut off when the tone arm is returned to the REST position.

As in item 5.4, proper adjustment of these controls has been set at the factory. Re-adjustment procedures will follow as in item 5.4.

5.6 Single/Repeat:

The Model Nos. PS-57 and PS-87 include a feature, which permits the operator to select whether to play the record through once and have the player shut down, or to continue with repeat playing of the record until intentionally interrupted.

Since operation of this control moves only levers of fixed size and shape, failure will usually be caused by binding or damaged parts. To correct, clean and re-lubricate or replace parts.

5.7 Record Size Selector:

The fully automatic models include a lever marked SIZE SELECTOR with three positions, 17, 25 and 30. These are the approximate cm equivalent to 7, 10 and 12 inch records.

This simple system of levers and cams will require minimum maintenance and little, if any, adjustment.

5.8 Anti Skating:

An anti skating mechanism is included as an integral part of the tone arm base in all models. This device works on the principle of spring loading the tone arm to compensate for forces applied to the stylus by the rotating disc.

Service of this mechanism is limited to replacement of parts only with factory supplied original equipment types, or to replacement of the complete tone arm assembly. Lubricant is not used in servicing the anti skating mechanism.

FOR PROPER SETTING OF THE ANTI SKATING CONTROL, REFER TO THE CARTRIDGE MANUFACTURER'S SPECIFICATIONS.

These specifications supersede the anti skating adjustment outlined in the operator's manual, or in item 5.10, No. 6 of this manual.

5.9 Cartridge Installation:

1. A cartridge is not generally supplied as part of these turntables, so that the customer has complete choice of cartridge brand and type.
2. Suitable cartridges are any standard 12.7mm/1/2" type (ceramic or preferably magnetic) with a Tracking Force of 1.5 to 3.0 grams.
3. Read instructions supplied with cartridge thoroughly before proceeding.
4. Refer to Fig. 1 (please note that mounting screws, washers and nuts are supplied with head shell for mounting the cartridge).
5. Unpack the cartridge and carefully remove stylus guard (if so equipped) and stylus. Carefully place stylus and guard in a safe location.
6. Using tweezers or long nose pliers, carefully connect wires following the color code as shown in figure 1.
7. Using screws, washers and nuts (supplied), loosely install cartridge to the head shell as shown in Fig. 1. (a small flat screwdriver is required). Do not fully tighten screws. Replace stylus in cartridge.
8. Install the head shell onto the tone arm upside down (with stylus tip upward) and rotate lock nut clockwise until head shell is tightly installed.

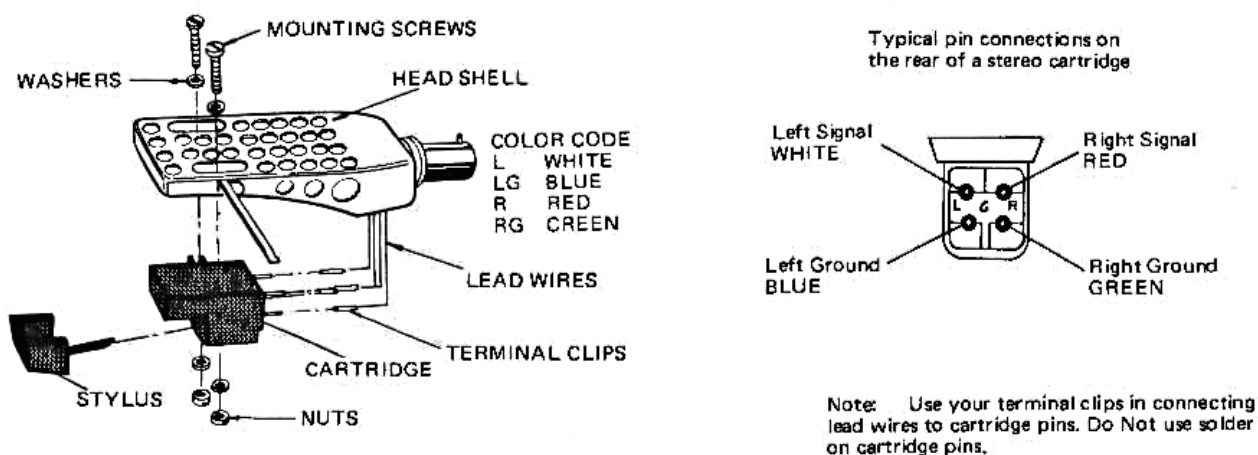

Fig. 1.

9. Adjust cartridge in head shell by sliding cartridge back and forth until the stylus tip is positioned 52mm (2 1/16 inches) \pm 1.6mm (1/16 inch) from the small rubber ring at the connecting point of head shell and tone arm. Make certain that cartridge is square in the head shell.
10. Carefully remove head shell without changing cartridge position and tighten the mounting screws.
11. Re-install the head shell on the tone arm in its normal position.

5.10 Stylus Pressure Adjustment:

For proper performance of your phono cartridge, the stylus pressure must be adjusted to the tracking force recommended by the cartridge manufacturer. Proceed as follows:

1. Unlock tone arm hook, also remove cartridge stylus cover.
2. Start motor. Ensure that the cue lever is in down position so that the arm can move freely. Set anti-skate control to "0".

NOTE: If the arm lifter is sticky in operation at the beginning, lightly push down on the arm lifter with your fingers.

3. Zero balance the arm by rotating the counter weight until the arm is laterally balanced.
4. Now adjust only the counter weight dial ring so that the dial position "0" lines up with the RED line marked on the tone arm, being careful not to rotate the counter weight.
5. Finally, rotate the counter weight until the dial indicates the manufacturer's specified stylus pressure.
6. Normally, the anti-skate adjustment is set to the same number as the stylus tracking force. The anti-skate setting for elliptical or Shibata styli should be set to the cartridge manufacturer's specification.

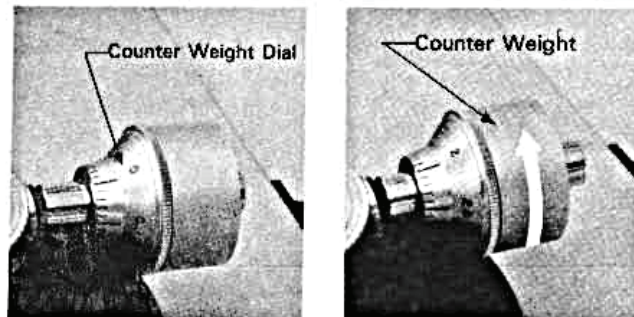

Fig. 2

The electronic motor control circuit, of the Model Nos. PS-47, PS-57, PS-67 and PS-87, consists of the three basic components described below.

1. Power Supply:

The power supply, with isolation transformer, fuses, neon strobe lamp and power switch, provides a rectified and filtered DC supply for motor operation and electronic control in the models PS-47, PS-57 and PS-76.

The DC supply components, for models PS-67 and PS-87, are mounted on the ELECTRONIC CONTROL printed circuit board.

2. The motor, in addition to providing power to drive the turntable, has a small alternator built in to create a sine wave used with the electronic circuit for speed control. (except PS-76)

3. Electronic Control: (PS-47 - PS-57)

The electronic control circuit, through the use of X1 and X2 as a DC regulator, provides 7.25V DC.

Transistors, X3 and X4, connected to the AC output of the motor, form a square wave generator. The square wave is coupled to the base of X5, and applied to the base of X6 as a saw tooth wave form. The differential pair, formed by X6 and X7, are the heart of the control circuit, where a DC reference voltage, selected by the speed control switch and controlled by fixed divider resistors (R16 & R15) and variable resistors (VR1 & VR3), apply an adjustable voltage to the base of X7. X7 is used to control the current through the differential pair, thereby setting the operating bias of X8, and in turn, through collector divider R20 and R22, the operating current of X9.

Electronic motor speed adjustment is made using speed control potentiometers, VR3 or VR4, to set the DC operating point of X7 and X6. A saw tooth wave form, of suitable shape and amplitude, is developed by components C1, C2, R9, R10, R11 and transistor X5. The positive peak of the saw tooth causes X6 to conduct, forming a pulse on the base of X8 and X9 at the rate of approx. 300 P/S (45 rpm). The duration of this pulse, momentarily and repeatedly, increases current in the motor to maintain motor speed. If motor speed is reduced by external load, pulse duration (formed by R11 and C2) will increase to draw more current through X6, and thus through X8, X9 and the motor winding, to compensate for the increased external load.

4. Electronic Control: (PS-67 - PS-87)

Speed control of AC motors, used in the PS-67 and PS-87, uses a somewhat more complex pulse forming circuit. Differential amplifier transistors, X7 and X8, act to control the pulse duration, and to change the direct current through X9, X10, X11 and X1. X1, in turn, varies the current through bridge rectifier, SIRBA 40, to control the AC through the drive motor in much the same way the DC motors are controlled.

5. Electronic Control: (PS-76)

Motor drive circuitry in the PS-76 uses TR1 as a 50 kHz oscillator, with output connected to coils, L1, L2 and L3, in the motor. Pick-up coils, L4, L5 and L6, connected to rectifiers, D8, D9 and D10, and capacitors, C8, C9 and C10, apply a pulsating DC voltage to transistors, TR6, TR7 and TR8. Pulsations are caused by the rotating iron poles attached to the rotor shaft. These poles are accurately aligned to the poles in the ferrite ring magnet to provide the necessary pulse at the proper time.

When pulsations are applied to the motor windings, the coils, connected to D11, D12 and D13, provide a voltage across C7. Proportional to the motor R.P.M., this voltage is filtered and applied to the base of TR3. If the voltage applied from this source, exceeds the voltage pre-set by the motor speed control potentiometers, current in the MOTOR DRIVE BLOCK will be reduced, thus slowing the motor.

As in other models described in this manual, the motor speed is manually controlled by a referenced voltage. In the PS-76, TR2 serves as the regulator transistor, referenced by zener diode, ZD1, and diodes D3, D4, D5 and D6. This voltage, applied through the speed control potentiometers and their associated trim pots, establishes a fixed bias on TR3 and the remainder of the MOTOR DRIVE BLOCK.

It should be noted that the turntable diecasting is an integral part of the motor system, acting as a flywheel to "smooth out" the effect of electrical pulses applied to the motor.

TROUBLESHOOTING GUIDE

FAULT	CAUSE	CORRECTION
<p>Turntable Speed</p> <p>a) Will not start: Nos. 1, 2, 3, 4, 6, 8, 9 and 10.</p> <p>b) Turns slow: Nos. 2, 4, 5, 7, 8, 11 and 13.</p> <p>c) Turns fast: Nos. 8, 11 and 13.</p> <p>d) Speed changes without apparent cause: Nos. 2, 4, 5, 8, 12 and 13.</p>	1) No voltage to turntable	Check power supply outlet. Check power cord and power fuse in electronic controlled models.
	2) Motor bearings binding or frozen.	Check assembly for mechanical damage. Repair, lubricate or replace as indicated.
	3) Fuse open in electronic models.	Replace fuse, repair electronics as required.
	4) Drive belt defective or missing.	Determine cause of defect and correct. Replace belt.
	5) Oil on belt.	Determine cause of oil, correct and replace belt.
	6) Motor winding open.	Winding resistance of DC motors, approx. 15 ohms with rotor stalled. AC motors measure 400 ohms between black and white leads; 640 ohms between black and red leads. Replace motor as required.
	7) Motor frequency generator winding open.	Winding resistance of DC motor frequency generator winding is 80 ohms (PS 47 & PS 57). Winding resistance of AC motor frequency generator winding is 400 ohms (PS 67 & PS 87). Since the control circuitry is an integral part of the PS 76 motor, it is replaced as a complete module.
	8) Circuit defect in electronic control models.	Troubleshoot and repair. Refer to circuit description.
	9) Defective switch.	Replace switch.
	10) Wrong supply voltage.	Check input supply rating on turntable. Correct supply voltage condition.
	11) Speed control "trim pots" improperly adjusted.	Check power supply line frequency. Set speed control knobs to center of range. Set turntable into operation. Adjust trim pots VR1 (33 1/3) and VR2 (45) so that proper marks on turntable appear to stand still. Switch 33/45 lever to the appropriate position.
	12) Two or more records on turntable, one record warped.	Remove warped record.
	13) Belt improperly positioned on motor pulley. (PS 17)	Adjust speed control lever.

TROUBLESHOOTING GUIDE

FAULT	CAUSE	CORRECTION
Pickup Tracking a) Will not follow record groove: Nos. 1 thru 11. b) Excessive audio distortion: Nos. 2, 3, 4, 5, 9 and 10. c) Record jumps occasional groove: Nos. 1 thru 11.	1) Cartridge improperly mounted.	Refer to cartridge mounting section in OPERATORS manual.
	2) Stylus dirty.	Clean dirt from stylus, inspect stylus with microscope to determine if suitable for continued service.
	3) Stylus damaged	Replace stylus.
	4) Anti-skating improperly adjusted.	Correct the anti-skating adjustment to cartridge manufacturer's specifications.
	5) Turntable not on level surface.	Turntable must be installed on level surface for proper operation.
	6) Tone arm binding.	Inspect arm mechanism, repair or replace as required.
	7) Cueing control or lift arm not fully released.	Determine reason, make necessary adjustments or lubricate as required.
	8) Arm return mechanism binding.	Clean and adjust mechanism as required.
	9) Improper stylus pressure.	Set stylus pressure per cartridge manufacturer's specification.
	10) Defective record.	Discard record.
	11) Too many records on turntable.	Turntable is designed to play one record.

TROUBLESHOOTING GUIDE

FAULT	CAUSE	CORRECTION
Pickup Height a) Arm does not lift off record on return cycle: Nos. 1, 2 and 3. b) Arm lifter (cueing control) does not lift arm: Nos. 1, 2 and 3. c) Insufficient or excessive lift: Nos. 1, 2 and 3.	1) Worn or damaged cams or levers.	Inspect for worn or damaged parts. Replace and lubricate as required.
	2) Bent or damaged components.	Repair or replace.
	3) Improper lift adjustment.	Inspect for damaged or missing parts. Repair, replace and relubricate as necessary.
Pickup Lowering Position Arm does not lower stylus on lead-in groove: (PS 57 & PS 87 only)	1) Arm lowering mechanism damaged or binding.	Inspect to determine cause of damage, replace parts as required. Relubricate.
	2) Arm lowering mechanism adjustments moved.	Re-adjust as outlined in 5.4.
	3) Arm movement mechanism damaged or binding.	Inspect to determine cause. Replace parts as required. Relubricate.
Tone Arm Return Cut/Reject Control (all models except PS 76)	a) Arm will not return to REST position at end of record.	CAUSE AND CORRECTION OF FAILURE OF THIS MODE ARE IDENTICAL TO THOSE FOR PICKUP LOWERING POSITION.
	b) Arm returns to REST before end of record.	

PARTS LIST

DRAWING NO.	DESCRIPTION	PART NO.	REMARKS
1	Hinge Plate	895231	All
2	Screw, FM + 4 x 8		All
3	Dust cover	851097-4	All
4	Rubber mat	871222	All
5	Turntable platter	620011	PS-17
5	Turntable platter	620021-1	PS-47/PS-57
5	Turntable platter	620021	PS-67/PS-87
6	45 rpm adaptor	890876	All
7	Screw, BT + 3 x 16		All
8	Spring washer, SW-3		All
9	Flat washer, FW 3.2 x 13 x 0.8t		PS-17/PS-47
9	Flat washer, FW 3.2 x 13 x 1t		PS-57
9	Flat washer, FW 3.2 x 10 x 1t		PS-67/PS-87
10	45 rpm adaptor spindle	890097	All
11	Drive belt	700515	PS-17/PS-47/PS-57
12	Speed change push button	893476	PS-17
12	Pitch control knob	895730	PS-47/PS-57
12	Pitch control knob	895738	PS-67/PS-87
13	Click spring	893180	PS-17
13	Button collar	895728	PS-47/57/67/87
14	Speed change cam	893477	PS-17
14	Speed change lever	895727	PS-47/57/67/87
15	Speed change cover	895772	PS-17
15	Neon lamp housing	895725	PS-47/57/67/87
16	CS stopper		PS-17
16	Potentiometer base	895726	PS-47/57/67/87
17	Flat washer, FW 3.2 x 8 x 0.5t		PS-17
17	Potentiometer	703062	PS-47/57/67/87
18	Wooden base	846422	PS-17
18	Wooden base	846423	PS-47
18	Wooden base	846552	PS-57
18	Wooden base	846421	PS-67/PS-87
19	Screw, FM + 3 x 8		PS-17/67/87
19	Screw, FM + 2.6 x 12		PS-47/PS-57
20	Eccentric pin	893040	PS-17
20	Spring washer, SW 2.6		PS-47/PS-57
20	Spacer	E-832380-2	PS-67/PS-87
21	Screw, BT + 3 x 8		All
22	Speed change base assy	893046	PS-17
22	Pipe	E-234791	PS-47/PS-57
22	Screw, BT + 3 x 20		PS-67/PS-87
23	Speed changer arm	870402	PS-17
23	Rotary switch	871224	PS-47/57/67/87
24	E-washer, E-3		All
25	Fibre washer, 3.2 x 10 x 0.8t		PS-17
25	Fibre washer, 3 x 10 x 1t		PS-47/PS-57
25	Connector	895382	PS-67/PS-87
26	Lock nut, FLN -3		All
27	Badge, Scott logo	895820	All
28	E-washer, E-3.2		PS-17/PS-47
28	Mini-connector assy	895384	PS-67/PS-87
29	Kick lever	890218	PS-17/PS-47
29	Connector housing		PS-67/PS-87
30	Return spring	890259	PS-17/PS-47
30	Wire fastener		PS-57/67/87

PARTS LIST

DRAWING NO.	DESCRIPTION	PART NO.	REMARKS
31	Turntable platter spindle	70125	PS-17
31	Turntable platter spindle	895047	PS-47
31	Turntable platter spindle	891003	PS-57
31	Terminal plate	895521	PS-67/PS-87
32	Turntable bearing assy	700514-1	PS-17
32	Turntable bearing assy	895092	PS-47
32	Turntable bearing assy	896181	PS-57
32	Screw, FM + 3 x 6		PS-67/PS-87
33	Stopper	E-271110	PS-17
33	Stopper	894271	PS-47
33	Stopper	891480	PS-57
33	Colored terminal		PS-67/PS-87
34	Mounting board	850848	PS-17
34	Mounting board	850902-1	PS-47
34	Mounting board	851077-1	PS-57/67/87
35	Screw, FMW + 3.1 x 8		PS-17
35	PC support	894023	PS-47/PS-57
35	Circuit board assy	631399	PS-67/PS-87
36	Screw, FM + 4 x 12		PS-17
36	Screw, FMT + 3 x 6		PS-47/57/67/87
37	Motor mounting board	894173	PS-17
37	Motor mounting board	893931	PS-47/PS-57
37	Heat sink	704136	PS-67/PS-87
38	Motor pulley	703740-2	PS-17
38	Grounding wire assy	894509-1	PS-47
38	Motor pulley	894021	PS-57
38	Heat sink angle	895376	PS-67/PS-87
39	Tapping screw, T 2.6 x 2		PS-17
39	Nylon washer, 4.1 x 8 x 1t		PS-47
39	Tapping screw, T 2 x 3		PS-57
39	Screw, FM + 3 x 5		PS-67/PS-87
40	Motor, 1M-S270-15B2	631107	PS-17
40	Motor, DMS-148-61-S-1	631024	PS-47/PS-57
40	Motor	631263	PS-67/PS-87
41	Rubber cushion	702230	PS-17
41	Rubber cushion	E-242020	PS-47/PS-57
41	Grounding wire assy	896059	PS-67/PS-87
42	Washer, FW 4.6 x 13 x 1t		PS-17
42	Washer, FW 4.5 x 13 x 1t		PS-47
42	Grounding wire assy	891965	PS-57/67/87
43	Connector assy	894607-1	PS-17
43	Power source PC board assy	871243	PS-47
43	Fibre washer, FW 3.2 x 7 x 0.5t		PS-67/PS-87
44	Power cord assy	829435-1	All
45	UL tube		All
46	Lug	890755	All
47	6 Pin terminal strip	891849-1	PS-17
47	Strobo lamp	894001-1	PS-47/57/67/87
48	Capacitor	893370	PS-17
48	Power transformer	870645-1	PS-47/PS-57
48	Power transformer	871076	PS-67/PS-87
49	Fibre washer, 5 x 10 x 0.2t		PS-17
49	Fibre washer, 5 x 10 x 0.3t		PS-47
49	Clutch lever	891432	PS-57/67/87

PARTS LIST

DRAWING NO.	DESCRIPTION	PART NO.	REMARKS	
50	Fibre washer, 5 x 10 x 1t	891474	PS-17/PS-47	
50	Clutch lever spring		PS-57/67/87	
51	E-washer, E-4		PS-17/PS-47	
51	Fibre washer, 6 x 13 x 0.5t		PS-57/67/87	
52	Switch lever		PS-17/PS-47	
52	Switch lever assy	891016	PS-57/67/87	
53	Nut, M-3	891947	PS-17/PS-47	
53	Clutch lever coil spring		PS-57/67/87	
54	Screw, FM + 3 x 8		PS-17/47/67/87	
55	Motor cover		PS-17/47/57	
55	Capacitor		892428	PS-67/PS-87
56	Screw, FM 4 x 10	870915-1	All	
57	Bottom cover		PS-17/PS-47	
57	Bottom cover		871348	PS-57
57	Bottom cover		87102801	PS-67/PS-87
58	Rubber foot		895773	PS-17/47/57
58A	Rubber foot	895939	PS-67/PS-87	
58B	Rubber foot	895838-1	PS-67/PS-87	
59	Screw, WM + 3.1 x 13	895215	All	
60	Hinge		PS-17/47/68/87	
60	Hinge		895231	PS-57
61	Cueing rod	892399	PS-17/PS-47	
61	Cueing rod	891680	PS-57/67/87	
62	Function cover	871211	PS-17	
62	Cueing cover	895724	PS-47/57/67/87	
63	Reject button assy	893195-1	PS-17/PS-47	
63	Reject button assy	896033	PS-57/67/87	
64	Button spring	892084	PS-17/PS-47	
64	Button spring	892084-1	PS-57/67/87	
65	Reject lever	892085	PS-17/PS-47	
65	Reject lever	895183	PS-57/PS-87	
66	Cueing cam	895190	All	
67	Cueing cam shaft	894774-1	All	
68	Reject spring	895822	PS-17/PS-47	
68	Reject cam	895178	PS-57/67/87	
69	Tonearm rest	890632-4	PS-17/PS-47	
69	Tonearm rest assy	895322	PS-57/67/87	
69-1	Lock lever	890429-1	PS-57/67/87	
69-2	Lock screw, FMT + 2.6 x 6	890429-1	PS-57/67/87	
70	Screw, FMT - 2.6 x 4		All	
71	Elevation plate		892805	All
72	Tonearm assy	851233-1	PS-17	
72	Tonearm assy	851233	PS-47	
72	Tonearm assy	851313	PS-57	
72	Tonearm assy	851247	PS-67/PS-87	
73	Feed arm assy	890990-1	PS-17/PS-47	
73	Feed base assy	891458-2	PS-57/67/87	
73-1	Feed base	891482	PS-57/67/87	
73-2	Feed arm spring	801553	PS-57/67/87	
73-3	Screw, M3 x 20	891452-1	PS-57/67/87	
73-4	Screw, M3 x 6		PS-57/67/87	
73-5	Friction rubber		PS-57/67/87	

PARTS LIST

DRAWING NO.	DESCRIPTION	PART NO.	REMARKS
74	Elevation spindle	892326	PS-17/PS-47
74	Elevation spindle	892326-8	PS-57/67/87
75	Elevation spring	E-832780-1	All
76	Fibre washer, FW 3.2 x 10 x 0.5t		PS-17
76	Fibre washer, FW 3.2 x 10 x 1t		PS-47
76	Tonearm washer, 12 x 26 x 1.6t		PS-57/PS-87
77	Screw, FM + 3 x 14		All
78	Lock plate	895259	All
79	Rating label	895826	PS-17
79	Rating label	895897	PS-47
79	Rating label	896155	PS-57
79	Rating label	896029	PS-67
79	Rating label	896028	PS-87
80	Serial No. plate	895827	All
81	Plate fixing screw, 3 x 8		All
82	Fibre washer, 3.2 x 8 x 0.5t		All
83	Screw, FM + 3 x 14		All
84	Power cord plate	892624	PS-17/PS-47
84	Power cord plate	893037	PS-57/67/87
85	SR bushing	891568-0	All
86	Clutch plate	894738	PS-17/PS-47
86	Clutch plate	891850	PS-57/67/87
87	Clutch guide	894736	PS-17/PS-47
87	Clutch guide	891005	PS-57/67/87
88	Spring washer	E-813152	PS-17/PS-47
88	Anti-skating spring	892000-1	PS-57/67/87
89	Gear assy	891210	PS-17/PS-47
89	Gear assy	892675	PS-57/67/87
90	Fibre washer, 5 x 10 x 0.5t		PS-17/PS-47
90	Change spring	891485	PS-57/67/87
91	Eccentric pin	817790	PS-17/PS-47
91	Change lever assy	891007	PS-57/67/87
92	GS stud	890620	PS-17/PS-47
92	E-washer, E-2		PS-57/67/87
93	GS eccentric pin	890619	PS-17/PS-47
93	Eccentric pin	891428	PS-57/67/87
94	GS arm	890618	PS-17/PS-47
94	Size select arm assy	891435	PS-57/PS-87
95	GS spring	890628	PS-17/PS-47
95	Size select arm spring	891438	PS-57/PS-87
96	Spring washer	E-813153	PS-17/PS-47
96	Fibre washer, 4.5 x 12 x 0.5t		PS-57/67/87
97	Cueing see-saw	870252	PS-17/PS-47
97	Cueing see-saw	891784	PS-57/67/87
98	See-saw spring	894184	PS-17/PS-47
98	Eccentric pin	891066	PS-57/67/87
99	See-saw angle assy	895824	PS-17/PS-47
99	See-saw holding plate	895242	PS-57/67/87
100	Screw, FMT + 3 x 5		PS-17/PS-47
100	Screw, FM + 3 x 10		PS-57/67/87
101	Lock spring	E-813681	All
102	Screw, FMT + 3 x 8		All
103	Phono output cable	895018	PS-17/PS-47
103	Phono output cable	895016	PS-57/67/87
104	Varnished tube		PS-17/PS-47
104	Bushing	891455	PS-57/67/87

PARTS LIST

DRAWING NO.	DESCRIPTION	PART NO.	REMARKS
105	5 Pin terminal strip	892752	A11
106	Screen plate	821280	A11
107	CS stopper		PS-17/47/57/87
108	Actuating washer	890765	PS-17/PS-47
108	Washer, CSTW-2		PS-57/PS-87
109	Actuating arm assy	890709-3	PS-17/PS-47
109	Actuating arm	870066	PS-57/67/87
110	Actuating base	870038	PS-17/PS-47
110	Revolving base	892475	PS-57/67/87
111	See-saw base assy	890767	PS-17/PS-47
111	Revolving plate assy	891021-1	PS-57/67/87
112	See-saw arm assy	E-830151	PS-17/PS-47
112	Revolving plate	891022-1	PS-57/67/87
113	Eccentric pin	890995	PS-17/PS-47
113	Revolving plate spring	891064	PS-57/67/87
114	Arm spring	892331	PS-17/PS-47
114	Revolving plate spring	891949	PS-57/67/87
115	Screw, FM + 3 x 18		PS-17
115	Reject base assy	895860	PS-47
115	Safety spring	891475	PS-57/PS-87
116	Screw, FM + 3 x 16		A11
117	Switch cover	890335	PS-17/67/87
117	Reject button collar	895943	PS-47
118	Micro switch	890886	PS-17/PS-47
118	Micro switch	870270	PS-57/67/87
119	Switch arm assy	890994	PS-17/PS-47
119	Size select guide assy	891437	PS-57/67/87
120	UL tube		PS-17/PS-47
120	Start lever assy	870157	PS-57/67/87
121	Lug	E-888750	PS-17/PS-47
121	Repeat lever	891444	PS-57/67/87
122	Caution label	893389	PS-17/PS-47
122	Cam spring	893566	PS-57/67/87
123	Warning label	893536	PS-17/PS-47
123	Start lever spring	891443	PS-57/67/87
124	Label	894238	PS-17/PS-47
124	Fibre washer, 3.2 x 10 x 0.5t		PS-67/PS-87
125	Label		PS-17/PS-47
125	Screw, FM + 4 x 12		PS-67/PS-87
126	UL tube		PS-47/57/67/87
127	E-washer, E-6		PS-57/67/87
128	Cut lever spring	890095	PS-57/67/87
129	Collar	896016	PS-57/67/87
130	Steel ball #4		PS-67/PS-87
131	Fibre washer, 3.1 x 6 x 0.5t		PS-57/67/87
132	Start cam-1	895179	PS-57/PS-87
133	Start cam-2	895181	PS-67/PS-87
134	Collar	895169	PS-57/67/87
135	Repeat cam	895174	PS-57/PS-87
136	Size select rod	895184	PS-57/PS-87
137	Rod slide base	895185	PS-57/PS-87
138	Size select spring	893537	PS-57/PS-87
139	Repeat cancellor	893557	PS-57/PS-87
140	E-washer, E-6		PS-57/PS-87

PARTS LIST

DRAWING NO.	DESCRIPTION	PART NO.	REMARKS
141	Switch lever assy	891431	PS-57/PS-87
142	Fibre washer, 4.5 x 12 x 0.8t		PS-57/PS-87
143	Rubber washer	895195	PS-57/PS-87
144	Record size selector	870152	PS-57/PS-87
145	Size select rod	896006	PS-57/PS-87
146	Size select cover	895729	PS-57/PS-87
147	Rubber cap	896015	PS-57/PS-87
148	Head shell stand	892373	PS-67/PS-87
149	Repeat lever assy	896032	PS-57/PS-87
150	E-washer, E-5		PS-57/PS-87
151	Cord clamp	890593	PS-67/PS-87
152	Screw, FM + 3 x 12		PS-57/67/87

NOTES:

- 1) The drawing No. listed corresponds with Nos. on exploded views. The same view is used for both Model Nos. PS-87 and PS-67. The following parts are not used in the PS-67:
 Pts. 65, 76, 94, 95, 107, 108, 115, 127, 132, 135, 136, 137, 138, 139, 140, 143, 144, 145, 146, 147 and 149.

- 2) An exploded view is not included in this manual for the model PS-57. Parts identification for the PS-57 can be made by referring to the drawing nos. and remarks column for usage. Parts used and listed with the PS-47 will be identical to PS-47 parts. Parts used and listed with the PS-67/87 will be identical to parts used in these two models. Refer to both PS-47 and PS-87 exploded views for PS-57 part identification.

- 3) Due to the simplicity in design and construction of the PS-76, an exploded view is not necessary.

PS-76 PARTS LIST

0044065	45 rpm adaptor
0151841	Potentiometer, 1K
2217941	Power transformer
2505175	Power source PC assy
2522311	Motor
2543229	Head shell
2543511	Tone arm
2670061	2 pin phono jack
2727015	Fuse, 0.5A, 250V
2747902	Ground wire
2748022	Phono cord (attached)
2748441	Power cord
2767312	Neon lamp
2787431	Micro switch (SW002)
2787433	Micro switch (SW001)
3910541	Adaptor supporter
3917468	Dust cover
3920212	Control cam
3921152	Arm rest holder
3921211	Arm base
3921221	Lamp case
3921232	Arm rest base
3921346	Tone arm base bracket
3922921	Pitch control knob
3923241	Lever switch knob
3923651	Hinge cover
4386261	Lock plate
4389251	Operation plate
4389423	Spacer
4391217	E-Ring, #4
4394281	Hinge
4513311	Ground screw
4567411	Screw, 3 x 6
4567418	Screw, 3 x 25
4567454	Screw, 3 x 12
4569972	Arm lifter
4683202	Transformer bushing
4682621	Dust cover bushing
4683493	Feet
4683512	Rubber cushion for pickup
4683671	Rubber bushing
4684171	Turntable mat
4770254	Nut, #3 w/washer
4784823	Turntable
4795201	Bottom cover
9303058	Cabinet assy

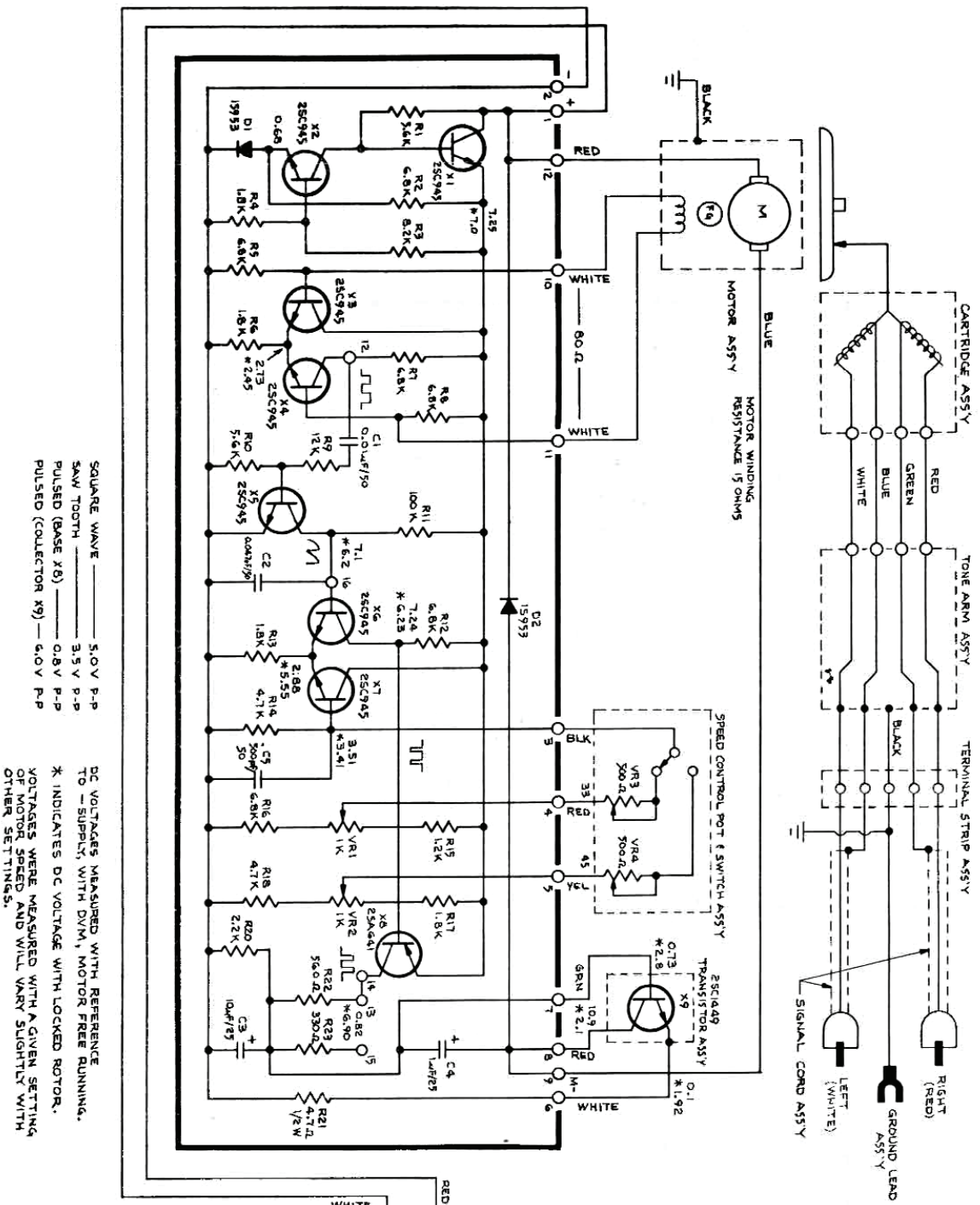

SQUARE WAVE ——— 5.0V P-P
 5mV TOOTH ——— 3.5V P-P
 PULSED (BASE X8) ——— 0.8V P-P
 PULSED (COLLECTOR X9) — 6.0V P-P

DC VOLTAGES MEASURED WITH REFERENCE TO - SUPPLY, WITH MOTOR, FREE RUNNING.
 * INDICATES DC VOLTAGE WITH LOCKED ROTOR.
 VOLTAGES WERE MEASURED WITH A GIVEN SETTING OF MOTOR SPEED AND WILL VARY SLIGHTLY WITH OTHER SETTINGS.

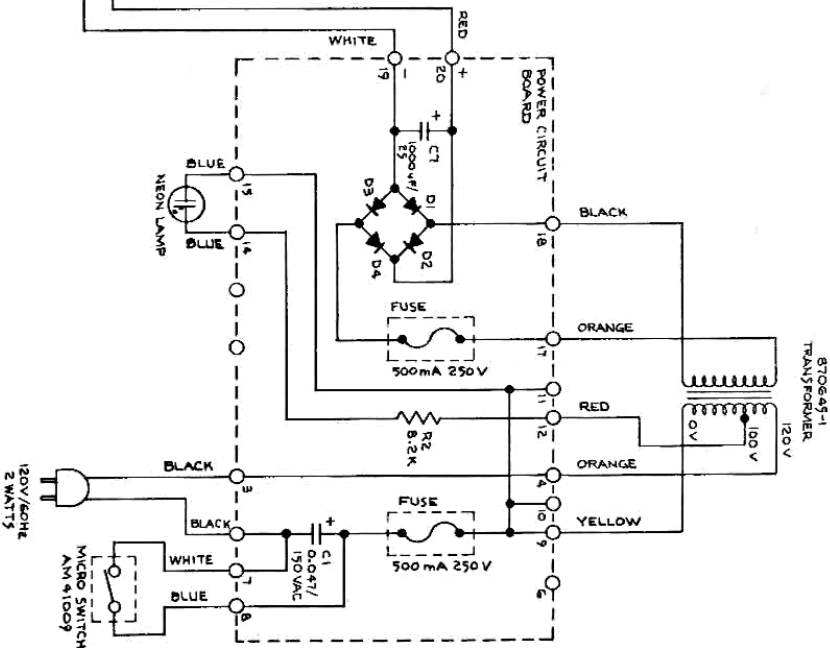

**SCHEMATIC DIAGRAM
PS 76 MOTOR ASSY.**

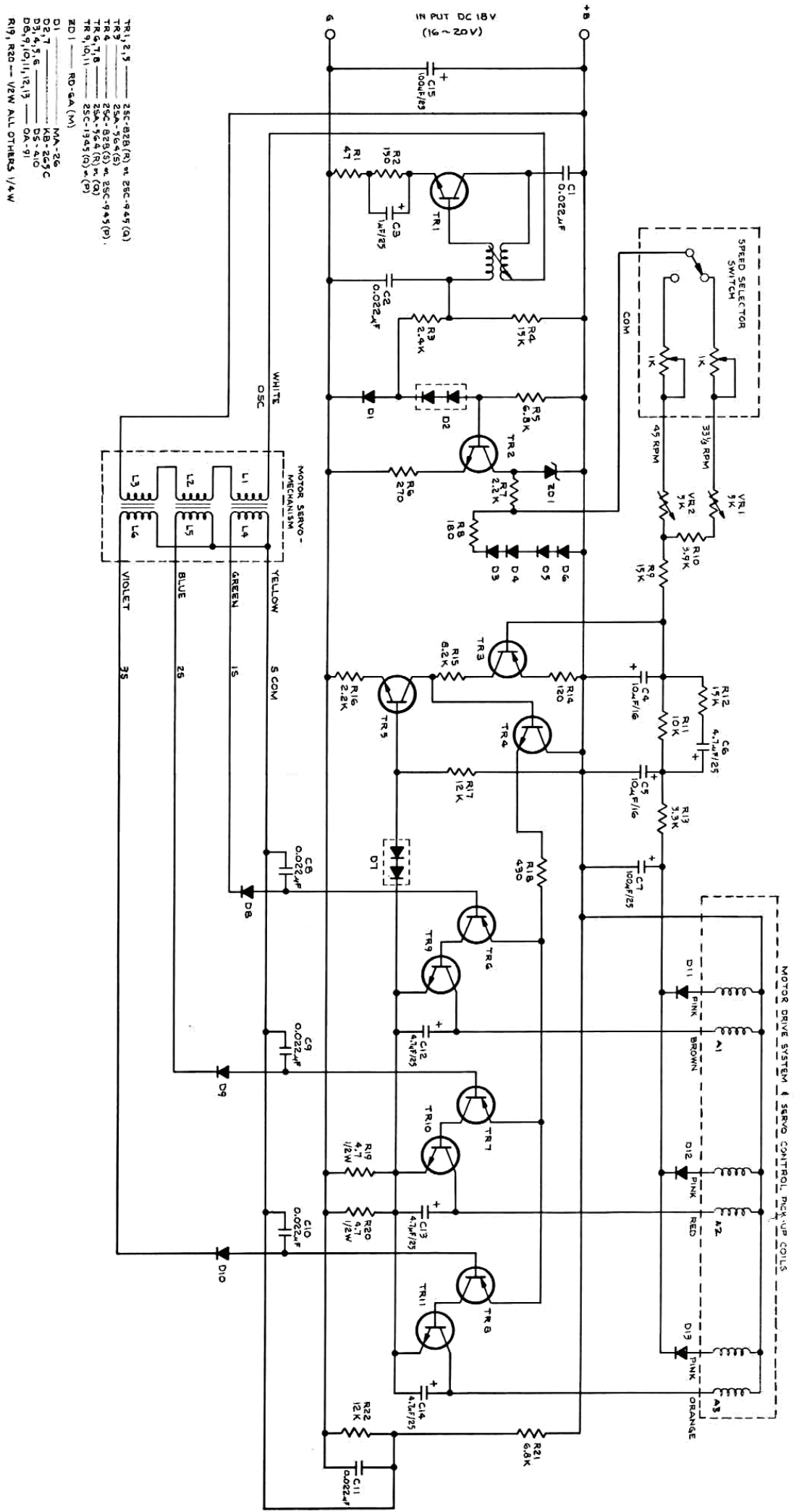

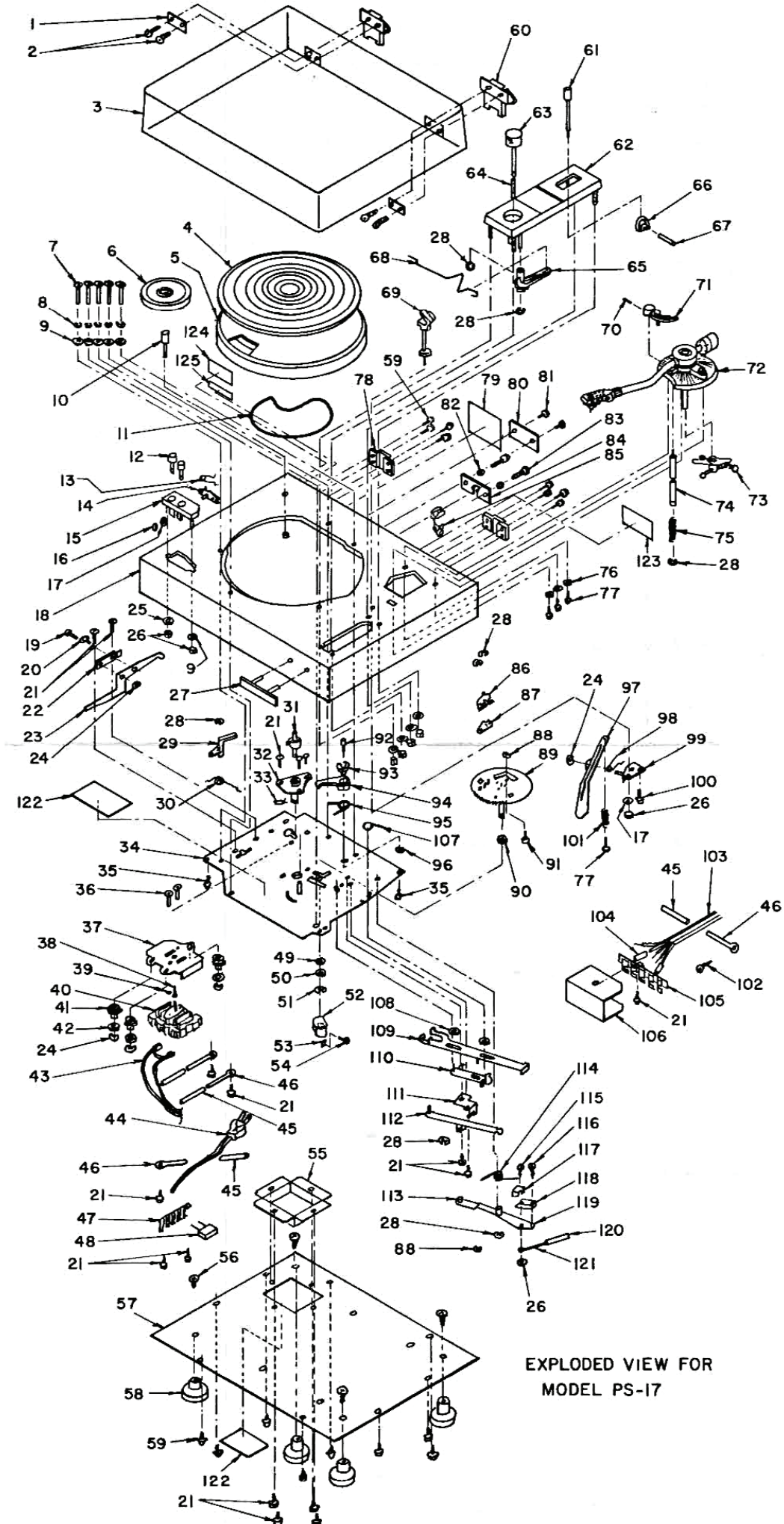

EXPLODED VIEW FOR
MODEL PS-17

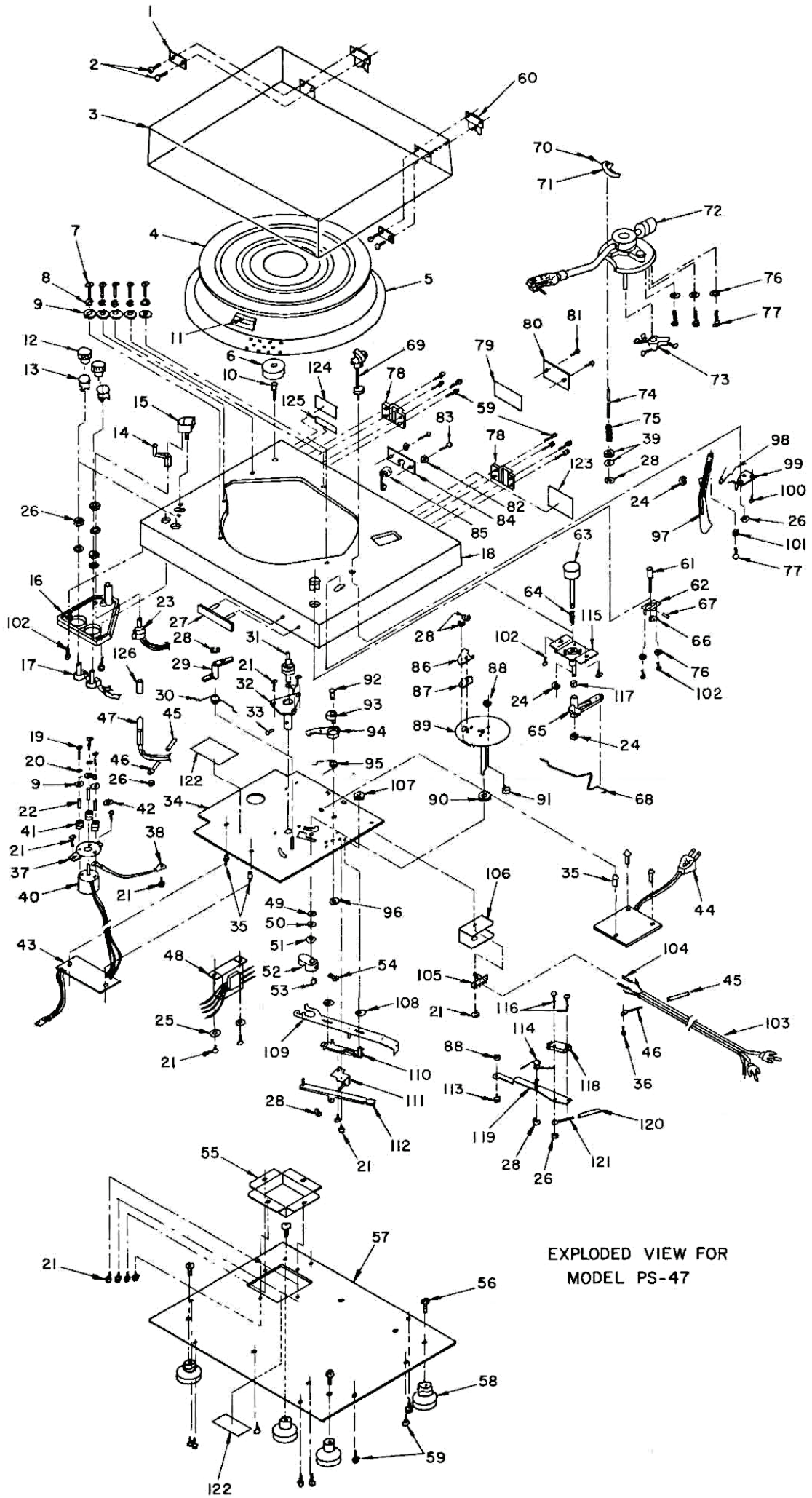

EXPLODED VIEW FOR
MODEL PS-47

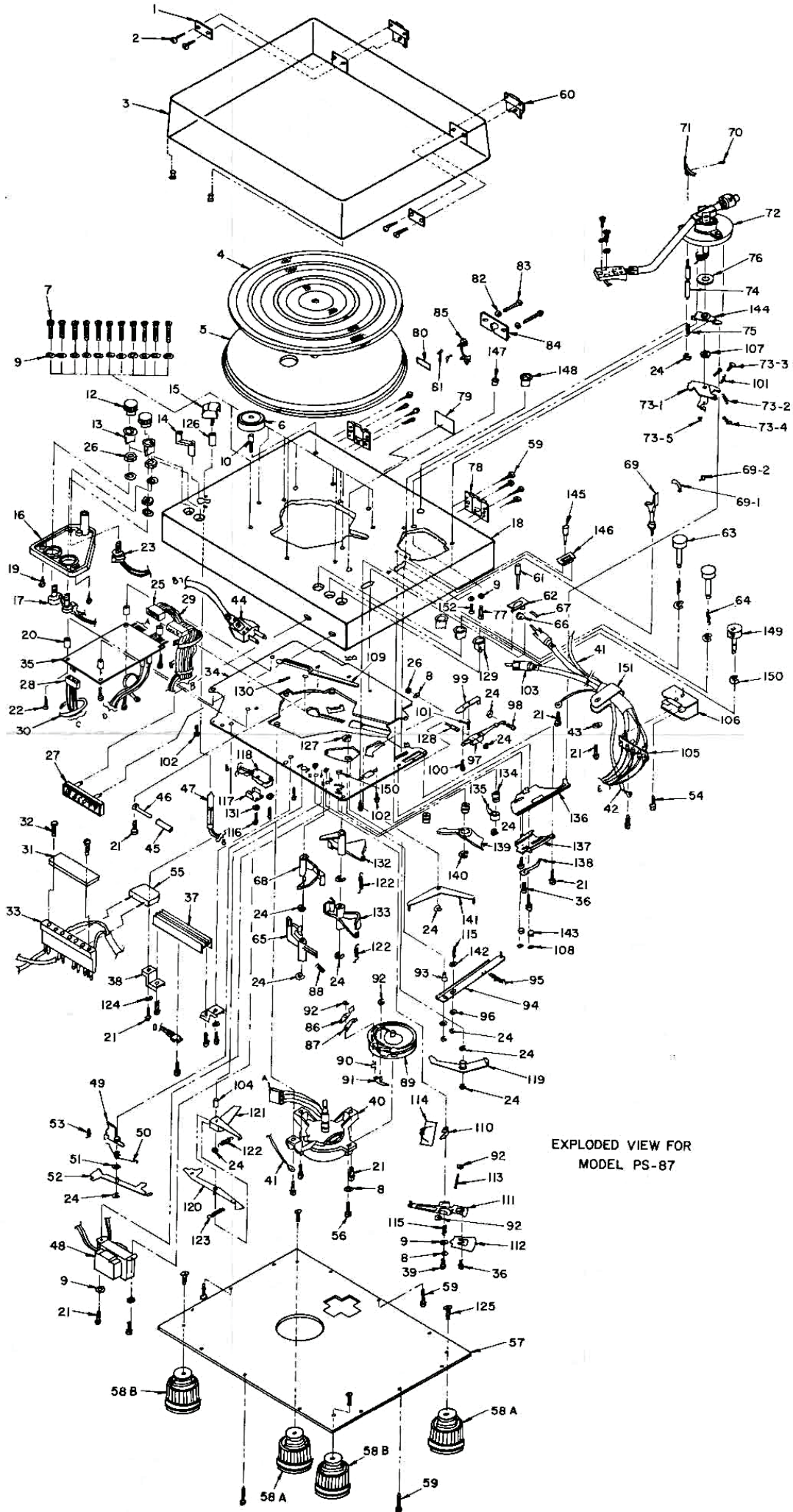

EXPLODED VIEW FOR
MODEL PS-67

SCHEMATIC DIAGRAM & POWER SUPPLY PCB 76

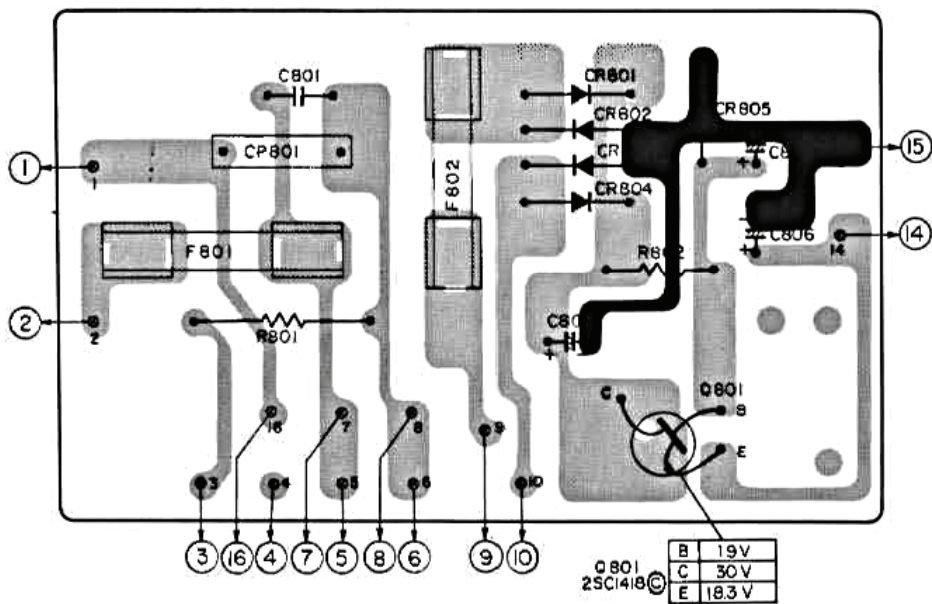
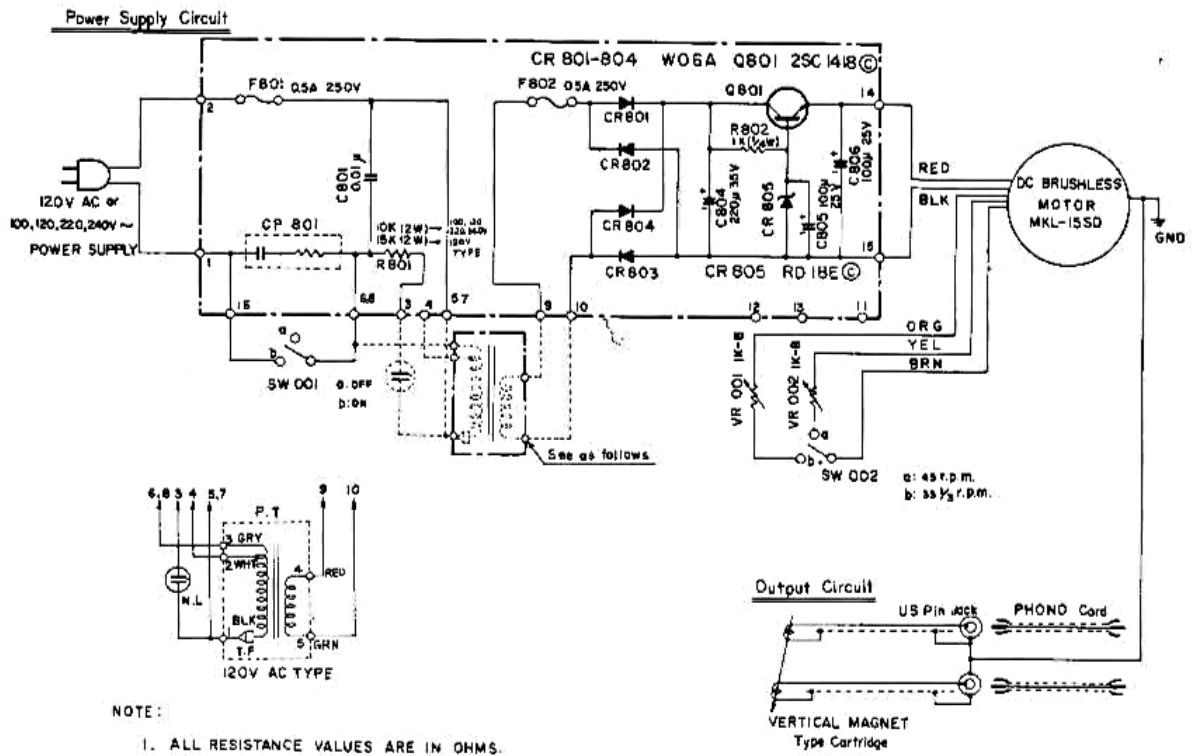



Corporate Headquarters: H. H. SCOTT, INC., 20 Commerce Way, Woburn, Mass. 01801, Tel: 617-933-8800.

CANADA: Paco Electronics Ltd., 45 Stinson Street, Montreal Quebec H4N 2E1, Tel: 514-748-6787.

EUROPE: Head Office SYMA INTERNATIONAL S.A., 15a Rue des Moineaux, 1000 Brussels. Tel: 513.45.30.