

Schematic Diagram for Model-464

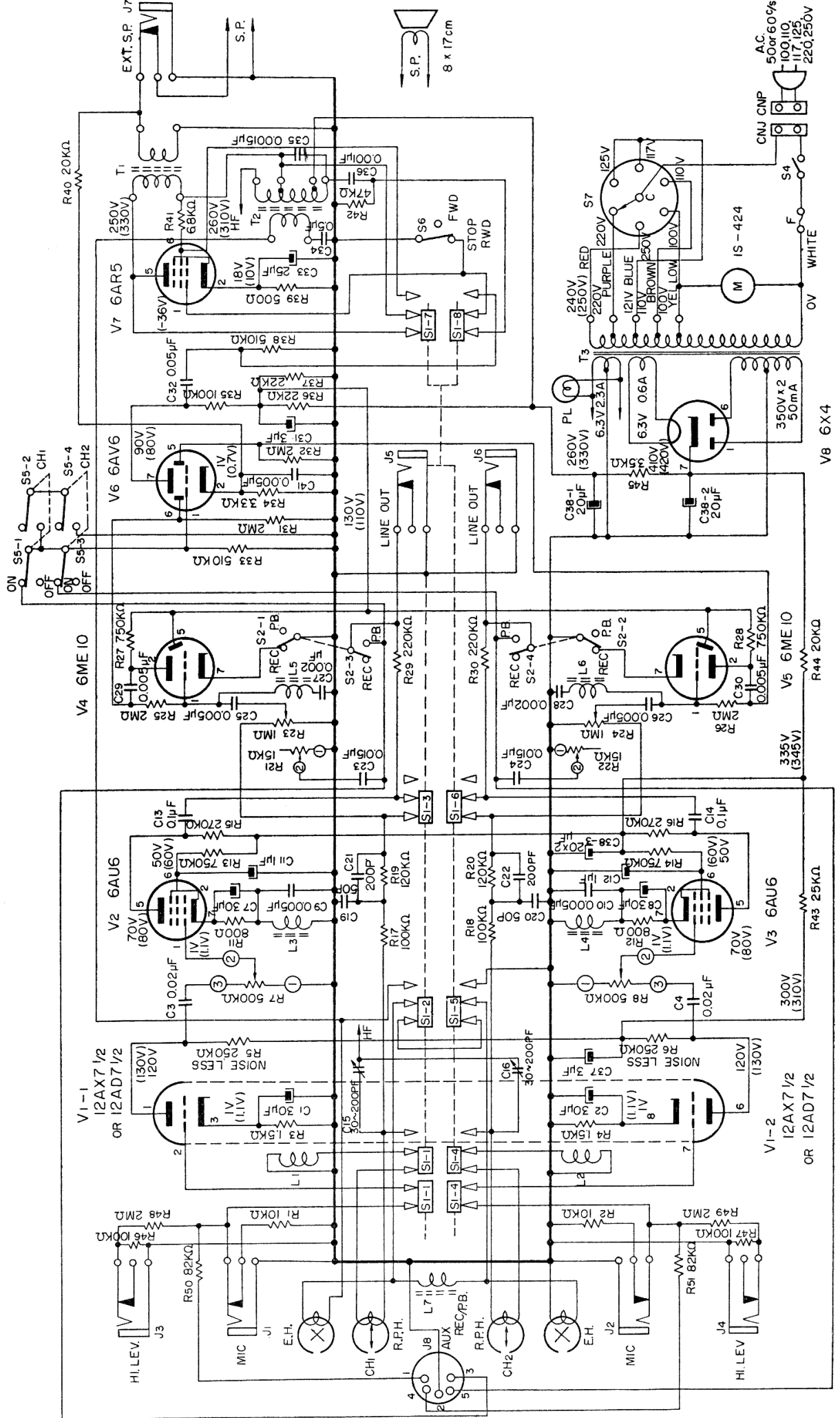

Removal of Top Panel

1. Remove three Philips screws (a) on the top panel.
2. Take off Tape Speed Selector Knob and Play / Stop / Rewind Selector by loosening the set screws.
3. Take off Fast Forward Lever, Instant Stop Lever and Head Cover by pulling straight up. (Fig. 4)

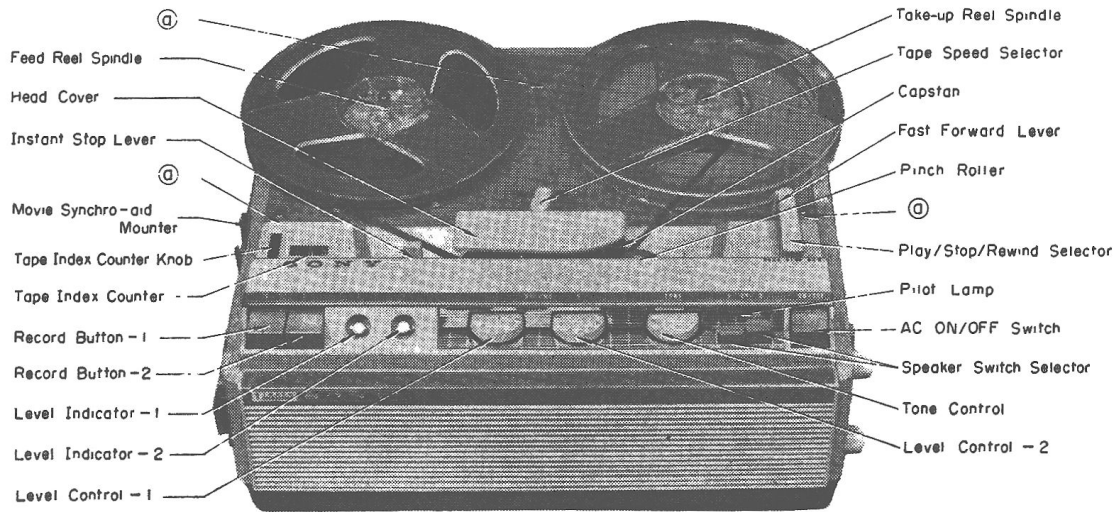

(Fig. 4)

Removal of Front Panel

1. Remove two Philips screws (b) near Head Cover.
2. Remove two Philips screws (c) at each side of Front Panel. (Fig. 5)

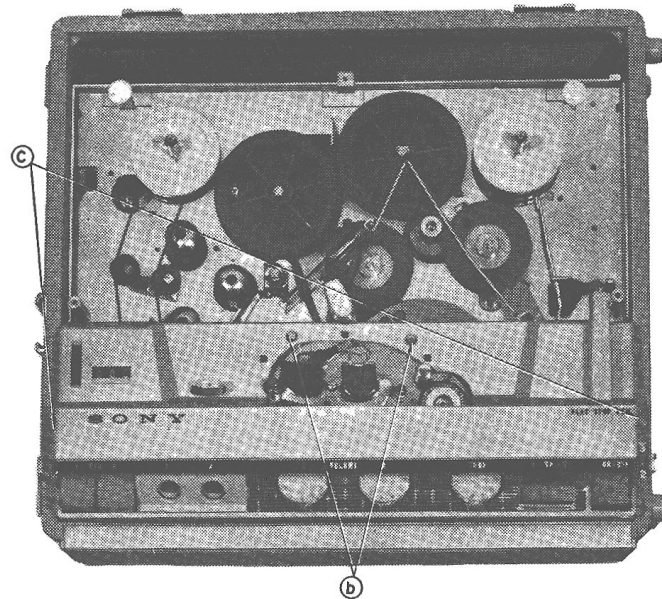

(Fig. 5)

Removal of Chassis

1. Remove four Philips screws (d), two on the Handle side of the Cabinet and the others on the opposite side of the Cabinet. (Fig. 1)
2. Turn over the machine upside down and put it on a table covered with soft cloth to avoid scratching.
3. Take off bottom of the Cabinet by removing one Philips screw (e) near Ventilation Grille at the bottom of the Cabinet.

Removal of Circuit Board

1. Remove two screws on the Chassis, one (f) between the Motor and the Enamelled Resistor R45 and the other (g) between Output Transformer T1 and Trimmer Capacitor C15.
2. Remove two screws, one (h) on the Chassis between the Output Transformer T1 and the Trimmer Capacitor C16 and the other (i) under Osc. Transformer T2.
3. Remove one screw (j) at the middle-left side on the Circuit Board.
4. Remove one screw (k) on the Chassis near S1. (Fig. 6)

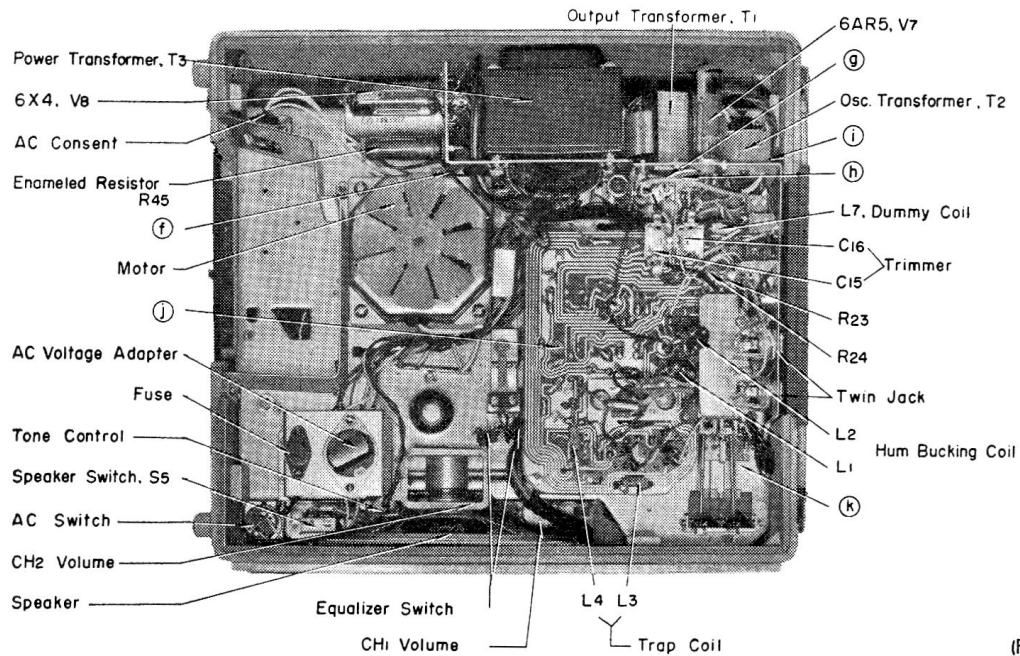

(Fig. 6)

Motor

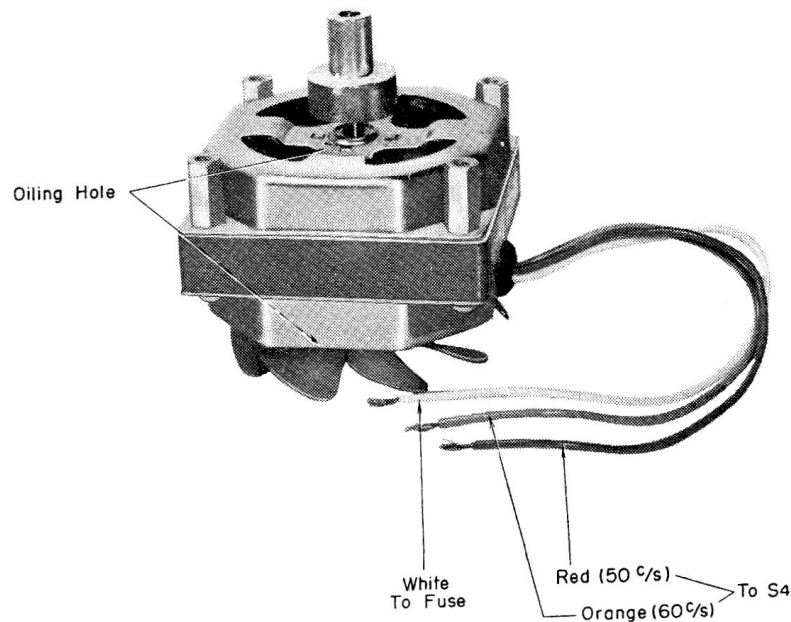

Amplifier Section of Model-464

—Parts Side—

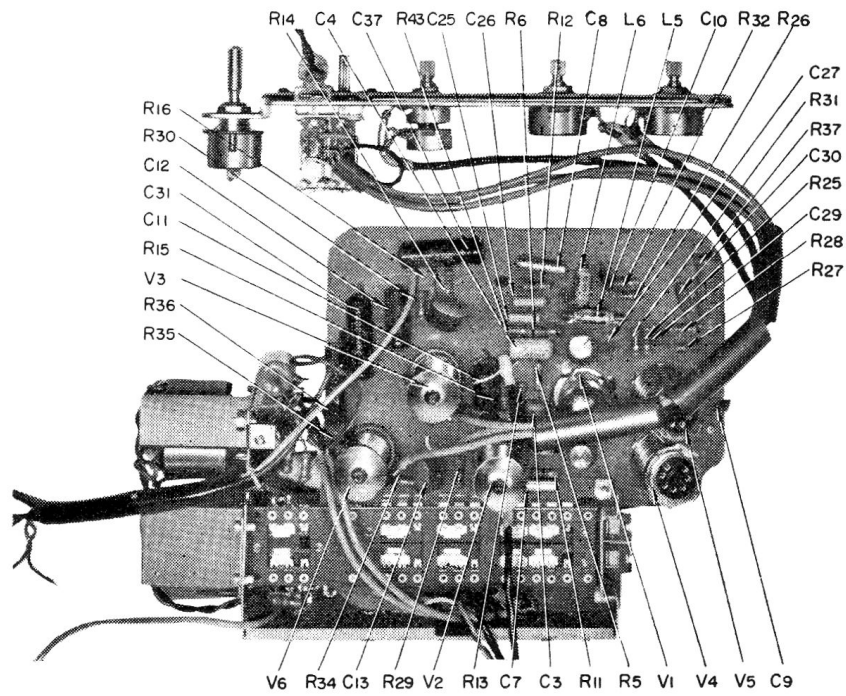

Amplifier Section of Model-464

—Printed Side—

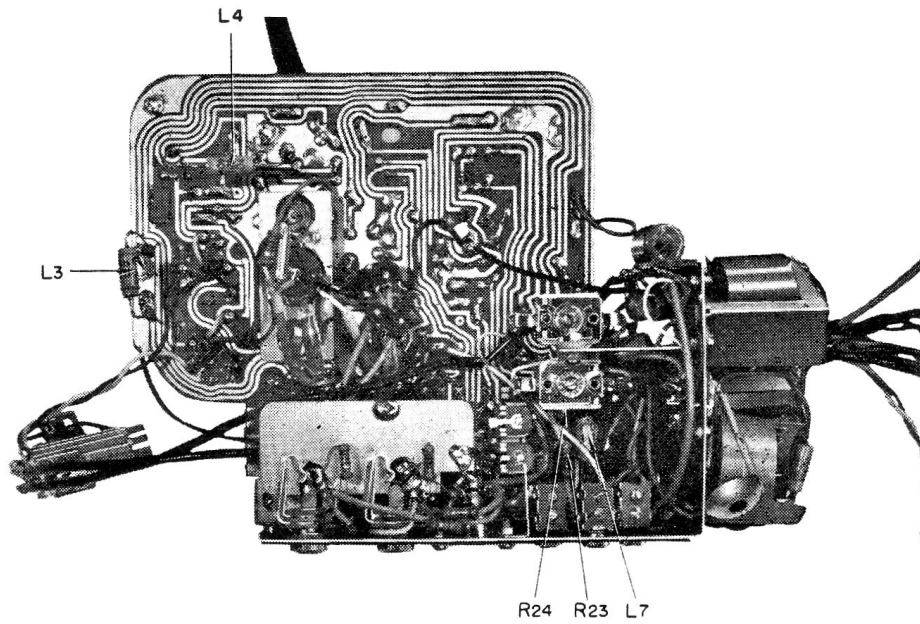

Adjustments and Alignments of Tape recorder Model-464

Electronic Section

1) Head Azimuth Alignment

1. Connect an 8 ohm load resistor and VTVM to external speaker jack J7 as shown in Fig. 7.

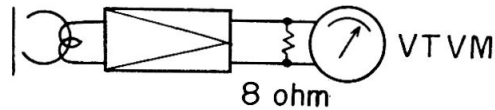

(Fig. 7)

2. First, place the Channel Selector Knob in "CH₁" position.
3. With the machine in stereo mode, thread the alignment tape and play the 7,000 c/s signal recorded on the tape.
4. Turn Volume Control Knob of channel 1 so as to obtain the reading of 0 db (0.775 V) on the VTVM meter.
5. Adjust the azimuth alignment screw located on the right side of the Rec/PB head to obtain the maximum reading on the VTVM meter.

Next, place the Channel Selector Knob in "CH₂" position. Execute the same procedure as above (3-5). The difference between the maximum readings of "CH₁" and "CH₂" on the VTVM meter must be within 2 db.

2) Recording Bias

1. Set the machine on "Record."
2. Connect VTVM across winding of the Rec/PB head of Channel 1 (Channel 2).
3. Set the Potentiometer R 7 (R 8) at the middle position.
4. Adjust the Trimmer Capacitor C15 (C16) so that the VTVM indicates approx. 65 volts.

3) Recording Level

1. Set the machine on "Record."
2. Ground the control grid of oscillator tube 6AR5.
3. Apply 1,000 c/s signal of -55 db (1.35 mV) to MIC INPUT jack J₁ (J₂) and adjust the Potentiometer R7 (R8) so that the signal level at the plate of Vacuum Tube V2 (V3) reads 10 db (6V) on the VTVM meter.
4. Adjust the Potentiometer R 23 (R 24) so that the Magic Eye is nearly closed as shown in Fig. 8-a.

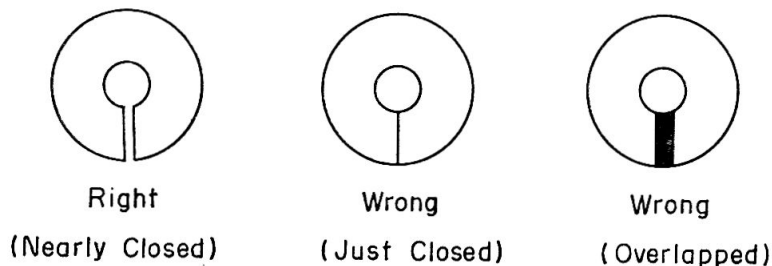

Fig. 8-a

Fig. 8-b

Fig. 8-c