

4-4. PRINTED WIRING BOARDS

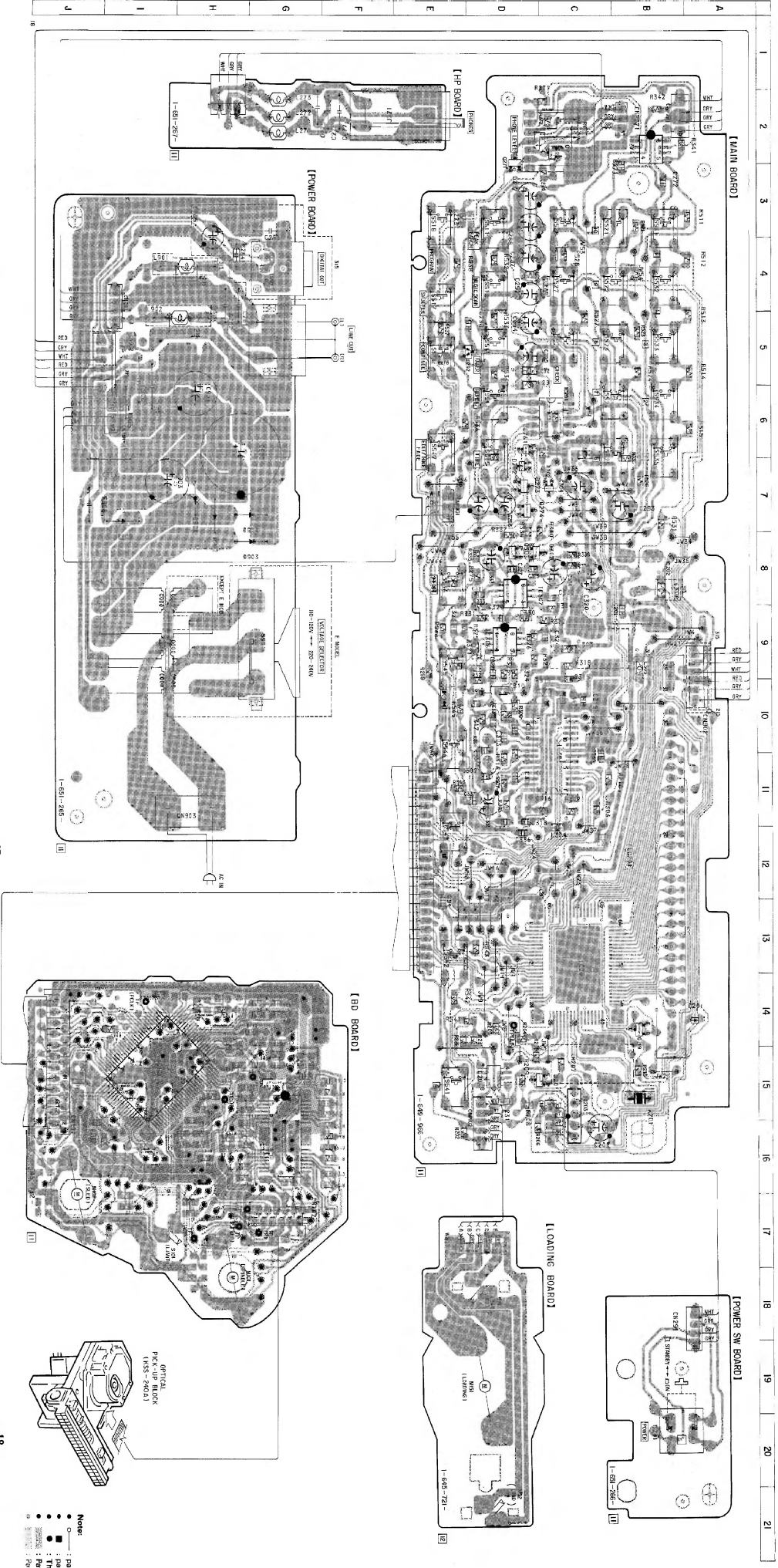

● Semiconductor Location

Ref. No.	Location
D201	A-14
D202	C-7
D261	D-6
D262	D-7
D292	D-5
D901	H-7
D902	H-7
D903	H-8
D904	H-7
D905	I-7
IC101	I-15
IC102	G-16
IC201	C-13
IC202	B-8
IC203	C-15
IC204	B-2
IC271	G-4
IC281	C-6
IC291	C-10
IC301	C-9
IC306	D-8
IC307	D-8
C201	D-15
C219	B-14
C271	B-2
C272	C-2
C273	D-7
C274	D-7
C301	D-8
C302	D-8

Note:
 ○ parts extracted from the component side.
 ● parts mounted on the conductor side.
 ■ parts mounted on the rear side.
 ● parts on the side which is seen.
 ○ parts on the rear side.

BA6297AFP

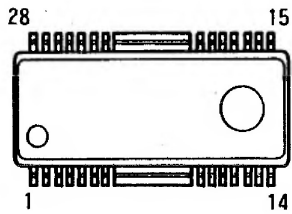

CXD2515Q

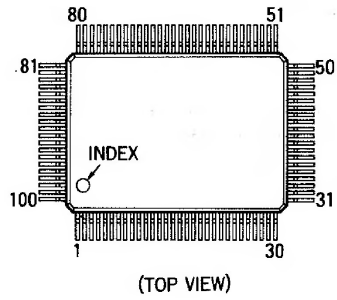

CXP82316-037Q

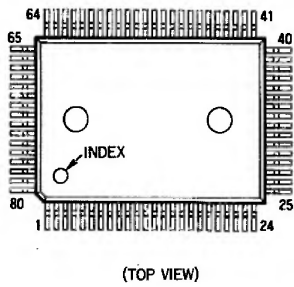

GP1U58XB

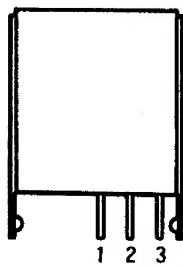

- 1 Vout
- 2 Vcc
- 3 GND

M5293L

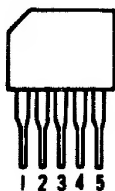

11ES2

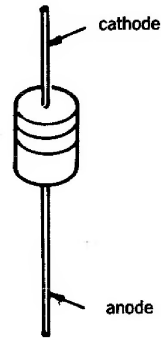

DA204K

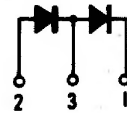
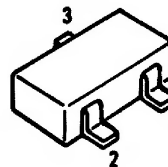

DAN202U

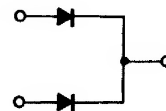
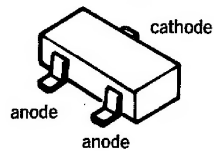

DAP202U

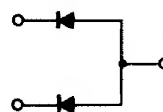
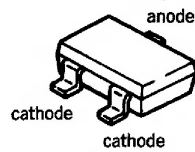

DTZ10B

