

ST-5950SD

UK Model
AEP Model



FM STEREO/FM-AM TUNER

SPECIFICATIONS

GENERAL

Outputs:	FIXED: 750 mV, 10 k Ω VARIABLE: 0–2 V, 3 k Ω FM DISCRI: 140 mV, 10 k Ω HEADPHONES: 0–200 mV (8 Ω headphones)	S/N Ratio: 76 dB (MONO) 70 dB (STEREO)
Power Requirements:	110, 127, 220 or 240 V ac adjustable, 50/60 Hz	Harmonic Distortion: at 100 Hz, 1 kHz 0.1% (MONO) 0.2% (STEREO) at 10 kHz 0.15% (MONO) 0.4% (STEREO)
Power Consumption:	32 W	Stereo Separation: 40 dB at 100 Hz 50 dB at 1 kHz 40 dB at 10 kHz
Dimensions:	Approx. 460 (w) x 168 (h) x 331 (d) mm 18 $\frac{1}{8}$ (w) x 6 $\frac{5}{8}$ (h) x 13 (d) inches Including projecting parts and controls	Frequency Response: 20 Hz–15 kHz $\begin{matrix} + 0.2 \\ - 1.0 \end{matrix}$ dB
Weight:	Approx. 9.3 kg, 20 lb 8 oz (net) 11.7 kg, 25 lb 13 oz (in shipping carton)	19 kHz, 38 kHz Suppression: 70 dB
		Muting Level: Approx. 5 μ V
FM SECTION		AM SECTION
Tuning Range:	87.5 – 108 MHz	Tuning Range: 530 – 1,605 kHz
Antenna Terminals:	300 Ω balanced 75 Ω coaxial cable input	Antenna: Built-in ferrite-bar antenna and external antenna terminal
Intermediate Frequency:	10.7 MHz	Intermediate Frequency: 468 kHz
Usable Sensitivity:	1.5 μ V (MONO), IHF 1.4 μ V, S/N = 26 dB (40 kHz deviation)	Usable Sensitivity: 250 μ V/m built-in antenna 100 μ V external antenna at 1,000 kHz
Sensitivity at 50 dB Quieting:	2.8 μ V (MONO) 35 μ V (STEREO)	Image Rejection: 45 dB at 1,000 kHz
Image Rejection:	90 dB	S/N Ratio: 50 dB at 50 mV/m
IF Rejection:	100 dB	Harmonic Distortion: 0.5% at 50 mV/m, 400 Hz
Spurious Rejection:	100 dB	
AM Suppression:	56 dB	
Capture Ratio:	1.0 dB	
Selectivity:	85 dB	

* This set is equipped with DOLBY FM circuit.
'Dolby' and the double-D symbol are the trade marks
of Dolby Laboratory Inc. Noise reduction system
manufactured under license from Dolby Laboratory Inc.

SONY[®]

SERVICE MANUAL

SECTION 1
BLOCK DIAGRAM

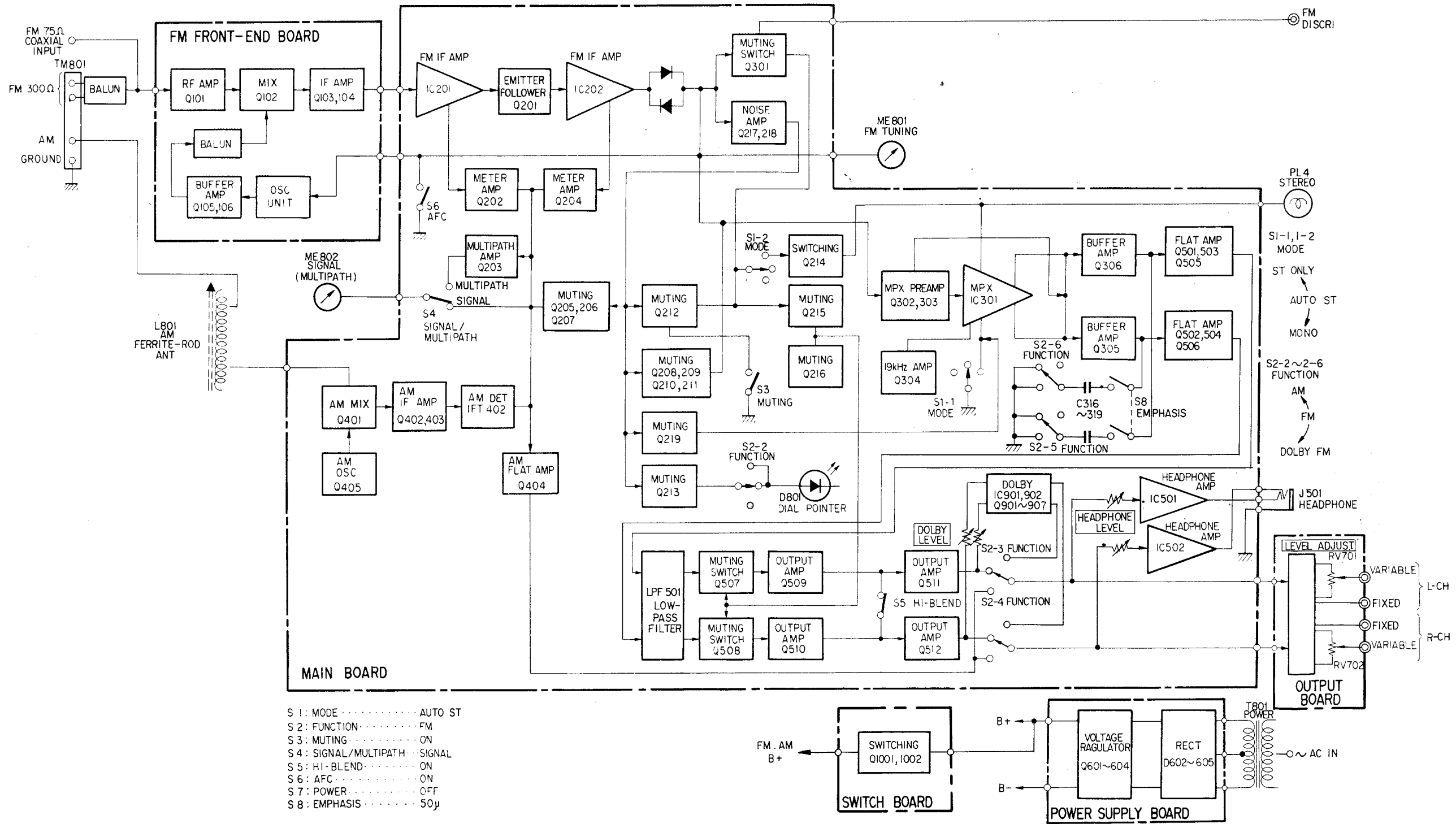

SECTION 2

ALIGNMENTS AND ADJUSTMENTS

FM FREQUENCY COVERAGE AND TRACKING ALIGNMENT

Never attempt alignment of the fm front-end section for the fm frequency coverage and tracking alignment. If the fm frequency coverage alignment is required, replace the fm front-end board.

In the case of tracking alignment, ask your nearest SONY Service Station to send your set to the Factory Service Center.

AM FREQUENCY COVERAGE AND AM TRACKING ALIGNMENT

Setup:

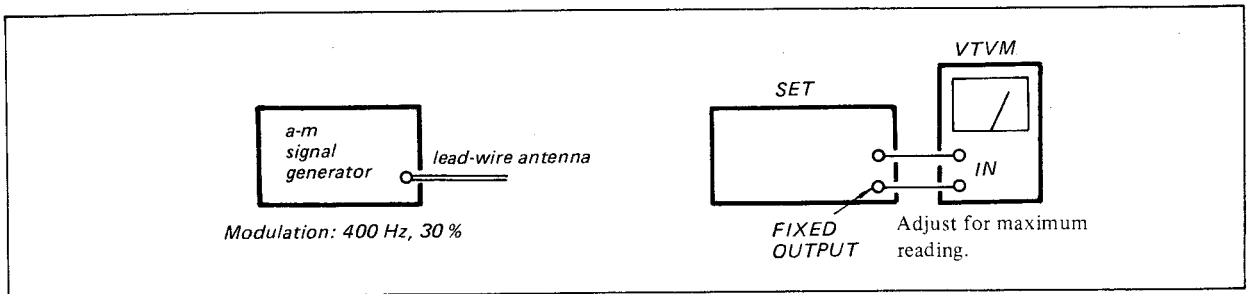

Step	AM FREQUENCY COVERAGE ALIGNMENT	DIAL INDICATION
1.	L402 (550 kHz)	550 kHz
2.	CT402 (1,600 kHz)	1,600 kHz

Note: Repeat step 1 and 2 several times, and finish the alignment at step 2.

Step	AM TRACKING ALIGNMENT
1.	L801 (600 kHz)
2.	CT401 (1,400 kHz)

Note: Repeat step 1 and 2 several times, and finish the alignment at step 2.

DOLBY LEVEL ADJUSTMENT
(See page 6.)
RT1001 (R-CH)
RT1002 (L-CH)

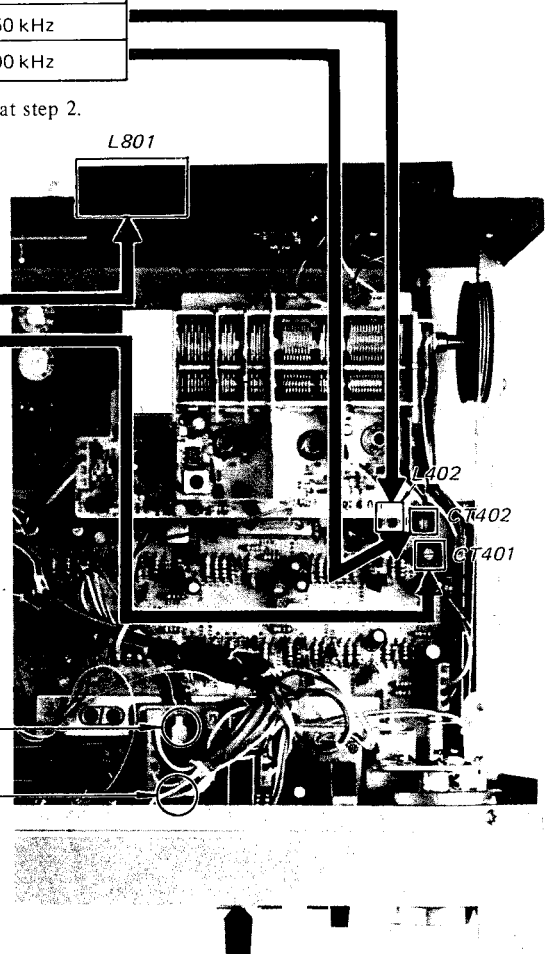

FM DOLBY ADJUSTMENT

Setup:

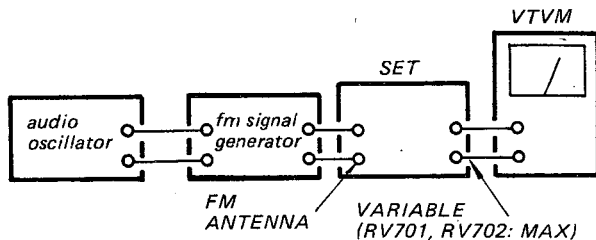

FM Signal Generator Setting:

Carrier frequency: 98 MHz
Modulation: See the following procedures.
Output level: 1 mV (60 dB)
FUNCTION switch: FM DOLBY

Procedure:

A) DOLBY LEVEL ADJUSTMENT

Modulation: 400 Hz,
75 kHz deviation (100%)

1. Tune the set to 98 MHz.
2. Adjust RT1001 (R-CH) and RT1002 (L-CH) for 2 V (8.2 dB) reading on the VTVM.

B) DOLBY ACTUATING POINT ADJUSTMENT

1. Change the modulation to 5,000 Hz.
2. Lower the modulation level so that the VTVM reading drops 25.9 dB from the level obtained at the above DOLBY level adjustment.
3. Adjust RT901 (L-CH) and RT902 (R-CH) so that the VTVM reading drops 36 ± 1 dB from the output level obtained at the above DOLBY level adjustment.

FM DOLBY ACTUATING POINT ADJUSTMENT

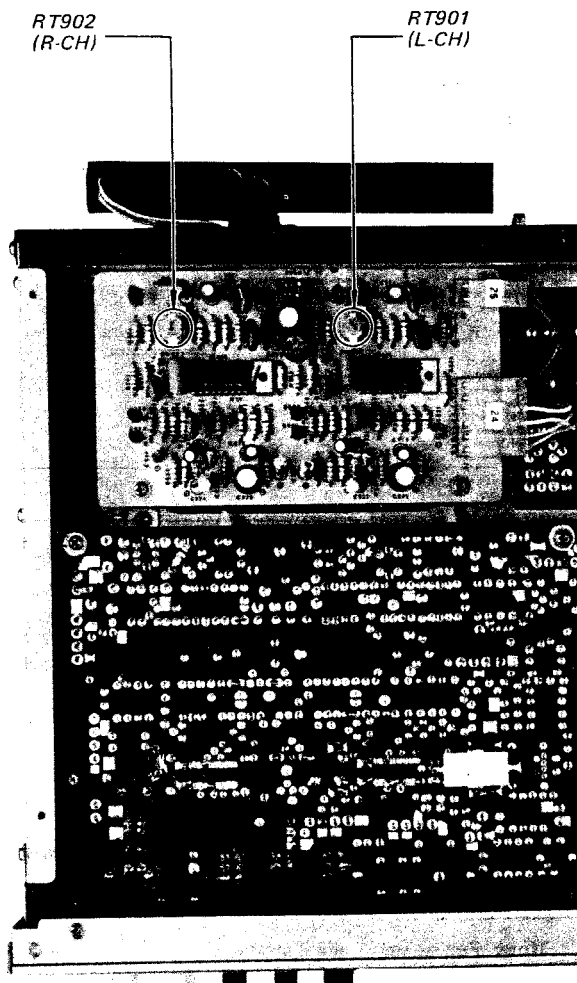

FM OUTPUT LEVEL ADJUSTMENT

Setup:

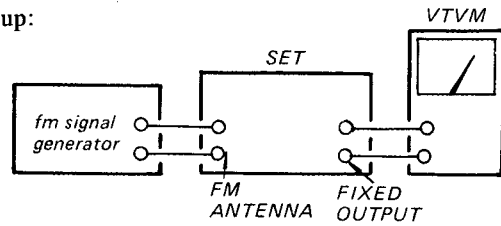

FM Signal Generator Setting:

- Carrier frequency: 98 MHz
- Modulation: 400 Hz, 75 kHz deviation (100%)
- Output level: 1 mV (60 dB)

Procedure:

Adjust RT503 (R-CH) and RT504 (L-CH) for 750mV (-0.3 dB) reading on the VTVM.

MUTING ADJUSTMENT

Setup:

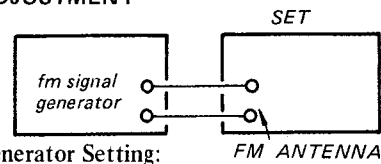

FM Signal Generator Setting:

- Carrier frequency: 98 MHz
- Modulation: 400 Hz, 75 kHz deviation (100%)
- Output level: 1 mV (60 dB)

Procedure:

1. Turn the MUTING switch ON.
2. Adjust RT203 so that the muting circuit begins to operate at the symmetrical deflection point of TUNING meter when detuning the tuner to higher or lower frequencies than 98 MHz.

FM IF ALIGNMENT

Setup:

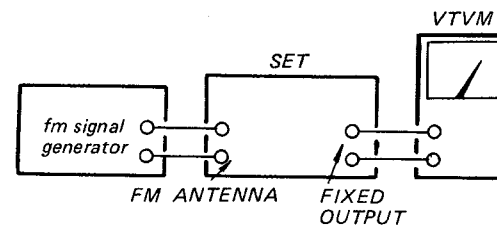

FM Signal Generator Setting:

- Carrier frequency: 98 MHz
- Modulation: 400 Hz, 75 kHz deviation (100%)
- Output level: Measurable minimum.

Procedure:

Tune the set to 98 MHz and adjust L106 for maximum reading on the VTVM.

SIGNAL METER ADJUSTMENT

Setup:

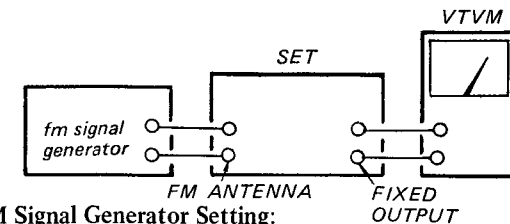

FM Signal Generator Setting:

- Carrier frequency: 98 MHz
- Modulation: 400 Hz, 75 kHz deviation (100%)
- Output level: 3.2 mV (70 dB)

Procedure:

Tune the set to 98 MHz and adjust RT202 for specified pointer position (See figure below.) on the SIGNAL meter.

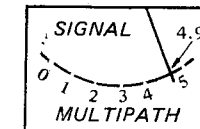

FM STEREO SEPARATION ADJUSTMENT

Setup:

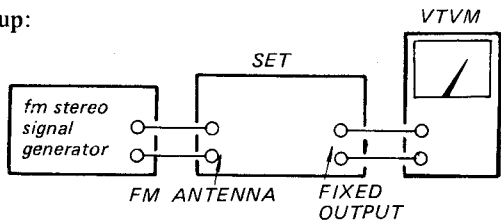

FM Stereo Signal Generator Setting:

- Main carrier frequency: 98 MHz
- Output level: 1 mV (60 dB)
- Mode: Stereo
- Audio (400 Hz) Mod: 67.5 kHz deviation (90%)
- Pilot (19 kHz) Mod: 7.5 kHz deviation (10%)
- FUNCTION switch: FM

Procedure:

1. Set the signal generator channel selector to L-CH.
2. Tune the set to 98 MHz.
3. Connect the VTVM to the FIXED OUT "L-CH" of the set and calibrate the VTVM for 0 dB reading.
4. Turn the stereo signal generator channel selector from L-CH to R-CH and adjust RT501 for minimum output on the VTVM.
5. Connect the VTVM to the FIXED OUT "R-CH" of the set and calibrate the VTVM for 0 dB reading.
6. Turn the stereo signal generator channel selector from R-CH to L-CH and adjust RT502 for minimum output on the VTVM.

19 kHz ADJUSTMENT

A) With Frequency Counter

Setup:

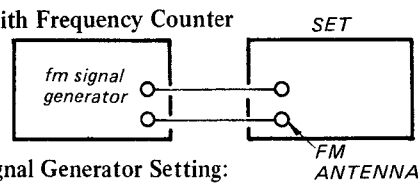

FM Signal Generator Setting:

- Carrier frequency: 98 MHz
- Modulation: 400 Hz, 75 kHz deviation (100%)
- Output level: 1 mV (60 dB)
- FUNCTION switch: FM

Procedure:

1. Tune the set to 98 MHz.
2. Adjust RT301 for 19 kHz ± 100 Hz on the counter.

B) Without Frequency Counter

1. Tune the set to FM stereo signals.
2. Turn RT301 clockwise or counterclockwise and secure RT301 at the center in lighting-up range of stereo lamp as shown below.

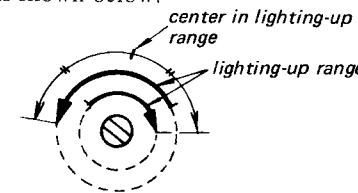

FM DISCRIMINATOR ALIGNMENT

Procedure:

1. Detune the set.
2. Turn the core (secondary side) of IFT201 for null-point reading on the FM TUNING meter.

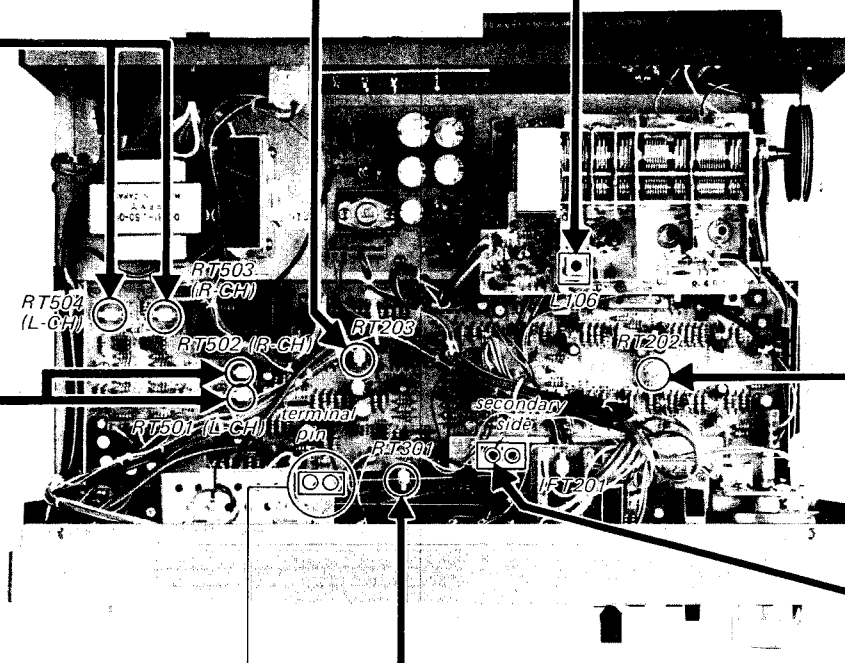
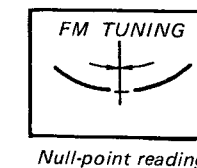

SECTION 3
DIAL CORD STRINGING

FM IF ALIGNMENT

Setup:

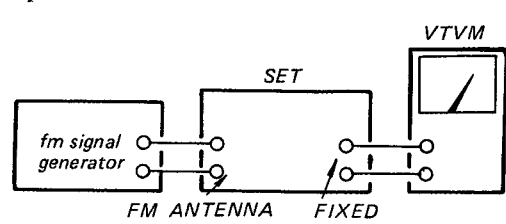

FM Signal Generator Setting:

Carrier frequency: 98 MHz
 Modulation: 400 Hz,
 75 kHz deviation (100 %)
 Output level: Measurable minimum.

Procedure:

Tune the set to 98 MHz and adjust L106 for maximum reading on the VTVM.

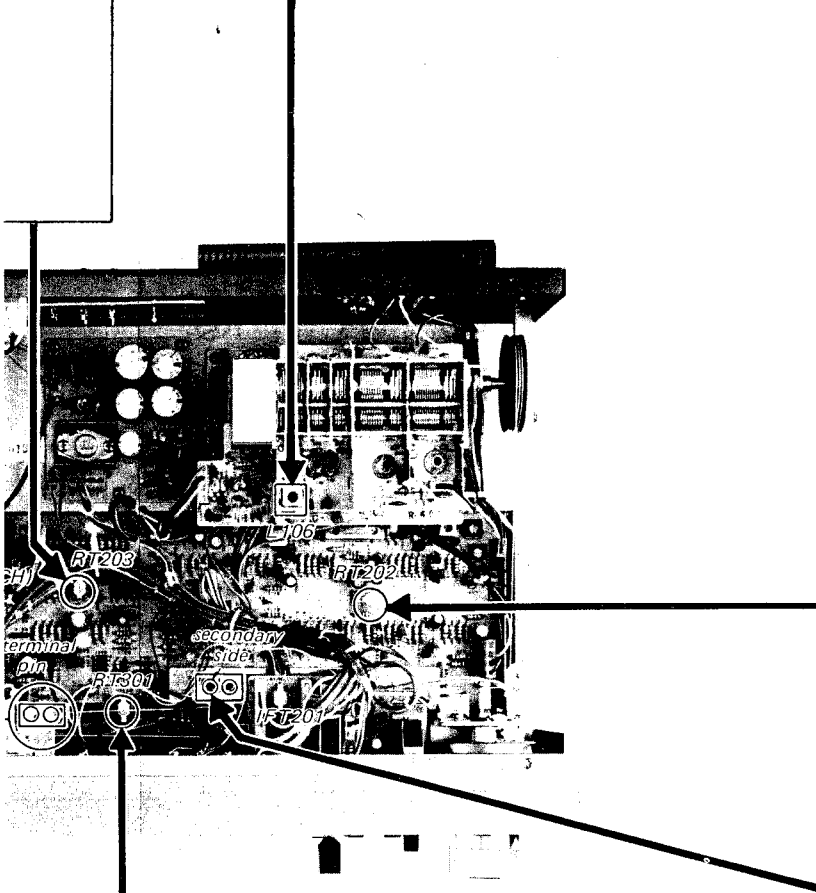

SIGNAL METER ADJUSTMENT

Setup:

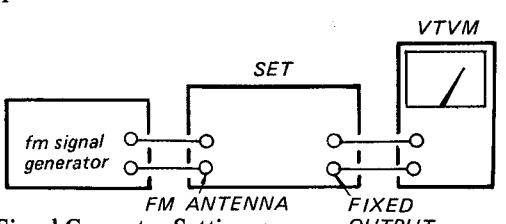

FM Signal Generator Setting:

Carrier frequency: 98 MHz
 Modulation: 400 Hz,
 75 kHz deviation (100 %)
 Output level: 3.2 mV (70 dB)

Procedure:

Tune the set to 98 MHz and adjust RT202 for specified pointer position (See figure below.) on the SIGNAL meter.

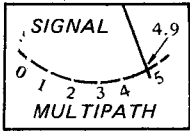

B) Without Frequency Counter

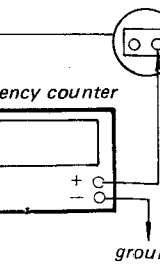

1. Tune the set to FM stereo signals.
2. Turn RT301 clockwise or counterclockwise and secure RT301 at the center in lighting-up range of stereo lamp as shown below.

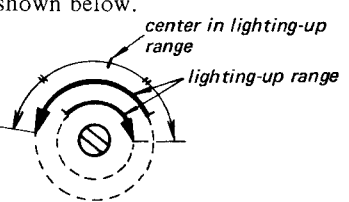

FM DISCRIMINATOR ALIGNMENT

Procedure:

1. Detune the set.
2. Turn the core (secondary side) of IFT201 for null-point reading on the FM TUNING meter.

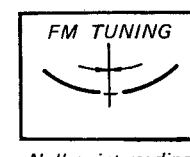
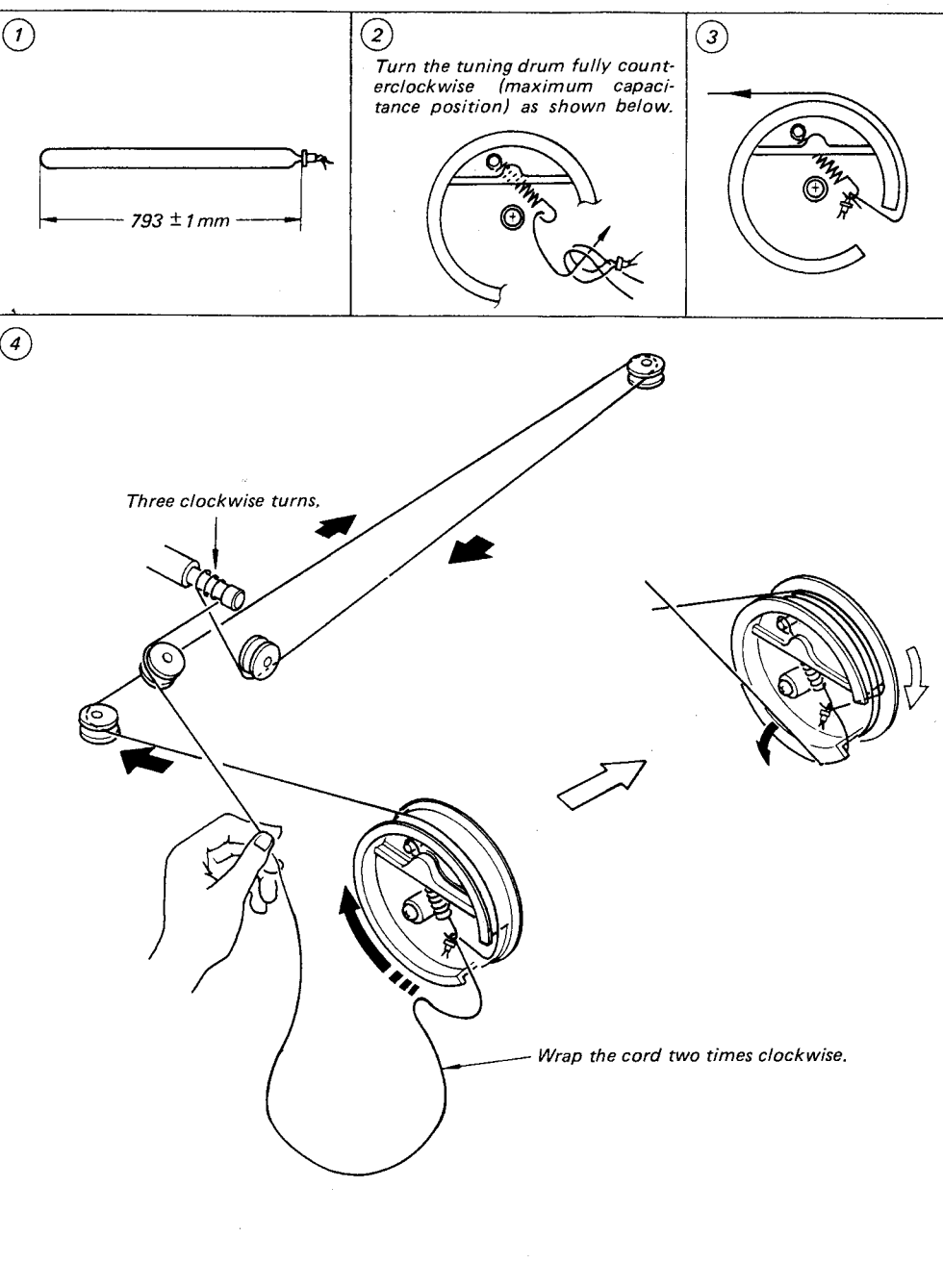
1. Cord length: $793 \pm 1 \text{ mm}$

2. Turn the tuning drum fully counterclockwise (maximum capacitance position) as shown below.

3. Turn the tuning drum fully clockwise.

4. Three clockwise turns. Wrap the cord two times clockwise.

SECTION 4
DIAGRAMS

4-1. SCHEMATIC DIAGRAM

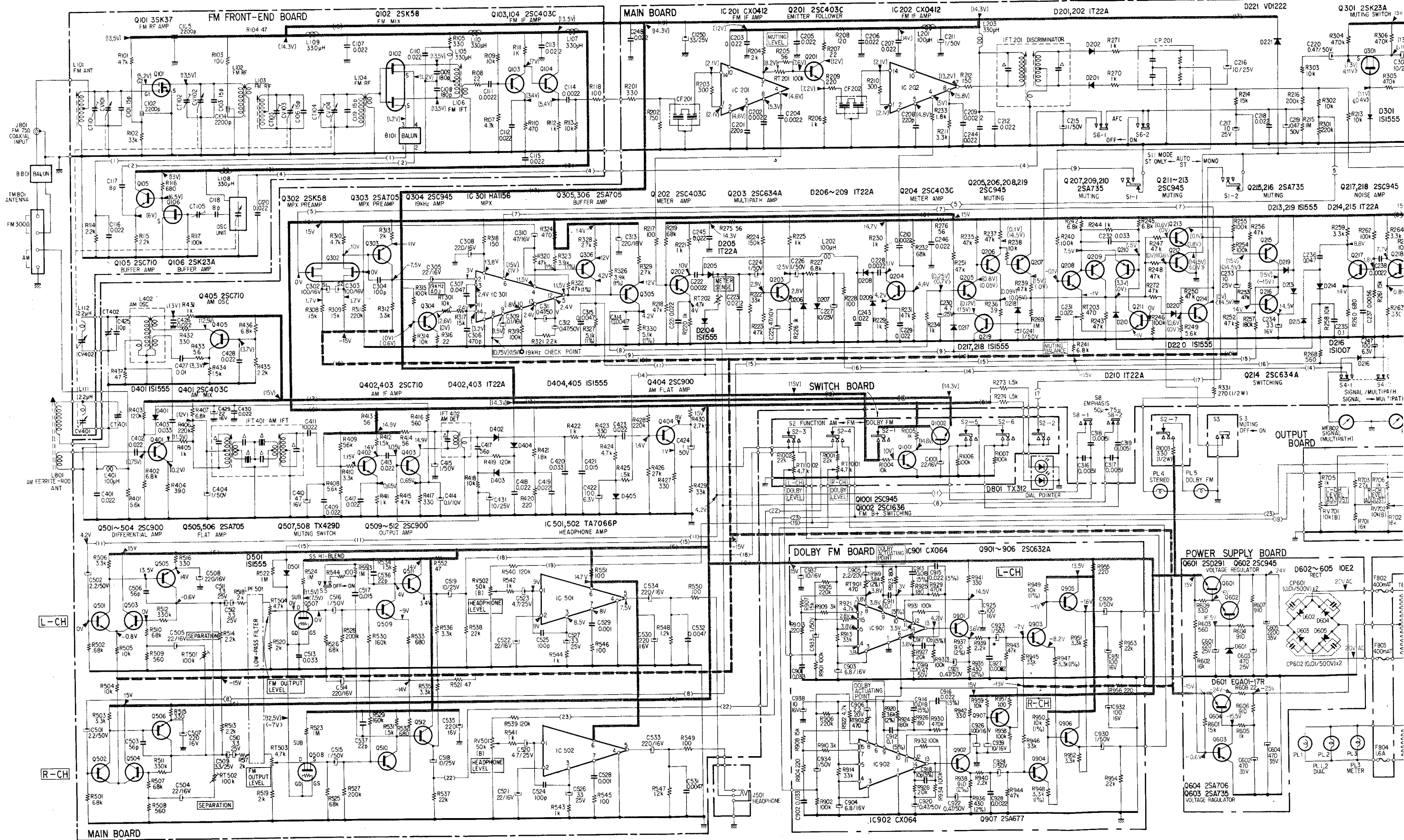

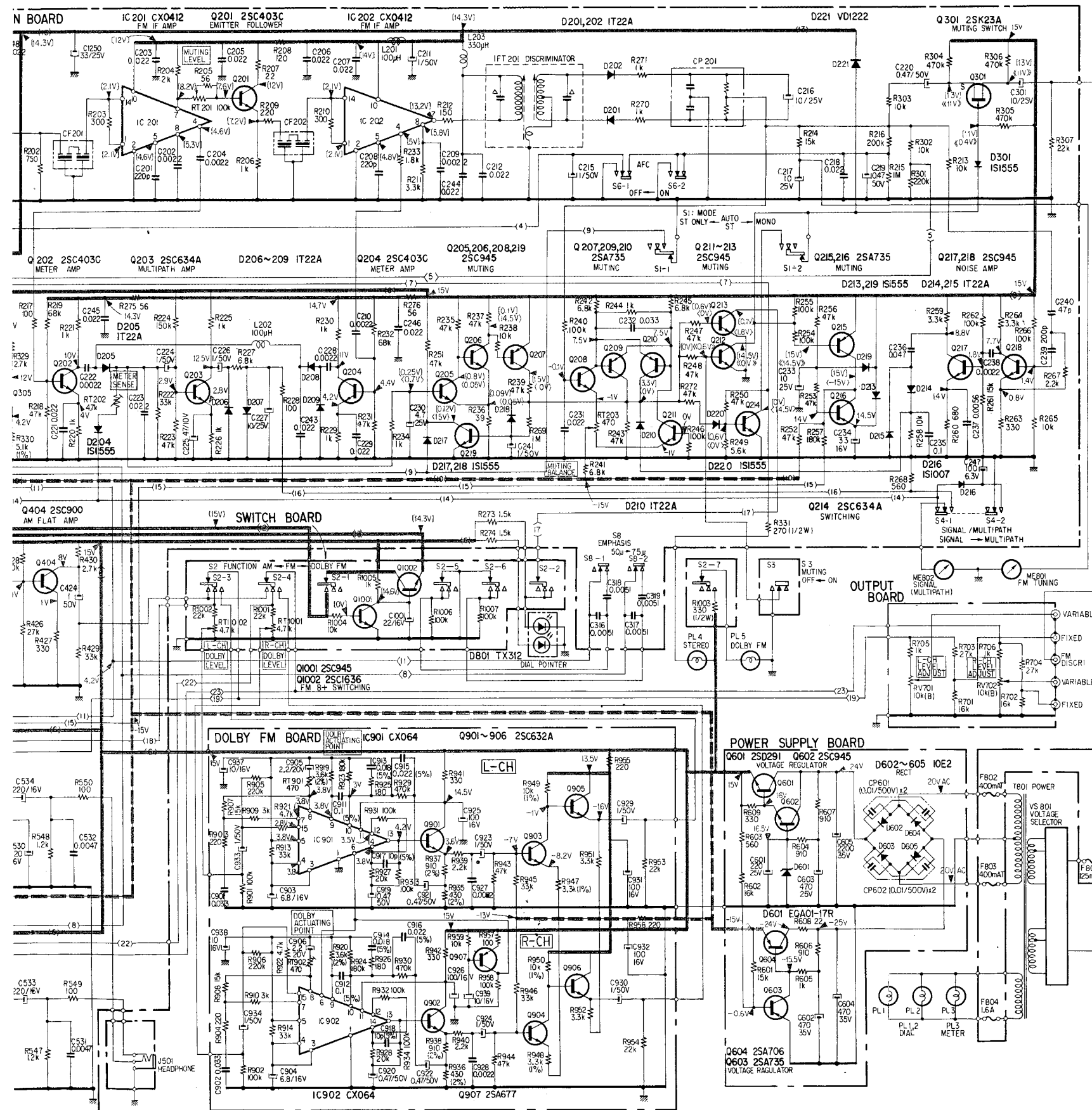

Note:

- All capacitors are in μF unless otherwise noted. 50 or less working volts are omitted except for electrolytic type. $P = \mu\text{F}$
- All resistors are in Ω , $\frac{1}{4}W$, unless otherwise noted. $k = 1,000$ $M = 1,000k$
- Δ indicates internal components.
- ||||| indicates chassis ground.
- --- : B+ line --- : B- line
- (\square %) of resistors and capacitors indicates the tolerance.
- Voltages are DC with respect to ground unless otherwise noted. Readings are taken under no-signal conditions with a VOM (20 $k\Omega/V$).
- () : AM [] : FM < > : FM (signal)
- $\ll \gg$: MUTING SW (S3) ON
- no mark : common

- Voltage variations may be noted due to normal production tolerances.
- AC voltage readings on bias oscillator circuit are taken with a VTVM.
- Switch Mode:

Ref. No.	Switch	Position
S1	MODE	AUTO ST
S2	FUNCTION	FM
S3	MUTING	ON
S4	SIGNAL/MULTIPATH	SIGNAL
S5	HI-BLEND	ON
S6	AFC	ON
S7	POWER	OFF
S8	EMPHASIS	50 μ

- Note:
- Color in () indicates color of sleeving over the end portion of shielded wire.
 - : B+ pattern
 - : B- pattern

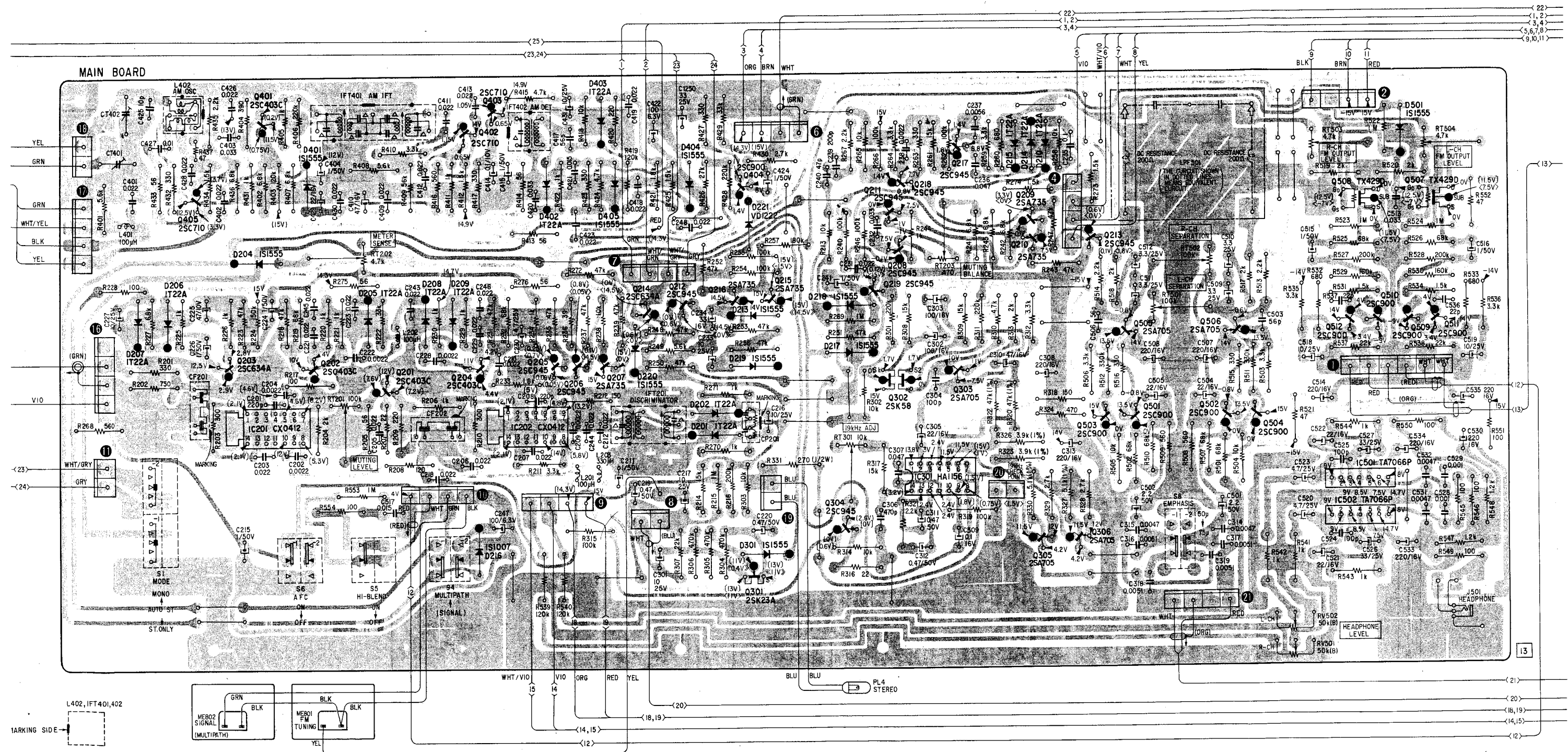

405	203	401	202	201	402	403	205	206	207	214	212	404	215	304	219	211	218	217	303	209,210	213	505	506	512	508	510	507	Q
		IC201			IC202							216	201	217					IC301	215	214	210	502	504	IC501,IC502	509	511	IC
207	206	204	401	205	208	209	216	402	403	405	220	404	202	201	221	213,219,301											501	D

4.3. MOUNTING DIAGRAM
- Conductor Side -

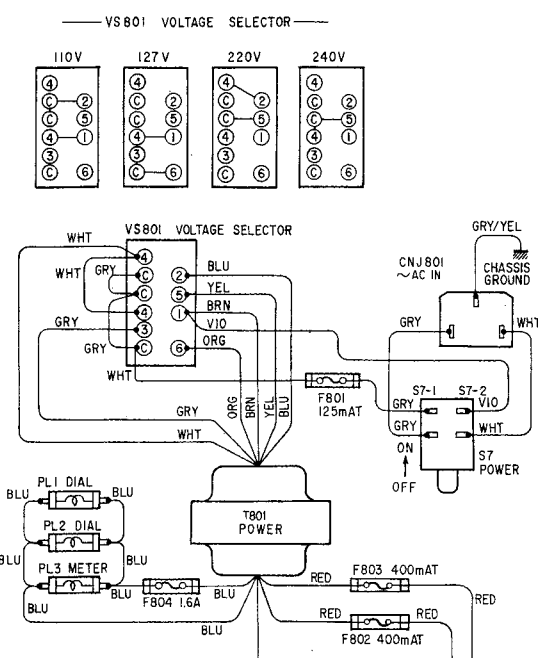
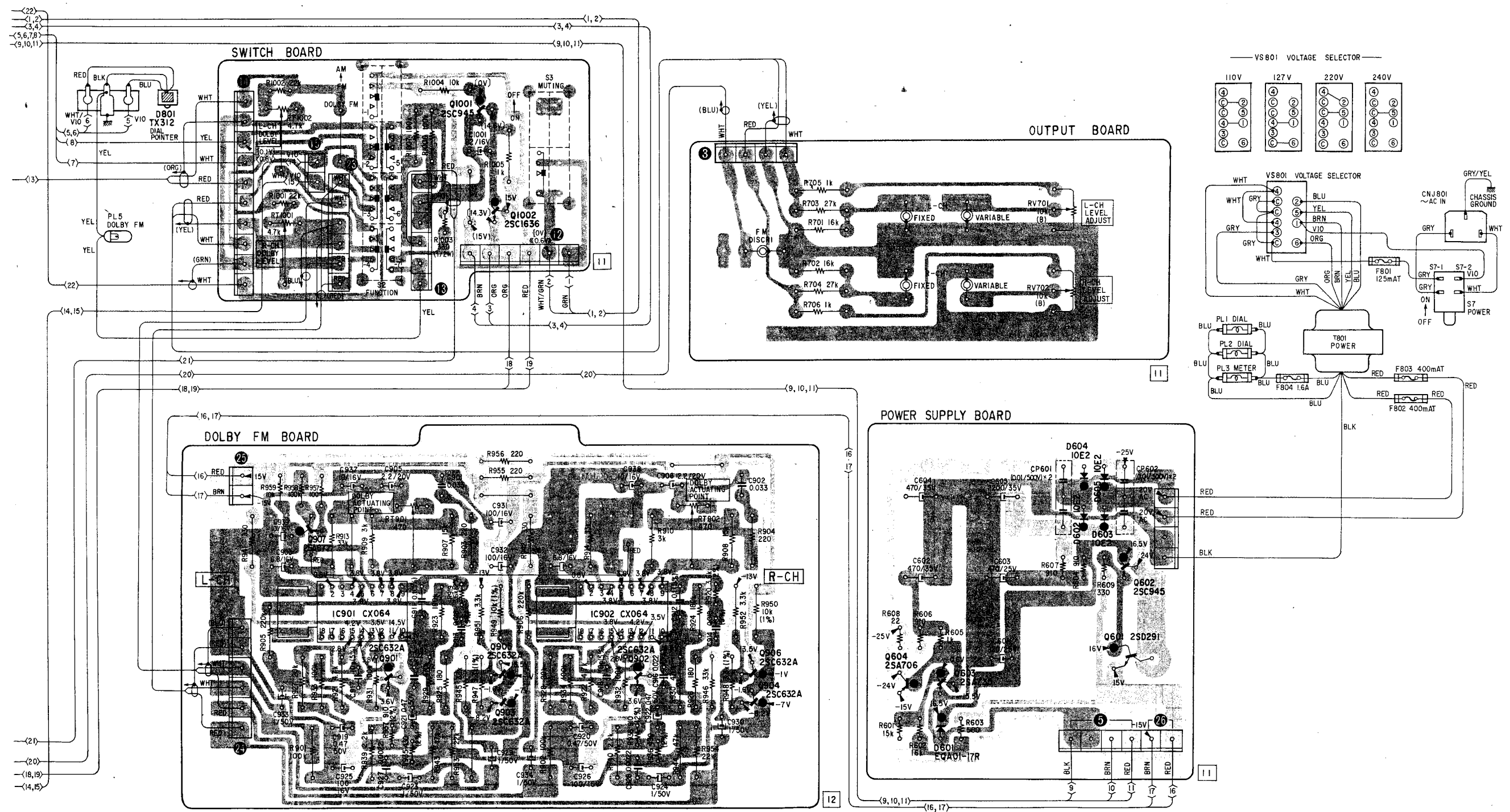

Q	907	IC901	901	1001	1002	IC902	902	906	604	603	602	Q
IC				905,903				904			601	IC
D	801								601		604 605 602 603	D

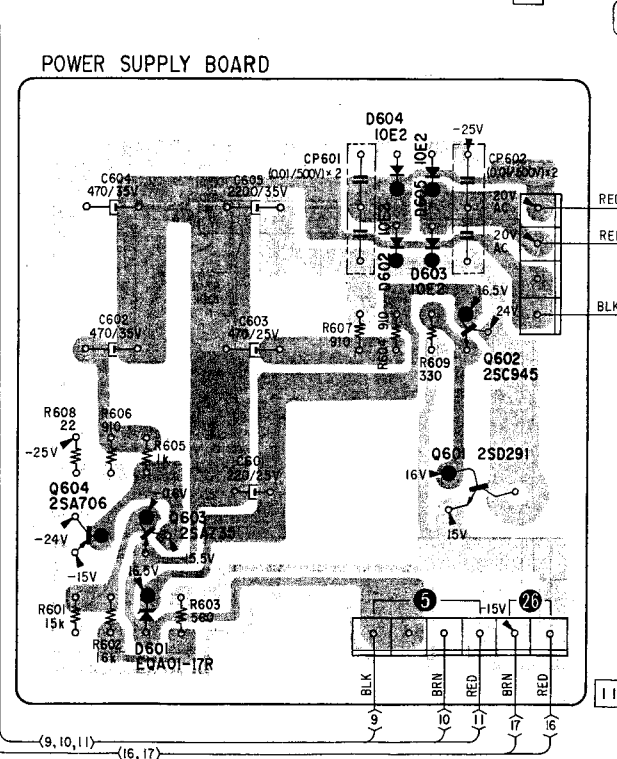
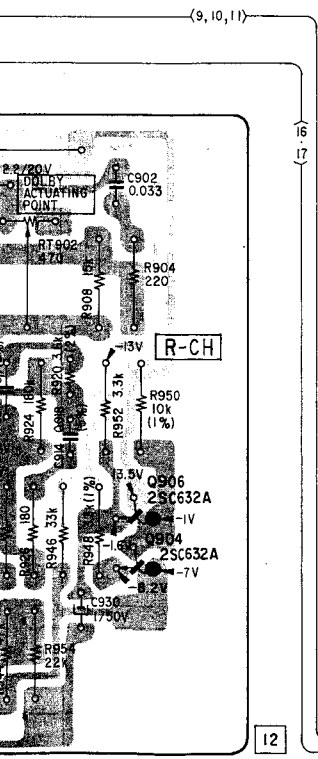
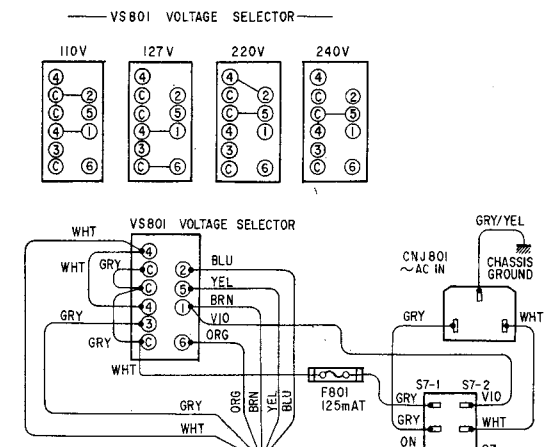
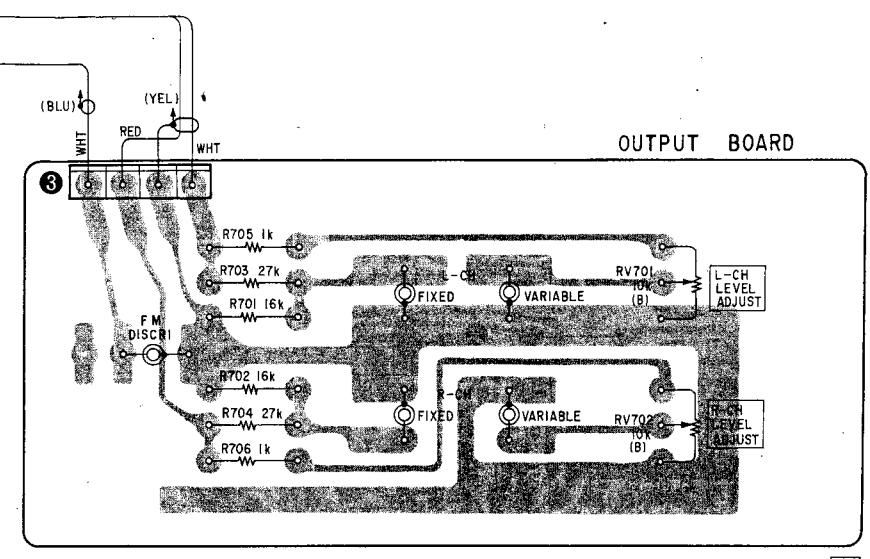

906	604	603	602	Q
904			601	IC
			604 605	
	601		602 603	D

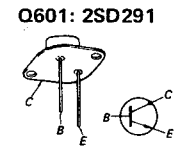
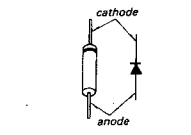
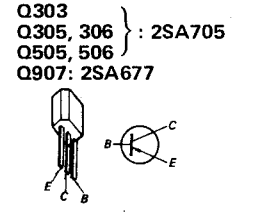
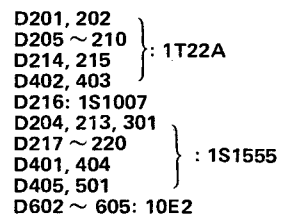
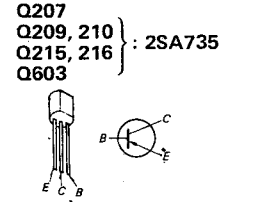
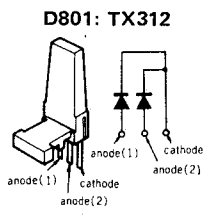
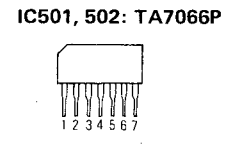
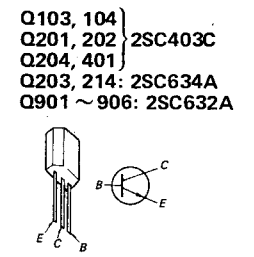
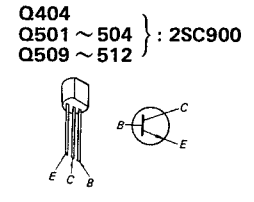
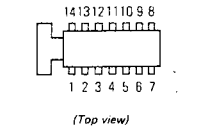
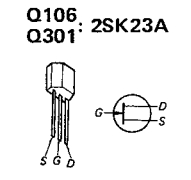
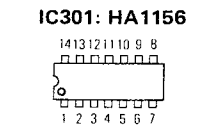
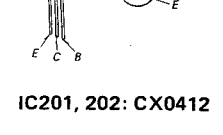
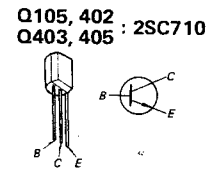
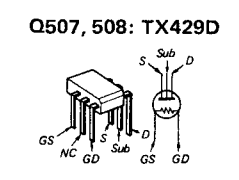
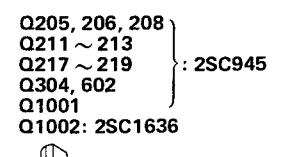
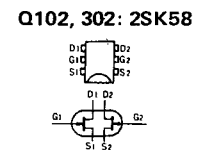
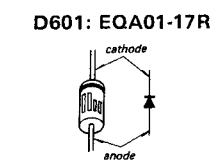
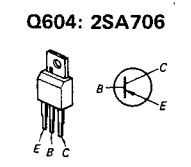
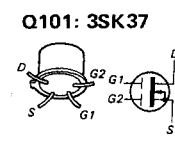

Note:

- Color in () indicates color of sleeving over the end portion of shielded wire.
- : B+ pattern
- : B- pattern

SECTION 5
EXPLODED VIEWS

(1)

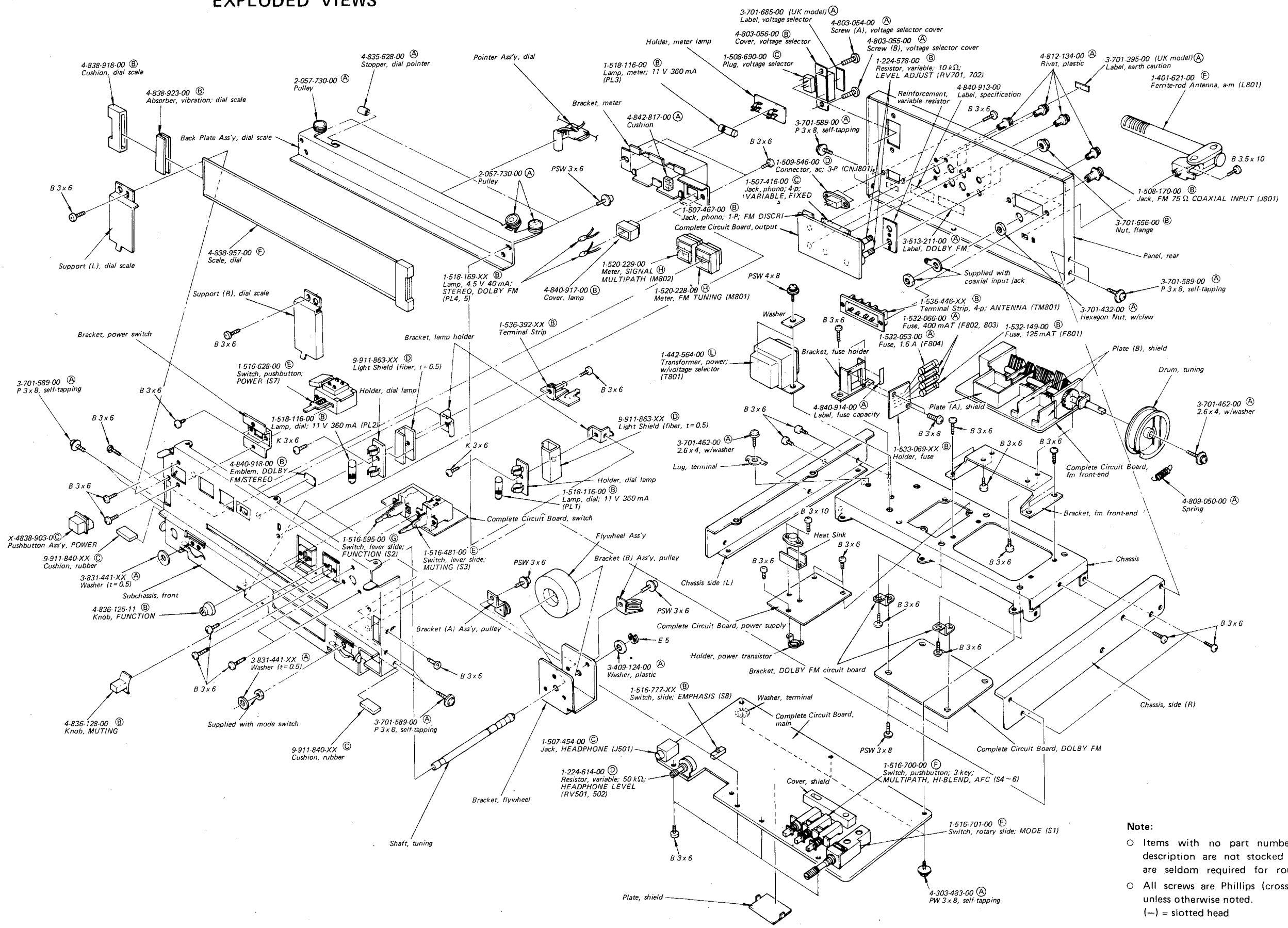

Note:

- Items with no part number and/or no description are not stocked because they are seldom required for routine service.
- All screws are Phillips (cross recess) type unless otherwise noted.
- (-) = slotted head

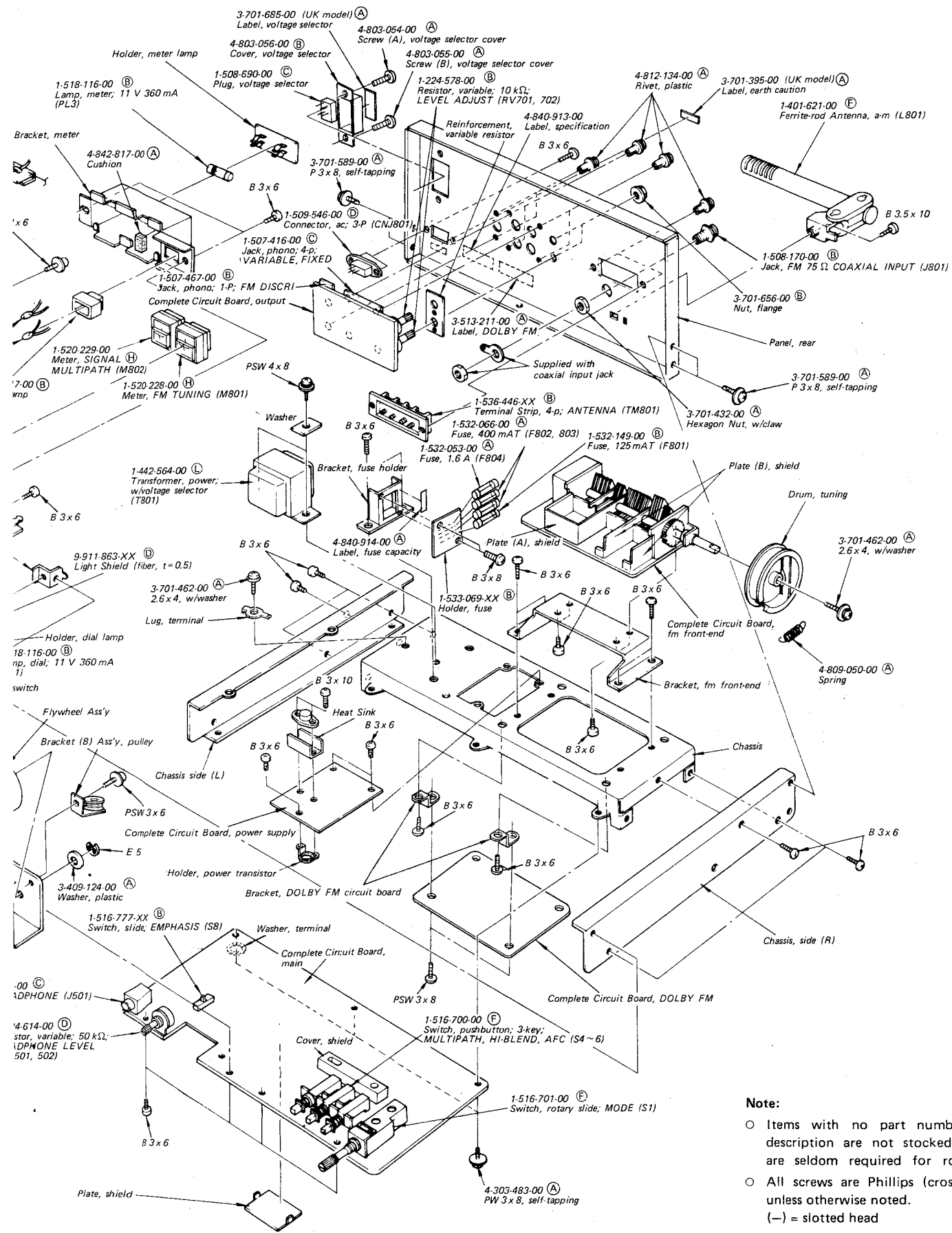

Note:

- Items with no part number and/or no description are not stocked because they are seldom required for routine service.
- All screws are Phillips (cross recess) type unless otherwise noted.
- (-) = slotted head

(2)

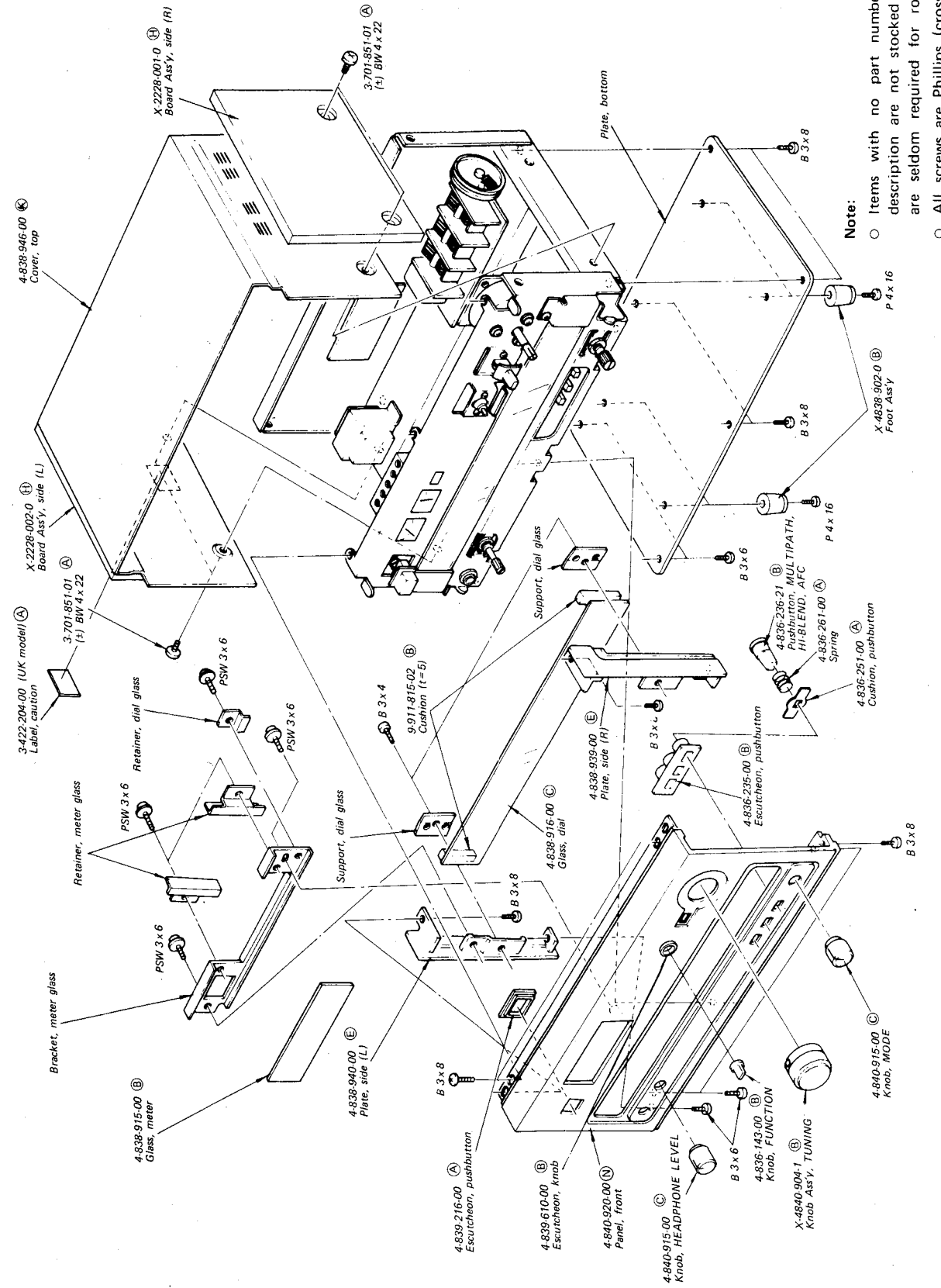

Note:

- Items with no part number and/or no description are not stocked because they are seldom required for routine service.
- All screws are Phillips (cross recess) type unless otherwise noted.
- (-) = slotted head

SECTION 6
ELECTRICAL PARTS LIST

Ref. No.	Part No.	Description	Ref. No.	Part No.	Description	Ref. No.	Part No.	Description	Ref. No.	Part No.	Description	Ref. No.				
SEMICONDUCTORS			ICs			TRANSFORMERS			CAPACITORS							
Transistors			Diodes			All capacitors are in μF and of ceramic unless otherwise noted. (p = μF, elect = electrolytic) 50 or less working volts are omitted except for electrolytic type.			COILS							
Q101	(E) 3SK37		IC201, 202	(F) CX0412		C101	1-102-668-11	(A) 15 p	L101	1-401-646-00	(B) FM Antenna	C201	1-102-978-11	(A) 220 p	C301	
Q102	(F) 2SK58		IC301	(J) HA1156		C102	1-102-257-11	(A) 2200 p	L102	1-425-902-00	(B) FM RF	C202	1-101-919-11	(A) 0.0022	C302, 3	
Q103, 104	(B) 2SC403C		IC501, 502	(D) TA7066P		C103	1-102-668-11	(A) 15 p	L103	1-425-903-00	(B) FM RF	C203	1-101-924-11	(A) 0.022	C304	
Q105	(B) 2SC710		IC901, 902	(I) CX064		C104, 105	1-102-257-11	(A) 2200 p	L104	1-425-904-00	(B) FM RF	C204	1-101-919-11	(A) 0.0022	C305	
Q106	(C) 2SK23A					C106	1-102-668-11	(A) 15 p	L105	1-407-175-XX	(A) Microinductor, 330 μ H	C205~207	1-101-924-11	(A) 0.022	C306	
Q201, 202	(B) 2SC403C					C107	1-101-924-11	(A) 0.022	L106	1-404-003-00	(B) FM IFT	C208	1-102-978-11	(A) 220 p	C307	
Q203	(B) 2SC634A					C108, 109	1-102-848-11	(A) 180 p	L107~110	1-407-175-XX	(A) Microinductor, 330 μ H	C209, 210	1-101-919-11	(A) 0.0022	C308	
Q204	(B) 2SC403C					C110	1-101-924-11	(A) 0.022	L111, 112	1-407-182-XX	(A) Microinductor, 2.2 μ H	C211	1-121-391-11	(A) 1 50 V	elect	C309
Q205, 206	(B) 2SC945					C111	1-101-919-11	(A) 0.0022				C212	1-101-924-11	(A) 0.022		
Q207	(C) 2SA735					C112, 113	1-101-924-11	(A) 0.022				C215	1-121-391-11	(A) 1 50 V	elect	C310
Q208	(B) 2SC945					C114	1-101-919-11	(A) 0.0022				C216, 217	1-121-398-11	(A) 10 25 V	elect	C311, 2
Q209, 210	(C) 2SA735					C115, 116	1-101-924-11	(A) 0.022				C218	1-101-924-11	(A) 0.022		C313
Q211~213	(B) 2SC945					C117, 118	1-102-663-11	(A) 8 p				C219, 220	1-121-726-11	(A) 0.47 50 V	elect	C314, 5
Q214	(B) 2SC634A					C119	1-102-668-11	(A) 15 p				C221	1-101-924-11	(A) 0.022		C316~
Q215, 216	(C) 2SA735					C120	1-101-924-11	(A) 0.022				C222	1-101-919-11	(A) 0.0022		C401, 6
Q217~219	(B) 2SC945											C223	1-101-924-11	(A) 0.022		C403
Q301	(C) 2SK23A											C224	1-121-391-11	(A) 1 50 V	elect	C404
Q302	(F) 2SK58											C225	1-121-352-11	(A) 47 10 V	elect	C405
Q303	(B) 2SA705											C226	1-121-391-11	(A) 1 50 V	elect	C406
Q304	(B) 2SC945											C227	1-121-398-11	(A) 10 25 V	elect	C407
Q305, 306	(B) 2SA705											C228	1-101-919-11	(A) 0.0022		C408
Q401	(B) 2SC403C											C229	1-101-924-11	(A) 0.022		C409
Q402, 403	(B) 2SC710											C230	1-121-395-11	(A) 4.7 25 V	elect	C410
⇒ Q404	(B) 2SC632A											C231	1-105-677-12	(A) 0.022	mylar	C411
Q405	(B) 2SC710											C232	1-105-679-12	(A) 0.033	mylar	C412, 3
⇒ Q501~504	(B) 2SC632A											C233	1-121-398-11	(A) 10 25 V	elect	C413
Q505, 506	(B) 2SA705											C234	1-121-404-11	(A) 33 25 V	elect	C414
Q507, 508	(F) TX429D											C235	1-105-685-12	(A) 0.1	mylar	C415
⇒ Q509~512	(B) 2SC632A											C236	1-105-681-12	(A) 0.047	mylar	C416
Q601	(D) 2SD291											C237	1-105-670-12	(A) 0.0056	mylar	C417
Q602	(B) 2SC945											C238	1-105-665-12	(A) 0.0022	mylar	C418
Q603	(C) 2SA735											C239	1-102-977-11	(A) 200 p		C419
Q604	(D) 2SA706											C240	1-101-880-11	(A) 47 p		C420
Q901~906	(B) 2SC632A											C241	1-121-391-11	(A) 1 50 V	elect	C421
⇒ Q907	(C) 2SA678											C243~246	1-101-924-11	(A) 0.022		C422
Q1001	(B) 2SC945											C247	1-121-413-11	(A) 100 6.3 V	elect	C423
Q1002	(B) 2SC1636											C248	1-101-924-11	(A) 0.022		C424

⇒ Due to replacement parts, the values are different from the diagrams.

Ref. No.	Part No.	Description
L201, 202	1-407-169-XX	(A) Microinductor, 100 μ H
L203	1-407-175-XX	(A) Microinductor, 330 μ H
L401	1-407-169-XX	(A) Microinductor, 100 μ H
L402	1-405-656-00	(B) AM Osc
L801	1-401-621-00	(F) AM Ferrite-rod Antenna
TRANSFORMERS		
'B101	1-417-025-00	(A) Balun
B801	1-417-014-21	(A) Balun
IFT201	1-403-964-00	(C) Discriminator
IFT401	1-403-963-21	(E) AM IFT
IFT402	1-403-149-00	(B) Detector IFT
T801	1-442-564-00	(L) Power, w/voltage selector (VS801)
CAPACITORS		
All capacitors are in μ F and of ceramic unless otherwise noted. (p = μ F, elect = electrolytic) 50 or less working volts are omitted except for electrolytic type.		
C101	1-102-668-11	(A) 15 p
C102	1-102-257-11	(A) 2200 p
C103	1-102-668-11	(A) 15 p
C104, 105	1-102-257-11	(A) 2200 p
C106	1-102-668-11	(A) 15 p
C107	1-101-924-11	(A) 0.022
C108, 109	1-102-848-11	(A) 180 p
C110	1-101-924-11	(A) 0.022
C111	1-101-919-11	(A) 0.0022
C112, 113	1-101-924-11	(A) 0.022
C114	1-101-919-11	(A) 0.0022
C115, 116	1-101-924-11	(A) 0.022
C117, 118	1-102-663-11	(A) 8 p
C119	1-102-668-11	(A) 15 p
C120	1-101-924-11	(A) 0.022

Ref. No.	Part No.	Description
C201	1-102-978-11	(A) 220 p
C202	1-101-919-11	(A) 0.0022
C203	1-101-924-11	(A) 0.022
C204	1-101-919-11	(A) 0.0022
C205~207	1-101-924-11	(A) 0.022
C208	1-102-978-11	(A) 220 p
C209, 210	1-101-919-11	(A) 0.0022
C211	1-121-391-11	(A) 1 50 V elect
C212	1-101-924-11	(A) 0.022
C215	1-121-391-11	(A) 1 50 V elect
C216, 217	1-121-398-11	(A) 10 25 V elect
C218	1-101-924-11	(A) 0.022
C219, 220	1-121-726-11	(A) 0.47 50 V elect
C221	1-101-924-11	(A) 0.022
C222	1-101-919-11	(A) 0.0022
C223	1-101-924-11	(A) 0.022
C224	1-121-391-11	(A) 1 50 V elect
C225	1-121-352-11	(A) 47 10 V elect
C226	1-121-391-11	(A) 1 50 V elect
C227	1-121-398-11	(A) 10 25 V elect
C228	1-101-919-11	(A) 0.0022
C229	1-101-924-11	(A) 0.022
C230	1-121-395-11	(A) 4.7 25 V elect
C231	1-105-677-12	(A) 0.022 mylar
C232	1-105-679-12	(A) 0.033 mylar
C233	1-121-398-11	(A) 10 25 V elect
C234	1-121-404-11	(A) 33 25 V elect
C235	1-105-685-12	(A) 0.1 mylar
C236	1-105-681-12	(A) 0.047 mylar
C237	1-105-670-12	(A) 0.0056 mylar
C238	1-105-665-12	(A) 0.0022 mylar
C239	1-102-977-11	(A) 200 p
C240	1-101-880-11	(A) 47 p
C241	1-121-391-11	(A) 1 50 V elect
C243~246	1-101-924-11	(A) 0.022
C247	1-121-413-11	(A) 100 6.3 V elect
C248	1-101-924-11	(A) 0.022

Ref. No.	Part No.	Description
C301	1-121-398-11	(A) 10 25 V elect
C302, 303	1-123-139-11	(A) 100 16 V elect
C304	1-102-973-11	(A) 100 p
C305	1-123-054-11	(B) 22 16 V elect
C306	1-103-717-11	(A) 470 p polystyrol
C307	1-105-681-12	(A) 0.047 mylar
C308	1-121-421-11	(B) 220 16 V elect
C309	1-127-373-11	(B) 0.1 16 V solid aluminum
C310	1-123-055-11	(A) 47 16 V elect
C311, 312	1-121-726-11	(A) 0.47 50 V elect
C313	1-121-421-11	(B) 220 16 V elect
C314, 315	1-108-571-12	(A) 0.0047 mylar
C316~319	1-108-572-12	(A) 0.0051 mylar
C401, 402	1-105-677-12	(A) 0.022 mylar
C403	1-105-679-12	(A) 0.033 mylar
C404	1-121-391-11	(A) 1 50 V elect
C409	1-101-924-11	(A) 0.022
C410	1-121-409-11	(A) 47 16 V elect
C411	1-105-677-12	(A) 0.022 mylar
C412, 413	1-101-924-11	(A) 0.022
C414	1-127-019-11	(A) 0.1 10 V solid aluminum elect
C415	1-121-391-11	(A) 1 50 V elect
C417	1-101-884-11	(A) 56 p
C418	1-101-924-11	(A) 0.022
C419	1-105-677-12	(A) 0.022 mylar
C420	1-105-679-12	(A) 0.033 mylar
C421	1-105-675-12	(A) 0.015 mylar
C422	1-121-413-11	(A) 100 6.3 V elect
C423	1-105-677-12	(A) 0.022 mylar
C424	1-121-391-11	(A) 1 50 V elect
C425	1-102-947-11	(A) 10 p
C426	1-105-677-12	(A) 0.022 mylar
C427	1-105-673-12	(A) 0.01 mylar
C428	1-105-677-12	(A) 0.022 mylar
C429	1-121-479-11	(A) 22 16 V elect

Ref. No.	Part No.	Description
C430	1-105-677-12	(A) 0.022 mylar
C431	1-121-378-11	(A) 10 25 V elect
C501, 502	1-123-050-11	(B) 2.2 50 V elect
C503	1-101-884-11	(A) 56 p
C504, 505	1-121-479-11	(A) 22 16 V elect
C506	1-101-884-11	(A) 56 p
C507, 508	1-121-421-11	(B) 220 16 V elect
C509~512	1-121-913-11	(A) 3.3 25 V elect
C513	1-105-679-12	(A) 0.033 mylar
C514	1-121-421-11	(B) 220 16 V elect
C515, 516	1-121-912-11	(A) 1 50 V elect
C517	1-105-675-12	(A) 0.015 mylar
C518, 519	1-121-748-11	(A) 10 25 V elect
C520	1-121-915-11	(A) 4.7 25 V elect
C521, 522	1-121-479-11	(A) 22 16 V elect
C523	1-121-915-11	(A) 4.7 25 V elect
C524, 525	1-102-973-11	(A) 100 p
C526, 527	1-121-404-11	(A) 33 25 V elect
C528, 529	1-105-661-12	(A) 0.001 mylar
C530	1-121-421-11	(B) 220 16 V elect
C531, 532	1-105-669-12	(A) 0.0047 mylar
C533~535	1-121-421-11	(B) 220 16 V elect
C536, 537	1-102-959-11	(A) 22 p
C601	1-121-936-11	(B) 220 25 V elect
C602	1-121-941-11	(B) 470 35 V elect
C603	1-121-940-11	(B) 470 25 V elect
C604	1-121-941-11	(B) 470 35 V elect
C605	1-121-984-11	(D) 2200 35 V elect
C901, 902	1-108-244-12	(A) 0.033 mylar
C903, 904	1-131-198-11	(B) 6.8 16 V tantalum
⇒C905, 906	1-131-205-11	(B) 2.2 25 V tantalum
C911, 912	1-108-816-12	(A) 0.1 mylar
C913, 914	1-108-807-12	(A) 0.018 mylar
C915, 916	1-108-808-12	(A) 0.022 mylar
C917, 918	1-102-947-11	(A) 10 p
C919~922	1-121-911-11	(A) 0.47 50 V elect

<u>Ref. No.</u>	<u>Part No.</u>	<u>Description</u>		
C923, 924	1-121-912-11	(A) 1	50 V	elect
C925, 926	1-121-415-11	(A) 100	16 V	elect
C927, 928	1-108-230-12	(A) 0.0022		mylar
C929, 930	1-121-912-11	(A) 1	50 V	elect
C931, 932	1-121-415-11	(A) 100	16 V	elect
C933, 934	1-121-912-11	(A) 1	50 V	elect
C937 ~ 939	1-121-916-11	(B) 10	16 V	elect
C1001	1-121-479-11	(A) 22	16 V	elect
C1250	1-121-404-11	(A) 33	25 V	elect
CT105	1-141-138-XX	(A) Trimmer		
CT401, 402	1-141-147-00	(A) Trimmer		

RESISTORS

All resistors are in ohms. Regular-type ¼ W, carbon resistors are omitted.

Check schematic diagram for resistance values. k = 1000

R320, 322	1-211-921-11	(A) 47 k	¼ W	±1%	carbon
R323, 326	1-210-504-11	(A) 3.9 k	¼ W	±1%	carbon
R327, 330	1-211-926-11	(A) 5.1 k	¼ W	±1%	carbon
R331	1-202-559-11	(A) 270	½ W	±5%	composition
R919, 920	1-210-871-11	(A) 3.6 k	¼ W	±2%	carbon
R935, 936	1-210-873-11	(A) 430	¼ W	±2%	carbon
R937, 938	1-210-851-11	(A) 910	¼ W	±2%	carbon
R947, 948	1-210-503-11	(A) 3.3 k	¼ W	±1%	carbon
R949, 950	1-210-506-11	(A) 10 k	¼ W	±1%	carbon
R1003	1-202-561-11	(A) 330	½ W	±5%	composition
RT201	1-224-648-XX	(B) 100 k, adjustable			
RT202	1-224-644-XX	(B) 4.7 k, adjustable			
RT203	1-224-641-XX	(B) 470, adjustable			
RT301	1-224-645-XX	(B) 10 k, adjustable			
RT501, 502	1-224-648-XX	(B) 100 k, adjustable			
RT503, 504	1-224-644-XX	(B) 4.7 k, adjustable			
RT901, 902	1-224-641-XX	(B) 470, adjustable			

<u>Ref. No.</u>	<u>Part No.</u>	<u>Description</u>		
RT1001				
RT1002	1-224-644-XX	(B) 4.7 k, adjustable		
RV501, 502	1-224-614-00	(D) 50 k, variable; HEADPHONE LEVEL		
RV701, 702	1-224-578-00	(B) 10 k, variable; LEVEL ADJUST		

SWITCHES

S1	1-516-701-00	(F) Rotary Slide, MODE
S2	1-516-595-00	(G) Lever Slide, FUNCTION
S3	1-516-481-00	(E) Lever Slide, MUTING
S4 ~ 6	1-516-700-00	(F) Pushbutton, 3-key; MULTIPATH, HI-BLEND, AFC
S7	1-516-628-00	(E) Pushbutton, POWER
S8	1-516-777-XX	(B) Slide, EMPHASIS

FUSES

F801	1-532-149-00	(B) 125 mA T
F802, 803	1-532-066-00	(A) 400 mA T
F804	1-532-053-00	(A) 1.6 A

JACKS

J501	1-507-454-00	(C) HEADPHONE
J801	1-508-170-00	(B) FM 75 Ω COAXIAL INPUT
	1-507-416-00	(C) Phono, 4-p, VARIABLE/FIXED
	1-507-467-00	(B) Phono, 1-p; FM DISCRI

MISCELLANEOUS

CNJ801	1-509-546-00	(D) Connector, ac; 3-p
CF201, 202	1-527-248-94	(H) Filter, ceramic; 10.7 MHz
CP201	1-231-278-00	(B) Encapsulated Component
CP601, 602	1-102-355-00	(A) Capacitor, ceramic; (0.01 μF 500 V) x 2
LPI501	1-231-292-00	(J) Filter, low-pass

ST-5950SD

<u>Ref. No.</u>	<u>Part No.</u>	<u>Description</u>
M801	1-520-228-00	(H) Meter, FM TUNING
M802	1-520-229-00	(H) Meter, SIGNAL MULTIPATH
PL1 ~3	1-518-116-00	(B) Lamp, 11 V 360 mA; dial. meter
PL4, 5	1-518-169-XX	(B) Lamp, 4.5 V 40 mA; STEREO, DOLBY FM
TM801	1-536-446-XX	(B) Terminal Strip; 4-p; ANTENNA
	1-508-690-00	(C) Plug, voltage selector
	1-533-069-XX	(B) Holder, fuse
	1-536-392-XX	(B) Terminal Strip

ACCESSORIES

<u>Part No.</u>	<u>Description</u>
X-4490-002-2	(A) Cloth Ass'y, polishing
1-502-083-21	(D) Ribbon Antenna, fm
1-506-305-12	(C) Plug, coaxial input jack; FP-33
1-534-049-31	(D) Cord, connection; RK-74
1-534-819-00	(G) Cord, power (UK Model)
3-780-883-11	(F) Manual, instruction