

ST-JX22L/22LB

For Service Manuals Contact
MAURITRON TECHNICAL SERVICES
 8 Cherry Tree Rd, Chinnor
 Oxon OX9 4QY
 Tel:- 01844-351694 Fax:- 01844-352554
 Email:- enquiries@mauritron.co.uk

ST-JX22L: SILVER TYPE

AEP Model
UK Model

ST-JX22LB: BLACK TYPE

AEP Model
UK Model

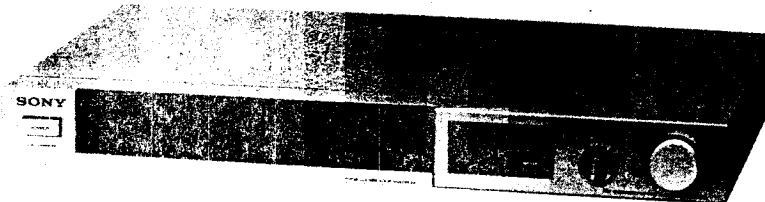

Photo: ST-JX22L

FM STEREO/FM-AM TUNER

SPECIFICATIONS

FM tuner section

Tuning range 87.5 MHz - 108 MHz
 Antenna terminals 300 ohms, balanced
 75 ohms, unbalanced
 Intermediate frequency 10.7 MHz

	(at 40 kHz deviation)
Sensitivity	at 46 dB quieting 17.3 dBf, 4 μ V (mono); 38.3 dBf, 45 μ V (stereo)
Usable sensitivity	10.3 dBf, 1.8 μ V (IHF) 1.7 μ V (S/N = 26 dB)
Signal-to-noise ratio	76 dB (mono) 71 dB (stereo)
Harmonic distortion (at 1 kHz)	0.15% (mono) 0.3% (stereo)
IM distortion	0.15% (mono) 0.3% (stereo)

Separation (at 1 kHz)	45 dB
Frequency response	40 Hz - 12.5 kHz ± 0.5 dB 30 Hz - 15 kHz $+0.5$ dB -2 dB
Selectivity	at 300 kHz 70 dB
Capture ratio	1.0 dB
AM suppression ratio	54 dB
Image response ratio	50 dB
IF response ratio	90 dB

Spurious response ratio	70 dB
RF intermodulation	60 dB (IHF)
Muting threshold	approx. 25.2 dBf, 10 μ V
Output level/ impedance	at 75 kHz deviation 750 mV, 2.7 k ohms

- Continued on page 2 -

SAFETY-RELATED COMPONENT WARNING!!

COMPONENTS IDENTIFIED BY SHADING AND MARK  ON THE SCHEMATIC DIAGRAMS, EXPLODED VIEWS AND IN THE PARTS LIST ARE CRITICAL TO SAFE OPERATION. REPLACE THESE COMPONENTS WITH SONY PARTS WHOSE PART NUMBERS APPEAR AS SHOWN IN THIS MANUAL OR IN SUPPLEMENTS PUBLISHED BY SONY.



SONY®

SERVICE MANUAL

MW/LW tuner section

		MW	LW
Tuning range		522 kHz - 1,602 kHz	153 kHz - 344 kHz
Antenna	ferrite-bar antenna	provided	provided
	external antenna terminal	provided	provided
Intermediate frequency		450 kHz	450 kHz
Usable sensitivity	ferrite-bar antenna	200 μ V/m (at 1,000 kHz)	400 μ V/m (at 230 kHz)
	external antenna	100 μ V (at 1,000 kHz)	50 μ V (at 230 kHz)
Signal-to-noise ratio		54 dB	54 dB
Harmonic distortion		0.3%	0.3%
Selectivity		35 dB (9 kHz)	35 dB (9 kHz)

General

System FM stereo, FM/AM superheterodyne tuner
 Power requirements (AEP) : 220 V ac
 (UK) : 240 V ac adjustable
 50/60 Hz
 Power consumption 8 watts
 Dimensions Approx. 430 x 55 x 310 mm (w/h/d)
 (17 x 2¹/₄ x 12¹/₄ inches)
 including projecting parts and controls
 Weight Approx. 2.6 kg (5 lbs 12 oz) net
 Approx. 3.1 kg (6 lbs 14 oz) in shipping carton

MODEL IDENTIFICATION

- Specification Label -

• ST-JX22L

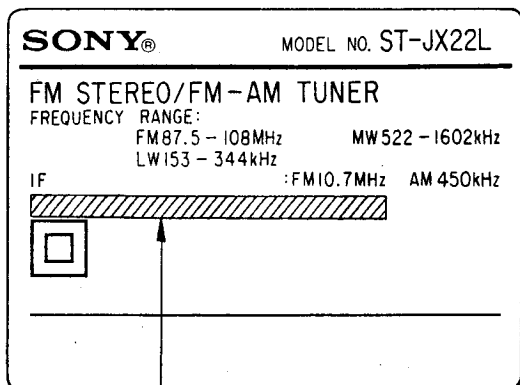

AEP model : 220 V ~ 50/60 Hz 8W
 UK model : 240 V ~ 50/60 Hz 8W

• ST-JX22LB

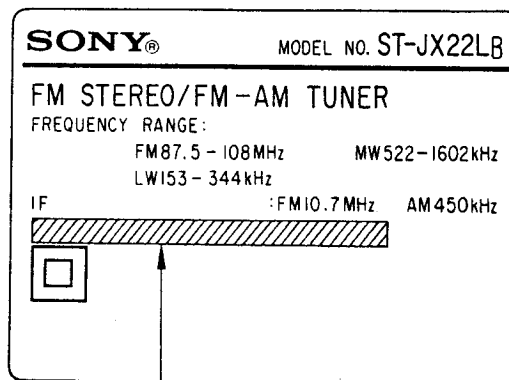

AEP model : 220 V ~ 50/60 Hz 8W
 UK model : 240 V ~ 50/60 Hz 8W

SECTION 1
OUTLINE

1-1. BLOCK DIAGRAM

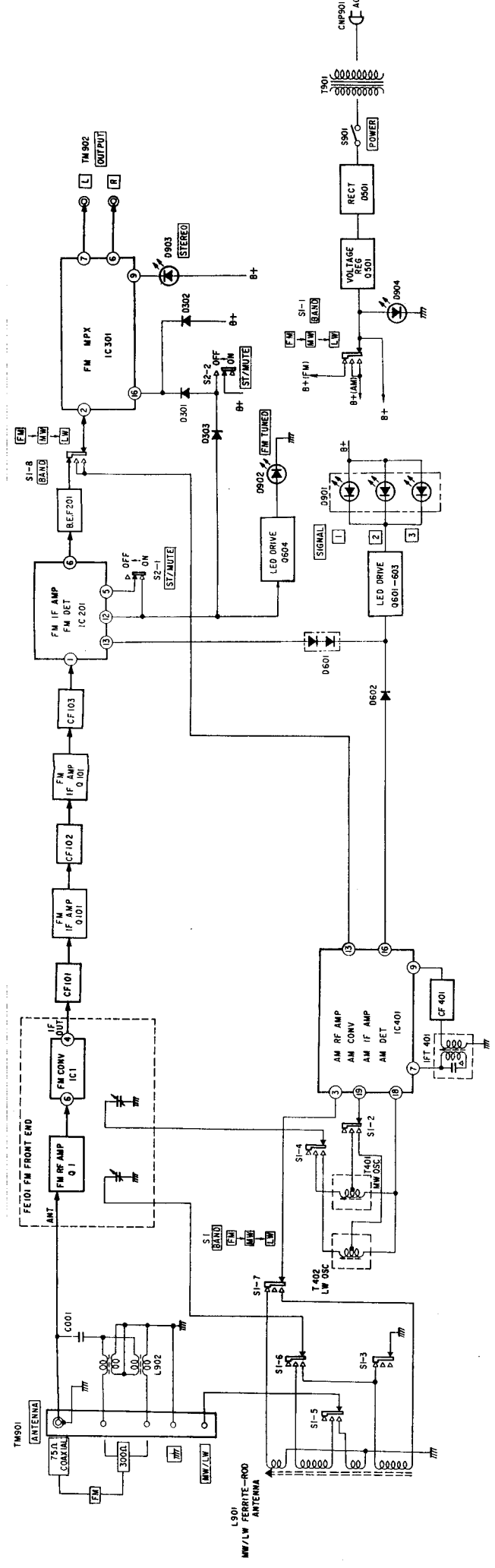

For Service Manuals Contact
MAURITRON TECHNICAL SERVICES
 8 Cherry Tree Rd, Chinnor
 Oxon OX9 4QY
 Tel:- 01844-351694 Fax:- 01844-352554
 Email:- enquiries@mauritron.co.uk

SECTION 2 DISASSEMBLY

2-1. REMOVAL

Note: Follow the disassembly procedure in the numerical order given.

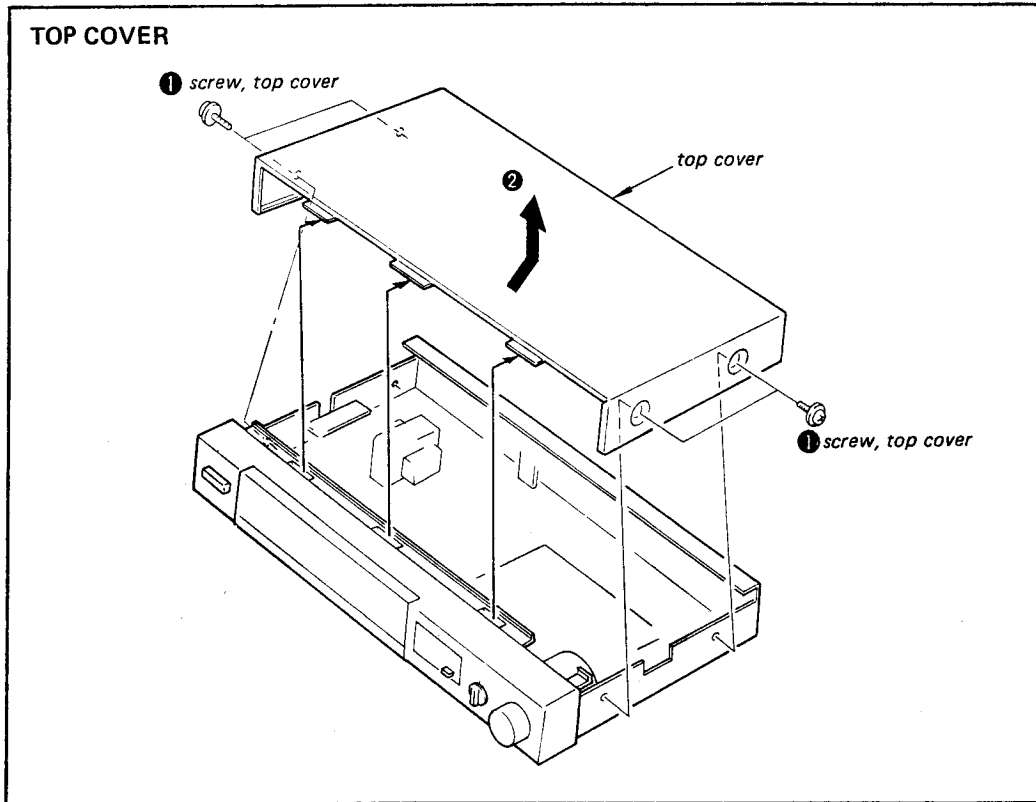

For Service Manuals Contact
MAURITRON TECHNICAL SERVICES
8 Cherry Tree Rd, Chinnor
Oxon OX9 4QY
Tel: 01844-351694 Fax: 01844-352554
Email: enquiries@mauritron.co.uk

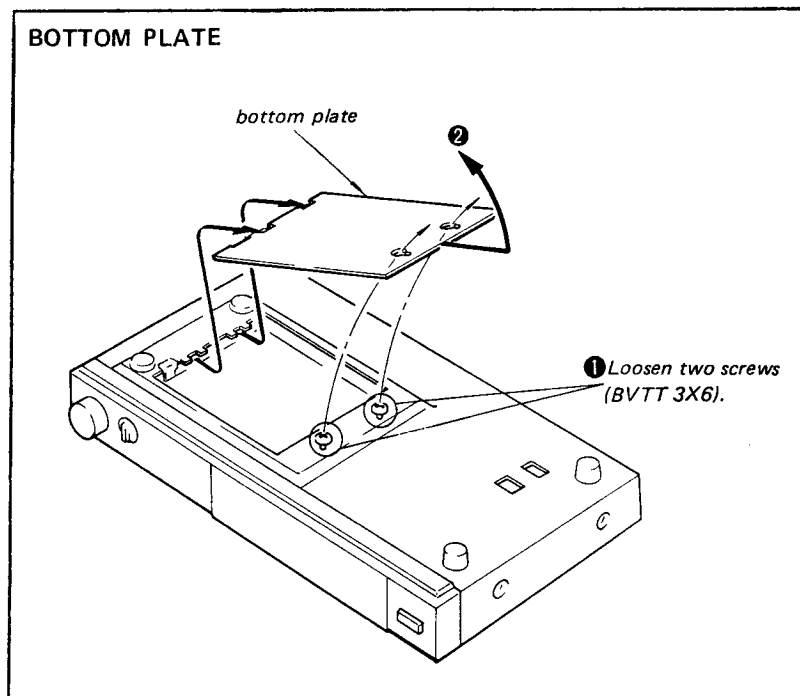

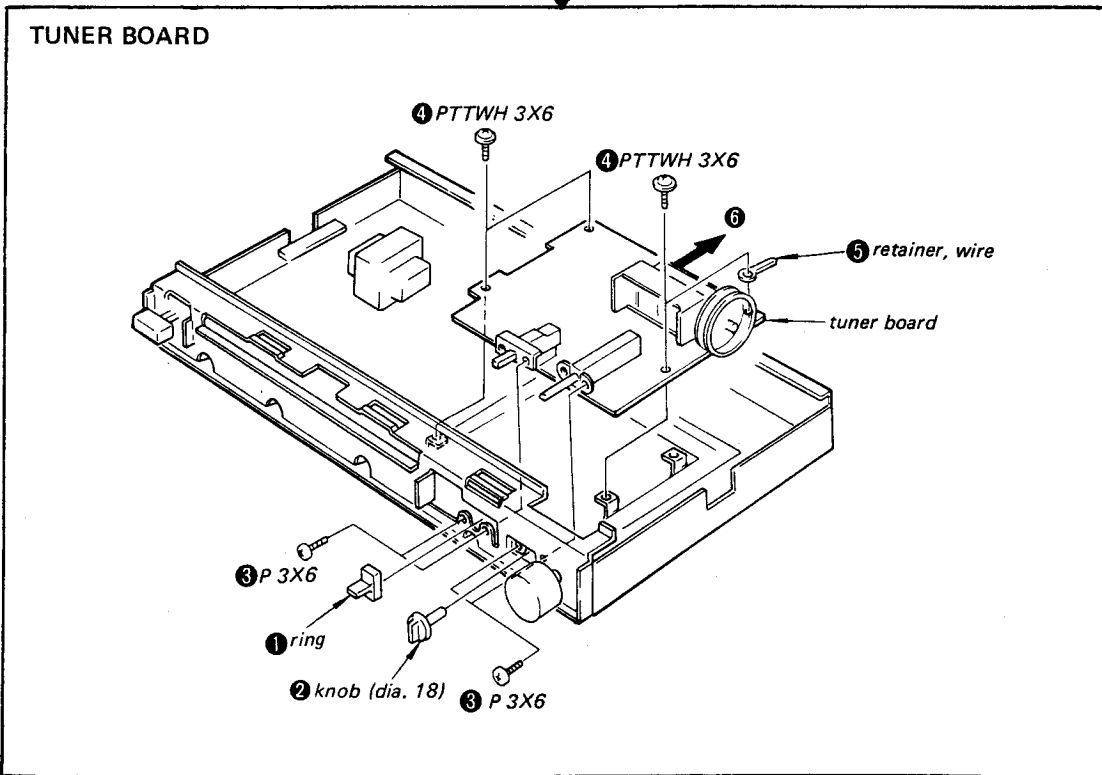
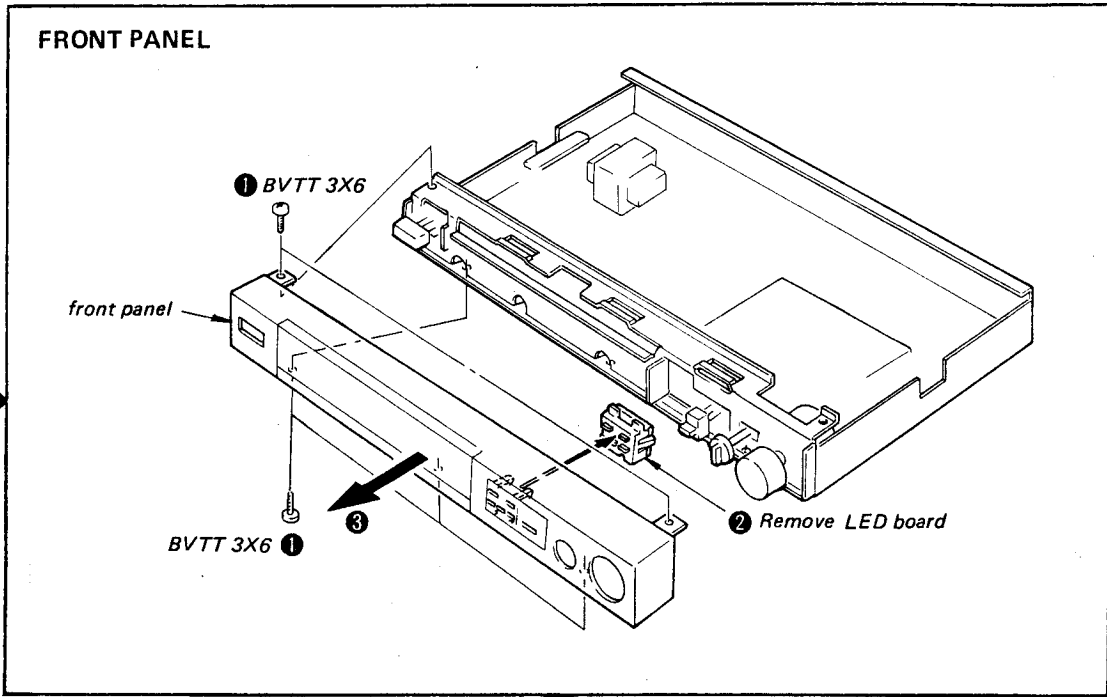

2-2. DIAL CORD STRINGING

1) Preparation

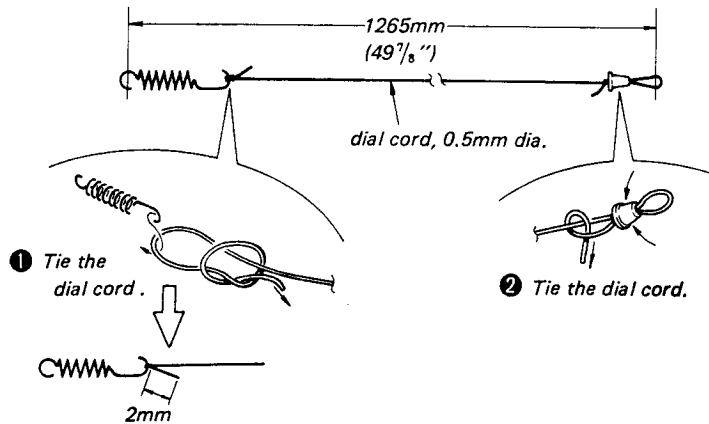

2) Stringing

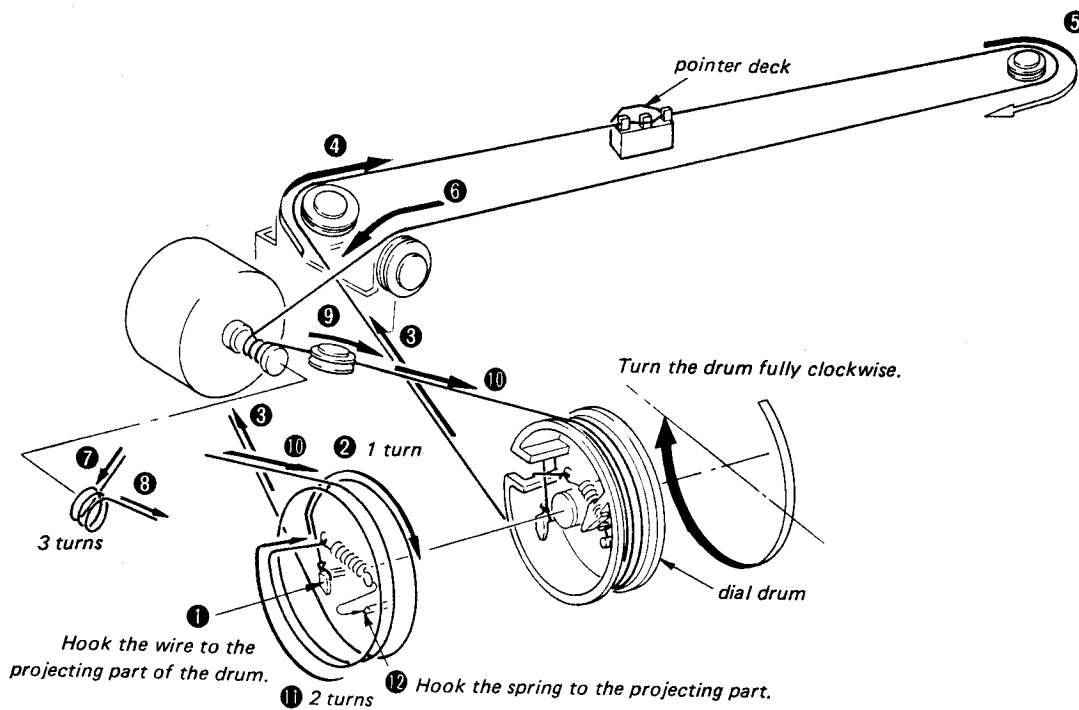

3) Dial Pointer Installation

1. Receive a broadcasting station signal and set the dial pointer on the dial scale.
2. Apply a drop of contact cement to the dial pointer.

For Service Manuals Contact
MAURITRON TECHNICAL SERVICES
 8 Cherry Tree Rd, Chinnor
 Oxon OX9 4QY
 Tel: 01844-351694 Fax: 01844-352554
 Email: enquiries@mauritron.co.uk

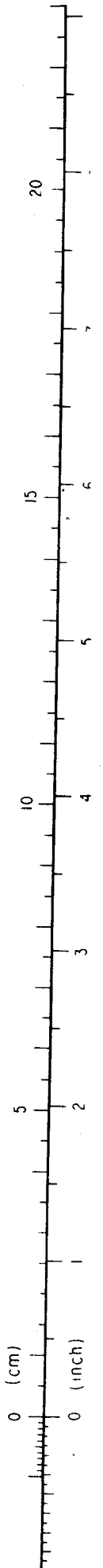

SECTION 3 ADJUSTMENTS

MW/LW SECTION

Setting:

Band Selector: MW
LW

Setup:

AM rf signal generator

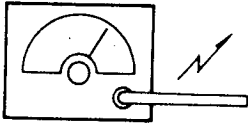

Put the lead-wire antenna close to the set.

VOM (A)
(range: 0.5-5V ac)

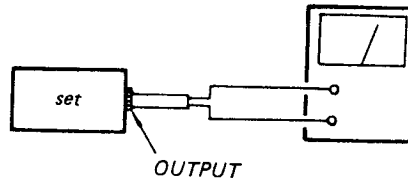

Carrier frequency: 1,000kHz (MW)
250kHz (LW)
30% amplitude modulation by 400 Hz signal

- Repeat the procedures in each adjustment several times, and the frequency coverage and tracking adjustments should be finally done by the trimmer capacitors.

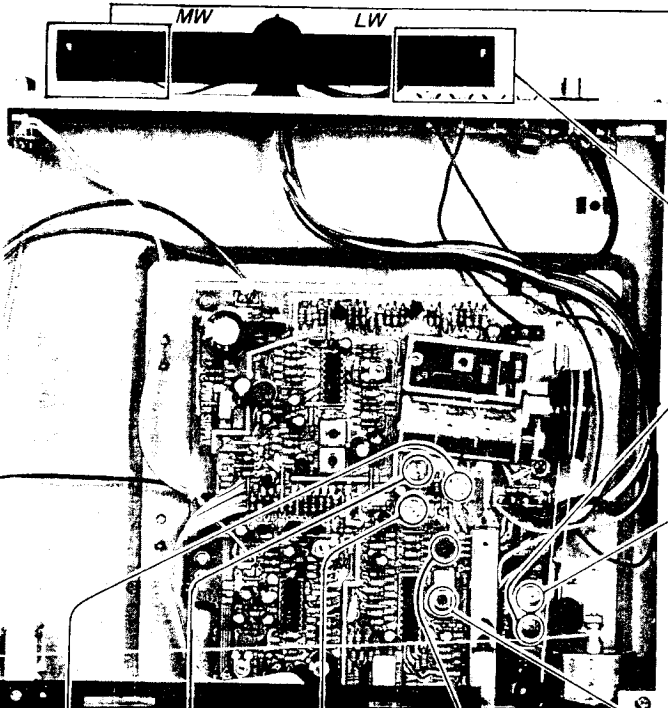

MW TRACKING ADJUSTMENT	
Adjust for a maximum reading on VOM (A) .	
L901	600kHz
CT404	1,400kHz

LW TRACKING ADJUSTMENT	
Adjust for a maximum reading on VOM (A) .	
L901	170kHz
CT403	310kHz

AM IF ADJUSTMENT	
Adjust for maximum reading on VOM (A) .	
IFT401	450 kHz

CT404	T402
1,660kHz	515kHz
Adjust for a maximum reading on VOM (A) .	
MW FREQUENCY COVERAGE ADJUSTMENT	

CT401	T402
365kHz	145kHz
Adjust for a maximum reading on VOM (A) .	
LW FREQUENCY COVERAGE ADJUSTMENT	

FM SECTION

FM Discriminator Alignment

Procedure:

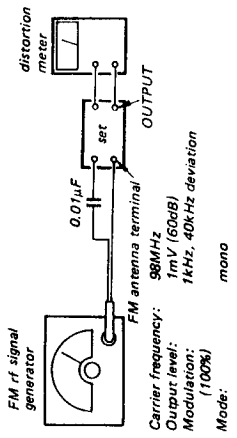

Carrier frequency: 98MHz
Output level: 1mV (60dB)
Modulation: 1kHz, 40kHz deviation (100%)
Mode: mono

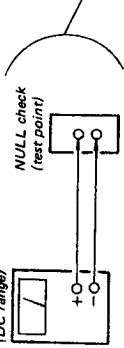

1. Tune the set to 98MHz.
2. Connect a VOM to NULL CHECK (test point) and adjust the primary-side core (red) of IFT201 for 0V DC reading on the VOM.
3. Adjust the secondary-side core (black) of IFT202 for a minimum reading on the distortion meter.

Note: Repeat the secondary-side and primary-side adjustments several times.

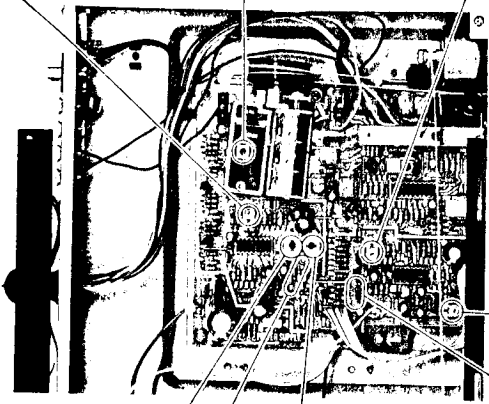

FM Muting Level Adjustment

Setting:

STEREO MUTING switch (S2): ON

Procedure:

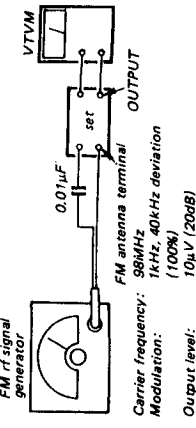

- Carrier frequency:** 98MHz
Modulation: 1kHz, 40kHz deviation (100%)
Output level: 10µV (20dB)
1. Tune the set to 98MHz.
 2. Set the output level of the FM rf signal generator to 20dB (10µV).
 3. Turn RT201 and stop it just when the VTMV indication suddenly decreases.

For Service Manuals Contact
MAURITRON TECHNICAL SERVICES
 8 Cherry Tree Rd, Chinnor
 Oxon OX9 4QY
 Tel: 01844-351694 Fax: 01844-352554
 Email: enquiries@mauritron.co.uk

IFT1

The FM front-end is carefully adjusted at the factory and is supplied as one whole block for replacement. In case of replacement, perform the following adjustments.

1. Front-End IFT Adjustment.

Setting:

STEREO MUTING switch (S2): OFF

Procedure:

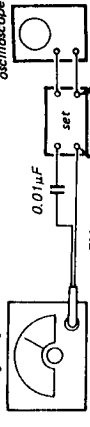

Carrier frequency: 98MHz
Modulation: 1kHz, 40kHz deviation (100%)
Output level: 2µV (60dB)

Adjust IFT1 so that the noise levels at the peak of the waveforms on the oscilloscope are symmetrical and the output level is maximum.

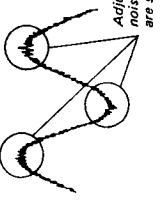

2. Dial Pointer Setting

(Refer to Dial Pointer Setting on page 7.)

3. MW Tuning Adjustment

(Refer to MW Tuning Adjustment on page 8.)

VCO Adjustment

A) Regular Method

Procedure:

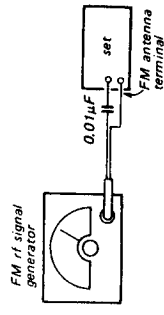

Carrier frequency: 98MHz
Modulation: no modulation
Output level: 1mV (60dB)

B) Simple Method

Procedure:

1. Tune the set to 98MHz.
2. Adjust RT301 for 19kHz ± 50Hz on the counter.

FM Stereo Separation Adjustment

Setting:

STEREO MUTING switch (S2): ON

Procedure:

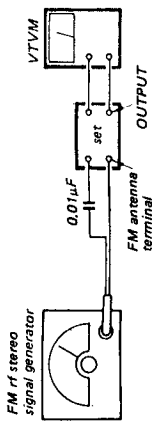

Carrier frequency: 98MHz
Output level: 1mV (60dB)
Mode: stereo
Modulation: Audio (1kHz): 16.25kHz deviation (40%)
 Pilot (19kHz): 7.5kHz deviation (20%)
 Sub-channel (38kHz): 16.25kHz deviation (40%)

FM stereo signal generator output channel	VTVM connection	VTVM reading (dB)
L-CH	L-CH	(A)
R-CH	L-CH	(B)
R-CH	R-CH	(C)
L-CH	R-CH	(D)

L-CH Stereo Separation: (A) - (B)
 R-CH Stereo Separation: (C) - (D)
 The separations of both channels should be equal.

VCO Adjustment

A) Regular Method

Procedure:



Carrier frequency: 98MHz
Modulation: no modulation
Output level: 1mV (60dB)

B) Simple Method

Procedure:

1. Tune the set to the FM stereo broadcasting signal.
2. Turn RT301 clockwise or counterclockwise and memorize the lighting-up range of the stereo lamp.
3. Secure RT301 at the center of the lighting-up range of both turns as shown below.

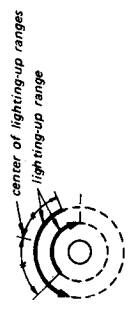

4.1. MOUNTING DIAGRAM
- Conductor Side -

SECTION 4
DIAGRAMS

A

B

C

D

• See page 13 for semiconductor lead layouts.

Q	IC	101	102	603	602	604	601
		IC401	IC201				IC301
D			201	601	602		501
			303				302 301

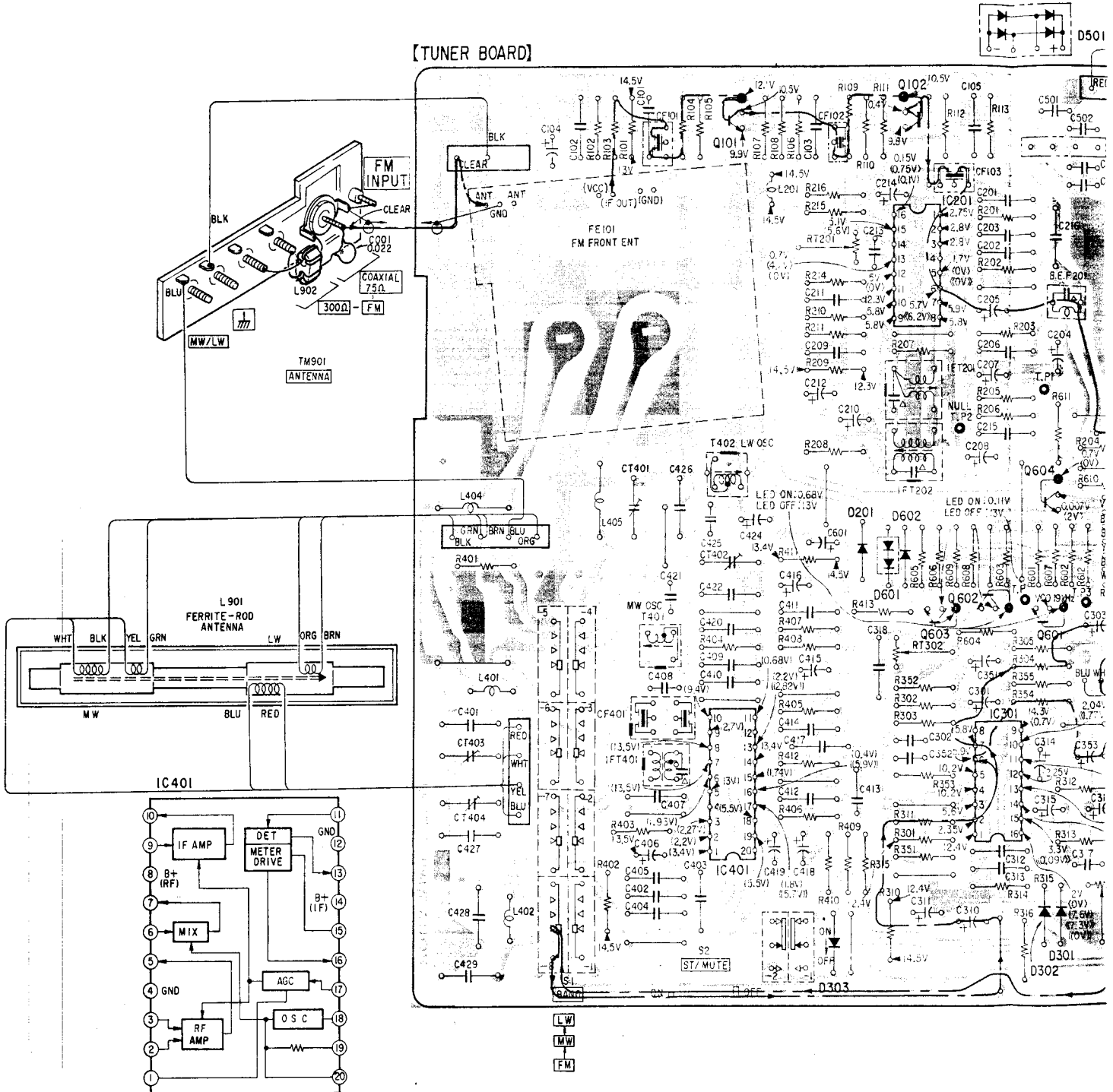

• Color code of sleeving over the end of the jacket.

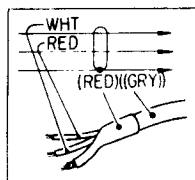

- ○ — : parts extracted from the component side.
- □ — : indicates side identified with part number.
- B+ pattern
- —> : signal path
- —> : L-CH signal path
- —> : R-CH signal path

For Service Manuals Contact
MAURITRON TECHNICAL SERVICES
8 Cherry Tree Rd, Chinnor
Oxon OX9 4QY
Tel: 01844-351694 Fax: 01844-352554
Email: enquiries@mauritron.co.uk

ST-JX22L/22LB ST-JX22L/22LB

C

D

E

F

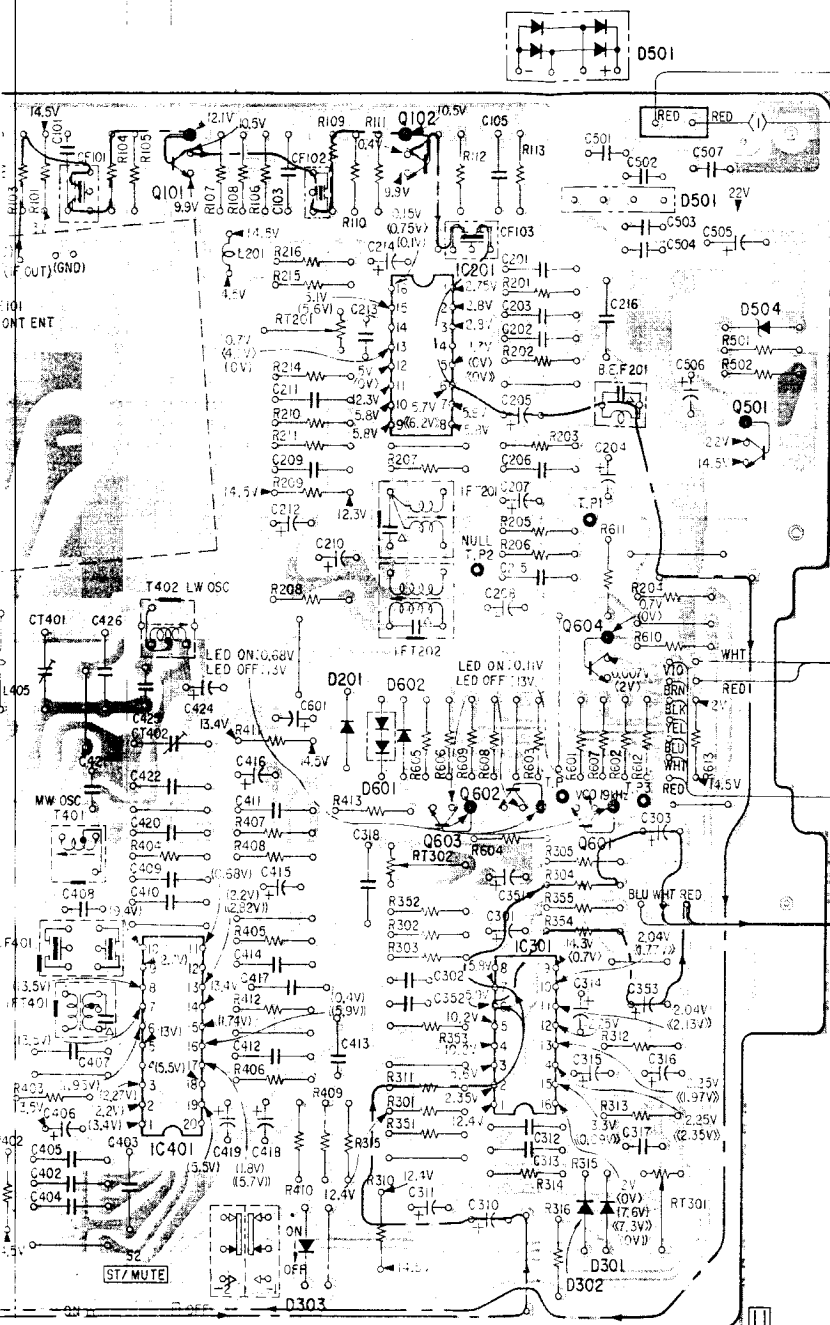
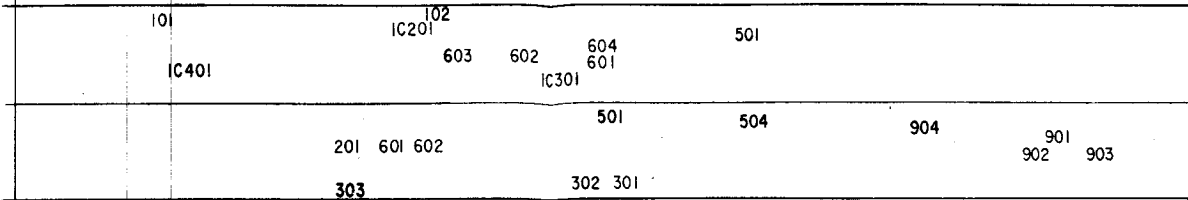

[POWER SWITCH BOARD]

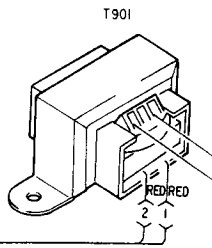
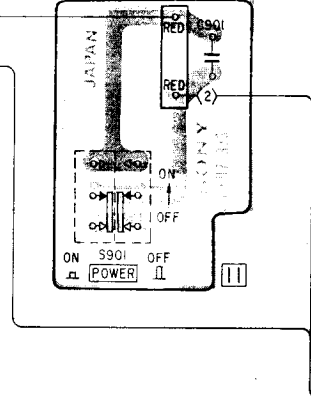

[POINTER BOARD]

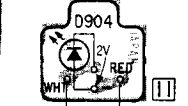

[LED BOARD]

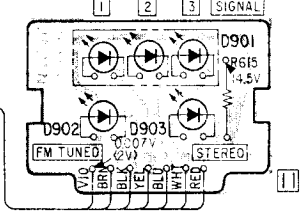

[OUT PUT BOARD]

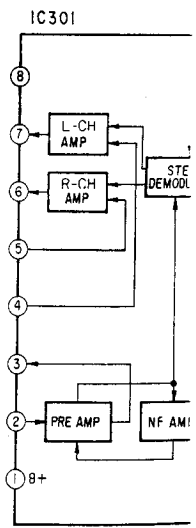
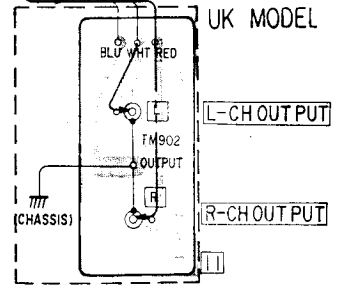

[OUTPUT BOARD]

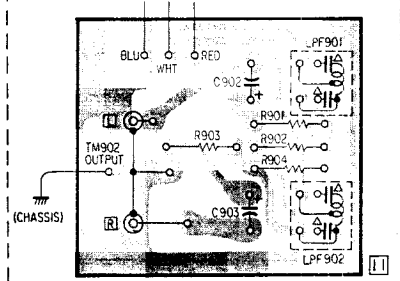

AEP MODEL

from the component side.
identified with part number.

- ———— : signal path
- ———— : L-CH signal path
- ———— : R-CH signal path

E F G H

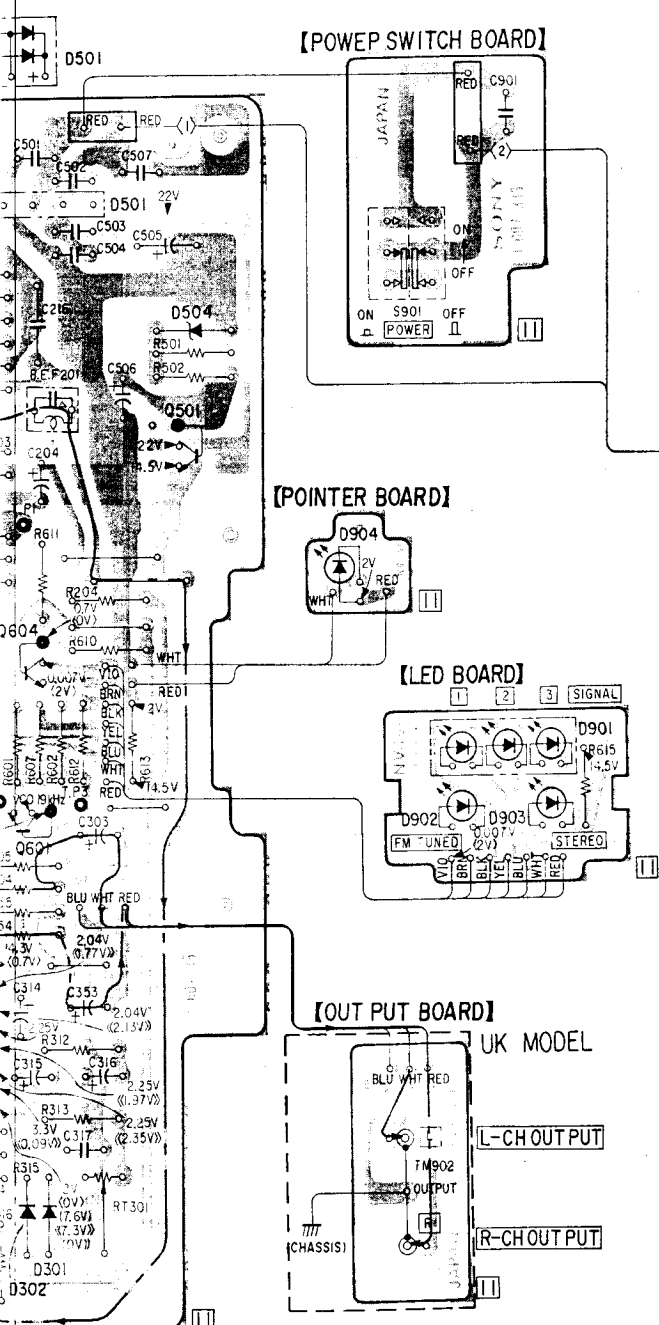
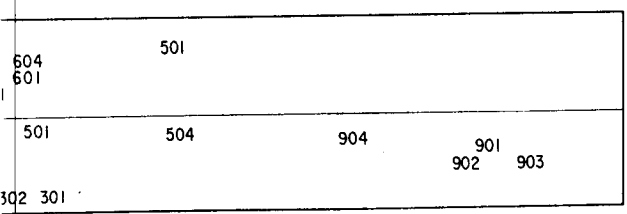

【POWER SWITCH BOARD】

【POINTER BOARD】

【LED BOARD】

【OUT PUT BOARD】

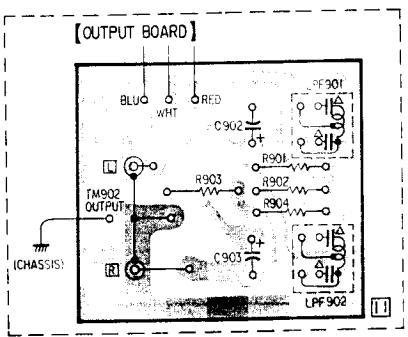
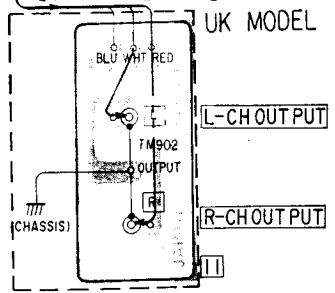

AEP MODEL

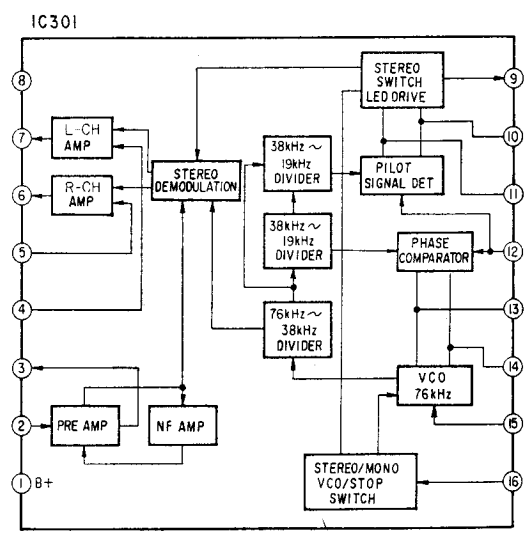
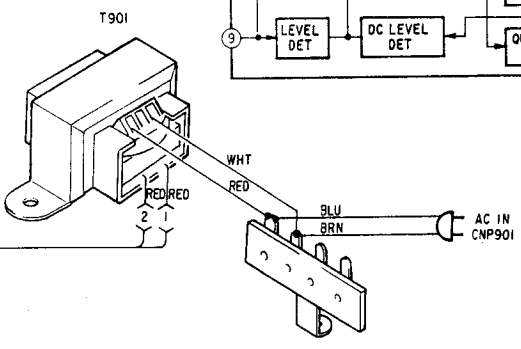
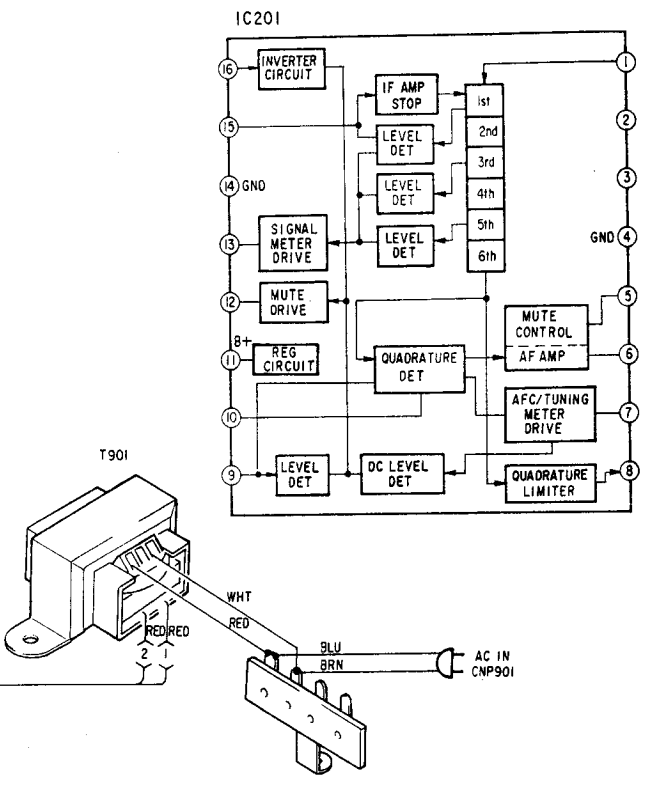

For Service Manuals Contact
MAURITRON TECHNICAL SERVICES
 8 Cherry Tree Rd, Chinnor
 Oxon OX9 4QY
 Tel: 01844-351694 Fax: 01844-352554
 Email: enquiries@mauritron.co.uk

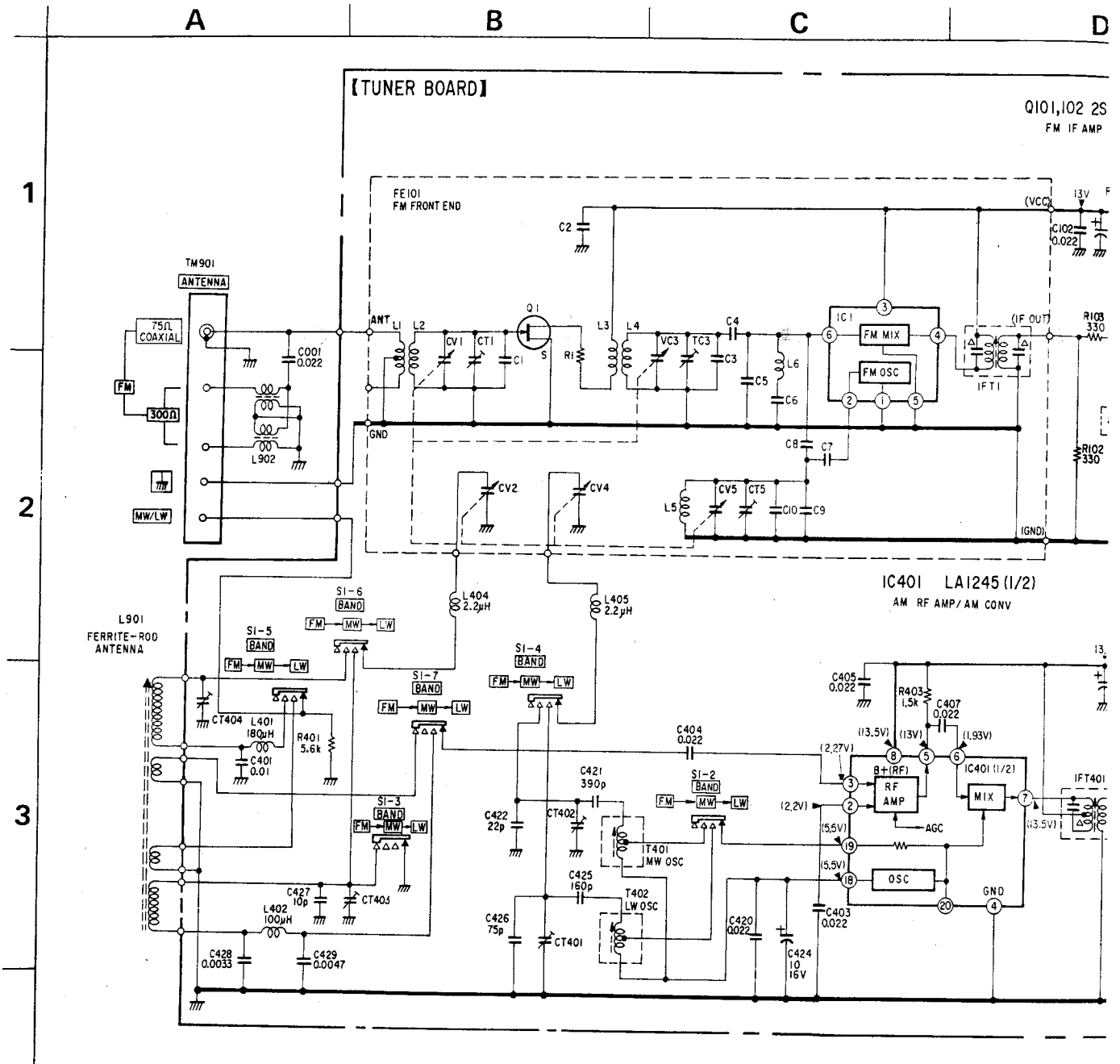

Semiconductor Lead Layouts

LA1231, μPC1235C

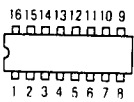

LA1245

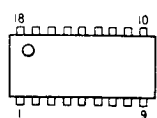

ZSC710-15



2SD809

letter side

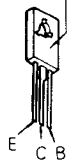

2SC1364



SLP251D
SLP252D-03

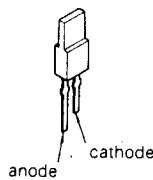

SLP151D

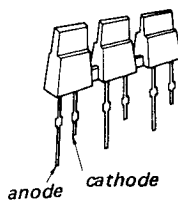

1S1555
EQB01-15

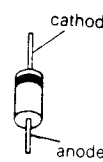

SIVB20

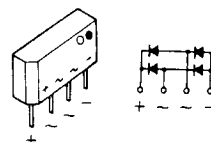

SV02

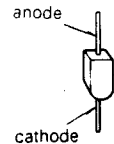

ST-JX22L/22LB ST-JX22L/22LB

C

D

E

F

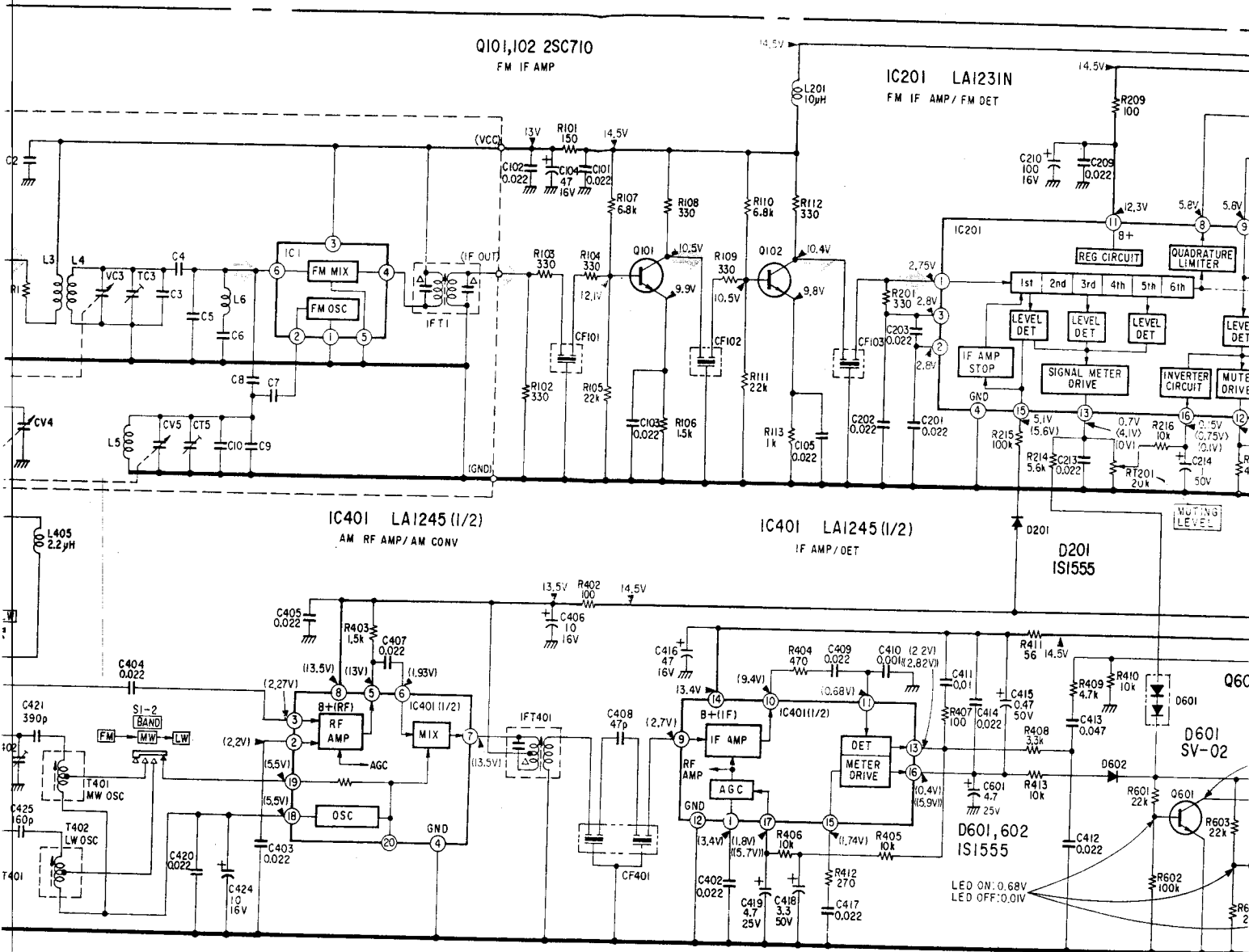

1S1555
EQB01-15

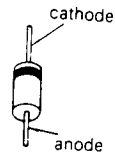

SV02

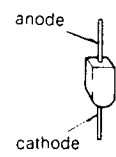

SIVB20

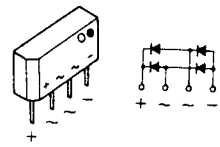

- All capacitors are in μF unless otherwise noted. pF : μF 50VV or less are not indicated except for electrolytic and tantalums.
 - All resistors are in ohms, $\frac{1}{4}$ W unless otherwise noted. k Ω : 1000 Ω , M Ω : 1000 k Ω
 - Δ : internal component.
 - : panel designation.
 - : adjustment for repair.
 - : B+ bus.
 - Readings are taken under no-signal (detuned) condition with a VOM (20 k Ω /V)
- | | | |
|---------|--------------------------|---------------------|
| no mark | : FM (Detuned condition) | } ST/MUTE |
| < > | : FM (Tuned condition) | |
| () | : AM (Detuned condition) | switch: ON |
| ◀ ▶ | : FM (Detuned condition) | } ST/MUTE switch: (|
| (()) | : AM (Tuned condition) | |

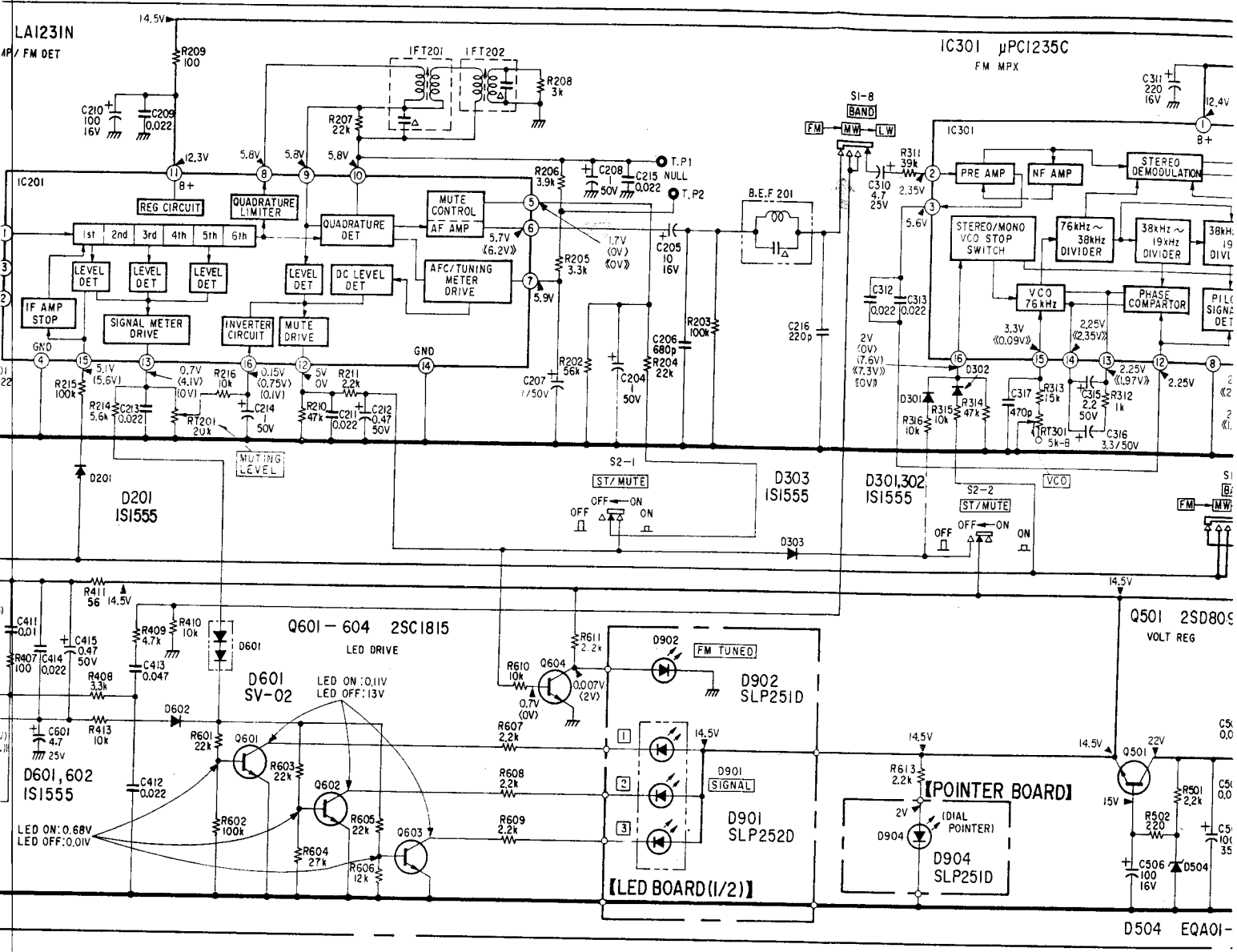

are in μF unless otherwise noted. $\text{pF} : \mu\mu\text{F}$
 are not indicated except for electrolytics

are in ohms, $\frac{1}{4}\text{W}$ unless otherwise noted.
 $\text{M}\Omega : 1000 \text{ k}\Omega$

al component.
 designation.
 ment for repair.
 us.

taken under no-signal (detuned) conditions.
 $20 \text{ k}\Omega/\text{V}$

M (Detuned condition) } ST/MUTE
 M (Tuned condition) } switch: ON
 M (Detuned condition) }
 M (Detuned condition) ST/MUTE switch: OFF
 M (Tuned condition) }

• → : signal path

Note: Voltage are measured with a VOM (50k Ω /V)

Note: The components identified by shading and mark Δ are critical for safety. Replace only with part number specified.

For Service Manuals Contact
MAURITRON TECHNICAL SERVICES
 8 Cherry Tree Rd, Chinnor
 Oxon OX9 4QY
 Tel: 01844-351694 Fax: 01844-352554
 Email: enquiries@mauritron.co.uk

H I J K

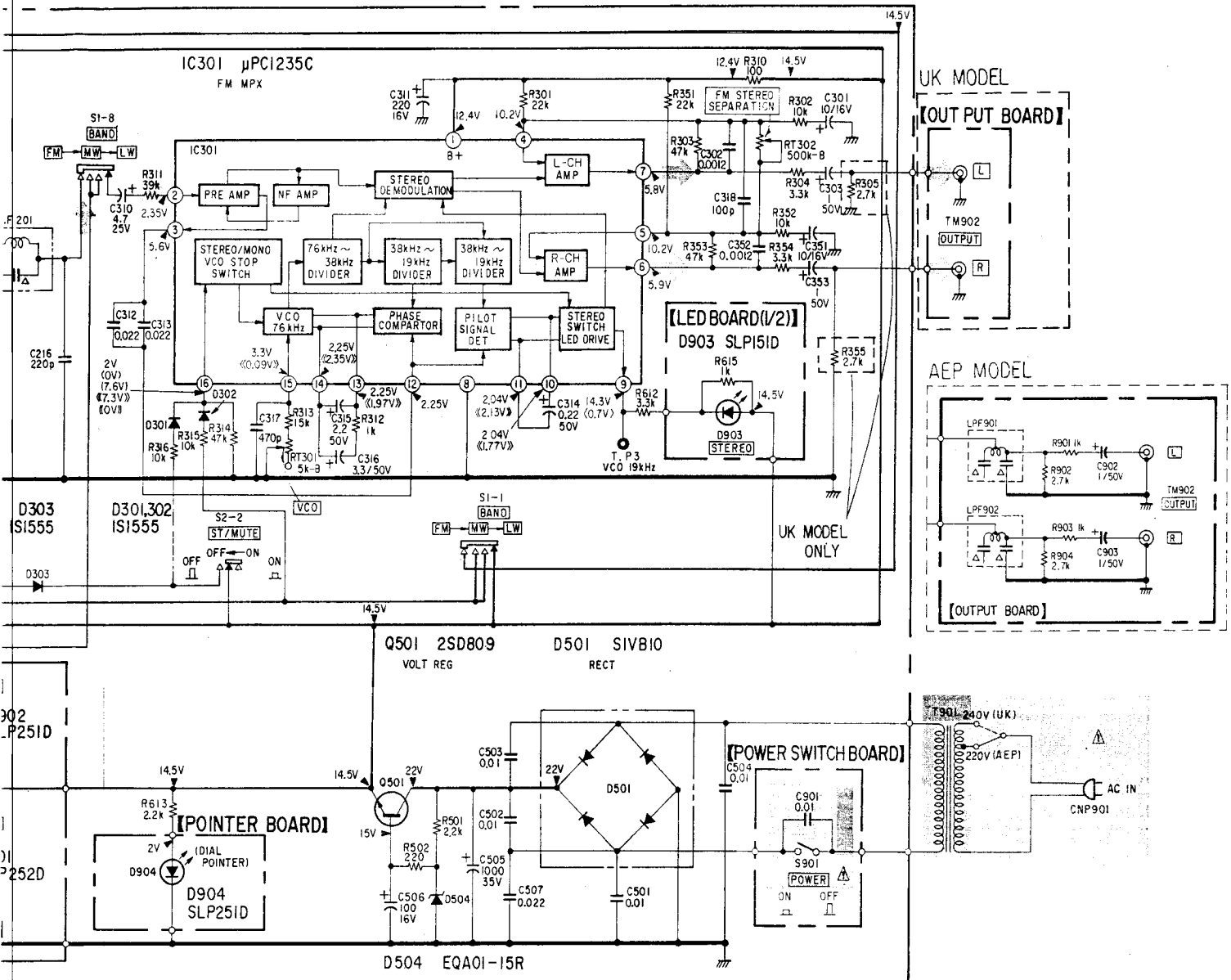

h a VOM (50kΩ/V)

ed by shading and mark
ty. Replace only with

For Service Manuals Contact
MAURITRON TECHNICAL SERVICES
 8 Cherry Tree Rd, Chinnor
 Oxon OX9 4QY
 Tel: 01844-351694 Fax: 01844-352554
 Email: enquiries@mauritron.co.uk

SECTION 5
EXPLODED VIEW AND PARTS LIST

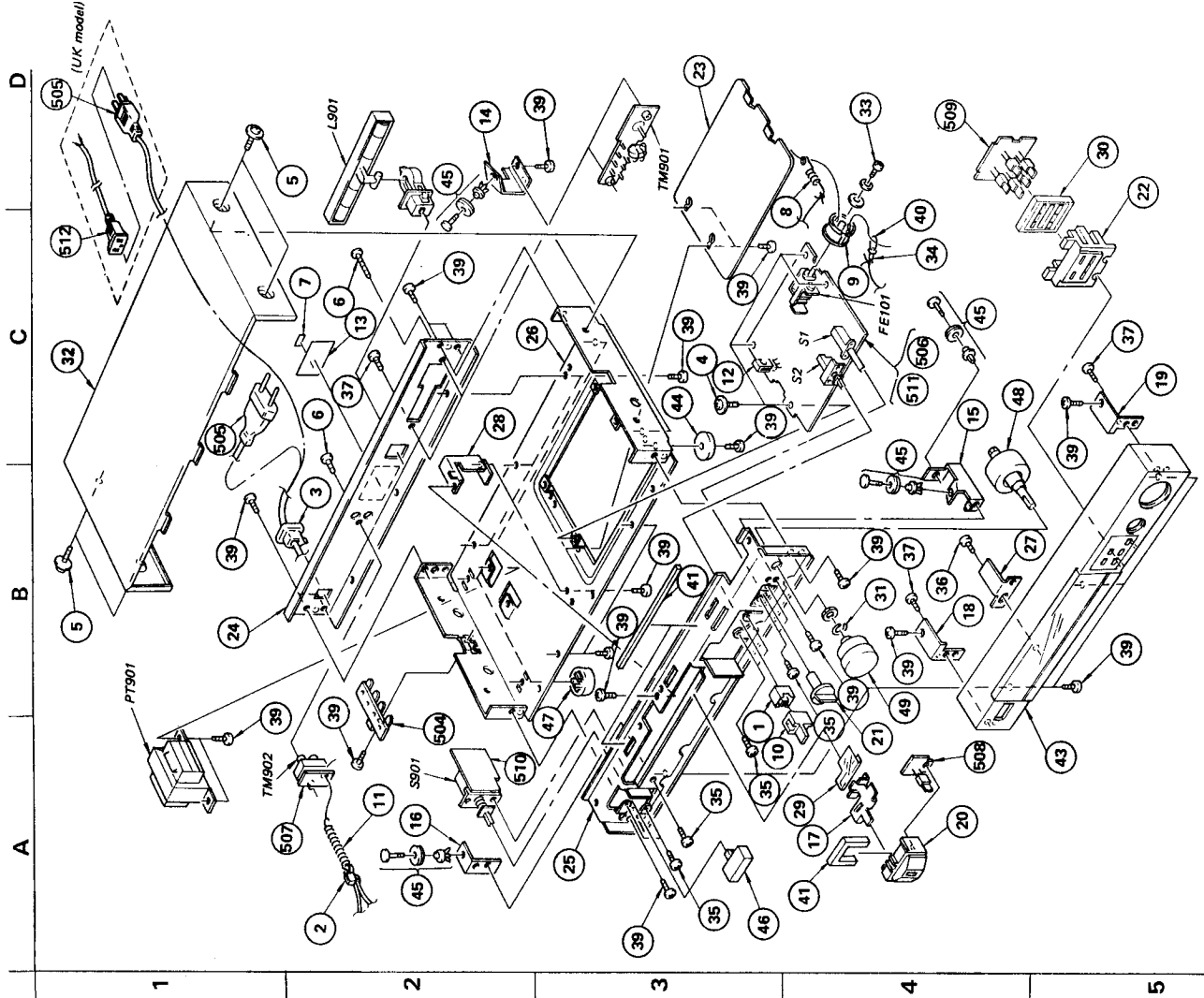

GENERAL SECTION

No.	Part No.	Description
36	7-685-134-11	SCREEN +P 2.6X8 TYPEZ NON-SLIT
37	7-685-646-11	SCREEN +BVTIP 3X8 TYPEZ N+S
38	7-688-003-01	W3, SMALL
39	7-685-871-01	SCREEN +BVTIP 3X6 (S)
40	9-911-825-42	STRING, 0.5MM WHITE
41	9-911-845-XX	CUSHION
42	3-703-396-00	(UK)...LABEL, CAUTION
43	A-4322-426-A	(SILVER)...PANEL ASSY
44	X-4881-508-1	(BLACK)...PANEL ASSY
45	X-3701-069-0	FOOT ASSY, M.F.
46	X-4875-108-0	(SILVER)...KNOB ASSY, POWER
47	X-4881-408-0	(BLACK)...KNOB ASSY, POWER
48	X-4875-123-1	FOOT ASSY, MF
49	X-4881-503-0	(SILVER)...KNOB (DIA.28) ASSY, R
49	X-4881-503-2	(BLACK)...KNOB (DIA.28) ASSY, R

ACCESSORY & PACKING MATERIAL

No.	Part No.	Description
91	1-501-161-00	ANTENNA FEEDER
92	1-511-734-31	CORU, CONNECTION
93	3-701-630-00	BAG, POLYETHYLENE
94
95	3-773-266-11	(JX22LB)...MANUAL, INSTRUCTION (ENGLISH)
95	3-773-266-41	(JX22LB)...MANUAL, INSTRUCTION (GERMANY)
95	3-783-846-11	(JX22: AEP:UK)...MANUAL, INSTRUCTION
96	4-875-040-00	SHEET, PROTECTION
97	4-881-536-00	CUSHION, USER
98	4-881-537-00	CUSHION, LOWER
99	4-881-540-00	(JX22L)...INDIVIDUAL CARTON (MADE IN FRANCE)
99	4-881-542-00	(JX22L)...INDIVIDUAL CARTON (MADE IN JAPAN)
99	4-881-556-00	(JX22LB)...INDIVIDUAL CARTON (MADE IN JAPAN)
99	4-881-558-00	(JX22LB)...INDIVIDUAL CARTON (MADE IN FRANCE)

GENERAL SECTION

No.	Part No.	Description
1	3-302-902-00	(SILVER)...KNOB, PUSH
1	3-302-902-41	(BLACK)...KNOB, PUSH
2	3-671-893-00	CLAMP (LOW TYPE)
3	3-703-244-00	BUSHING, CORD
4	3-703-249-01	SCREEN, S TIGHT, +PTMH 3X6
5	3-703-354-01	(BLACK)...SCREEN (OS), CASE, CLAW
5	3-703-354-11	(SILVER)...SCREEN (OS), CASE, CLAW
6	3-703-473-00	SCREEN, TERMINAL (SMALL), FTZ
7	3-603-356-01	LEVEL (188S)
8	4-809-050-00	SPRING, TENSION
9	4-859-586-01	DRUM (16S), DIAL
10	4-864-307-00	RING
11	4-864-520-00	SPRING, TENSION
12	4-866-080-00	HEAT SINK
13	4-881-506-00	(JX22: AEP)...LABEL, MODEL NUMBER
13	4-881-507-00	(JX22: UK)...LABEL, MODEL NUMBER
13	4-881-554-00	(JX22LB: AEP)...LABEL, MODEL NUMBER
13	4-881-555-00	(JX22LB: UK)...LABEL, MODEL NUMBER
14	4-881-512-00	BRACKET (A), PULLEY
15	4-881-513-00	BRACKET (B), PULLEY
16	4-881-514-00	BRACKET (C), PULLEY
17	4-881-515-00	BRACKET, POINTER
18	4-881-516-02	BRACKET (LEFT), PANEL
19	4-881-517-02	BRACKET (RIGHT), PANEL
20	4-881-519-00	POINTER
21	4-881-520-01	(SILVER)...KNOB (DIA. 18)
21	4-881-520-11	(BLACK)...KNOB (DIA. 18)
22	4-881-521-00	HOLDER, LED
23	4-881-522-00	PLATE, BOTTOM
24	4-881-525-11	(AEP)...PLATE, JACK
24	4-881-525-21	(UK)...PLATE, JACK
25	4-881-526-00	PANEL, SUB
26	4-881-529-00	CHASSIS
27	4-881-531-00	BRACKET (C), PANEL
28	4-881-533-00	REINFORCEMENT
29	4-881-534-00	HOLDER
30	4-881-535-00	HOLDER
31	4-881-539-00	RING
32	4-881-528-00	(SILVER)...CASE
32	4-881-528-21	(BLACK)...CASE
33	7-621-759-45	+PSW, 2.6X6
34	7-623-615-01	EYELET, 2X2
35	7-682-147-09	SCREEN +P 3X6

NOTE:
 Items with no part number and no description are not stocked because they are seldom required for routine service.
 Items marked " " are not stocked since they are seldom required for routine service. Some items should be anticipated when ordering these items.
 Due to standardization, parts with part numbers (0-040-040-XX or 0-040-040-XX) may be different from those used in the set.

CAPACITORS:
 All capacitors are in uF. Common capacitors are omitted. Refer to the following lists for their part numbers.
 ME: uF, PF: pF.

RESISTORS
 All resistors are in ohms. Common 1/4W, 1/8W and 1/16W carbon resistors are omitted. Refer to the following lists for their part numbers.
 F: nonflammable

COILS
 MH: mH, UH: uH

ELECTRICAL PARTS

Ref.No.	Part No.	Description
501	▲;1-535-115-00	TERMINAL
502	▲;1-535-116-00	TERMINAL
503	▲;1-535-117-00	TERMINAL
504	1-536-392-XX	L-TYPE TERMINAL STRIP
505	▲;1-551-427-11	(AEP)...CORD, POWER, EULO PLUG
505	▲;1-551-963-00	(UK)...CORD, POWER
506	▲;1-607-339-00	PC BOARD, TUNER
507	▲;1-607-784-00	(AEP)...PC BOARD, OUTPUT
507	▲;1-607-340-00	(UK)...PC BOARD, OUTPUT
508	▲;1-607-341-00	PC BOARD, POINTER
509	▲;1-607-342-00	PC BOARD, LED
510	▲;1-607-343-00	PC BOARD, POWER SWITCH
511	▲;A-4351-305-A	(AEP)...MOUNTED PCB, TUNER
511	▲;A-4351-312-A	(UK)...MOUNTED PCB, TUNER
512	▲;1-551-967-00	(UK)...CORD, POWER
C216	1-161-315-00	CERAMIC 220PF 10% 50V
C410	1-161-323-00	CERAMIC 0.001MF 10% 50V
C426	1-161-373-51	CERAMIC 75PF 5% 50V
CF101	1-527-968-81	FILTER, CERAMIC
CF102	1-527-968-81	FILTER, CERAMIC
CF103	1-527-968-81	FILTER, CERAMIC
CF401	1-527-937-00	FILTER, CERAMIC
CT401	1-141-180-00	CAP, TRIMMER
CT402	1-141-180-00	CAP, TRIMMER
CT403	1-141-180-00	CAP, TRIMMER
CT404	1-141-180-00	CAP, TRIMMER
D201	8-719-815-55	DIODE 1S1555
D301	8-719-815-55	DIODE 1S1555
D302	8-719-815-55	DIODE 1S1555
D303	8-719-815-55	DIODE 1S1555
D501	8-719-511-20	DIODE 1SVB20
D504	8-719-931-15	DIODE EQB01-15
D601	8-719-300-02	DIODE SV02
D602	8-719-815-55	DIODE 1S1555
D901	8-719-901-78	DIODE SLP252D-03
D902	8-719-902-52	DIODE SLP251D
D903	8-719-901-53	DIODE SLP151D
D904	8-719-902-52	DIODE SLP251D

ELECTRICAL PARTS

Ref.No.	Part No.	Description
F201	1-235-126-00	ENCAPSULATED COMPONENT
FE101	1-463-405-00	FRONT END
IC201	8-759-812-31	IC LA1231
IC301	8-759-112-35	IC UPC1235C
IC401	8-759-812-45	IC LA1245
IFT201	1-404-400-00	TRANSFORMER, DISCRIMINATOR
IFT202	1-404-401-00	TRANSFORMER, DISCRIMINATOR
IFT401	1-404-383-00	TRANSFORMER, IF
L201	1-407-157-XX	MICRO INDUCTOR 10UH
L401	1-407-708-00	MICRO INDUCTOR 180UH
L402	1-407-750-00	MICRO INDUCTOR 100UH
L404	1-408-109-00	MICRO INDUCTOR 2.2UH
L405	1-408-109-00	MICRO INDUCTOR 2.2UH
L901	1-401-978-00	ANTENNA, FERRITE-ROD (LW/MW)
LPF901	1-235-138-00	(AEP)..FILTER, LOW PASS
LPF902	1-235-138-00	(AEP)..FILTER, LOW PASS
PT901	▲;1-447-314-00	TRANSFORMER, POWER
Q101	8-729-671-15	TRANSISTOR 2SC710-15
Q102	8-729-671-15	TRANSISTOR 2SC710-15
Q501	8-729-180-93	TRANSISTOR 2SD809-F
Q601	8-729-663-47	TRANSISTOR 2SC1364
Q602	8-729-663-47	TRANSISTOR 2SC1364
Q603	8-729-663-47	TRANSISTOR 2SC1364
Q604	8-729-663-47	TRANSISTOR 2SC1364
RT201	1-226-237-00	RES, ADJ, CARBON 20K
RT301	1-228-160-11	(AEP)...RES, ADJ, CARBON 5K
RT301	1-226-235-00	(UK)...RES, ADJ, CARBON 5K
RT302	1-226-241-00	RES, ADJ, CARBON 500K
S1	1-554-131-00	SWITCH, ROTARY SLIDE
S2	1-554-128-00	SWITCH, PUSH (1 KEY)
S901	▲;1-553-072-21	SWITCH, PUSH
T401	1-405-953-00	COIL (OSC)
T402	1-405-954-00	COIL (OSC)
TM901	1-536-666-21	TERMINAL BOARD (ANTENNA) (INCLUDING L902,CO01)
TM902	1-507-731-00	JACK, PIN 2P

For Service Manuals Contact
MAURITRON TECHNICAL SERVICES
 8 Cherry Tree Rd, Chinnor
 Oxon OX9 4QY
 Tel: 01844-351694 Fax: 01844-352554
 Email: enquiries@mauritron.co.uk

NOTE:

- Items with no part number and no description are not stocked because they are seldom required for routine service.
- Items marked "▲" are not stocked since they are seldom required for routine service. Some delay should be anticipated when ordering these items.
- Due to standardization, parts with part numbers (▲-▲▲▲-▲▲▲-XX or ▲-▲▲▲-▲▲▲-X) may be different from those used in the set.

CAPACITORS:

- All capacitors are in μF . Common capacitors are omitted. Refer to the following lists for their part numbers.
 MF: μF , PF: μF .

RESISTORS

- All resistors are in ohms. Common 1/4W, 1/8W and 1/16W carbon resistors are omitted. Refer to the following lists for their part numbers.

- F : nonflammable

COILS

- MMH : mH, UH : μH

The components identified by shading and mark ▲ are critical for safety. Replace only with part number specified.

SEMICONDUCTORS

- In each case, U : μ , for example:
 UA...: μA ..., UPA...: μPA ..., UPC...: μPC ,
 UPD...: μPD ...

ELECTROLYTIC CAPACITORS

CAP. (μF)	RATING → : Use the high voltage rated one.					
	6.3 VOLT.	10 VOLT.	16 VOLT.	25 VOLT.	35 VOLT.	50 VOLT.
	PART No.	PART No.	PART No.	PART No.	PART No.	PART No.
0.47					→	1-121-726-00
1.0					→	1-121-391-00
2.2					→	1-121-450-00
3.3	→			1-121-392-00	→	1-121-393-00
4.7	→			1-121-395-00	→	1-121-396-00
10	→		1-121-651-00	1-121-398-00	→	1-121-738-00
22	→		1-121-479-00	1-121-480-00	1-121-662-00	1-121-152-00
33	→		1-121-403-00	1-121-404-00	1-121-652-00	1-121-405-00
47	→	1-121-352-00	1-121-409-00	1-121-410-00	1-121-653-00	1-121-411-00
100	→	1-121-414-00	1-121-415-00	1-121-416-00	1-121-357-00	1-121-417-00
220	1-121-419-00	1-121-420-00	1-121-421-00	1-121-422-00	1-121-261-00	1-121-423-00
330	1-121-751-00	1-121-805-00	1-121-521-00	1-121-654-00	1-121-655-00	1-121-656-00
470	1-121-424-00	1-121-425-00	1-121-426-00	1-121-733-00	1-121-361-00	1-121-810-00
1000		1-121-736-00	1-121-245-00	1-121-657-00	1-121-388-00	1-123-061-00
2200	1-121-658-00	1-121-659-00	1-121-660-00	1-123-067-00	1-121-984-00	
3300	1-121-661-00	1-123-075-00	1-123-071-00			

CAP. (μF)	100 VOLT.	160 VOLT.	250 VOLT.	350 VOLT.
	PART No.	PART No.	PART No.	PART No.
0.47				
1.0	1-123-249-00	1-123-252-00	1-123-003-00	1-121-168-00
2.2	1-123-250-00	1-123-026-00		1-123-028-00
3.3	1-121-995-00		1-123-004-00	1-123-006-00
4.7	1-123-255-00	1-121-246-00	1-121-759-00	1-123-007-00
10	1-121-126-00	1-121-999-00	1-123-254-00	1-123-008-00
22	1-121-996-00	1-123-253-00	1-123-005-00	1-123-022-00
33	1-121-997-00	1-121-757-00		
47	1-123-251-00	1-121-919-00		
100	1-123-084-00			

CERAMIC CAPACITORS

RATING							
CAP. (pF)	50 VOLT.	CAP. (pF)	50 VOLT.	CAP. (pF)	50 VOLT.	CAP. (μF)	50 VOLT.
	PART No.		PART No.		PART No.		PART No.
0.5	1-101-837-00	22	1-102-959-00	150	1-101-361-00	0.001	1-102-074-00
0.75	1-101-586-00	24	1-102-960-00	160	1-101-367-00	0.0012	1-102-118-00
1.0	1-102-934-00	27	1-102-961-00	180	1-102-976-00	0.0015	1-102-119-00
1.5	1-101-576-00	30	1-102-962-00	200	1-102-977-00	0.0018	1-102-120-00
2.0	1-102-935-00	33	1-102-963-00	220	1-102-978-00	0.0022	1-102-121-00
3	1-102-936-00	36	1-102-964-00	240	1-102-979-00	0.0027	1-102-122-00
4	1-102-937-00	39	1-102-965-00	270	1-102-980-00	0.0033	1-102-123-00
5	1-102-942-00	43	1-102-966-00	300	1-102-981-00	0.0039	1-102-124-00
6	1-102-943-00	47	1-101-880-00	330	1-102-820-00	0.0047	1-102-125-00
7	1-102-944-00	51	1-101-882-00	360	1-102-821-00	0.0056	1-102-126-00
8	1-102-945-00	56	1-101-884-00	390	1-102-822-00	0.0068	1-102-127-00
9	1-102-946-00	62	1-101-886-00	430	1-102-823-00	0.0082	1-102-128-00
10	1-102-947-00	68	1-101-888-00	470	1-102-824-00	0.01	1-102-129-00
11	1-102-948-00	75	1-101-890-00	510	1-101-059-00	0.022	1-101-005-00
12	1-102-949-00	82	1-102-971-00	560	1-102-115-00	0.047	1-101-006-00
13	1-102-950-00	91	1-102-972-00	680	1-102-116-00		
15	1-102-951-00	100	1-102-973-00	820	1-102-117-00		
16	1-102-952-00	110	1-102-815-00				
18	1-102-953-00	120	1-102-816-00				
20	1-102-958-00	130	1-101-081-00				

0.001μF = 1,000pF

CERAMIC (SEMICONDUCTOR) CAPACITORS

RATING → : Use the high voltage rated one.					
CAP. (μF)	25 VOLT.	50 VOLT.	CAP. (μF)	25 VOLT.	50 VOLT.
	PART No.	PART No.		PART No.	PART No.
0.001	→	1-161-039-00	0.018	1-161-016-00	1-161-054-00
0.0012	→	1-161-040-00	0.022	1-161-017-00	1-161-055-00
0.0015		1-161-041-00	0.027	1-161-018-00	1-161-056-00
0.0018		1-161-042-00	0.033	1-161-019-00	1-161-057-00
0.0022		1-161-043-00	0.039	1-161-010-00	1-161-058-00
0.0027	→	1-161-044-00	0.047	1-161-021-00	1-161-059-00
0.0033	→	1-161-045-00	0.056	→	1-161-060-00
0.0039	→	1-161-046-00	0.068	→	1-161-061-00
0.0047	→	1-161-047-00	0.082	1-161-024-00	1-161-062-00
0.0056	→	1-161-048-00	0.1	1-161-025-00	1-161-063-00
0.0068	→	1-161-049-00			
0.0082	1-161-012-00	1-161-050-00			
0.01	1-161-013-00	1-161-051-00			
0.012	→	1-161-052-00			
0.015	1-161-015-00	1-161-053-00			

MYLAR CAPACITORS

RATING											
CAP. (μF)	50 VOLT.	100 VOLT.	200 VOLT.	CAP. (μF)	50 VOLT.	100 VOLT.	200 VOLT.	CAP. (μF)	50 VOLT.	100 VOLT.	200 VOLT.
	PART No.	PART No.	PART No.		PART No.	PART No.	PART No.		PART No.	PART No.	PART No.
0.001	1-108-227-00	1-108-365-00	1-108-409-00	0.01	1-108-239-00	1-108-377-00	1-108-421-00	0.1	1-108-251-00	1-108-389-00	1-108-433-00
0.0012	1-108-351-00	1-108-366-00	1-108-410-00	0.012	1-108-357-00	1-108-378-00	1-108-422-00	0.12	1-108-363-00	1-108-390-00	1-108-434-00
0.0015	1-108-228-00	1-108-367-00	1-108-411-00	0.015	1-108-240-00	1-108-379-00	1-108-423-00	0.15	1-108-252-00	1-108-391-00	1-108-435-00
0.0018	1-108-352-00	1-108-368-00	1-108-412-00	0.018	1-108-358-00	1-108-380-00	1-108-424-00	0.18	1-108-364-00	1-108-392-00	1-108-436-00
0.0022	1-108-220-00	1-108-369-00	1-108-413-00	0.022	1-108-242-00	1-108-381-00	1-108-425-00	0.22	1-108-254-00	1-108-393-00	1-108-437-00
0.0027	1-108-353-00	1-108-370-00	1-108-414-00	0.027	1-108-359-00	1-108-382-00	1-108-426-00	0.27	1-108-854-00	-	-
0.0033	1-108-232-00	1-108-371-00	1-108-415-00	0.033	1-108-244-00	1-108-383-00	1-108-427-00	0.33	1-108-855-00	-	-
0.0039	1-108-354-00	1-108-372-00	1-108-416-00	0.039	1-108-360-00	1-108-384-00	1-108-428-00	0.39	1-108-856-00	-	-
0.0047	1-108-234-00	1-108-373-00	1-108-417-00	0.047	1-108-246-00	1-108-385-00	1-108-429-00	0.47	1-108-857-00	-	-
0.0056	1-108-355-00	1-108-374-00	1-108-418-00	0.056	1-108-361-00	1-108-386-00	1-108-430-00				
0.0068	1-108-237-00	1-108-375-00	1-108-419-00	0.068	1-108-249-00	1-108-387-00	1-108-431-00				
0.0082	1-108-356-00	1-108-376-00	1-108-420-00	0.082	1-108-362-00	1-108-388-00	1-108-432-00				

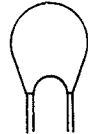

TANTALUM CAPACITORS

RATING → Use the high voltage rated one.							
CAP. (μF)	3.15 VOLT.	6.3 VOLT.	10 VOLT.	16 VOLT.	20 VOLT.	25 VOLT.	35 VOLT.
	PART No.	PART No.	PART No.	PART No.	PART No.	PART No.	PART No.
0.01					→	→	1-131-396-00
0.015					→	→	1-131-397-00
0.022					→	→	1-131-398-00
0.033					→	→	1-131-399-00
0.047					→	→	1-131-400-00
0.068					→	→	1-131-401-00
0.1					→	→	1-131-402-00
0.15					→	→	1-131-403-00
0.22					→	→	1-131-404-00
0.33					→	1-131-409-00	1-131-405-00
0.47	-	-	-	-	1-131-412-00	→	1-131-406-00
0.68	-	-	-	1-131-415-00	→	1-131-410-00	1-131-407-00
1.0	-	-	1-131-418-00	-	1-131-413-00	→	1-131-408-00
1.5	-	1-131-421-00	-	1-131-416-00	→	1-131-411-00	1-131-348-00
2.2	1-131-424-00	-	1-131-419-00	-	1-131-414-00	→	1-131-349-00
3.3	-	1-131-422-00	-	1-131-417-00	1-131-362-00	1-131-356-00	1-131-350-00
4.7	1-131-425-00	-	1-131-420-00	1-131-369-00	1-131-363-00	1-131-357-00	1-131-351-00
6.8	-	1-131-423-00	1-131-376-00	1-131-370-00	1-131-364-00	1-131-358-00	1-131-352-00
10	1-131-426-00	1-131-383-00	1-131-377-00	1-131-371-00	1-131-365-00	1-131-359-00	1-131-353-00
15	1-131-390-00	1-131-384-00	1-131-378-00	1-131-372-00	1-131-366-00	1-131-360-00	-
22	1-131-391-00	1-131-385-00	1-131-379-00	1-131-373-00	1-131-367-00		
33	1-131-392-00	1-131-386-00	1-131-380-00	1-131-374-00			
47	1-131-393-00	1-131-387-00	1-131-381-00				
68	1-131-394-00	1-131-388-00					
100	1-131-395-00						

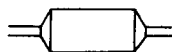

TANTALUM CAPACITORS

RATING						
CAP. (μF)	3 VOLT.	6.3 VOLT.	10 VOLT.	16 VOLT.	20 VOLT.	35 VOLT.
	PART No.	PART No.	PART No.	PART No.	PART No.	PART No.
0.033						1-131-273-00
0.047						1-131-274-00
0.068						1-131-275-00
0.1						1-131-276-00
0.15						1-131-277-00
0.22						1-131-278-00
0.33					1-131-262-00	1-131-278-00
0.47					1-131-263-00	1-131-279-00
0.68			1-131-169-00		1-131-264-00	1-131-280-00
1.0				1-131-258-00	1-131-265-00	1-131-281-00
1.5		1-131-250-00			1-131-266-00	1-131-282-00
2.2				1-131-259-00	1-131-267-00	1-131-283-00
3.3					1-131-268-00	1-131-284-00
4.7		1-131-251-00	1-131-171-00		1-131-269-00	-
6.8				1-131-260-00	1-131-270-00	-
10			1-131-256-00		1-131-271-00	-
15				1-131-261-00	1-131-272-00	-
22		1-131-252-00				
33	1-131-176-00	1-131-253-00	1-131-173-00			
47	1-131-288-00	1-131-174-00				
100	1-131-177-00					

For Service Manuals Contact
MAURITRON TECHNICAL SERVICES
 8 Cherry Tree Rd, Chinnor
 Oxon OX9 4QY
 Tel: 01844-351694 Fax: 01844-352554
 Email: enquiries@mauritron.co.uk

1/4 WATT CARBON RESISTORS

Ω	Part No.	Ω	Part No.	Ω	Part No.	Ω	Part No.	Ω	Part No.	Ω	Part No.	Ω	Part No.
1.0	1-246-401-00	10	1-246-425-00	100	1-246-449-00	1.0k	1-246-473-00	10k	1-246-497-00	100k	1-246-521-00	1.0M	1-246-545-00
1.1	1-246-402-00	11	1-246-426-00	110	1-246-450-00	1.1k	1-246-474-00	11k	1-246-498-00	110k	1-246-522-00	1.1M	1-210-814-00
1.2	1-246-403-00	12	1-246-427-00	120	1-246-451-00	1.2k	1-246-475-00	12k	1-246-499-00	120k	1-246-523-00	1.2M	1-210-815-00
1.3	1-246-404-00	13	1-246-428-00	130	1-246-452-00	1.3k	1-246-476-00	13k	1-246-500-00	130k	1-246-524-00	1.3M	1-210-816-00
1.5	1-246-405-00	15	1-246-429-00	150	1-246-453-00	1.5k	1-246-477-00	15k	1-246-501-00	150k	1-246-525-00	1.5M	1-210-817-00
1.6	1-246-406-00	16	1-246-430-00	160	1-246-454-00	1.6k	1-246-478-00	16k	1-246-502-00	160k	1-246-526-00	1.6M	1-210-818-00
1.8	1-246-407-00	18	1-246-431-00	180	1-246-455-00	1.8k	1-246-479-00	18k	1-246-503-00	180k	1-246-527-00	1.8M	1-210-819-00
2.0	1-246-408-00	20	1-246-432-00	200	1-246-456-00	2.0k	1-246-480-00	20k	1-246-504-00	200k	1-246-528-00	2.0M	1-210-820-00
2.2	1-246-409-00	22	1-246-433-00	220	1-246-457-00	2.2k	1-246-481-00	22k	1-246-505-00	220k	1-246-529-00	2.2M	1-210-821-00
2.4	1-246-410-00	24	1-246-434-00	240	1-246-458-00	2.4k	1-246-482-00	24k	1-246-506-00	240k	1-246-530-00	2.4M	1-244-754-00
2.7	1-246-411-00	27	1-246-435-00	270	1-246-459-00	2.7k	1-246-483-00	27k	1-246-507-00	270k	1-246-531-00	2.7M	1-244-755-00
3.0	1-246-412-00	30	1-246-436-00	300	1-246-460-00	3.0k	1-246-484-00	30k	1-246-508-00	300k	1-246-532-00	3.0M	1-244-756-00
3.3	1-246-413-00	33	1-246-437-00	330	1-246-461-00	3.3k	1-246-485-00	33k	1-246-509-00	330k	1-246-533-00	3.3M	1-244-757-00
3.6	1-246-414-00	36	1-246-438-00	360	1-246-462-00	3.6k	1-246-486-00	36k	1-246-510-00	360k	1-246-534-00	3.6M	1-244-758-00
3.9	1-246-415-00	39	1-246-439-00	390	1-246-463-00	3.9k	1-246-487-00	39k	1-246-511-00	390k	1-246-535-00	3.9M	1-244-759-00
4.3	1-246-416-00	43	1-246-440-00	430	1-246-464-00	4.3k	1-246-488-00	43k	1-246-512-00	430k	1-246-536-00	4.3M	1-244-760-00
4.7	1-246-417-00	47	1-246-441-00	470	1-246-465-00	4.7k	1-246-489-00	47k	1-246-513-00	470k	1-246-537-00	4.7M	1-244-761-00
5.1	1-246-418-00	51	1-246-442-00	510	1-246-466-00	5.1k	1-246-490-00	51k	1-246-514-00	510k	1-246-538-00	5.1M	1-244-762-00
5.6	1-246-419-00	56	1-246-443-00	560	1-246-467-00	5.6k	1-246-491-00	56k	1-246-515-00	560k	1-246-539-00		
6.2	1-246-420-00	62	1-246-444-00	620	1-246-468-00	6.2k	1-246-492-00	62k	1-246-516-00	620k	1-246-540-00		
6.8	1-246-421-00	68	1-246-445-00	680	1-246-469-00	6.8k	1-246-493-00	68k	1-246-517-00	680k	1-246-541-00		
7.5	1-246-422-00	75	1-246-446-00	750	1-246-470-00	7.5k	1-246-494-00	75k	1-246-518-00	750k	1-246-542-00		
8.2	1-246-423-00	82	1-246-447-00	820	1-246-471-00	8.2k	1-246-495-00	82k	1-246-519-00	820k	1-246-543-00		
9.1	1-246-424-00	91	1-246-448-00	910	1-246-472-00	9.1k	1-246-496-00	91k	1-246-520-00	910k	1-246-544-00		

HARDWARE NOMENCLATURE

Screw:

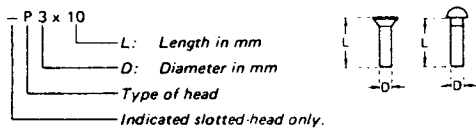

Unless otherwise indicated, it means cross-recessed head (Phillips type).

Nut, Washer, Retaining ring:

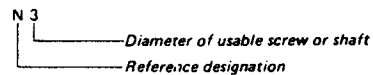

Reference Designation	Shape	Description	Remarks
SCREWS			
P		pan-head screw	binding-head (B) screw for replacement
PWH		pan-head screw with washer face	binding-head (B) screw and flat washer for replacement
PS PSP		pan-head screw with spring washer	binding-head (B) screw and spring washer for replacement
PSW PSPW		pan-head screw with spring and flat washers	binding-head (B) screw and spring and flat washers for replacement
R		round-head screw	binding-head (B) screw for replacement
K		flat-countersunk-head screw	
RK		oval-countersunk-head screw	
B		binding-head screw	
T		truss-head screw	binding-head (B) screw for replacement
F		flat-fillister-head screw	
RF		fillister-head screw	
BV		braizer-head screw	

Reference Designation	Shape	Description	Remarks
SELF-TAPPING SCREWS			
TA		self-tapping screw	ex: TA, P 3 x 10
PTP		pan-head self-tapping screw	binding-head self-tapping (TA, B) screw for replacement
PTPWH		pan-head self-tapping screw with washer face	binding-head self-tapping (TA, B) screw and flat washer for replacement
PTTWH		pan-head thread-rolling screw with washer face	binding-head (B) screw and flat washer for replacement
SET SCREWS			
SC		set screw	
SC		hexagon-socket set screw	ex: SC 2.6 x 4, hexagon socket
NUT			
N		nut	
WASHERS			
W		flat washer	
SW		spring washer	
LW		internal-tooth lock washer	ex: LW3, internal
LW.		external-tooth lock washer	ex: LW3, external
RETAINING RINGS			
E		retaining ring	
G		grip-type retaining ring	

For Service Manuals Contact
MAURITRON TECHNICAL SERVICES
8 Cherry Tree Rd, Chinnor
Oxon OX9 4QY
Tel:- 01844-351694 Fax:- 01844-352554
Email:- enquiries@maurtron.co.uk

Sony Corporation
Consumer Products Group
Technical Support Dept.

SONY®

TROUBLESHOOTING GUIDE

AEP Model
UK Model

ST-JX22L

FM STEREO/FM-AM TUNER

Sony Corporation/Audio & Video Group.

Table of Contents

<u>Description</u>	<u>Page</u>
No FM Sound	3, 4
Poor FM Sensitivity	3, 4
FM Sound Too Small	3, 4
IC201 (FM IF AMP, FM Detection) Troubleshooting	5, 6
IC301 (Stereo Demodulation) Troubleshooting	7, 8
NO AM Sound	9, 10
Poor AM Sensitivity	9, 10
AM Sound Too Small	9, 10

For Service Manuals Contact
MAURITRON TECHNICAL SERVICES
8 Cherry Tree Rd, Chinnor
Oxon OX9 4QY
Tel:- 01844-351694 Fax:- 01844-352554
Email:- enquiries@mauriron.co.uk

This Guide is to facilitate repair.
Please use in conjunction with the Service Manual.

How to use the ST-JX22L Troubleshooting Guide]

Check in numerical order, starting with ①. When the voltages and waveforms differ from the ones in the table, check for the defective part given in the table. If it is normal, proceed to the next number.

How to use the table

Example:

Voltage	Defective Parts
 3 Vp-p	Q103, Q104 R302 ~ R305 C101, C105

Possible defective parts

Normal voltages and waveforms
For a sinusoidal wave:



low frequency



high frequency

The voltages, etc. may differ from those given in the Service Manual. Also, the signal level applied to check for the defective parts has no relation whatsoever to the standard input level and input level for alignments given in the Service Manual.

Cold solders and pattern cuts are not included under "Defective Parts", so please check for these, also.

MEMO)

For Service Manuals Contact
MAURITRON TECHNICAL SERVICES
8 Cherry Tree Rd, Chinnor
Oxon OX9 4QY
Tel: 01844-351694 Fax: 01844-352554
Email: enquiries@mauritron.co.uk

- No FM Sound
- Poor FM Sensitivity
- FM Sound Too Small

Input 98 MHz FM signal from FM ANT plug with FM SSG (60 dB, 1 KHz, deviation (30%) monoral)

Receive FM SSG signal (MUTING: OFF)

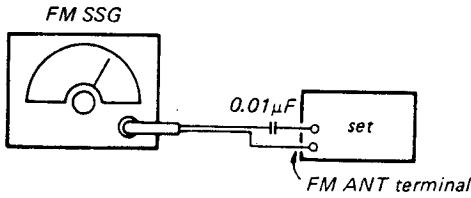

Voltage	Defective Part
 30 m Vp-p	Front end C001, L902

10.7 MHz Front end output waveform

Note: Easy check for FM reception sensitivity.

- Input a 98 MHz FM signal from FM ANT terminal using FM SSG.
- Receive FM SSG signal.

IC201 pin ① IF voltage

Output	Voltage
50 dB	60 m Vp-p
55 dB	100 m Vp-p



Voltage	Defective Part
 60mVp-p	Q101, CF101, C103 R101~R108

10.7MHz IF wavefc

[TUNER BOARD]

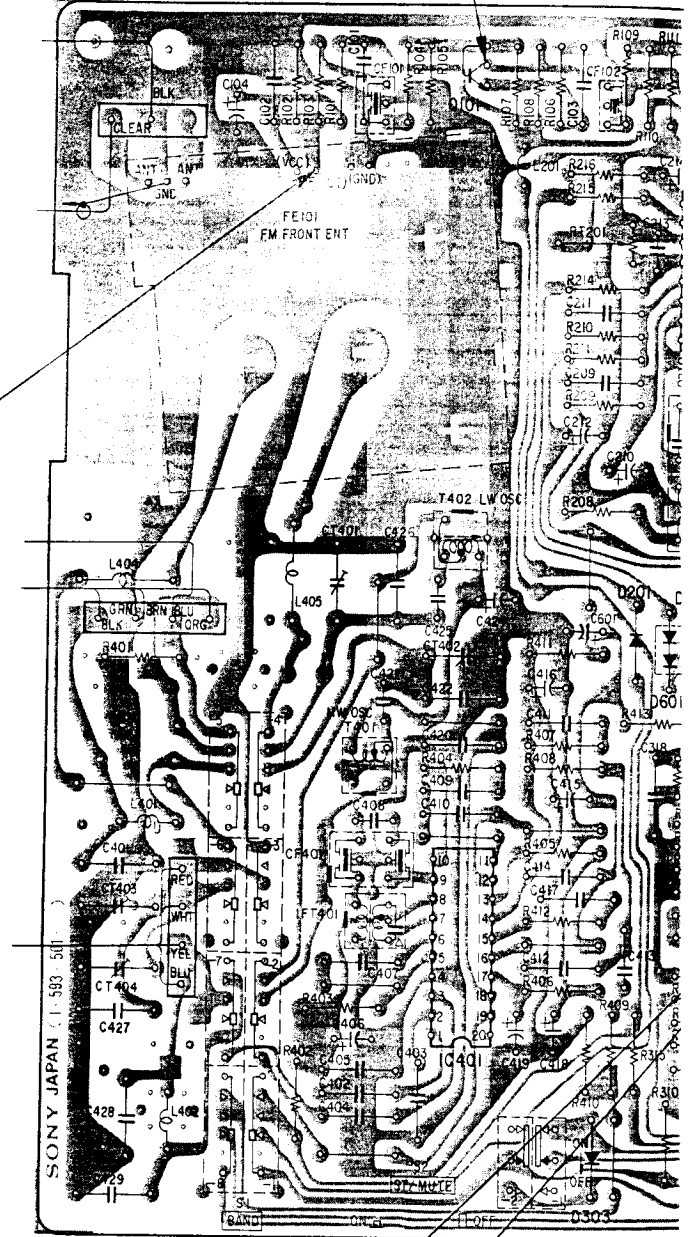

- ⑦
- LW
- MW
- FM

Voltage	Defective Part
 1.6 Vp-p	IC301, D301, R316, S2 L RT302, R301 ~ R303 C318, C301, C302
	IC301, D301, R316, S2 R RT302, R351 ~ R353 C318, C351, C352

1 KHz Signal waveform

ST-JX22L ST-JX22L

②

Voltage	Defective Part
 60mVp-p	Q101, CF101, C103 R101~R108

10.7MHz IF waveform

③

Voltage	Defective Part
 300 m Vp-p	Q102 CF102, C105 R109~R113

10.7 MHz IF Waveform

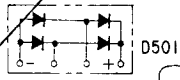

[TUNER BOARD]

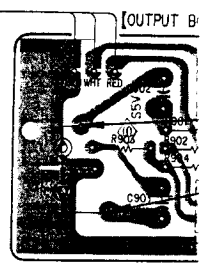
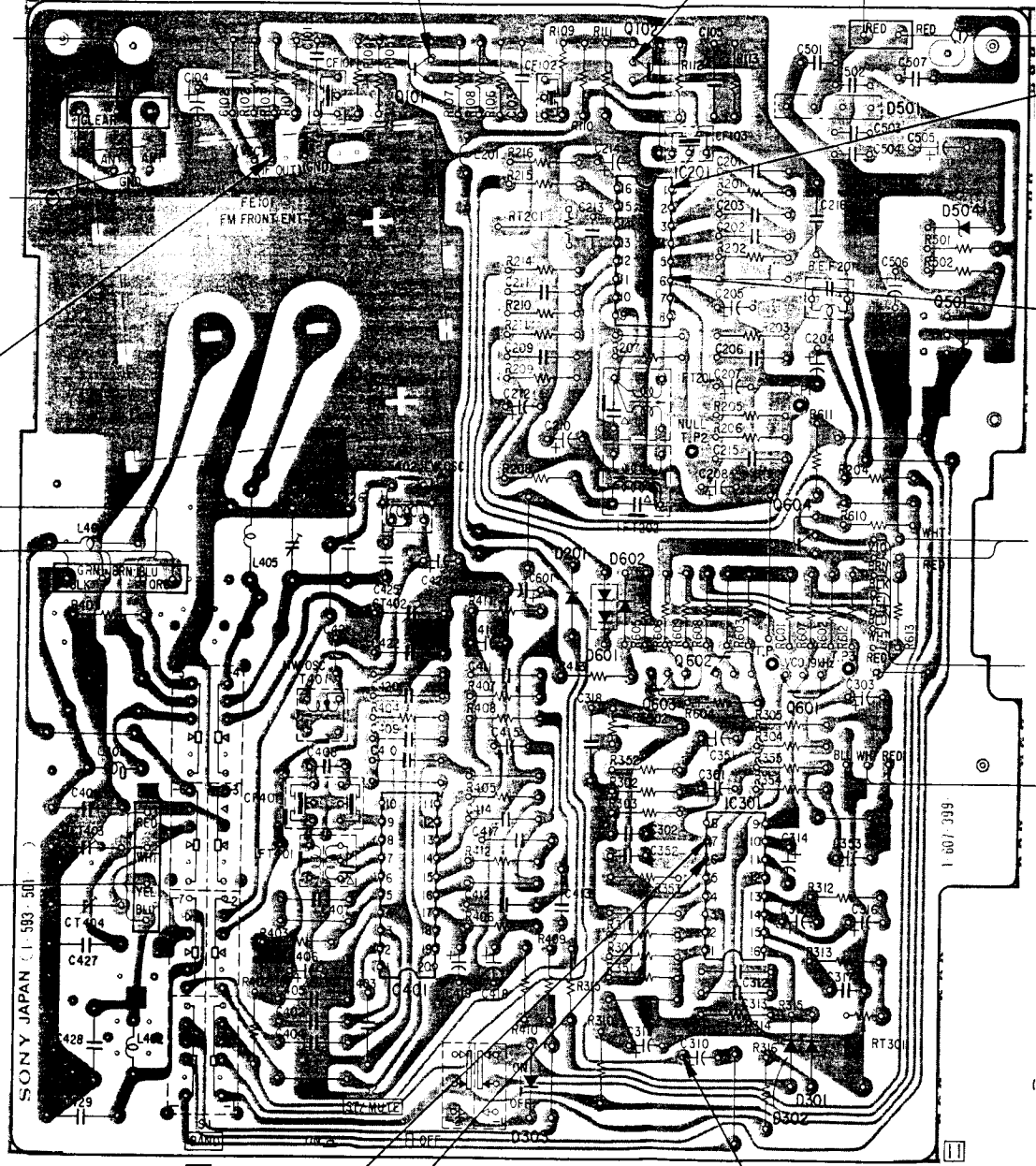

[OUT PUT BOARD]

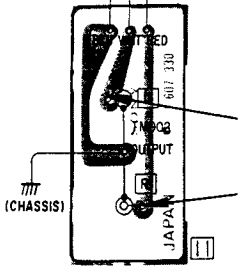

⑦

Voltage	Defective Part
 1.6 Vp-p	L IC301, D301, R316, S2 RT302, R301 ~ R303 C318, C301, C302
	R IC301, D301, R316, S2 RT302, R351 ~ R353 C318, C351, C352

1 KHz Signal waveform

⑥

Voltage	Defective Part
 300 m Vp-p	B.E.F.201 C205, C206 C310, R203

1 KHz MPX Input waveform

Part	Voltage	Defective Part
C103 C108	 300 m Vp-p	Q102 CF102, C105 R109~R113

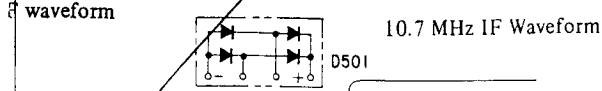

④

Voltage	Defective Part
 200 m Vp-p	CF103 R201 C201 ~ C203

10.7 MHz, IF waveform

⑤

Voltage	Defective Part
 300 m Vp-p	IC201, IFT201, IFT202 RT201, R202, R204 ~ R211 C204, C207 ~ C214

1 KHz, Detected signal waveform

AEP only
Serial No 503001~
No 206031~

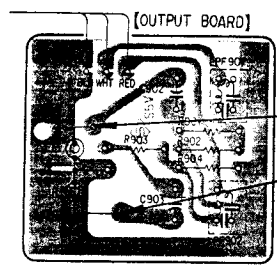

⑧

Voltage	Defective Part
 700mVp-p	L R304, R901, R902, C303, C902 L901
	R R354, R903, R904, C353, C903, L902

1KHz Signal waveform

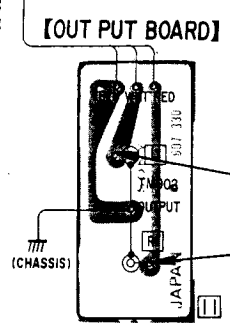

⑧

Voltage	Defective Part
 700 m Vp-p	L R304, R305 C303
	R R354, R355 C353

1 KHz Signal waveform

⑥

Voltage	Defective Part
 300 m Vp-p	B.E.F.201 C205, C206 C310, R203

1 KHz MPX Input waveform

For Service Manuals Contact
MAURITRON TECHNICAL SERVICES
 8 Cherry Tree Rd, Chinnor
 Oxon OX9 4QY
 Tel: 01844-351694 Fax: 01844-352554
 Email: enquiries@maurtron.co.uk

[IC 201 (FM IF amp, FM detection) Troubleshooting.]

Voltage values and waveforms are for reception of the following FM signal input from FM ANT terminal.

- RF frequency 98 MHz
- RF output level 60 dB
- AF frequency 1 KHz
- Modulation rate 30%

R + L STEREO (STEREO/MUTING Switch ON)

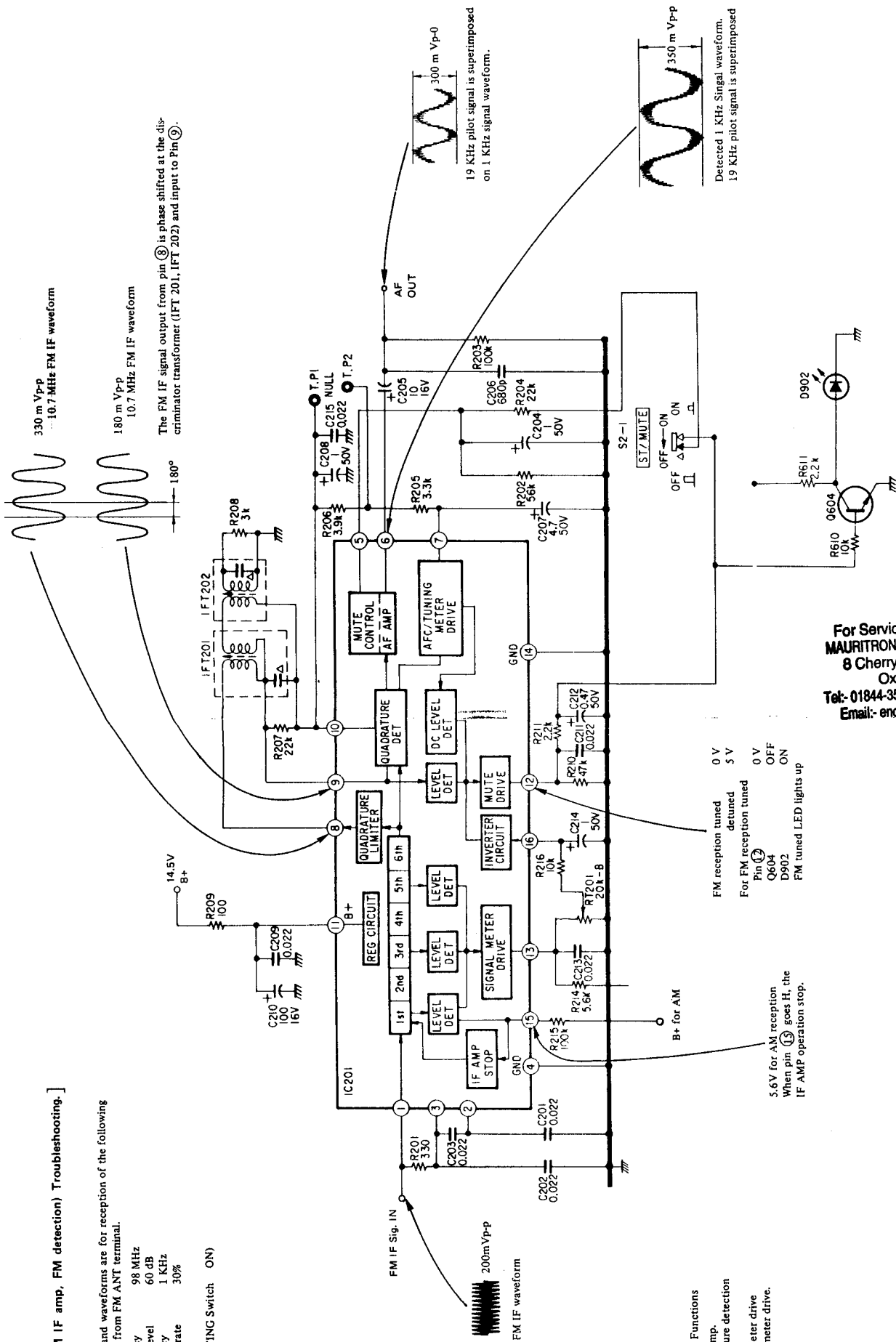

Main IC201 Functions
 FM IF amp.
 Quadrature detection
 Muting
 Signal Meter drive
 Tuning meter drive.

0 V
 5 V
 0 V
 0 V
 OFF
 ON
 For FM reception tuned
 For FM reception tuned
 Pin 1
 Q604
 D902
 FM tuned LED lights up

5.6V for AM reception
 When pin 13 goes H, the
 IF AMP operation stop.

For Service Manuals Contact
MAURITRON TECHNICAL SERVICES
 8 Cherry Tree Rd, Chinnor
 Oxon OX9 4QY
 Tel: 01844-351694 Fax: 01844-352554
 Email: enquiries@maurtron.co.uk

[IC 301 (Stereo demodulation) troubleshooting]

Voltage values and waveforms are for reception of the following FM signal input from FM ANT terminal.

- RF frequency 98 MHz
- RF output 60 dB
- AF frequency 1 KHz
- Modulation rate 30%
- R + L STEREO (STEREO/MUTING Switch ON)

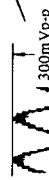
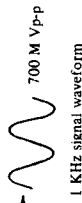

19 KHz pilot signal is superimposed on 1 KHz signal waveform.

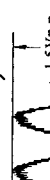

19 KHz pilot signal is superimposed on 1 KHz signal waveform.



76 KHz VCO Oscillation Waveform

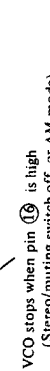

19 KHz pilot signal is superimposed on the 1 KHz signal waveform. This pilot signal is phase compared to the VCO signal inside the IC.

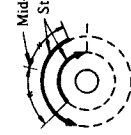

Easy VCO adjustment method

1. Receive FM stereo signal.
2. Turn RT301 right and left, and set at the mid-point of the areas where the stereo lamp is lit up overlap.

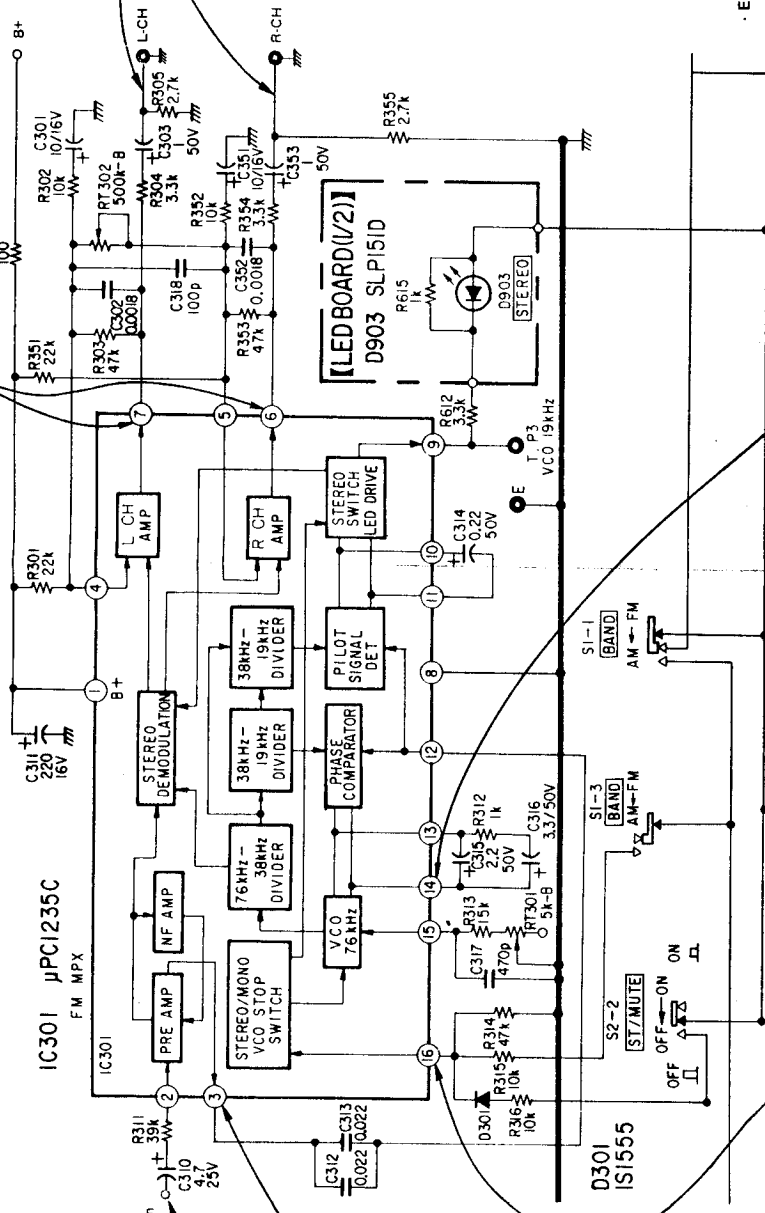

- Main-IC 301 Functions
- Input pre-amp
- PLL section (76 KHz VCO, phase comparator, LPF frequency divider, DC-AMP)
- Stereo demodulation
- Output amp.
- Stereo lamp drive
- VCO Stop switch

VCO stops when pin 16 is high (Stereo/muting switch off, or AM mode). (VCO Stops when DC voltage is more than 7 V.)

NOTE: Easy check for AM reception sensitivity
 INPUT a 650 KHz AM Signal from AM ANT terminal using AM SSG.
 Receive AM SSG Signal.
 IC 401 PIN ⑦ IF Voltage.

Output	Voltage
50dB	120mVp-p
55dB	200mVp-p

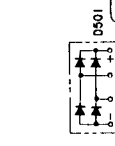

Voltage, Waveform	Defective Part
MW: 800mVp-p LW: 800mVp-p	IC 401, C402 C409 ~ C411 C417 ~ C419 R404 ~ R407 R412

Detected Signal waveform.
 1 KHz Signal has IF wave superimposed.

With AM SSG, input an AM signal from AM ANT. terminal.

Mode	Frequency	Output
MW	650KHz	60dB
LW	250KHz	60dB

Receive AM SSG signal. (MUTING: OFF)

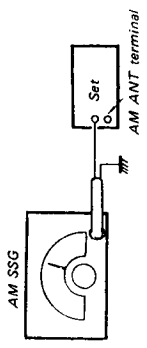

Voltage, Waveform	Defective Part
MW: 75mVp-p LW: 75mVp-p IF Waveform	IC 401

Voltage, Waveform	Defective Part
MW: 55mVp-p LW: 55mVp-p IF Waveform	IFT 401 CF 401 C 408

Voltage, Waveform	Defective Part
MW: 330mVp-p LW: 350mVp-p IF Waveform	IC401, CT404, L901 S1, CV2, C407
MW: 1Vp-p LW: 1Vp-p	IC401, CT403, L901 S1, CV2, C407

Local oscillation waveform

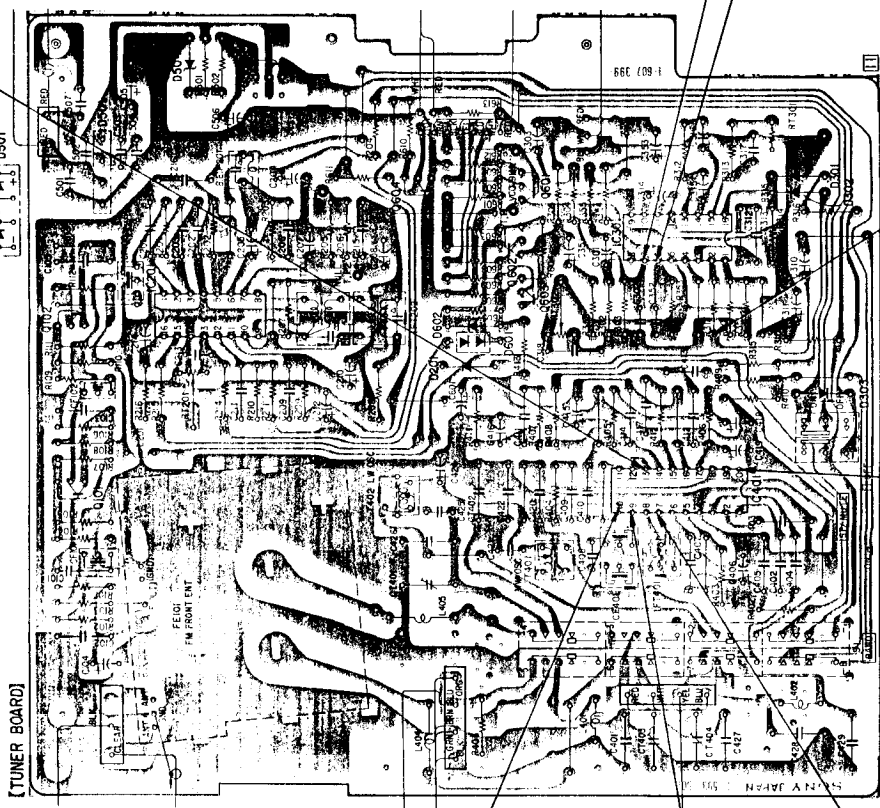

[TUNER BOARD]

Voltage	Defective Part
MW: 650mVp-p LW: 650mVp-p 1KHz Signal waveform	R304, R901, R902 C303, C902 L901
MW: 650mVp-p LW: 650mVp-p 1KHz Signal waveform	R354, R903, R904 C353, C903 L902

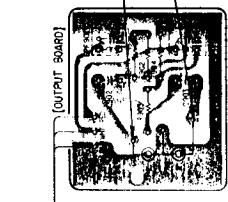

Voltage, Waveform	Defective Part
MW: 650mVp-p LW: 650mVp-p 1 KHz Singal. Waveform.	R304, R305 L C303
MW: 650mVp-p LW: 650mVp-p 1 KHz Singal. Waveform.	R354, R355 R C353,

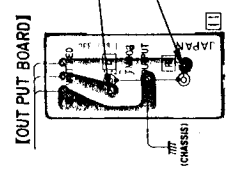

Voltage, Waveform	Defective Part
MW: 1.2Vp-p LW: 1.2Vp-p 1 KHz Signal Waveform	IC301, D302, R314, S1 L RT302, R301~R303 C318, C301, C302
MW: 1.2Vp-p LW: 1.2Vp-p 1 KHz Signal Waveform	IC301, D302, R314, S1 R RT302, R351~R353 C318, C351, C352

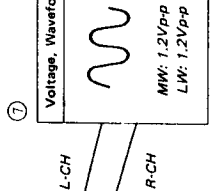

Voltage, Waveform	Defective Part
MW: 220mVp-p LW: 220mVp-p 1 KHz Signal Waveform.	R408 ~ R410 C412, C413, C310 S1.

Voltage, Waveform	Defective Part
MW: 1Vp-p LW: 1Vp-p Local oscillation waveform	IC401, T401, CT402 CV4, S1
MW: 1Vp-p LW: 1Vp-p Local oscillation waveform	IC401, T402, CT401 CV4, S1

Voltage, Waveform	Defective Part
MW: 330mVp-p LW: 350mVp-p IF Waveform	IC401, CT404, L901 S1, CV2, C407
MW: 1Vp-p LW: 1Vp-p	IC401, CT403, L901 S1, CV2, C407

Local oscillation waveform

For Service Manuals Contact
MAURITRON TECHNICAL SERVICES
 8 Cherry Tree Rd, Chinnor
 Oxon OX9 4QY
 Tel: 01844-351694 Fax: 01844-352554
 Email: enquiries@mauritron.co.uk

(MEMO)

For Service Manuals Contact
MAURITRON TECHNICAL SERVICES
8 Cherry Tree Rd, Chinnor
Oxon OX9 4QY
Tel: 01844-351694 Fax: 01844-352554
Email: enquiries@maurtron.co.uk