

ST-JX311/JX411

SERVICE MANUAL

*US Model
Canadian Model
E Model
Australian Model*



Photo: ST-JX411

ST-JX311: This set is the tuner section in SEN-311.

SPECIFICATIONS

FM tuner section

Tuning range	87.5 – 108 MHz
Antenna terminals	75 ohms unbalanced 300 ohms balanced
Intermediate frequency	10.7 MHz
Sensitivity (at 50 dB quieting)	22.1 dBf, 7 μ V (mono), 42.1 dBf, 70 μ V (stereo)
Usable sensitivity	19.5 dBf, 5 μ V (IHF)
Signal-to-noise ratio (at 75 kHz deviation)	80 dB (mono), 75 dB (stereo)
Harmonic distortion	0.3% (mono), 0.5% (stereo) at 1 kHz
Separation	40 dB at 1 kHz
Frequency response	30 Hz – 15 kHz ± 3 dB
Selectivity	55 dB at 400 kHz
AM suppression ratio	54 dB
Image response ratio	50 dB
IF response ratio	90 dB
Spurious response ratio	70 dB
Automatic tuning threshold	17.8 μ V (30 dBf)
Output	775 mV, 4.7 kohms (at 75 kHz deviation)

AM tuner section

Tuning range	US, Canadian model: 530–1,710 kHz (10 kHz) 531–1,710 kHz (9 kHz) E, Australian model: 531–1,602 kHz
Antenna	AM loop antenna, External antenna terminal
Intermediate frequency	450 kHz
Usable sensitivity	AM loop antenna: 500 μ V/m (999 kHz or 1,000 kHz)
Signal-to-noise ratio	54 dB

Harmonic distortion	0.5%
Selectivity	35 dB (9 kHz) 38 dB (10 kHz)

General

Power requirements	US, Canadian model: 120 V AC, 60 Hz E, Australian model: 240 V AC, 50 Hz
Power consumption	8 W (ST-JX411)
AC outlet (U.S.A. model only)	1 unswitched, 120W/1 A max.
Dimensions	Approx. 430 x 80 x 295 mm (w/h/d) (17 x 3 $\frac{1}{4}$ x 11 $\frac{5}{8}$ inches)
Weight	ST-JX311: Approx. 2.1 kg (4 lb 11 oz) ST-JX411: Approx. 2.6 kg (5 lb 12 oz)
Accessories supplied	ST-JX311: Flat cord with 11-5-5-pin connectors (1), connected to TC-W311. Flat cord with 9-9-pin connectors (1) Remote commander RM-S102 (1) Sony batteries SUM 3 (NS) (2)
ST-JX411:	Remote control cord (1) Audio connecting cord (1) AM loop antenna (1) FM loop antenna (1)

Design and specifications subject to change without notice.

FM STEREO/FM-AM TUNER
SONY®

SAFETY CHECK-OUT

After correcting the original service problem, perform the following safety check before releasing the set to the customer:

Check the antenna terminals, metal trim, "metallized" knobs, screws, and all other exposed metal parts for AC leakage. Check leakage as described below.

LEAKAGE TEST

The AC leakage from any exposed metal part to earth ground and from all exposed metal parts to any exposed metal part having a return to chassis, must not exceed 0.5 mA (500 microamperes). Leakage current can be measured by any one of three methods.

1. A commercial leakage tester, such as the Simpson 229 or RCA WT-540A. Follow the manufacturers' instructions to use these instruments.
2. A battery-operated AC milliammeter. The Data Precision 245 digital multimeter is suitable for this job.
3. Measuring the voltage drop across a resistor by means of a VOM or battery-operated AC voltmeter. The "limit" indication is 0.75 V, so analog meters must have an accurate low-voltage scale. The Simpson 250 and Sanwa SH-63Trd are examples of a passive VOM that is suitable. Nearly all battery operated digital multimeters that have a 2 V AC range are suitable. (See Fig. A)

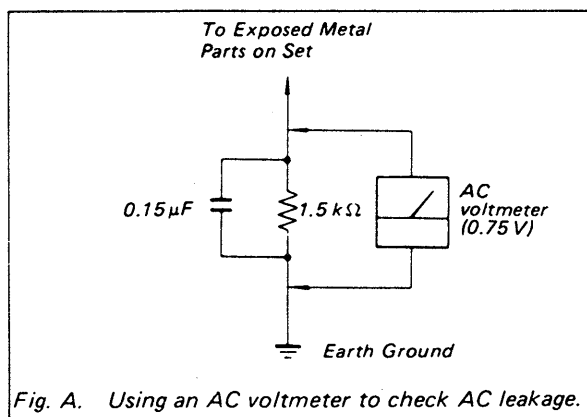

Fig. A. Using an AC voltmeter to check AC leakage.

SAFETY-RELATED COMPONENT WARNING!!



COMPONENTS IDENTIFIED BY MARK  OR DOTTED LINE WITH MARK  ON THE SCHEMATIC DIAGRAMS AND IN THE PARTS LIST ARE CRITICAL TO SAFE OPERATION. REPLACE THESE COMPONENTS WITH SONY PARTS WHOSE PART NUMBERS APPEAR AS SHOWN IN THIS MANUAL OR IN SUPPLEMENTS PUBLISHED BY SONY.

TABLE OF CONTENTS

<u>Section</u>	<u>Title</u>	<u>Page</u>
Specifications	1
Safety Check-out	2
SECTION 1. GENERAL		
1-1.	Location of Controls	3
1-2.	Connections	4
SECTION 2. ELECTRICAL ADJUSTMENTS		
SECTION 3. DIAGRAMS		
3-1.	Printed Wiring Boards	7
3-2.	Schemartic Diagram (Tuner Section)	11
3-3.	Semiconductor Lead Layouts	13
3-4.	Waveforms	13
3-5.	Schematic Diagram (Control and Power Section)	14
SECTION 4. EXPLODED VIEW		
SECTION 5. ELECTRICAL PARTS LIST		

To change the AM tuning interval

The AM tuning interval is preset at the factory to 10 kHz to match the frequency allocation system of your country. To change the interval to 9 kHz, proceed as follows.

- 1 Depress the POWER switch to turn on the unit.
- 2 Set the BAND FM/AM selector to AM.
- 3 Press the POWER switch to turn off the unit.
- 4 Hold the TUNING knob in the "+" position, and depress the POWER switch to turn on the unit. To reset the interval to 10 kHz, follow the same procedure.

Note

When the interval is changed, all preset stations which you have memorized using the numeric buttons will be erased from the memory. After changing the interval, be sure to preset the stations again.

ATTENTION AU COMPOSANT AYANT RAPPORT À LA SÉCURITÉ!

LES COMPOSANTS IDENTIFIÉS PAR UNE MARQUE  SUR LES DIAGRAMMES SCHÉMATIQUES ET LA LISTE DES PIÈCES SONT CRITIQUES POUR LA SÉCURITÉ DE FONCTIONNEMENT. NE REMPLACER CES COMPOSANTS QUE PAR DES PIÈCES SONY DONT LES NUMÉROS SONT DONNÉS DANS CE MANUEL OU DANS LES SUPPLÉMENTS PUBLIÉS PAR SONY.

SECTION 1 GENERAL

This section is extracted from instruction manual.

1-1. LOCATION OF CONTROLS

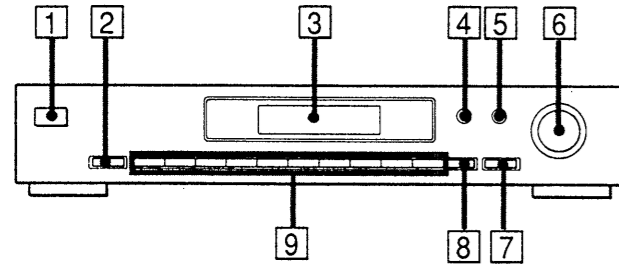

- 1 POWER switch (ST-JX411 only)
- 2 SHIFT button
- 3 Display window
- 4 MEMORY SCAN button
- 5 AUTO TUNING button
- 6 TUNING control
- 7 BAND FM/AM selector
- 8 MEMORY button
- 9 Numeric buttons

1-2. CONNECTION

- Connect the AC power cord last. Make sure power is off.
- Cord plugs and jacks are color coded. Red plugs and jacks are for right channel (R) and white ones for the left channel (L).
- The cable connectors should be fully inserted into the jacks. A loose connection may cause hum and noise.
- Keep speaker cords, connecting cords and power cords away from the AM loop antenna and the tuner's antenna lead-in to avoid possible noise pickup.

CAUTION
Do not put anything like another unit to obstruct the ventilation holes on the top of the amplifier.
The level surface installation is required for essential air ventilation to prevent internal heat built up in the amplifier.

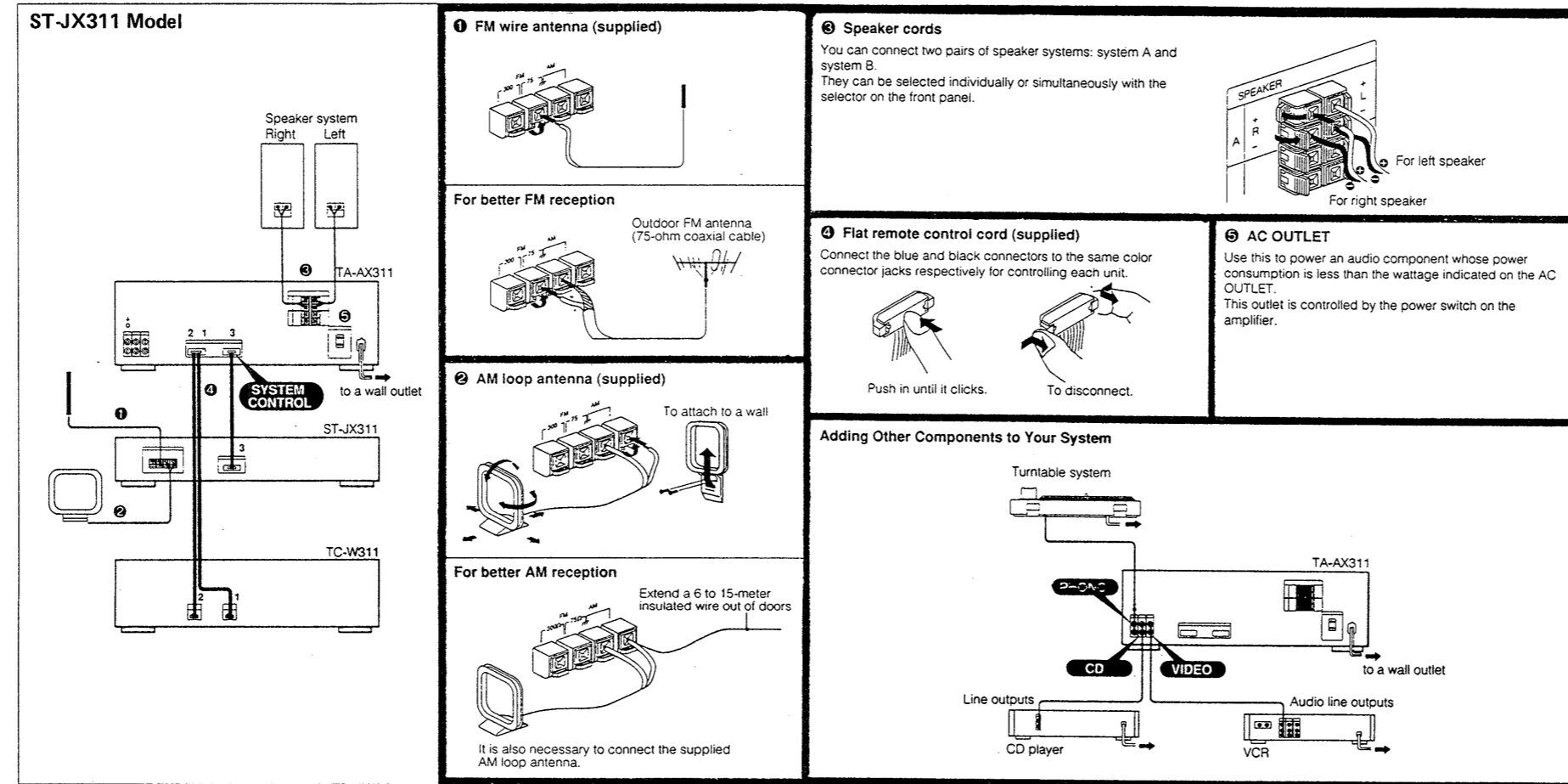

CAUTION
Do not connect any electrical home appliances such as an iron, fan, TV or other high wattage equipment to the AC OUTLET.

Note
The supplied flat cords for tape deck are already connected to the TC-W311.

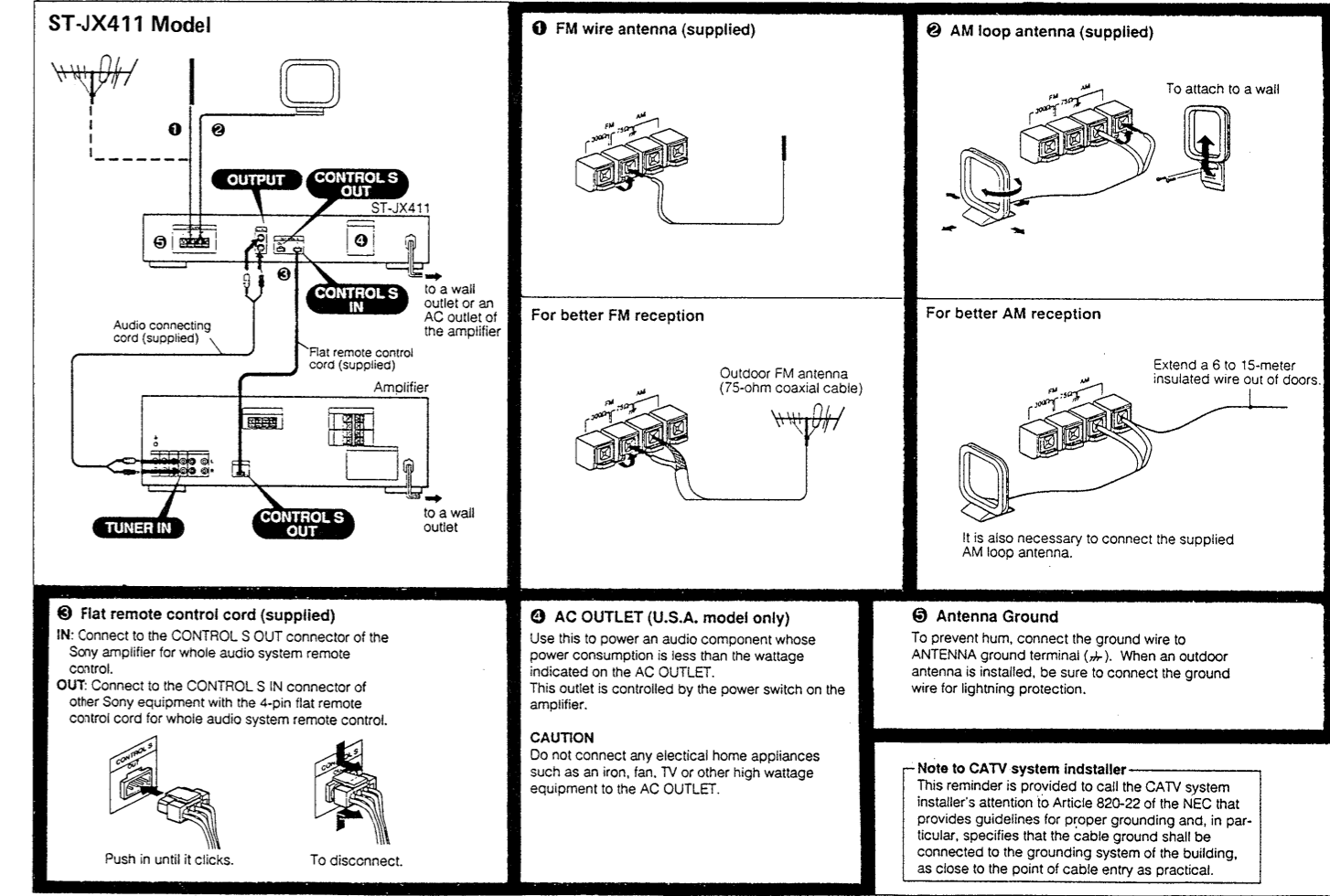

AC OUTLET (U.S.A. model only)
Use this to power an audio component whose power consumption is less than the wattage indicated on the AC OUTLET. This outlet is controlled by the power switch on the amplifier.

CAUTION
Do not connect any electrical home appliances such as an iron, fan, TV or other high wattage equipment to the AC OUTLET.

Note to CATV system installer
This reminder is provided to call the CATV system installer's attention to Article 820-22 of the NEC that provides guidelines for proper grounding and, in particular, specifies that the cable ground shall be connected to the grounding system of the building, as close to the point of cable entry as practical.

SECTION 2 ELECTRICAL ADJUSTMENTS

FM SECTION

• FM Discriminator Alignment (NULL check)

Setting :

FM RF stereo signal generator

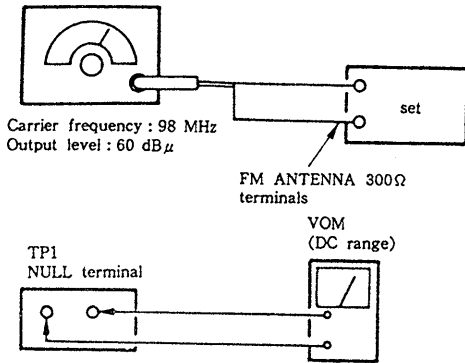

Procedure :

1. Tune the set to 98 MHz.
2. Adjust T21 for 0 V reading on the VOM.

Note : FM TUNING LEVEL adjustment should be made after FM discriminator alignment.

• FM TUNING LEVEL Adjustment

Setting :

FM RF stereo signal generator

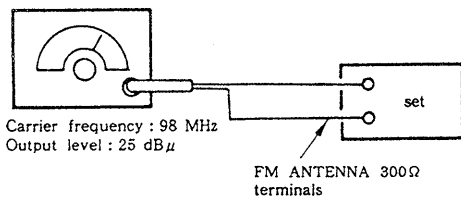

Procedure :

1. Tune the set to 98 MHz.
2. Adjust RV24 so that the TUNED LED goes on.

• FM Stereo Separation Adjustment

Setting :

FM RF stereo signal generator

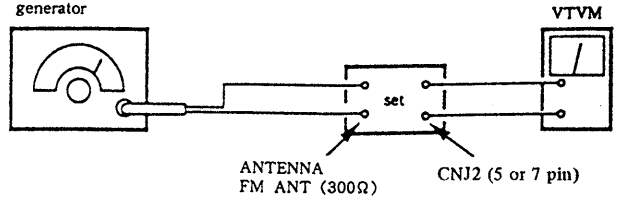

Procedure :

Tune the set to 98 MHz.

FM stereo signal generator output channel	VTVM connection	VTVM reading (dB)
L-CH	L-CH	(A)
R-CH	L-CH	(B) Adjust RV21 for minimum reading.
R-CH	R-CH	(C)
L-CH	R-CH	(D) Adjust RV21 for minimum reading.

L-CH Stereo separation : (A) - (B)
R-CH Stereo separation : (C) - (D)

The separations of both channels should be equal.

AM SECTION

• AM Tuned Indication Lighting Level Adjustment

Setting :

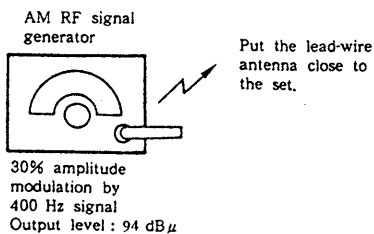

Procedure :

1. Tune the set to 1,050 kHz (US, CANADIAN), 999 kHz (E, AUS).
2. Adjust RV22 so that the TUNED LED goes on.

- TUNER BOARD - (Component side)

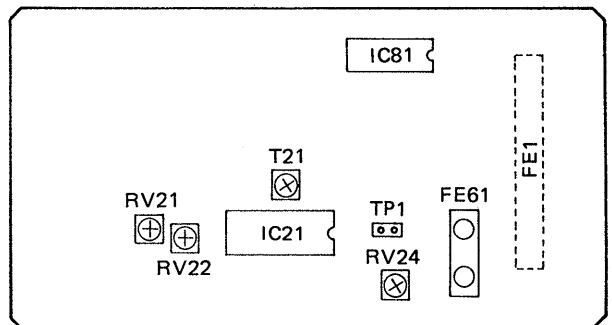

**SECTION 3
DIAGRAMS**

3-1. PRINTED WIRING BOARDS

- Note:**
- : parts extracted from the component side.
 - : indicates side identified with part number.
 - ▨ : Pattern on the side which is seen.

[Note on Inserting the Cord to the Connector on Tuner Board]

- Insert the cord to the connector fitting Pin ① of the cord in accordance with the white mark on the board at the connector as shown in the figure.

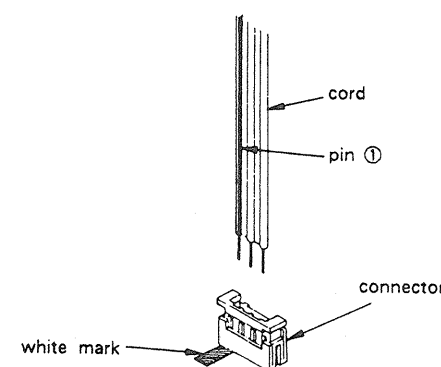

● Semiconductor Location

Ref. No.	Location	Ref. No.	Location
D21	H-5	D714	C-3
D22	H-6	D715	C-5
D23	H-6	D716	C-5
D24	H-6	D717	B-4
D501	G-17	D718	B-4
D502	G-17		
D503	G-16	IC21	J-5
D504	H-16	IC81	H-4
D505	I-17	IC501	F-18
D506	H-17	IC701	B-8
D507	F-16		
D601	I-9	Q1	I-3
D602	I-12	Q21	H-7
D603	I-10	Q22	H-7
D701	B-12	Q26	I-6
D702	B-10	Q27	I-7
D703	C-13	Q28	H-6
D707	C-6	Q81	H-4
D708	C-5	Q82	I-4
D709	C-5	Q83	H-5
D710	C-3	Q84	H-3
D711	C-3	Q601	I-10
D712	C-3	Q602	I-10
D713	B-3		

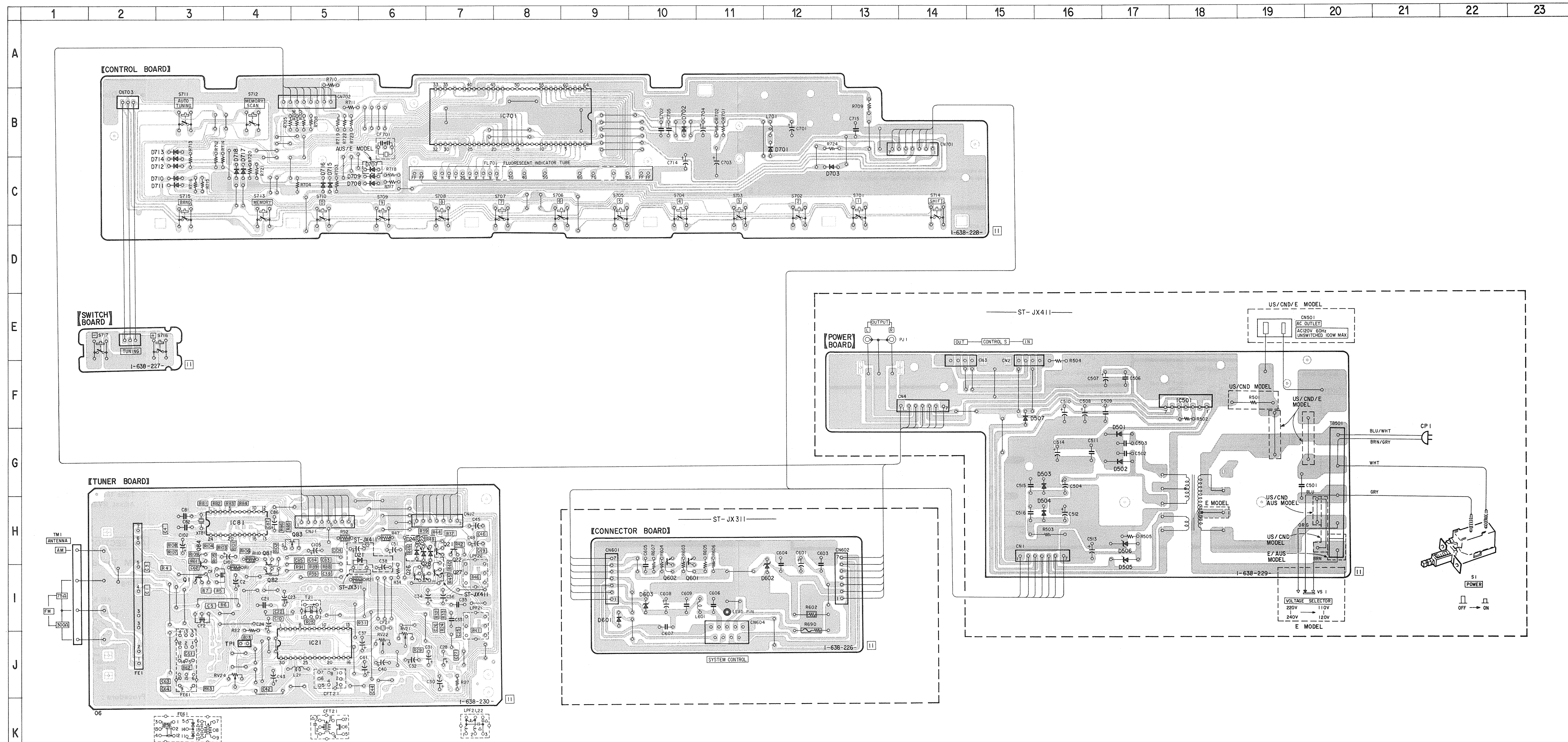

3-3. SEMICONDUCTOR LEAD LAYOUTS

EQA02-06C
1N4148M
10E2N

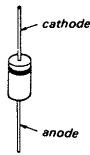

HZS6A3L
RD30ESB3

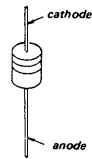

LA5667

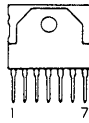

DTC114ES
2SC2603-EF
2SC3113-AB
2SC2669-OY



2SK246GR3



2SC2785-HFE

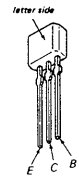

Note:

- All capacitors are in μF unless otherwise noted. pF : $\mu\mu\text{F}$
50WV or less are not indicated except for electrolytics and tantalums.
- All resistors are in Ω and $1/4\text{W}$ or less unless otherwise specified.
- \triangle : internal component.
- : nonflammable resistor.
- : fusible resistor.

Note:

The components identified by mark \triangle or dotted line with mark \triangle are critical for safety. Replace only with part number specified.

Note:

Les composants identifiés par une marque \triangle sont critiques pour la sécurité. Ne les remplacer que par une pièce portant le numéro spécifié.

- Voltage and waveforms are dc with respect to ground under no-signal (detuned) conditions.
- no mark : FM
- Voltages are taken with a VOM. (Input impedance $10\text{M}\Omega$) Voltage variations may be noted due to normal production tolerances.
- Waveforms are taken with a oscilloscope. Voltage variations may be noted due to normal production tolerances.
- Circled numbers refer to waveforms.
- Signal path.
 \Rightarrow : FM

- : B+ line.
- : B- line.
- : adjustment for repair.

3-4. WAVEFORMS

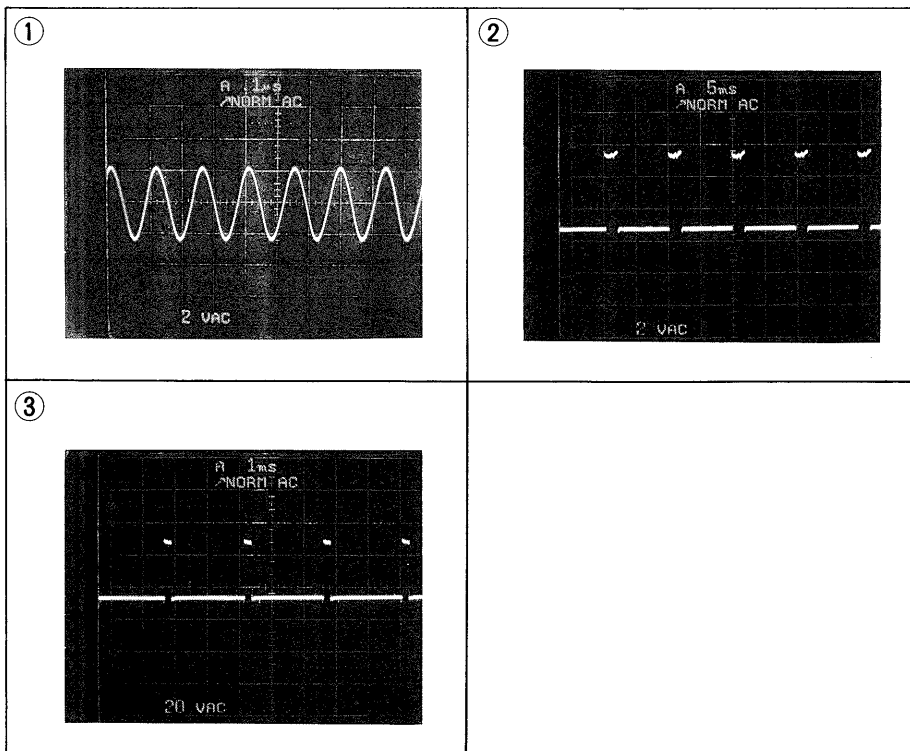

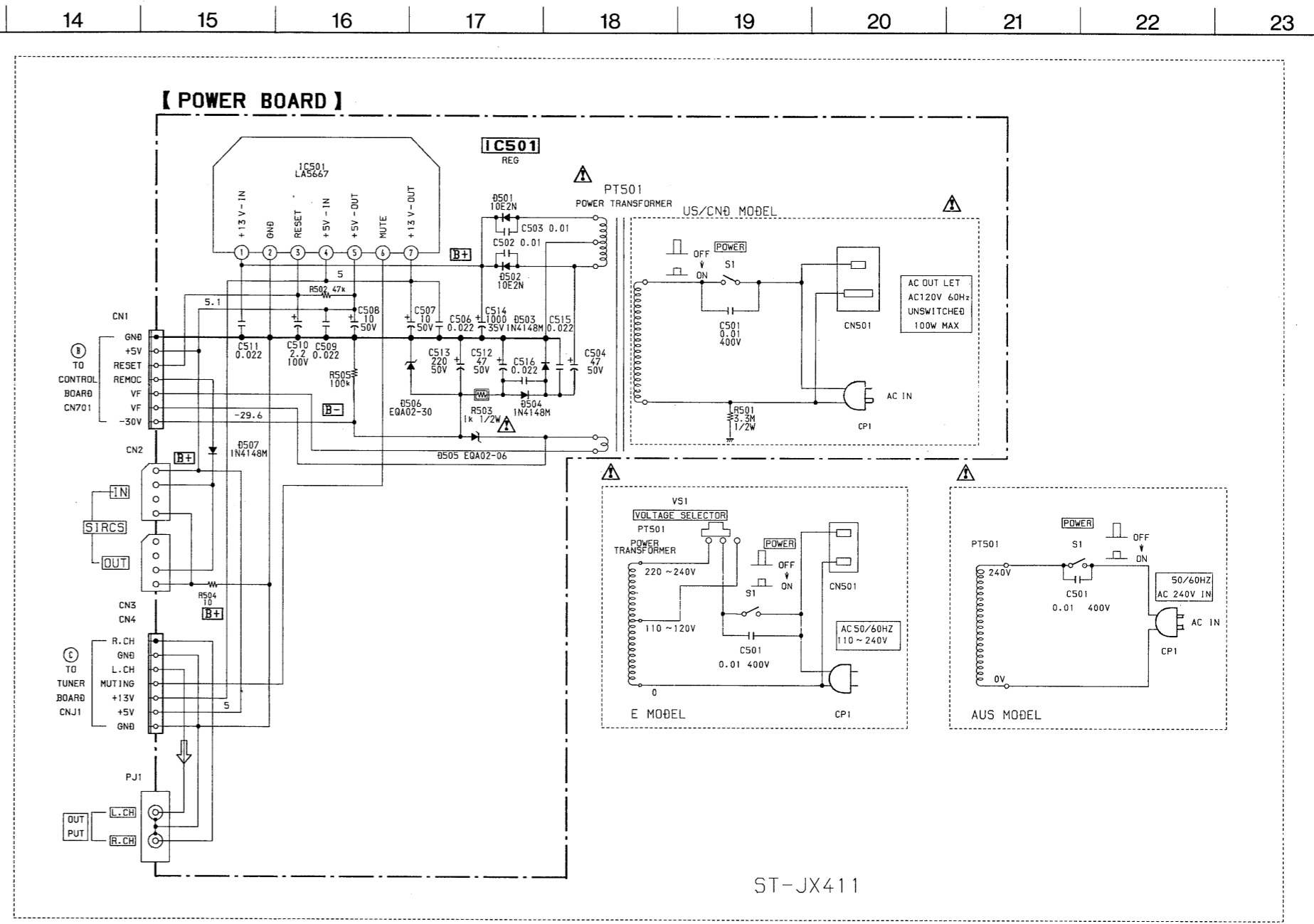
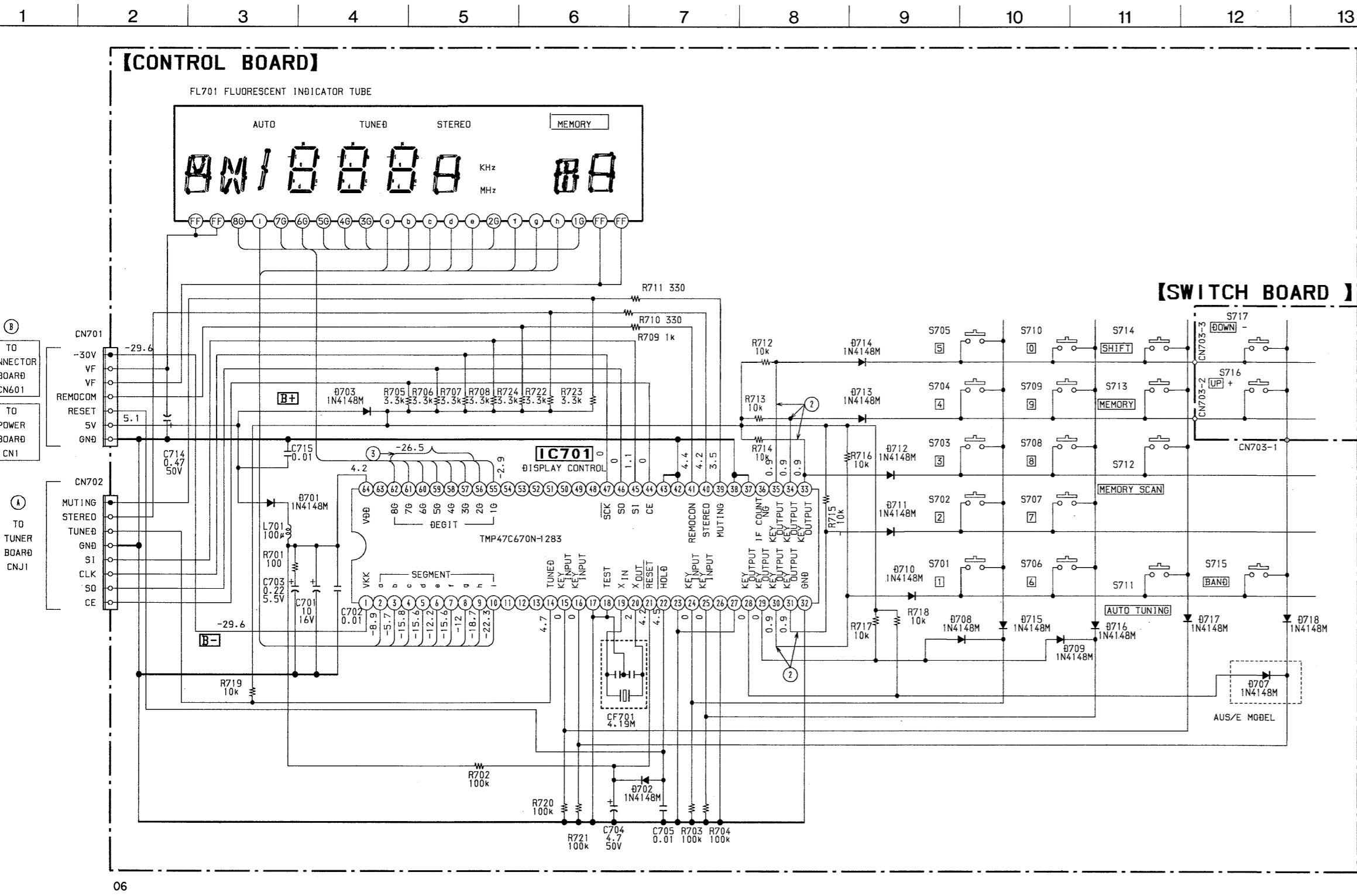

ST-JX411

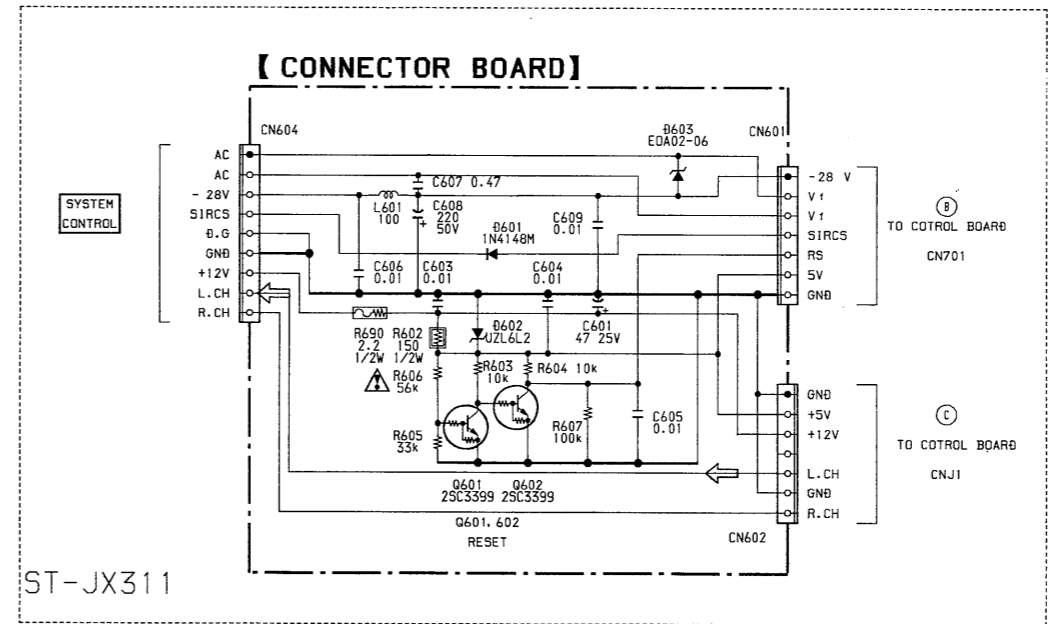

ST-JX311

Ref.No.	Part No.	Description	Remark
1	4-943-466-01	KNOB (TUNING)	
2	4-946-017-01	SPRING, RING	
3	A-4323-885-A	PANEL ASSY, FRONT (JX311:US, Canadian)	
3	A-4323-886-A	PANEL ASSY, FRONT (JX311:E, AUS)	
3	A-4323-888-A	PANEL ASSY, FRONT (JX411:US)	
3	A-4323-889-A	PANEL ASSY, FRONT (JX411:E, AUS)	
3	A-4325-040-A	PANEL ASSY, FRONT (JX411:Canadian)	
4	X-4905-269-1	SHAFT ASSY, TUNING	
6	4-928-635-01	SCREW, +BV (2.6X8) TAPPING	
9	A-4341-787-A	CONTROL BOARD, COMPLETE (JX411:US)	
9	A-4341-788-A	CONTROL BOARD, COMPLETE (JX411:Canadian)	
9	A-4341-789-A	CONTROL BOARD, COMPLETE (JX411:E)	
9	* A-4341-790-A	CONTROL BOARD, COMPLETE (JX411:AUS)	
10	4-917-460-41	KNOB, POWER (JX411)	
11	3-704-366-01	SCREW (CASE) (M3X8)	
12	4-923-457-01	CASE	
13	3-318-688-51	FOOT (F58175S) (JX411:Canadian)	
13	X-4941-228-1	FOOT ASSY (JX411:US, E, AUS)	
14	* 3-346-265-11	HOLDER, PC BOARD	
15	* A-4341-783-A	TUNER BOARD, COMPLETE (JX311:US, Canadian)	
15	* A-4341-793-A	TUNER BOARD, COMPLETE (JX311:E, AUS)	
15	* A-4341-794-A	TUNER BOARD, COMPLETE (JX411:US, Canadian)	
15	* A-4341-795-A	TUNER BOARD, COMPLETE (JX411:E, AUS)	
16	* 1-638-229-11	POWER BOARD (JX411)	
17	* 4-943-471-01	PANEL, BACK (JX411:US, Canadian)	
17	* 4-943-471-11	PANEL, BACK (JX411:E)	
17	* 4-943-471-21	PANEL, BACK (JX411:AUS)	
17	* 4-943-472-01	PANEL, BACK (JX311:US, Canadian, AUS)	
17	* 4-943-472-11	PANEL, BACK (JX311:E)	

Ref.No.	Part No.	Description	Remark
18	* 3-703-244-00	BUSHING (2104), CORD (JX411:AUS)	
18	* 3-703-571-11	BUSHING (S) (4516), CORD (JX411:US, Canadian, E)	
19	1-569-007-11	ADAPTER, CONVERSION 2P (JX411:E)	
20	* 1-638-226-11	CONNECTOR BOARD (JX311)	
21	3-704-242-01	SCREW, TERMINAL, + BVTP CLAW (JX311)	
22	4-923-836-21	CUSHION (JX411: Canadian)	
CN501	△ 1-540-057-11	OUTLET, AC (POLAR) (AC OUTLET) (JX411:US, Canadian)	
CN501	△ 1-540-038-11	OUTLET, AC (NONPOLAR) (1P) (JX411:E)	
CN604	1-565-949-11	SOCKET, CONNECTOR 9P (JX311:US, Canadian, E, AUS)	
CP1	△ 1-551-188-XX	CORD, POWER (JX411:E)	
CP1	△ 1-558-945-11	CORD, POWER (JX411:US, Canadian)	
CP1	△ 1-559-912-11	CORD, POWER (JX411:AUS)	
FL701	1-519-512-11	INDICATOR TUBE, FLUORESCENT	
PJ1	* 1-580-691-11	JACK, PIN 2P (JX411)	
PT501	△ 1-450-386-11	TRANSFORMER, POWER (JX411:AUS, E)	
PT501	△ 1-450-387-11	TRANSFORMER, POWER (JX411:US, Canadian)	
S1	△ 1-572-267-21	SWITCH, PUSH (AC POWER) (1 KEY) (JX411)	
TM1	* 1-537-264-11	TERMINAL BOARD	
VS1	△ 1-570-046-21	SWITCH, VOLTAGE CHANGE (JX411:E)	

Note:

The components identified by mark △ or dotted line with mark △ are critical for safety. Replace only with part number specified.

Note:

Les composants identifiés par une marque △ sont critiques pour la sécurité. Ne les remplacer que par une pièce portant le numéro spécifié.

CONTROL**SWITCH****CONNECTOR****SECTION 5
ELECTRICAL PARTS LIST****NOTE:**

- Due to standardization, replacements in the parts list may be different from the parts specified in the diagrams or the components used on the set.
- -XX, -X mean standardized parts, so they may have some difference from the original one.
- **RESISTORS**
All resistors are in ohms
METAL: Metal-film resistor
METAL OXIDE: Metal Oxide-film resistor
F: nonflammable

- Items marked "*" are not stocked since they are seldom required for routine service. Some delay should be anticipated when ordering these items.
- **SEMICONDUCTORS**
In each case, u: μ , for example:
uA...: μ A..., uPA...: μ PA...,
uPB...: μ PB..., uPC...: μ PC...,
uPD...: μ PD...
- **CAPACITORS**
uF: μ F
- **COILS**
uH: μ H

The components identified by mark Δ or dotted line with mark Δ are critical for safety. Replace only with part number specified.

Les composants identifiés par une marque Δ sont critiques pour la sécurité. Ne les remplacer que par une pièce portant le numéro spécifié.

- Abbreviation
AUS: Australian

Ref. No.	Part No.	Description	Remark
	A-4341-787-A	CONTROL BOARD, COMPLETE (JX311:US, Canadian/JX411:US)	
	A-4341-788-A	CONTROL BOARD, COMPLETE (JX411:Canadian)	
	A-4341-789-A	CONTROL BOARD, COMPLETE (JX311:E, AUS/JX411:E)	
*	A-4341-790-A	CONTROL BOARD, COMPLETE (JX411:AUS) *****	
	1-638-227-11	SWITCH BOARD	
*	1-638-226-11	CONNECTOR BOARD (JX311)	
*	4-921-941-01	CUSHION (FL)	
*	4-942-301-01	HOLDER, FL TUBE	
< CAPACITOR >			
C601	1-124-477-11	ELECT 47uF 20% 25V (JX311)	
C603	1-101-004-00	CERAMIC 0.01uF 50V (JX311)	
C604	1-101-004-00	CERAMIC 0.01uF 50V (JX311)	
C605	1-101-004-00	CERAMIC 0.01uF 50V (JX311)	
C606	1-101-004-00	CERAMIC 0.01uF 50V (JX311)	
C607	1-136-173-00	FILM 0.47uF 5% 50V (JX311)	
C608	1-124-911-11	ELECT 220uF 20% 50V (JX311)	
C609	1-101-004-00	CERAMIC 0.01uF 50V (JX311)	
C701	1-126-157-11	ELECT 10uF 20% 16V	
C702	1-161-379-00	CERAMIC 0.01uF 20% 25V	
C703	1-125-486-11	DUBLE LAYERS 0.22F 5.5V	
C704	1-126-163-11	ELECT 4.7uF 20% 50V	
C705	1-161-379-00	CERAMIC 0.01uF 20% 25V	
C714	1-124-465-00	ELECT 0.47uF 20% 50V	
C715	1-161-379-00	CERAMIC 0.01uF 20% 25V	
< VIBRATOR >			
CF701	1-577-101-11	VIBRATOR, CERAMIC	

Ref. No.	Part No.	Description	Remark
< CONNECTOR >			
CN601	1-580-956-11	SOCKET, CONNECTOR 7P (JX311)	
CN602	1-580-956-11	SOCKET, CONNECTOR 7P (JX311)	
CN604	1-565-949-11	SOCKET, CONNECTOR 9P (SYSTEM CONTROL) (JX311)	
CN701	1-580-956-11	SOCKET, CONNECTOR 7P	
CN702	1-580-957-11	SOCKET, CONNECTOR 8P	
CN703	* 1-568-952-11	PIN, CONNECTOR 3P	
< DIODE >			
D601	8-719-987-63	DIODE 1N4148M (JX311)	
D602	8-719-933-35	DIODE HZS6A3L (JX311)	
D603	8-719-912-81	DIODE EQA02-06C	
D701	8-719-987-63	DIODE 1N4148M	
D702	8-719-987-63	DIODE 1N4148M	
D703	8-719-987-63	DIODE 1N4148M	
D707	8-719-987-63	DIODE 1N4148M (JX311:E, AUS/JX411:E, AUS)	
D708	8-719-987-63	DIODE 1N4148M	
D709	8-719-987-63	DIODE 1N4148M	
D710	8-719-987-63	DIODE 1N4148M	
D711	8-719-987-63	DIODE 1N4148M	
D712	8-719-987-63	DIODE 1N4148M	
D713	8-719-987-63	DIODE 1N4148M	
D714	8-719-987-63	DIODE 1N4148M	
D715	8-719-987-63	DIODE 1N4148M	
D716	8-719-987-63	DIODE 1N4148M	
D717	8-719-987-63	DIODE 1N4148M	
D718	8-719-987-63	DIODE 1N4148M	
< FLUORESCENT INDICATOR >			
FL701	1-519-512-11	INDICATOR TUBE, FLUORESCENT	

CONTROL

SWITCH

CONNECTOR

POWER

Ref. No.	Part No.	Description	Remark
		< IC >	
IC701	8-759-234-35	IC TMP47C670N-1283	
		< COIL >	
L601	1-410-521-11	INDUCTOR 100uH (JX311)	
L701	1-410-521-11	INDUCTOR 100uH	
		< TRANSISTOR >	
Q601	8-729-900-89	TRANSISTOR DTC144ES (JX311)	
Q602	△ 8-729-900-89	TRANSISTOR DTC144ES (JX311)	
		< RESISTOR >	
R602	1-247-741-11	CARBON 150 5% 1/2W F (JX311)	
R603	1-249-429-11	CARBON 10K 5% 1/4W (JX311)	
R604	1-249-429-11	CARBON 10K 5% 1/4W (JX311)	
R605	1-249-435-11	CARBON 33K 5% 1/4W (JX311)	
R606	1-249-438-11	CARBON 56K 5% 1/4W (JX311)	
R607	1-249-441-11	CARBON 100K 5% 1/4W (JX311)	
R690	1-212-942-00	FUSIBLE 2.2 5% 1/2W F (JX311)	
R701	1-249-405-11	CARBON 100 5% 1/4W	
R702	1-249-441-11	CARBON 100K 5% 1/4W	
R703	1-249-441-11	CARBON 100K 5% 1/4W	
R704	1-249-441-11	CARBON 100K 5% 1/4W	
R705	1-249-423-11	CARBON 3.3K 5% 1/4W	
R706	1-249-423-11	CARBON 3.3K 5% 1/4W	
R707	1-249-423-11	CARBON 3.3K 5% 1/4W	
R708	1-249-423-11	CARBON 3.3K 5% 1/4W	
R709	1-249-417-11	CARBON 1K 5% 1/4W	
R710	1-249-411-11	CARBON 330 5% 1/4W	
R711	1-249-411-11	CARBON 330 5% 1/4W	
R712	1-249-429-11	CARBON 10K 5% 1/4W	
R713	1-249-429-11	CARBON 10K 5% 1/4W	
R714	1-249-429-11	CARBON 10K 5% 1/4W	
R715	1-249-429-11	CARBON 10K 5% 1/4W	
R716	1-249-429-11	CARBON 10K 5% 1/4W	
R717	1-249-429-11	CARBON 10K 5% 1/4W	
R718	1-249-429-11	CARBON 10K 5% 1/4W	
R719	1-249-429-11	CARBON 10K 5% 1/4W	
R720	1-249-441-11	CARBON 100K 5% 1/4W	
R721	1-249-441-11	CARBON 100K 5% 1/4W	
R722	1-249-423-11	CARBON 3.3K 5% 1/4W	
R723	1-249-423-11	CARBON 3.3K 5% 1/4W	
R724	1-249-423-11	CARBON 3.3K 5% 1/4W	
		< SWITCH >	
S701	1-554-303-21	SWITCH, TACTILE (1)	
S702	1-554-303-21	SWITCH, TACTILE (2)	
S703	1-554-303-21	SWITCH, TACTILE (3)	

Ref. No.	Part No.	Description	Remark
S704	1-554-303-21	SWITCH, TACTILE (4)	
S705	1-554-303-21	SWITCH, TACTILE (5)	
S706	1-554-303-21	SWITCH, TACTILE (6)	
S707	1-554-303-21	SWITCH, TACTILE (7)	
S708	1-554-303-21	SWITCH, TACTILE (8)	
S709	1-554-303-21	SWITCH, TACTILE (9)	
S710	1-554-303-21	SWITCH, TACTILE (0)	
S711	1-554-303-21	SWITCH, TACTILE (AUTO TUNING)	
S712	1-554-303-21	SWITCH, TACTILE (MEMORY SCAN)	
S713	1-554-303-21	SWITCH, TACTILE (MEMORY)	
S714	1-554-303-21	SWITCH, TACTILE (SHIFT)	
S715	1-554-303-21	SWITCH, TACTILE (BAND)	
S716	1-554-303-21	SWITCH, TACTILE (TUNING +)	
S717	1-554-303-21	SWITCH, TACTILE (TUNING -)	

	* 1-638-229-11	POWER BOARD (JX411)	

	7-685-646-79	SCREW +BVTP 3X8 TYPE2 N-S	
		< CAPACITOR >	
C501	1-161-744-00	CERAMIC 0.01uF 400V	
C502	1-101-004-00	CERAMIC 0.01uF 50V	
C503	1-101-004-00	CERAMIC 0.01uF 50V	
C504	1-124-910-11	ELECT 47uF 20% 50V	
C506	1-101-005-00	CERAMIC 22000PF 50V	
C507	1-124-907-11	ELECT 10uF 20% 50V	
C508	1-124-907-11	ELECT 10uF 20% 50V	
C509	1-101-005-00	CERAMIC 22000PF 50V	
C510	1-124-925-11	ELECT 2.2uF 20% 100V	
C511	1-101-005-00	CERAMIC 22000PF 50V	
C512	1-124-910-11	ELECT 47uF 20% 50V	
C513	1-124-911-11	ELECT 220uF 20% 50V	
C514	1-126-105-11	ELECT 1000uF 20% 35V	
C515	1-101-005-00	CERAMIC 22000PF 50V	
C516	1-101-005-00	CERAMIC 22000PF 50V	
		< CONNECTOR >	
CN1	1-580-956-11	SOCKET, CONNECTOR 7P (JX411)	
CN2	1-564-980-11	PIN, CONNECTOR 4P (CONTROL S IN)	
CN3	1-564-980-11	PIN, CONNECTOR 4P (CONTROL S OUT)	
CN4	1-580-956-11	SOCKET, CONNECTOR 7P	
CN501	△ 1-540-057-11	OUTLET, AC (POLAR) (AC OUTLET)	(JX411:US, Canadian)
CN501	△ 1-540-038-11	OUTLET, AC (NONPOLAR) (1P) (JX411:E)	

Note:
The components identified by mark △ or dotted line with mark △ are critical for safety. Replace only with part number specified.

Note:
Les composants identifiés par une marque △ sont critiques pour la sécurité. Ne les remplacer que par une pièce portant le numéro spécifié.

POWER

TUNER

Ref. No.	Part No.	Description	Remark
< DIODE >			
D501	8-719-200-77	DIODE 10E2N	
D502	8-719-200-77	DIODE 10E2N	
D503	8-719-987-63	DIODE 1N4148M	
D504	8-719-987-63	DIODE 1N4148M	
D505	8-719-912-81	DIODE EQA02-06C	
D506	8-719-110-73	DIODE RD30ESB3	
D507	8-719-987-63	DIODE 1N4148M	
< IC >			
IC501	8-759-820-09	IC LA5667	
< JACK PIN >			
PJ1	* 1-580-691-11	JACK, PIN 2P	
< TRANSFORMER >			
PT501	△ 1-450-386-11	TRANSFORMER, POWER (JX411:E, AUS)	
PT501	△ 1-450-387-11	TRANSFORMER, POWER (JX411:US, Canadian)	
< RESISTOR >			
R501	1-202-725-00	SOLID 3.3M 10% 1/2W (JX411:US, Canadian)	
R502	1-249-437-11	CARBON 47K 5% 1/4W	
R503	△ 1-247-752-11	CARBON 1K 5% 1/2W F	
R504	1-249-393-11	CARBON 10 5% 1/4W	
R505	1-249-441-11	CARBON 100K 5% 1/4W	
< BASE POST >			
TB501	* 1-535-141-00	BASE POST 22MM (10MM PITCH) 4P (JX411:US, Canadian)	

* A-4341-783-A TUNER BOARD, COMPLETE (JX311:US, Canadian)			
* A-4341-793-A TUNER BOARD, COMPLETE (JX311:E, AUS)			
* A-4341-794-A TUNER BOARD, COMPLETE (JX411:US, Canadian)			
* A-4341-795-A TUNER BOARD, COMPLETE (JX411:E, AUS)			

< CAPACITOR >			
C1	1-163-141-00	CERAMIC CHIP 0.001uF 5% 50V	
C2	1-124-477-11	ELECT 47uF 20% 25V	
C3	1-164-232-11	CERAMIC CHIP 0.01uF 50V	
C4	1-163-141-00	CERAMIC CHIP 0.001uF 5% 50V	
C5	1-164-232-11	CERAMIC CHIP 0.01uF 50V	
C10	1-163-037-11	CERAMIC CHIP 0.022uF 10% 25V	
C21	1-161-021-11	CERAMIC 0.047uF 10% 25V	
C22	1-164-232-11	CERAMIC CHIP 0.01uF 50V	
C23	1-124-477-11	ELECT 47uF 20% 25V	
C24	1-123-382-00	ELECT 3.3uF 20% 100V	
C25	1-164-232-11	CERAMIC CHIP 0.01uF 50V	

Ref. No.	Part No.	Description	Remark
C26	1-163-019-00	CERAMIC CHIP 0.0068uF 10% 50V	
C27	1-163-117-00	CERAMIC CHIP 100PF 5% 50V	
C28	1-124-903-11	ELECT 1uF 20% 50V	
C30	1-124-903-11	ELECT 1uF 20% 50V	
C31	1-124-902-00	ELECT 0.47uF 20% 50V	
C32	1-124-463-00	ELECT 0.1uF 20% 50V	
C33	1-130-482-00	MYLAR 0.0082uF 5% 50V (JX311:US, Canadian/JX411:US, Canadian)	
C33	1-130-481-00	MYLAR 0.0068uF 5% 50V (JX311:E, AUS/JX411:E, AUS)	
C34	1-123-382-00	ELECT 3.3uF 20% 100V	
C35	1-130-482-00	MYLAR 0.0082uF 5% 50V (JX311:US, Canadian/JX411:US, Canadian)	
C35	1-130-481-00	MYLAR 0.0068uF 5% 50V (JX311:E, AUS/JX411:E, AUS)	
C36	1-123-382-00	ELECT 3.3uF 20% 100V	
C37	1-124-907-11	ELECT 10uF 20% 50V	
C38	1-124-907-11	ELECT 10uF 20% 50V (JX411)	
C39	1-164-232-11	CERAMIC CHIP 0.01uF 50V	
C40	1-124-463-00	ELECT 0.1uF 20% 50V	
C41	1-124-927-11	ELECT 4.7uF 20% 100V	
C42	1-164-232-11	CERAMIC CHIP 0.01uF 50V	
C43	1-126-176-11	ELECT 220uF 20% 10V	
C44	1-164-232-11	CERAMIC CHIP 0.01uF 50V	
C45	1-123-382-00	ELECT 3.3uF 20% 100V	
C46	1-164-161-11	CERAMIC CHIP 0.0022uF 10% 100V	
C48	1-123-382-00	ELECT 3.3uF 20% 100V	
C49	1-164-161-11	CERAMIC CHIP 0.0022uF 10% 100V	
C51	1-124-477-11	ELECT 47uF 20% 25V	
C52	1-124-252-00	ELECT 0.33uF 20% 50V (JX411)	
C61	1-163-037-11	CERAMIC CHIP 0.022uF 10% 25V	
C62	1-163-037-11	CERAMIC CHIP 0.022uF 10% 25V	
C63	1-163-037-11	CERAMIC CHIP 0.022uF 10% 25V	
C64	1-163-037-11	CERAMIC CHIP 0.022uF 10% 25V	
C81	1-102-961-00	CERAMIC 27PF 5% 50V	
C82	1-102-961-00	CERAMIC 27PF 5% 50V	
C83	1-164-232-11	CERAMIC CHIP 0.01uF 50V	
C84	1-164-232-11	CERAMIC CHIP 0.01uF 50V	
C85	1-164-232-11	CERAMIC CHIP 0.01uF 50V	
C86	1-124-477-11	ELECT 47uF 20% 25V	
C87	1-164-232-11	CERAMIC CHIP 0.01uF 50V	
C101	1-124-925-11	ELECT 2.2uF 20% 100V	
C102	1-124-463-00	ELECT 0.1uF 20% 50V	
C103	1-164-232-11	CERAMIC CHIP 0.01uF 50V	
C104	1-164-232-11	CERAMIC CHIP 0.01uF 50V	
C105	1-124-477-11	ELECT 47uF 20% 25V	

Note:
The components identified by mark **△** or dotted line with mark **△** are critical for safety. Replace only with part number specified.

Note:
Les composants identifiés par une marque **△** sont critiques pour la sécurité. Ne les remplacer que par une pièce portant le numéro spécifié.

TUNER

Ref. No.	Part No.	Description	Remark	Ref. No.	Part No.	Description	Remark
		< FILTER >					
CF1	1-567-389-11	FILTER, CERAMIC		R6	1-216-037-00	METAL CHIP 330 5%	1/10W
CF2	1-567-389-11	FILTER, CERAMIC		R7	1-216-109-00	METAL CHIP 330K 5%	1/10W
CF21	1-577-075-11	OSCILLATOR, CERAMIC		R21	△ 1-249-404-00	CARBON 82 5%	1/4W
CFT21	1-404-853-11	TRANSFORMER, IF (CERAMIC FILTER)		R22	1-247-535-11	CARBON 8.2K 5%	1/4W (JX311:US, Canadian/JX411:US, Canadian)
		< CONNECTOR >		R22	1-249-462-11	CARBON 22K 5%	1/4W (JX311:E, AUS/JX411:E, AUS)
CNJ1	1-580-957-11	SOCKET, CONNECTOR 8P		R23	1-216-049-00	METAL CHIP 1K 5%	1/10W
CNJ2	1-580-956-11	SOCKET, CONNECTOR 7P		R24	1-216-085-00	METAL CHIP 33K 5%	1/10W
		< DIODE >		R25	1-216-071-00	METAL CHIP 8.2K 5%	1/10W
D21	8-719-987-63	DIODE 1N4148M (JX411)		R27	1-247-543-11	CARBON 18K 5%	1/4W
D22	8-719-987-63	DIODE 1N4148M (JX411)		R29	1-216-073-00	METAL CHIP 10K 5%	1/10W
D23	8-719-987-63	DIODE 1N4148M (JX411)		R31	1-216-041-00	METAL CHIP 470 5%	1/10W
D24	8-719-987-63	DIODE 1N4148M (JX411)		R32	1-216-073-00	METAL CHIP 10K 5%	1/10W
		< FRONT END >		R33	1-216-073-00	METAL CHIP 10K 5%	1/10W
FE1	1-465-006-11	FRONT END (FM) (2 GANG)		R34	1-247-553-11	CARBON 47K 5%	1/4W (JX311)
FE61	1-236-461-11	ENCAPSULATED COMPONENT		R34	1-247-721-11	CARBON 4.7K 5%	1/4W (JX411)
		< IC >		R35	1-216-089-00	METAL CHIP 47K 5%	1/10W
IC21	8-759-821-45	IC LA1851N		R37	1-216-109-00	METAL CHIP 330K 5%	1/10W
IC81	8-759-820-91	IC LC7218		R39	1-216-057-00	METAL CHIP 2.2K 5%	1/10W
		< COIL >		R40	1-216-055-00	METAL CHIP 1.8K 5%	1/10W
L21	1-410-494-11	INDUCTOR 1MMH		R41	1-216-067-00	METAL CHIP 5.6K 5%	1/10W
		< FILTER >		R42	1-216-109-00	METAL CHIP 330K 5%	1/10W
LPF21	1-235-164-00	FILTER, LOW PASS		R44	1-216-057-00	METAL CHIP 2.2K 5%	1/10W
LPF22	1-235-164-00	FILTER, LOW PASS		R45	1-216-055-00	METAL CHIP 1.8K 5%	1/10W
		< TRANSISTOR >		R46	1-216-067-00	METAL CHIP 5.6K 5%	1/10W
Q1	8-729-230-XX	TRANSISTOR 2SC2669-0Y		R47	△ 1-249-409-11	CARBON 220 5%	1/4W
Q21	8-729-119-78	TRANSISTOR 2SC2785-HFE		R48	1-216-097-00	METAL CHIP 100K 5%	1/10W (JX411)
Q22	8-729-119-78	TRANSISTOR 2SC2785-HFE		R49	1-216-097-00	METAL CHIP 100K 5%	1/10W (JX411)
Q26	8-729-900-80	TRANSISTOR DTC114ES		R61	1-216-097-00	METAL CHIP 100K 5%	1/10W
Q27	8-729-620-05	TRANSISTOR 2SC2603-EF (JX411)		R62	1-216-089-00	METAL CHIP 47K 5%	1/10W
Q28	8-729-620-05	TRANSISTOR 2SC2603-EF (JX411)		R63	1-216-009-00	METAL CHIP 22 5%	1/10W
Q81	8-729-900-61	TRANSISTOR DTA114ES		R81	1-216-049-00	METAL CHIP 1K 5%	1/10W
Q82	8-729-900-80	TRANSISTOR DTC114ES		R82	1-216-049-00	METAL CHIP 1K 5%	1/10W
Q83	8-729-202-67	TRANSISTOR 2SK246-GR3		R83	1-216-049-00	METAL CHIP 1K 5%	1/10W
Q84	8-729-230-93	TRANSISTOR 2SC3113-AB		R84	1-216-049-00	METAL CHIP 1K 5%	1/10W
		< RESISTOR >		R85	1-216-073-00	METAL CHIP 10K 5%	1/10W
R1	△ 1-249-409-11	CARBON 220 5%	1/4W	R86	1-216-049-00	METAL CHIP 1K 5%	1/10W
R4	1-216-013-00	METAL CHIP 33 5%	1/10W	R88	1-216-065-00	METAL CHIP 4.7K 5%	1/10W
R5	1-216-013-00	METAL CHIP 33 5%	1/10W	R89	1-216-049-00	METAL CHIP 1K 5%	1/10W
				R91	1-216-049-00	METAL CHIP 1K 5%	1/10W
				R92	△ 1-249-401-11	CARBON 47 5%	1/4W

Note:
The components identified by mark △ or dotted line with mark △ are critical for safety. Replace only with part number specified.

Note:
Les composants identifiés par une marque △ sont critiques pour la sécurité. Ne les remplacer que par une pièce portant le numéro spécifié.

TUNER

Ref. No.	Part No.	Description	Remark
R101	1-216-061-00	METAL CHIP 3.3K	5% 1/10W
R102	1-216-043-00	METAL CHIP 560	5% 1/10W
R103	1-216-049-00	METAL CHIP 1K	5% 1/10W
R104	1-216-035-00	METAL CHIP 270	5% 1/10W
R105	1-216-065-00	METAL CHIP 4.7K	5% 1/10W
R106	1-216-057-00	METAL CHIP 2.2K	5% 1/10W
R107	1-216-065-00	METAL CHIP 4.7K	5% 1/10W
R108	1-216-025-00	METAL CHIP 100	5% 1/10W
R109	1-216-065-00	METAL CHIP 4.7K	5% 1/10W
R110	△ 1-249-405-11	CARBON 100	5% 1/4W

< VARIABLE RESISTOR >

RV21	1-238-015-11	RES. ADJ. CARBON 4.7K
RV22	1-238-017-11	RES. ADJ. CARBON 22K
RV24	1-238-017-11	RES. ADJ. CARBON 22K

< TRANSFORMER >

T21	1-404-807-11	TRANSFORMER, DISCRIMINATOR
-----	--------------	----------------------------

< TERMINAL >

TM1	* 1-537-264-11	TERMINAL BOARD (SPEAKER)
-----	----------------	--------------------------

< TEST PIN >

TP1	* 1-560-060-00	PIN, CONNECTOR 2P
-----	----------------	-------------------

< VIBRATOR >

XT81	1-577-126-11	VIBRATOR, CRYSTAL
------	--------------	-------------------

MISCELLANEOUS

19	1-569-007-11	ADAPTER, CONVERSION 2P (JX411:E)
CN604	1-565-949-11	SOCKET, CONNECTOR 9P (JX311:US, Canadian, E. AUS)
CP1	△ 1-551-188-XX	CORD, POWER (JX411:E)
CP1	△ 1-558-945-11	CORD, POWER (JX411:US, Canadian)
CP1	△ 1-559-912-11	CORD, POWER (JX411:AUS)
S1	△ 1-572-267-21	SWITCH, PUSH (AC POWER) (1 KEY) (JX411)
VS1	△ 1-570-046-21	SWITCH, VOLTAGE CHANGE (JX411:E)

Ref. No.	Part No.	Description	Remark
		ACCESSORY & PACKING MATERIAL	

		1-501-374-11	ANTENNA, LOOP (JX411:US, E. AUS)
		1-558-232-11	CORD (WITH CONNECTOR) (SIRCS) 4P (JX411:US, E. AUS)
		1-559-533-11	CORD, CONNECTION (JX411:US, E. AUS)
		3-753-100-11	MANUAL, INSTRUCTION (JX411:E)
		3-753-100-21	MANUAL, INSTRUCTION (JX411:US, AUS)
	*	4-941-692-01	CUSHION (JX311:US, E. AUS/JX411)
	*	4-943-621-01	INDIVIDUAL CARTON (JX411:US, AUS)
	*	4-943-621-11	INDIVIDUAL CARTON (JX411:E)

HARDWARE LIST

# 1	7-685-646-79	SCREW +BVTP 3X8 TYPE2 N-S
# 2	7-682-548-09	SCREW +BVTT 3X8 (S)
# 3	7-685-534-19	SCREW +8TP 2.6X8 TYPE2 N-S
# 4	7-621-849-00	SCREW, TAPPING (JX411)

Note:
The components identified by mark △ or dotted line with mark △ are critical for safety. Replace only with part number specified.

Note:
Les composants identifiés par une marque △ sont critiques pour la sécurité. Ne les remplacer que par une pièce portant le numéro spécifié.

