

ST-JX421/JX521

SERVICE MANUAL

US Model
Canadian Model
E Model

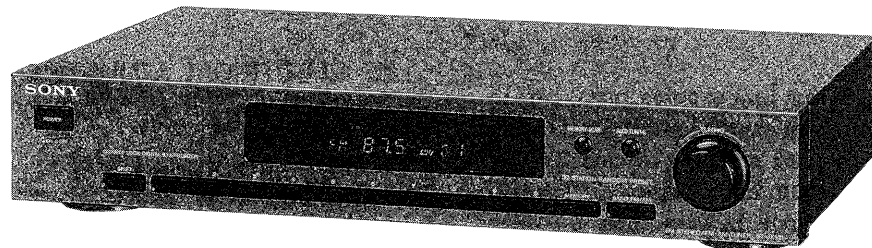

ST-JX421 is the tuner section in SEN-421CD or SEN-421.
ST-JX521 is the tuner section in SEN-521 or SEN-721.

Photo : ST-JX521

SPECIFICATIONS

FM tuner section

Tuning range	87.5 – 108 MHz
Antenna terminals	75 ohms unbalanced 300 ohms balanced
Intermediate frequency	10.7 MHz
Sensitivity (at 50 dB quieting)	22.1 dBf, 7 μ V (mono), 42.1 dBf, 70 μ V (stereo)
Usable sensitivity	19.5 dBf, 5 μ V (IHF)
Signal-to-noise ratio (at 75 kHz deviation)	80 dB (mono), 75 dB (stereo)
Harmonic distortion	0.3% (mono), 0.5% (stereo) at 1 kHz
Separation	35 dB at 1 kHz
Frequency response	30 Hz – 15 kHz ± 0.5 dB
Selectivity	55 dB at 400 kHz
AM suppression ratio	54 dB
Image response ratio	50 dB
IF response ratio	90 dB
Spurious response ratio	70 dB
Automatic tuning threshold	17.8 μ V (30 dBf)
Output	775 mV, 4.7 kohms (at 75 kHz deviation)

AM tuner section

Tuning range	US, Canadian model: 530 – 1,710 kHz (10 kHz) 531 – 1,710 kHz (9 kHz) E model: 531 – 1,602 kHz
Antenna	AM loop antenna, External antenna terminal
Intermediate frequency	450 kHz
Usable sensitivity	AM loop antenna: 500 μ V/m (999 kHz or 1,000 kHz)
Signal-to-noise ratio	54 dB

Harmonic distortion	0.5%
Selectivity	35 dB (9 kHz) 38 dB (10 kHz)

General

Power requirements	US, Canadian model: 120V AC, 60 Hz E model: 240V AC, 50 Hz
Power consumption	8W (ST-JX521)
AC outlet (U.S.A. model only)	1 unswitched, 120W/1 A max.
Dimensions	Approx. 430 x 80 x 295 mm (w/h/d) (17 x 3 $\frac{1}{4}$ x 11 $\frac{5}{8}$ inches)
Weight	ST-JX421: Approx. 2.1 kg (4 lb 11 oz) ST-JX521: Approx. 2.6 kg (5 lb 12 oz)
Accessories supplied	ST-JX421: Flat cord with 11-5-5-pin connectors (1), connected to TC-W311. Flat cord with 9-9-pin connectors (1) Remote commander RM-S102 (1) Sony batteries SUM 3 (NS) (2) ST-JX521: Remote control cord (1) Audio connecting cord (1) AM loop antenna (1) FM loop antenna (1)

Design and specifications subject to change without notice.

FM STEREO/FM-AM TUNER
SONY[®]

SAFETY CHECK-OUT

After correcting the original service problem, perform the following safety check before releasing the set to the customer:

Check the antenna terminals, metal trim, "metallized" knobs, screws, and all other exposed metal parts for AC leakage. Check leakage as described below.

LEAKAGE TEST

The AC leakage from any exposed metal part to earth ground and from all exposed metal parts to any exposed metal part having a return to chassis, must not exceed 0.5 mA (500 microamperes). Leakage current can be measured by any one of three methods.

1. A commercial leakage tester, such as the Simpson 229 or RCA WT-540A. Follow the manufacturers' instructions to use these instruments.
2. A battery-operated AC milliammeter. The Data Precision 245 digital multimeter is suitable for this job.
3. Measuring the voltage drop across a resistor by means of a VOM or battery-operated AC voltmeter. The "limit" indication is 0.75 V, so analog meters must have an accurate low-voltage scale. The Simpson 250 and Sanwa SH-63Trd are examples of a passive VOM that is suitable. Nearly all battery operated digital multimeters that have a 2V AC range are suitable. (See Fig. A)

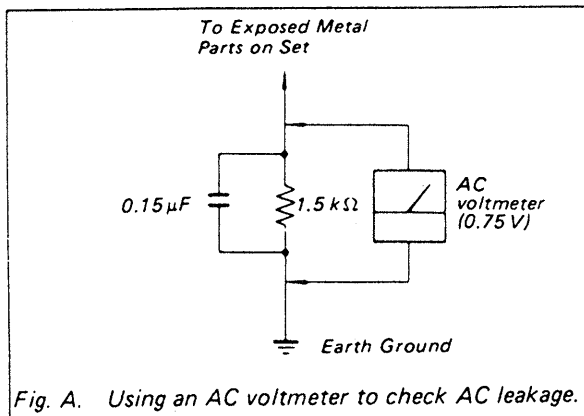

SAFETY-RELATED COMPONENT WARNING!!

COMPONENTS IDENTIFIED BY MARK \triangle OR DOTTED LINE WITH MARK \triangle ON THE SCHEMATIC DIAGRAMS AND IN THE PARTS LIST ARE CRITICAL TO SAFE OPERATION. REPLACE THESE COMPONENTS WITH SONY PARTS WHOSE PART NUMBERS APPEAR AS SHOWN IN THIS MANUAL OR IN SUPPLEMENTS PUBLISHED BY SONY.

TABLE OF CONTENTS

<i>Section</i>	<i>Title</i>	<i>Page</i>
	Specification.....	1
	Safety Check-out.....	2
1. GENERAL		
1-1.	Location of Controls.....	3
1-2.	Connections.....	4
2. ELECTRICAL ADJUSTMENTS		6
3. DIAGRAMS		
3-1.	Printed Wiring Boards.....	7
3-2.	Schematic Diagrams (Tuner Section).....	11
3-3.	Semiconductor Lead Layouts.....	13
3-4.	Waveforms.....	13
3-5.	Schematic Diagram (Control and Power Section).....	14
4. EXPLODED VIEW		17
6. ELECTRICAL PARTS LIST		19

To change the AM tuning interval

The AM tuning interval is preset at the factory to 10 kHz to match the frequency allocation system of your country. To change the interval to 9 kHz, proceed as follows.

- 1 Depress the POWER switch to turn on the unit.
- 2 Set the BAND FM/AM selector to AM.
- 3 Press the POWER switch to turn off the unit.
- 4 Hold the TUNING knob in the "+" position, and depress the POWER switch to turn on the unit. To reset the interval to 10 kHz, follow the same procedure.

Note

When the interval is changed, all preset stations which you have memorized using the numeric buttons will be erased from the memory. After changing the interval, be sure to preset the stations again.

ATTENTION AU COMPOSANT AYANT RAPPORT À LA SÉCURITÉ!

LES COMPOSANTS IDENTIFIÉS PAR UNE MARQUE \triangle SUR LES DIAGRAMMES SCHÉMATIQUES ET LA LISTE DES PIÈCES SONT CRITIQUES POUR LA SÉCURITÉ DE FONCTIONNEMENT. NE REMPLACER CES COMPOSANTS QUE PAR DES PIÈCES SONY DONT LES NUMÉROS SONT DONNÉS DANS CE MANUEL OU DANS LES SUPPLÉMENTS PUBLIÉS PAR SONY.

**SECTION 1
GENERAL**

This section is extracted from instruction manual.

1-1. LOCATION OF CONTROL

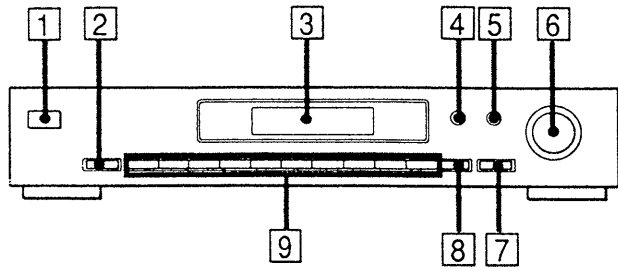

- 1 POWER switch (ST-JX521 only)
- 2 SHIFT button
- 3 Display window
- 4 MEMORY SCAN button
- 5 AUTO TUNING button
- 6 TUNING control
- 7 BAND FM/AM selector
- 8 MEMORY button
- 9 Numeric buttons

1-2. CONNECTIONS

- Connect the AC power cord last. Make sure power is off.
- Cord plugs and jacks are color coded. Red plugs and jacks are for right channel (R) and white ones for the left channel (L).
- The cable connectors should be fully inserted into the jacks. A loose connection may cause hum and noise.
- Keep speaker cords, connecting cords and power cords away from the AM loop antenna and the tuner's antenna lead-in to avoid possible noise pickup.

CAUTION
Do not put anything like another unit to obstruct the ventilation holes on the top of the amplifier.
The level surface installation is required for essential air ventilation to prevent internal heat built up in the amplifier.

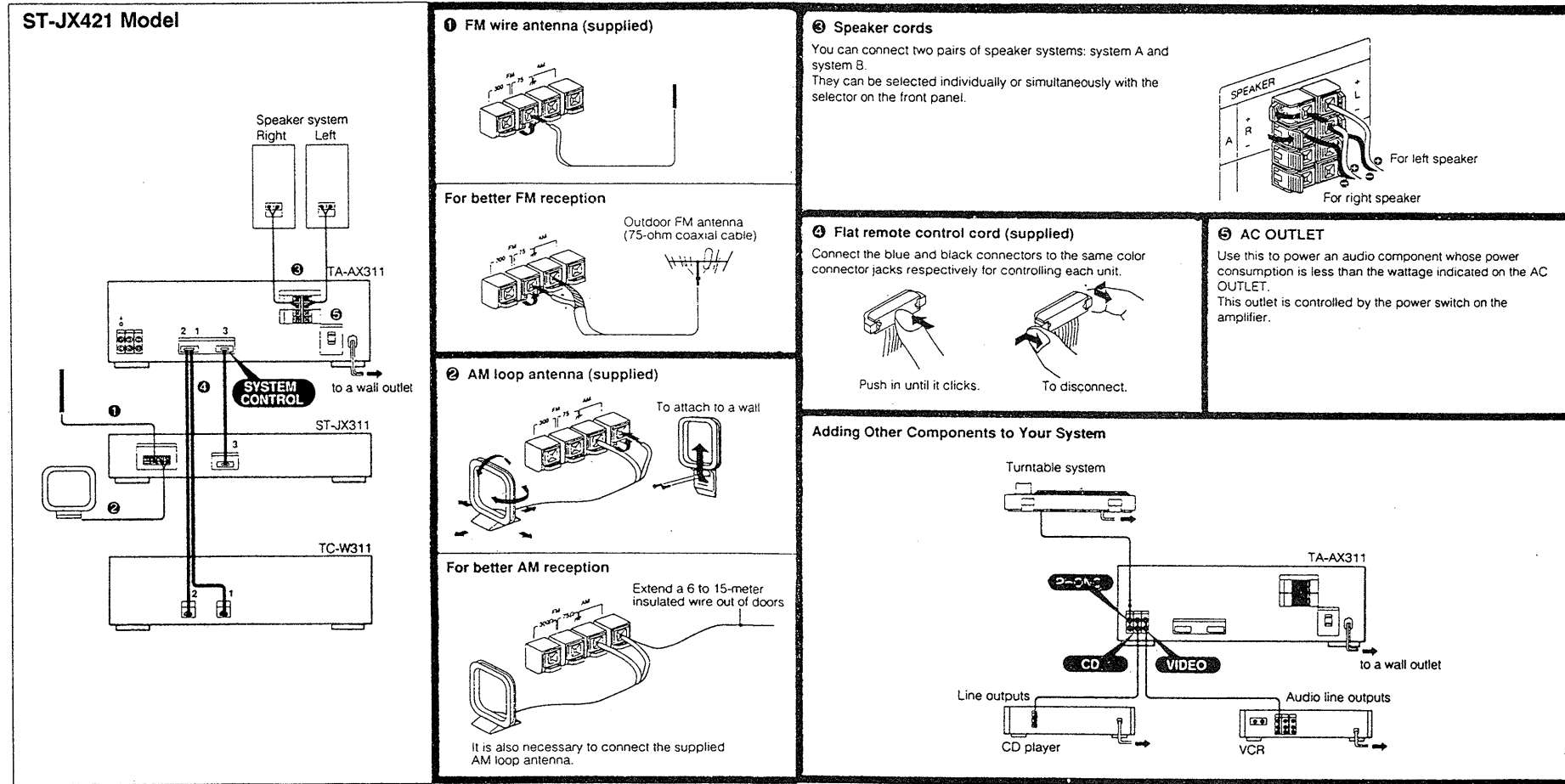

CAUTION
Do not connect any electrical home appliances such as an iron, fan, TV or other high wattage equipment to the AC OUTLET.

Note
The supplied flat cords for tape deck are already connected to the TC-W311.

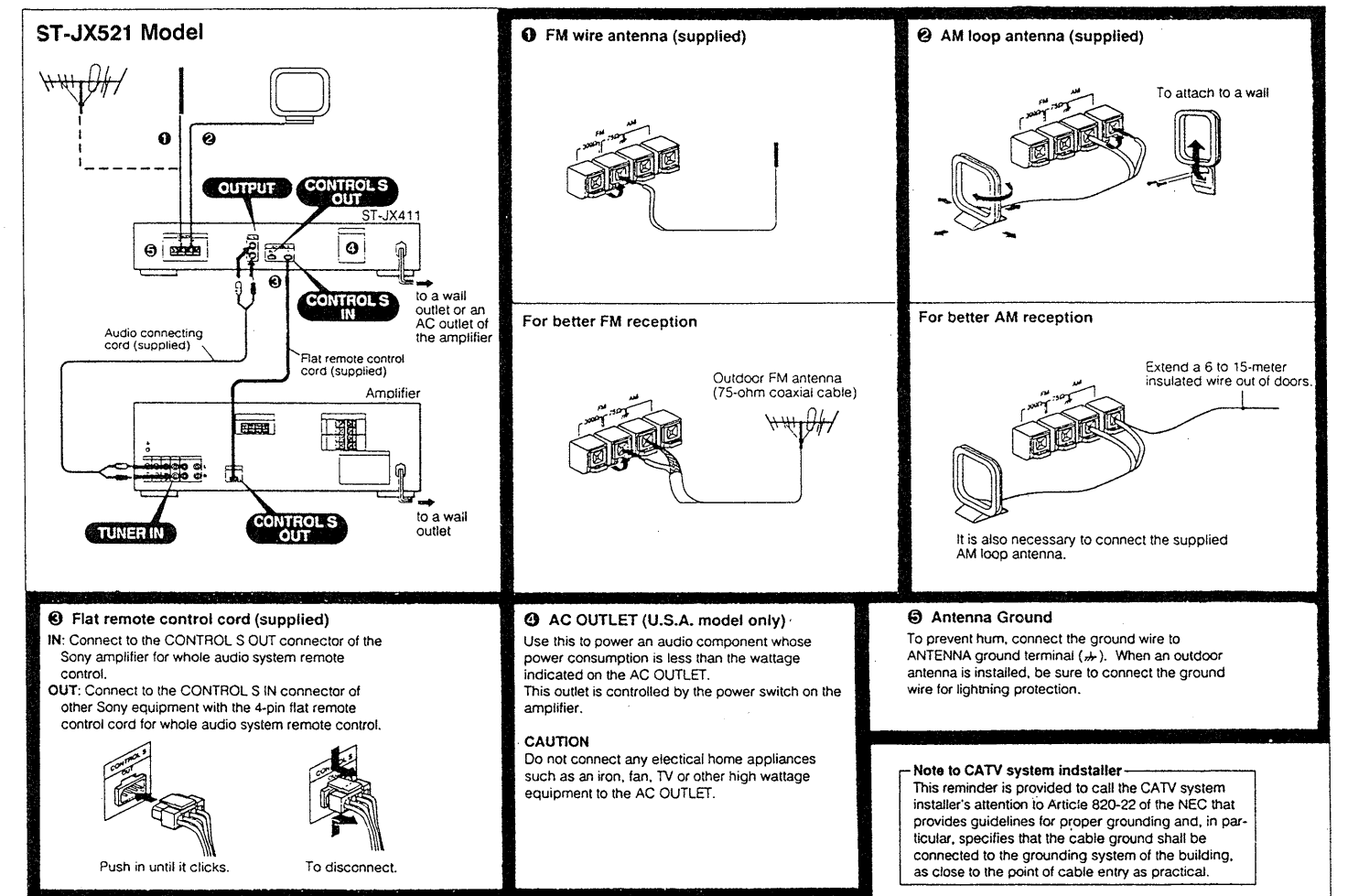

SECTION 2 ELECTRICAL ADJUSTMENTS

- TUNER BOARD - (Component side)

FM SECTION

• FM Discriminator Alignment (NULL check)

Setting :

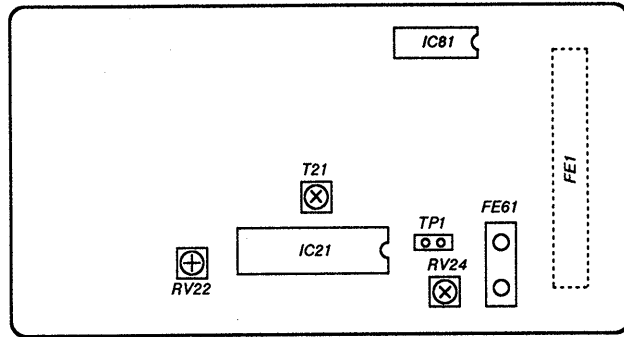
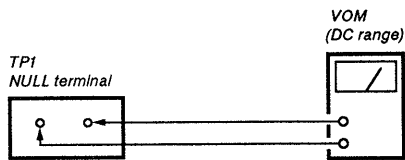
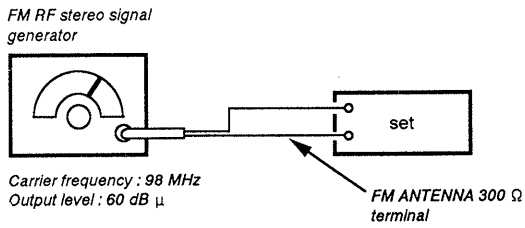

Procedure :

1. Tune the set to 98MHz.
2. Adjust T21 for 0V reading on the VOM.

Note : FM TUNING LEVEL adjustment should be made after FM discriminator alignment.

• FM TUNING LEVEL Adjustment

Setting :

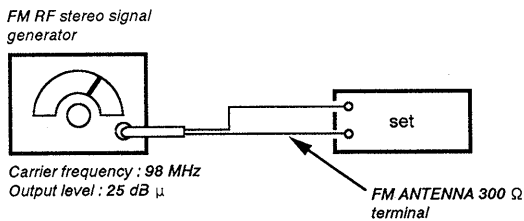

Procedure :

1. Tune the set to 98MHz.
2. Adjust RV24 so that the TUNED LED goes on.

AM SECTION

• AM Tuned Indication Lighting Level Adjustment

Setting :

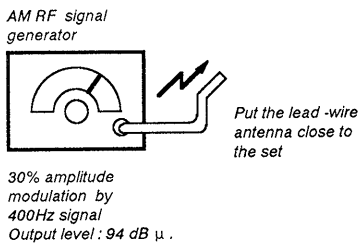

Procedure :

1. Tune the set to 1,050 kHz (US, CANADIAN), 999 kHz (E).
2. Adjust RV22 so that the TUNED LED goes on.

**SECTION 3
DIAGRAMS**

3-1. PRINTED WIRING BOARDS

Note:

- ○ — parts extracted from the component side.
- ◻ — indicates side identified with part number.
- ◻ — Pattern on the side which is seen.

(Note on Inserting the Cord to the Connector on Tuner Board)

- Insert the cord to the connector fitting Pin ① of the cord in accordance with the white mark on the board at the connector as shown in the figure.

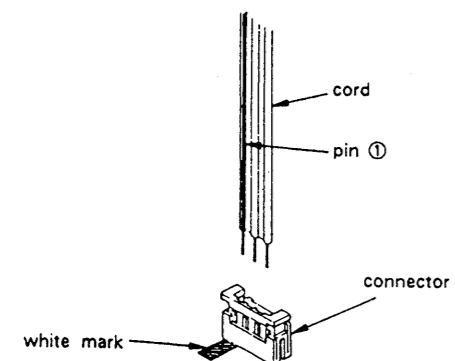

• Semiconductor Location

Ref. No.	Location	Ref. No.	Location
D21	H-5	D714	C-3
D22	H-7	D715	C-5
D23	H-6	D716	C-5
D24	H-6	D717	C-4
D501	G-17	D718	C-4
D502	G-17	IC21	J-5
D503	G-16	IC81	H-4
D504	H-16	IC501	F-18
D505	H-17	IC701	B-8
D506	H-17		
D507	F-15		
D601	I-9	Q1	I-3
D602	I-12	Q21	H-7
D701	B-12	Q22	H-7
D702	B-10	Q26	I-6
		Q27	I-7
D703	C-12		
D707	B-6	Q28	I-6
D708	C-6	Q81	H-4
D709	C-6	Q82	I-4
D710	C-3	Q83	H-5
		Q84	H-3
D711	C-3		
D712	C-3	Q601	I-10
D713	B-3	Q602	I-10

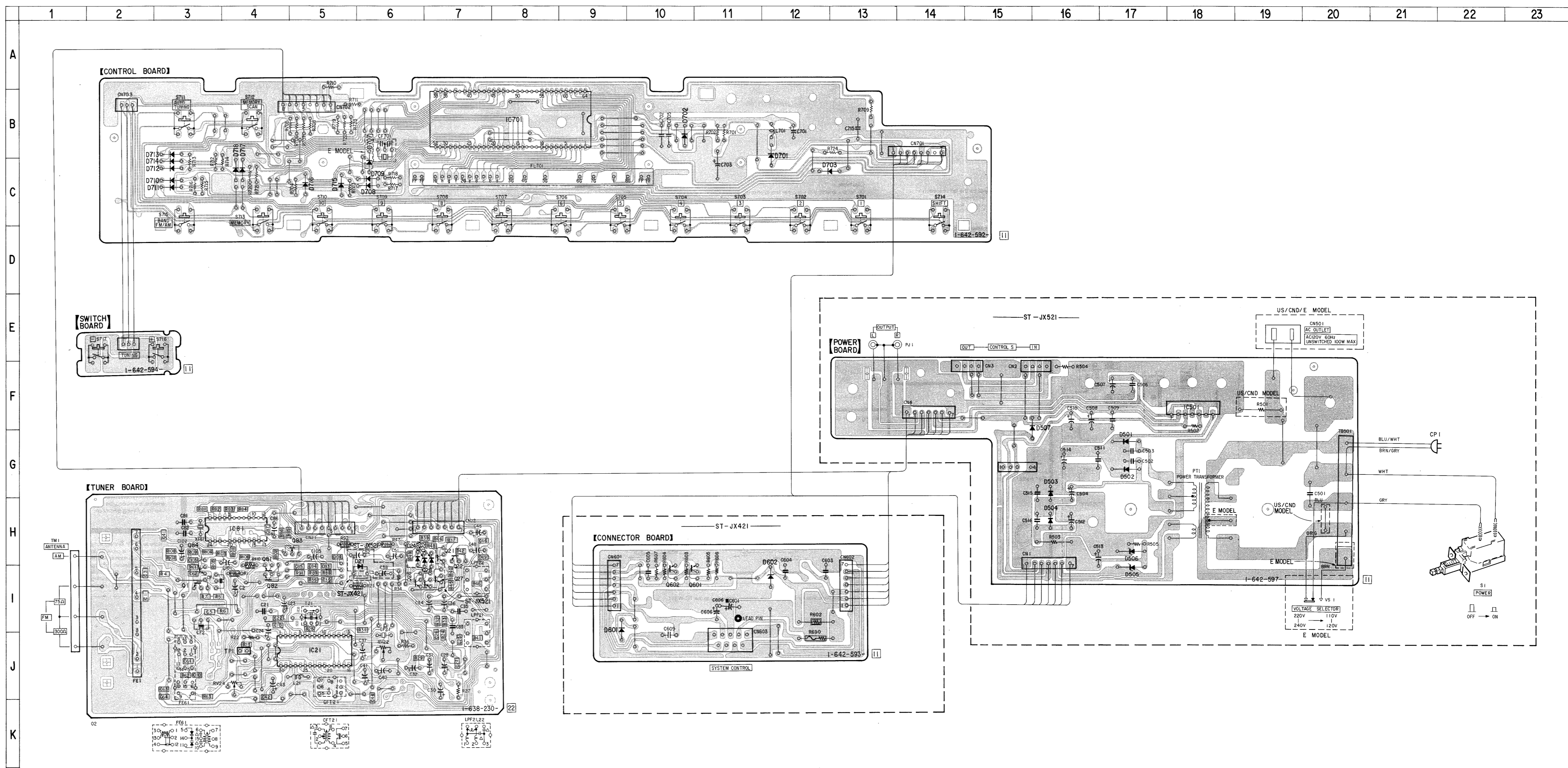

3-2. SCHEMATIC DIAGRAMS (TUNER SECTION)

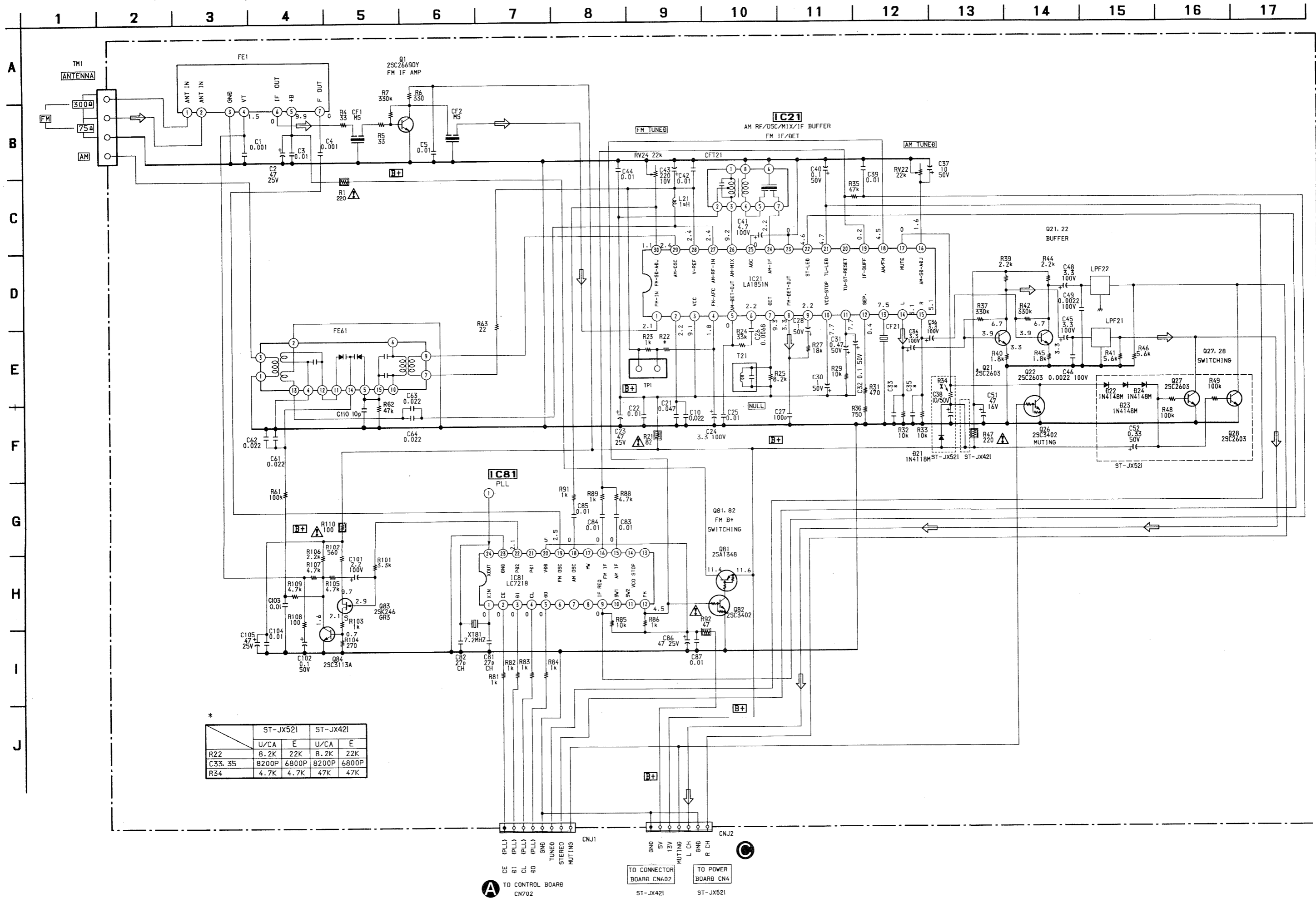

3-3. SEMICONDUCTOR LEAD LAYOUTS

EQA02-06C
IN4148M
10E2N

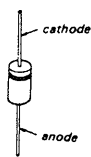

HZS6A3L
RD30ESB3

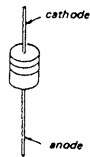

LA5667

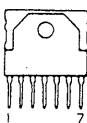

DTA114ES
DTC114ES
2SC2603-EF
2SC3113-AB
2SC2669-OY



2SK246GR3

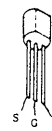

2SC2785-HFE

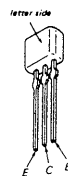

Note :

- All capacitors are in μF unless otherwise noted. pF : $\mu \mu F$
50WV or less are not indicated except for electrolytics and tantalums.
- All resistors are in Ω and $\frac{1}{4}W$ or less unless otherwise specified.
- Δ : internal component.
- : nonflammable resistor.
- : fusible resistor.

Note:
The components identified by mark Δ or dotted line with mark Δ are critical for safety. Replace only with part number specified.

Note:
Les composants identifiés par une marque Δ sont critiques pour la sécurité. Ne les remplacer que par une pièce portant le numéro spécifié.

- Voltage and waveforms are dc with respect to ground under no-signal (detuned) conditions.
- no mark : FM
- Voltages are taken with a VOM (Input impedance $10M\Omega$). Voltage variations may be noted due to normal production tolerances.
- Waveforms are taken with a oscilloscope. Voltage variations may be noted due to normal production tolerances.
- Circled numbers refer to waveforms.
- Signal path.
 \Rightarrow : FM

- **B+** : B+ Line
- **B-** : B- Line
- : adjustment for repair.

3-4. WAVEFORMS

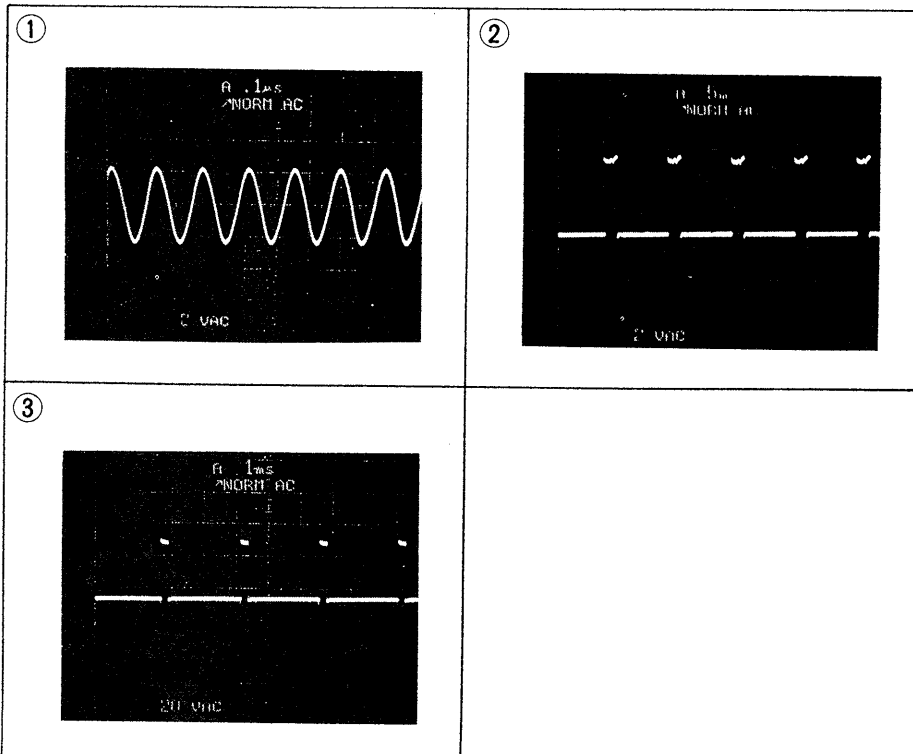

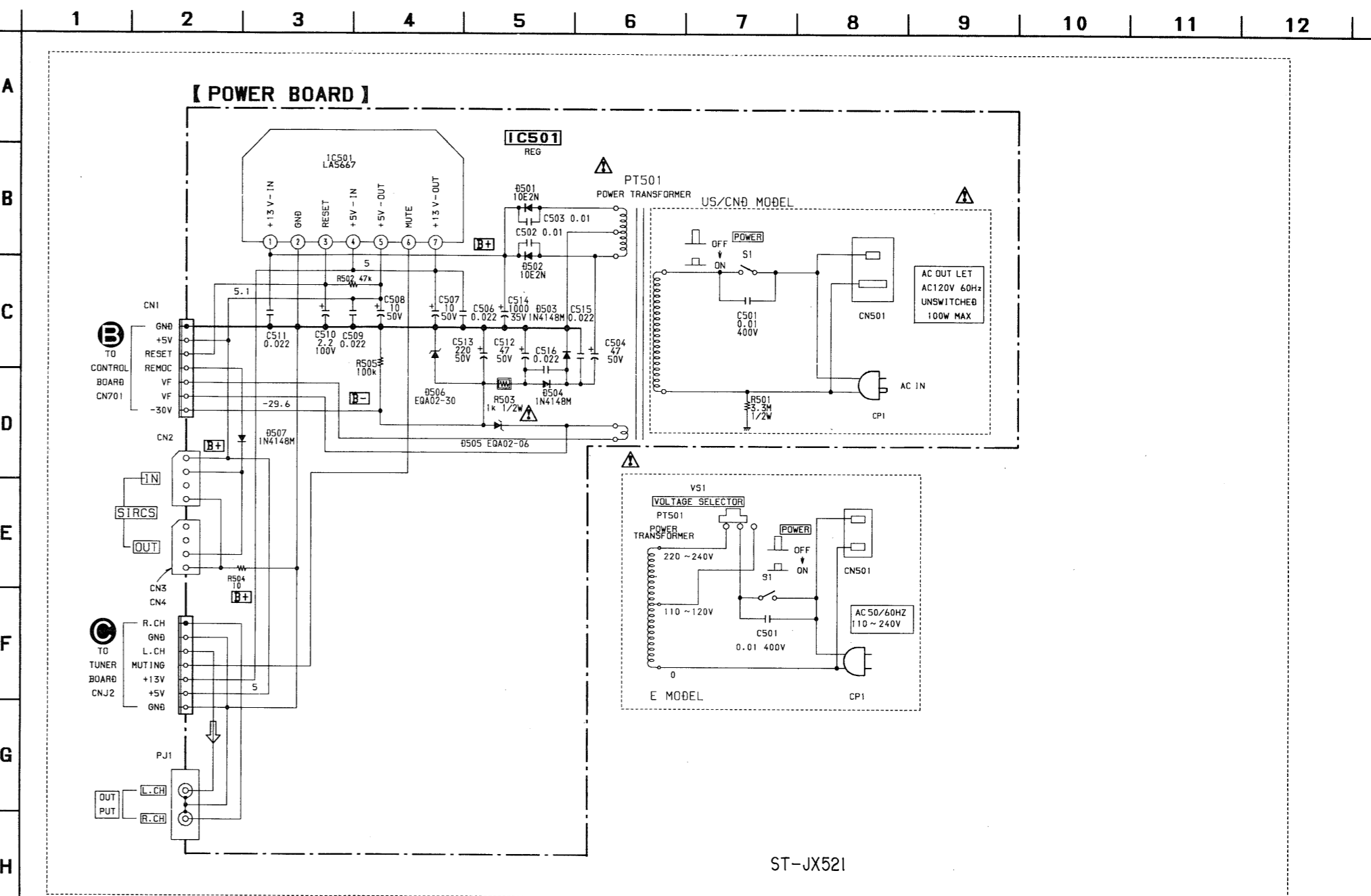
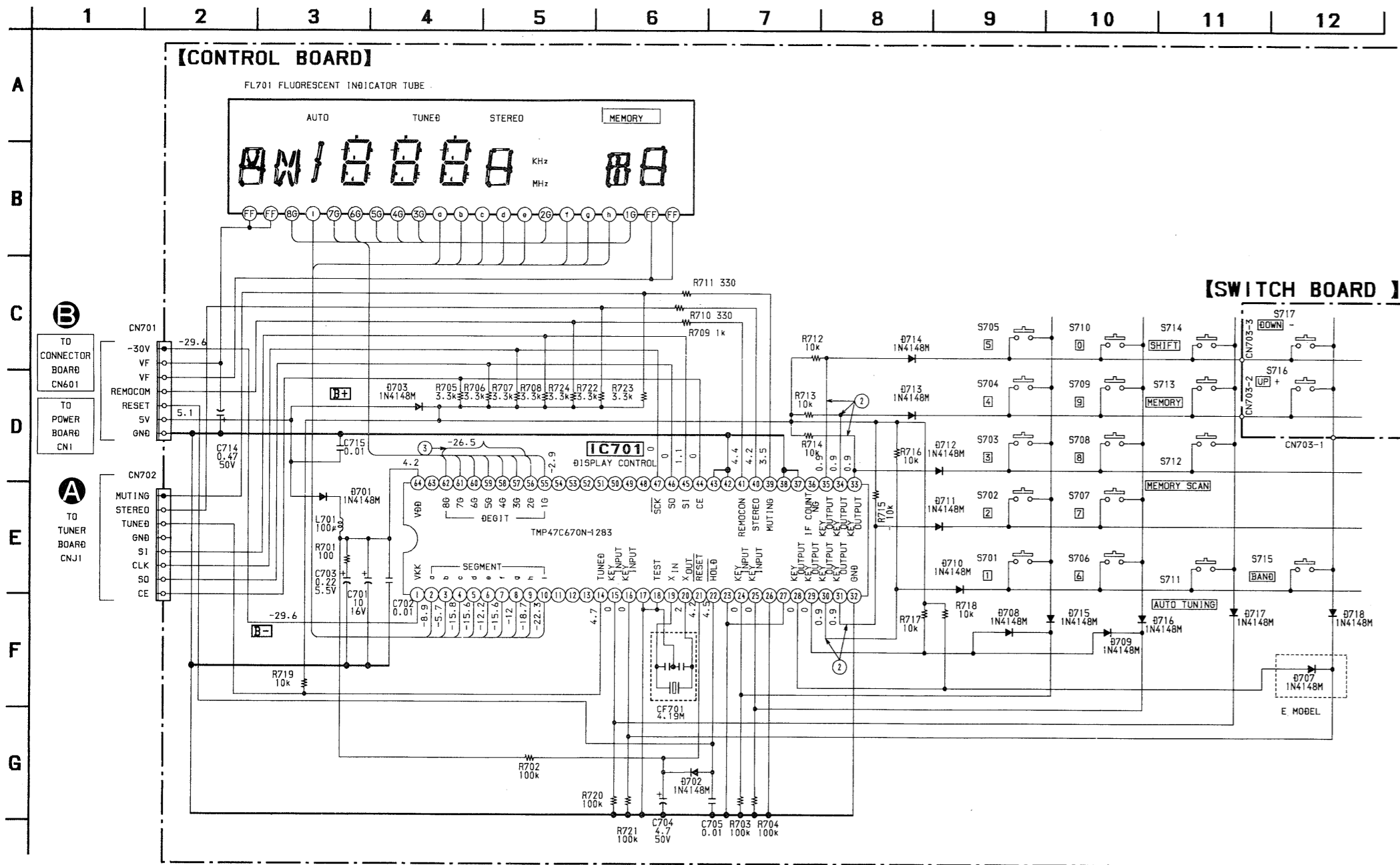

ST-JX521

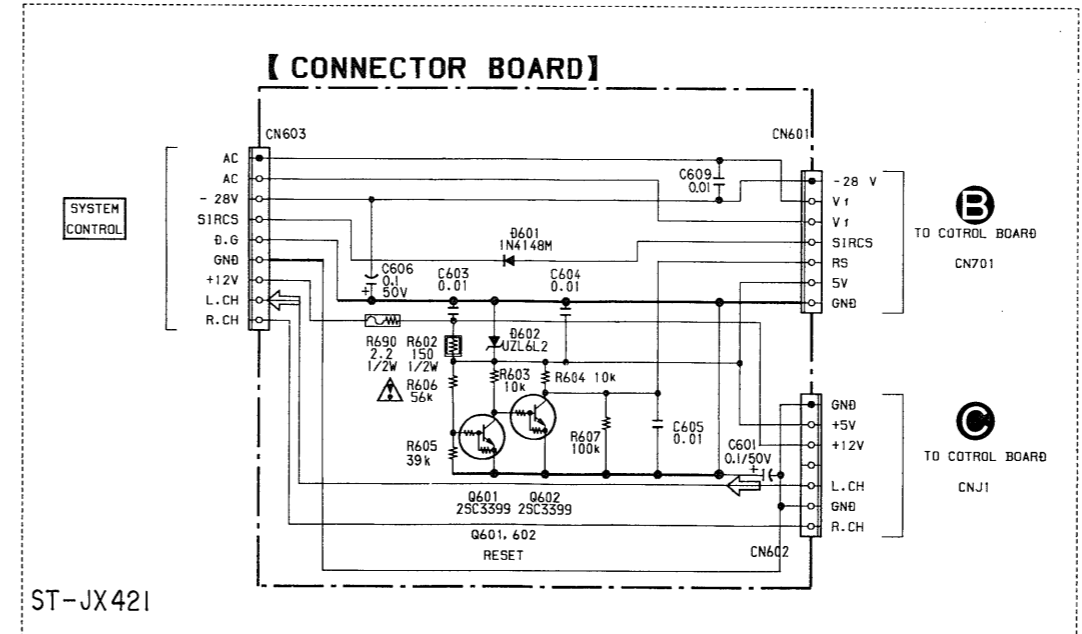

ST-JX421

SECTION 4 EXPLODED VIEW

NOTE:

- -XX, -X mean standardized parts, so they may have some differences from the original one.
- The construction parts of an assembled part are indicated with a collation number in the remark column.
- Color indication of Appearance Parts
Example:
KNOB, BALANCE (WHITE).... (RED)

↑ Parts color ↑ Cabinet's color

- Items marked "*" are not stocked since they are seldom required for routine service. Some delay should be anticipated when ordering these items.
- The mechanical parts with no reference number in the exploded views are not supplied.
- Hardware (# mark) list is given in the last of this parts list.

The components identified by mark or dotted line with mark are critical for safety. Replace only with part number specified.

Les composants identifiés par une marque sont critiques pour la sécurité. Ne les remplacer que par une pièce portant le numéro spécifié.

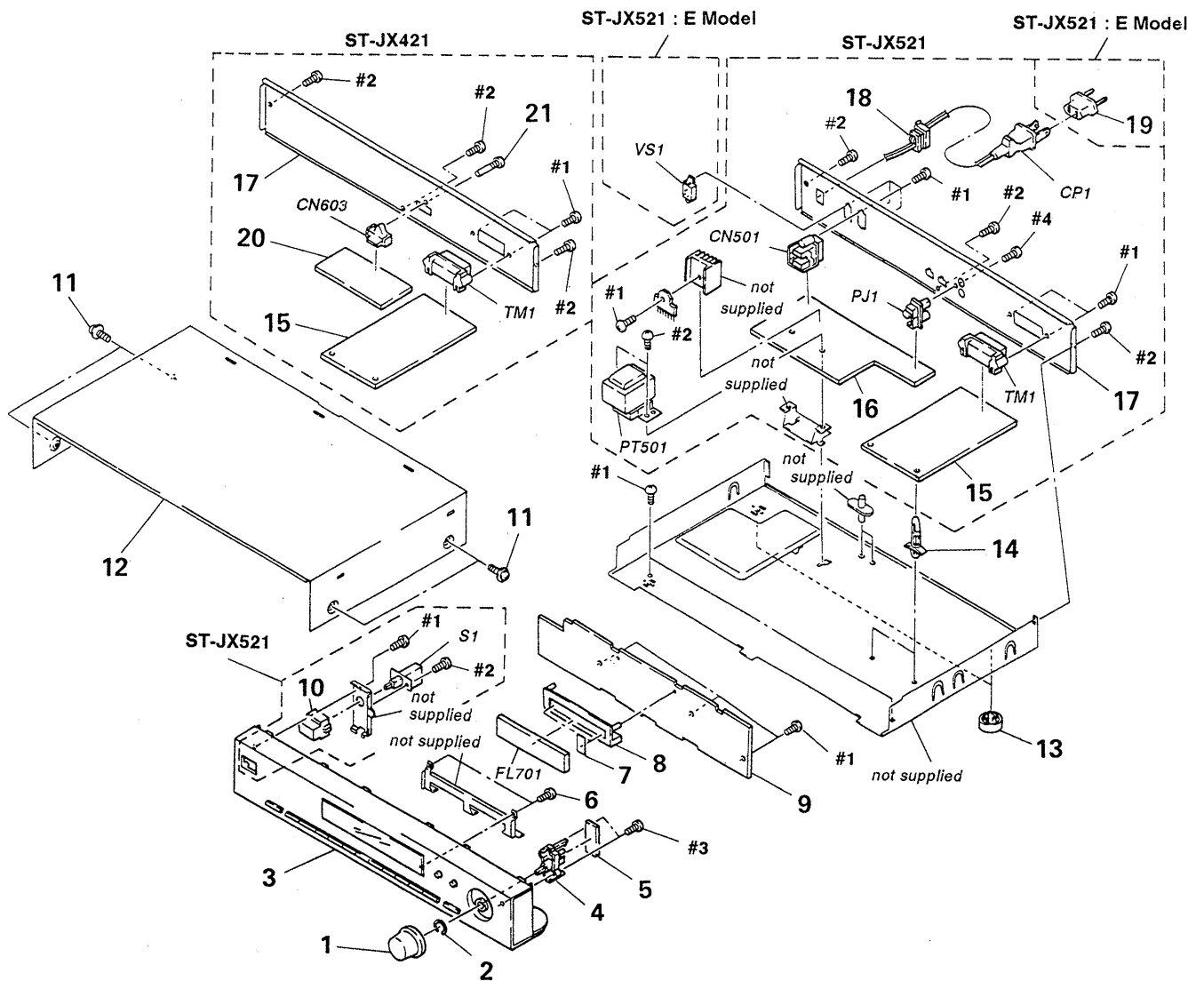

Ref.No.	Part No.	Description	Remark
1	4-943-466-01	KNOB (TUNING)	
2	4-946-017-01	SPRING, RING	
3	A-4325-402-A	PANEL ASSY, FRONT (JX521:US, Canadian)	
3	A-4325-404-A	PANEL ASSY, FRONT (JX521:E)	
3	A-4325-419-A	PANEL ASSY, FRONT (JX421:US)	
3	A-4325-420-A	PANEL ASSY, FRONT (JX421:Canadian)	
3	A-4325-421-A	PANEL ASSY, FRONT (JX421:E)	
4	X-4905-269-1	SHAFT ASSY, TUNING	
* 5	1-642-594-11	SWITCH BOARD (JX421)	
* 5	1-642-596-11	SWITCH BOARD (JX521)	
6	4-928-635-01	SCREW, +BV (2.6X8) TAPPING	
* 7	4-921-941-01	CUSHION (FL)	
* 8	4-942-301-00	HOLDER, FL TUBE	
* 9	A-4347-073-A	CONTROL BOARD, COMPLETE (JX421:US, Canadian)	
* 9	A-4347-075-A	CONTROL BOARD, COMPLETE (JX421:E)	
* 9	A-4347-139-A	CONTROL BOARD, COMPLETE (JX521:US, Canadian)	
* 9	A-4347-143-A	CONTROL BOARD, COMPLETE (JX521:E)	
10	4-917-460-01	KNOB, POWER (JX521)	
11	3-363-099-01	SCREW (CASE +3X8 TP2)	
12	4-923-457-01	CASE	
13	X-4941-228-1	FOOT ASSY	
* 14	3-346-265-11	HOLDER, PC BOARD	
* 15	A-4347-136-A	TUNER BOARD, COMPLETE (JX421:US, Canadian)	
* 15	A-4347-137-A	TUNER BOARD, COMPLETE (JX421:E)	
* 15	A-4347-141-A	TUNER BOARD, COMPLETE (JX521:US, Canadian)	
* 15	A-4347-144-A	TUNER BOARD, COMPLETE (JX521:E)	

Ref.No.	Part No.	Description	Remark
* 16	A-4347-138-A	POWER BOARD, COMPLETE (JX521:US, Canadian)	
* 16	A-4347-142-A	POWER BOARD, COMPLETE (JX521:E)	
* 17	4-943-471-31	PANEL, BACK (JX521:US, Canadian)	
* 17	4-943-471-41	PANEL, BACK (JX521:E)	
* 17	4-943-472-21	PANEL, BACK (JX421:US, Canadian)	
* 17	4-943-472-31	PANEL, BACK (JX421:E)	
* 18	3-703-571-11	BUSHING (S) (4516), CORD (JX521)	
19	1-569-007-11	ADAPTER, CONVERSION 2P (JX521:E)	
* 20	1-642-593-11	CONNECTOR BOARD (JX421)	
21	3-704-242-01	SCREW, TERMINAL, + BVTP CLAW (JX421)	
△CN501	1-540-038-11	OUTLET, AC (NONPOLAR) (1P) (JX521:E)	
△CN501	1-540-057-11	OUTLET, AC (POLAR) (AC OUTLET) (JX521:US, Canadian)	
CN603	1-565-949-11	SOCKET, CONNECTOR 9P (JX421)	
△CP1	1-551-188-XX	CORD, POWER (JX521:E)	
△CP1	1-558-945-11	CORD, POWER (JX521:US, Canadian)	
FL701	1-519-512-11	INDUCTOR TUBE, FLUORESENT	
*△PJ1	1-580-691-11	JACK, PIN 2P (OUT PUT) (JX521:US, Canadian)	
△PT501	1-450-386-11	TRANSFORMER, POWER (JX521:E)	
△PT501	1-450-387-11	TRANSFORMER, POWER (JX521:US, Canadian)	
△S1	1-572-267-21	SWITCH, PUSH (AC POWER) (1 KEY) (JX521)	
TM1	1-537-264-31	TERMINAL BOARD (ANTENNA FM/AM)	
△VS1	1-570-046-21	SWITCH, VOLTAGE CHANGE (VOLTAGE SELECTOR) (JX521:E)	

SECTION 5 ELECTRICAL PARTS LIST

CONNECTOR

CONTROL

NOTE:

- Due to standardization, replacements in the parts list may be different from the parts specified in the diagrams or the components used on the set.
- -XX, -X mean standardized parts, so they may have some difference from the original one.
- RESISTORS
All resistors are in ohms
METAL: Metal-film resistor
METAL OXIDE: Metal oxide-film resistor
F: nonflammable

- Items marked "*" are not stocked since they are seldom required for routine service. Some delay should be anticipated when ordering these items.
- SEMICONDUCTORS
In each case, u: μ , for example:
uA.....: μ A....., uPA.....: μ PA.....
uPB.....: μ PB....., uPC.....: μ PC.....
uPD.....: μ PD.....
- CAPACITORS
uF: μ F
- COILS
uH: μ H

The components identified by mark Δ or dotted line with mark Δ are critical for safety. Replace only with part number specified.

Les composants identifiés par une marque Δ sont critiques pour la sécurité. Ne les remplacer que par une pièce portant le numéro spécifié.

When indicating parts by reference number, please include the board.

Ref. No.	Part No.	Description	Remark
*	1-642-593-11	CONNECTOR BOARD (JX421) *****	
< CAPACITOR >			
C603	1-101-004-00	CERAMIC 0.01uF	50V
C604	1-101-004-00	CERAMIC 0.01uF	50V
C605	1-101-004-00	CERAMIC 0.01uF	50V
C606	1-101-004-00	CERAMIC 0.01uF	50V
C609	1-101-004-00	CERAMIC 0.01uF	50V
< CONNECTOR >			
CN601	1-506-709-11	PLUG, CONNECTOR (2.5MM) 7P	
CN603	1-565-949-11	SOCKET, CONNECTOR 9P	
< DIODE >			
D601	8-719-987-63	DIODE 1N4148M	
D602	8-719-933-35	DIODE HZS6A3L	
< TRANSISTOR >			
Q601	8-729-900-89	TRANSISTOR DTC144ES	
Δ Q602	8-729-900-89	TRANSISTOR DTC144ES	
< RESISTOR >			
Δ R602	1-247-741-11	CARBON 150 5% 1/2W F	
R603	1-249-429-11	CARBON 10K 5% 1/4W	
R604	1-249-429-11	CARBON 10K 5% 1/4W	
R605	1-249-436-11	CARBON 39K 5% 1/4W	
R606	1-249-438-11	CARBON 56K 5% 1/4W	
R607	1-249-441-11	CARBON 100K 5% 1/4W	
Δ R690	1-212-942-00	FUSIBLE 2.2 5% 1/2W F	

Ref. No.	Part No.	Description	Remark
*	A-4347-073-A	CONTROL BOARD, COMPLETE (JX421:US, Canadian)	
*	A-4347-075-A	CONTROL BOARD, COMPLETE (JX421:E)	
*	A-4347-139-A	CONTROL BOARD, COMPLETE (JX521:US, Canadian)	
*	A-4347-143-A	CONTROL BOARD, COMPLETE (JX521:E) *****	
*	4-921-941-01	CUSHION (FL)	
*	4-942-301-01	HOLDER, FL TUBE	
< CAPACITOR >			
C701	1-126-157-11	ELECT 10uF	20% 16V
C702	1-161-379-00	CERAMIC 0.01uF	20% 25V
C703	1-125-486-11	DOUBLE LAYERS 0.22F	5.5V
C704	1-126-163-11	ELECT 4.7uF	20% 50V
C705	1-161-379-00	CERAMIC 0.01uF	20% 25V
C714	1-124-465-00	ELECT 0.47uF	20% 50V
C715	1-161-379-00	CERAMIC 0.01uF	20% 25V
< FILTER >			
CF701	1-577-101-11	VIBRATOR, CERAMIC (4.19M)	
< CONNECTOR >			
CN703	1-506-468-11	CONNECTOR 3P, MALE	
< DIODE >			
D701	8-719-987-63	DIODE 1N4148M	
D702	8-719-987-63	DIODE 1N4148M	
D703	8-719-987-63	DIODE 1N4148M	
D707	8-719-987-63	DIODE 1N4148M (JX421:E, JX521:E)	
D708	8-719-987-63	DIODE 1N4148M	
D709	8-719-987-63	DIODE 1N4148M	
D710	8-719-987-63	DIODE 1N4148M	
D711	8-719-987-63	DIODE 1N4148M	
D712	8-719-987-63	DIODE 1N4148M	

CONTROL**SWITCH****TUNER**

Ref.No.	Part No.	Description	Remark
D713	8-719-987-63	DIODE 1N4148M	
D714	8-719-987-63	DIODE 1N4148M	
D715	8-719-987-63	DIODE 1N4148M	
D716	8-719-987-63	DIODE 1N4148M	
D717	8-719-987-63	DIODE 1N4148M	
D718	8-719-987-63	DIODE 1N4148M	
< FILTER >			
FL701	1-519-512-11	INDICATOR TUBE, FLUORESCENT	
< IC >			
IC701	8-759-234-35	IC TMP47C670N-1283	
< COIL >			
L701	1-410-521-11	INDUCTOR 100uH	
< RESISTOR >			
R701	1-249-405-11	CARBON 100 5% 1/4W	
R702	1-249-441-11	CARBON 100K 5% 1/4W	
R703	1-249-441-11	CARBON 100K 5% 1/4W	
R704	1-249-441-11	CARBON 100K 5% 1/4W	
R705	1-249-423-11	CARBON 3.3K 5% 1/4W	
R706	1-249-423-11	CARBON 3.3K 5% 1/4W	
R707	1-249-423-11	CARBON 3.3K 5% 1/4W	
R708	1-249-423-11	CARBON 3.3K 5% 1/4W	
R709	1-249-417-11	CARBON 1K 5% 1/4W	
R710	1-249-411-11	CARBON 330 5% 1/4W	
R711	1-249-411-11	CARBON 330 5% 1/4W	
R712	1-249-429-11	CARBON 10K 5% 1/4W	
R713	1-249-429-11	CARBON 10K 5% 1/4W	
R714	1-249-429-11	CARBON 10K 5% 1/4W	
R715	1-249-429-11	CARBON 10K 5% 1/4W	
R716	1-249-429-11	CARBON 10K 5% 1/4W	
R717	1-249-429-11	CARBON 10K 5% 1/4W	
R718	1-249-429-11	CARBON 10K 5% 1/4W	
R719	1-249-429-11	CARBON 10K 5% 1/4W	
R720	1-249-441-11	CARBON 100K 5% 1/4W	
R721	1-249-441-11	CARBON 100K 5% 1/4W	
R722	1-249-423-11	CARBON 3.3K 5% 1/4W	
R723	1-249-423-11	CARBON 3.3K 5% 1/4W	
R724	1-249-423-11	CARBON 3.3K 5% 1/4W	
< SWITCH >			
S701	1-554-303-21	SWITCH, TACTILE (1)	
S702	1-554-303-21	SWITCH, TACTILE (2)	
S703	1-554-303-21	SWITCH, TACTILE (3)	
S704	1-554-303-21	SWITCH, TACTILE (4)	
S705	1-554-303-21	SWITCH, TACTILE (5)	

Ref.No.	Part No.	Description	Remark
S706	1-554-303-21	SWITCH, TACTILE (6)	
S707	1-554-303-21	SWITCH, TACTILE (7)	
S708	1-554-303-21	SWITCH, TACTILE (8)	
S709	1-554-303-21	SWITCH, TACTILE (9)	
S710	1-554-303-21	SWITCH, TACTILE (0)	
S711	1-554-303-21	SWITCH, TACTILE (AUTO TUNING)	
S712	1-554-303-21	SWITCH, TACTILE (MEMORY SCAN)	
S713	1-554-303-21	SWITCH, TACTILE (MEMORY)	
S714	1-554-303-21	SWITCH, TACTILE (SHIFT)	
S715	1-554-303-21	SWITCH, TACTILE (BAND)	

*	1-642-594-11	SWITCH BOARD	

< SWITCH >			
S716	1-554-303-21	SWITCH, TACTILE (TUNING +)	
S717	1-554-303-21	SWITCH, TACTILE (TUNING -)	

*	A-4347-136-A	TUNER BOARD, COMPLETE	
(JX421:US, Canadian)			
*	A-4347-137-A	TUNER BOARD, COMPLETE (JX421:E)	
*	A-4347-141-A	TUNER BOARD, COMPLETE	
(JX521:US, Canadian)			
*	A-4347-144-A	TUNER BOARD, COMPLETE (JX521:E)	

< CAPACITOR >			
C1	1-163-141-00	CERAMIC CHIP 0.001uF 5% 50V	
C2	1-124-477-11	ELECT 47uF 20% 25V	
C3	1-164-232-11	CERAMIC CHIP 0.01uF 50V	
C4	1-163-141-00	CERAMIC CHIP 0.001uF 5% 50V	
C5	1-164-232-11	CERAMIC CHIP 0.01uF 50V	
C10	1-163-037-11	CERAMIC CHIP 0.022uF 10% 25V	
C21	1-161-021-11	CERAMIC 0.047uF 10% 25V	
C22	1-164-232-11	CERAMIC CHIP 0.01uF 50V	
C23	1-124-477-11	ELECT 47uF 20% 25V	
C24	1-123-382-00	ELECT 3.3uF 20% 100V	
C25	1-164-232-11	CERAMIC CHIP 0.01uF 50V	
C26	1-163-019-00	CERAMIC CHIP 0.0068uF 10% 50V	
C27	1-163-117-00	CERAMIC CHIP 100PF 5% 50V	
C28	1-124-903-11	ELECT 1uF 20% 50V	
C30	1-124-903-11	ELECT 1uF 20% 50V	
C31	1-124-902-00	ELECT 0.47uF 20% 50V	
C32	1-124-463-00	ELECT 0.1uF 20% 50V	
C33	1-130-482-00	MYLAR 0.0082uF 5% 50V	
(JX421/JX521:US, Canadian)			

TUNER

Ref. No.	Part No.	Description	Remark		
C33	1-130-481-00	MYLAR	0.0068uF	5%	50V
			(JX421/JX521:E)		
C34	1-123-382-00	ELECT	3.3uF	20%	100V
C35	1-130-482-00	MYLAR	0.0082uF	5%	50V
			(JX421/JX521:US, Canadian)		
C35	1-130-481-00	MYLAR	0.0068uF	5%	50V
			(JX421/JX521:E)		
C36	1-123-382-00	ELECT	3.3uF	20%	100V
C37	1-124-907-11	ELECT	10uF	20%	50V
C38	1-124-907-11	ELECT	10uF	20%	50V
			(JX521)		
C39	1-164-232-11	CERAMIC CHIP	0.01uF		50V
C40	1-124-463-00	ELECT	0.1uF	20%	50V
C41	1-124-927-11	ELECT	4.7uF	20%	100V
C42	1-164-232-11	CERAMIC CHIP	0.01uF		50V
C43	1-126-176-11	ELECT	220uF	20%	10V
C44	1-164-232-11	CERAMIC CHIP	0.01uF		50V
C45	1-123-382-00	ELECT	3.3uF	20%	100V
C46	1-164-161-11	CERAMIC CHIP	0.0022uF	10%	100V
C48	1-123-382-00	ELECT	3.3uF	20%	100V
C49	1-164-161-11	CERAMIC CHIP	0.0022uF	10%	100V
C51	1-124-477-11	ELECT	47uF	20%	25V
C52	1-124-252-00	ELECT	0.33uF	20%	50V
			(JX521)		
C61	1-163-037-11	CERAMIC CHIP	0.022uF	10%	25V
C62	1-163-037-11	CERAMIC CHIP	0.022uF	10%	25V
C63	1-163-037-11	CERAMIC CHIP	0.022uF	10%	25V
C64	1-163-037-11	CERAMIC CHIP	0.022uF	10%	25V
C81	1-102-961-00	CERAMIC	27PF	5%	50V
C82	1-102-961-00	CERAMIC	27PF	5%	50V
C83	1-164-232-11	CERAMIC CHIP	0.01uF		50V
C84	1-164-232-11	CERAMIC CHIP	0.01uF		50V
C85	1-164-232-11	CERAMIC CHIP	0.01uF		50V
C86	1-124-477-11	ELECT	47uF	20%	25V
C87	1-164-232-11	CERAMIC CHIP	0.01uF		50V
C101	1-124-925-11	ELECT	2.2uF	20%	100V
C102	1-124-463-00	ELECT	0.1uF	20%	50V
C103	1-164-232-11	CERAMIC CHIP	0.01uF		50V
C104	1-164-232-11	CERAMIC CHIP	0.01uF		50V
C105	1-124-477-11	ELECT	47uF	20%	25V
C110	1-163-093-00	CERAMIC CHIP	10PF	5%	50V
		< FILTER >			
CF1	1-577-070-81	FILTER, CERAMIC			
CF2	1-577-070-81	FILTER, CERAMIC			
CF21	1-577-075-11	OSCILLATOR, CERAMIC			
CFT21	1-404-853-11	TRANSFORMER, IF(CERAMIC FILTER)			
		< CONNECTOR >			
CNJ1	1-506-710-11	PLUG, CONNECTOR (2.5MM) 8P			
CNJ2	1-506-709-11	PLUG, CONNECTOR (2.5MM) 7P			

Ref. No.	Part No.	Description	Remark		
		< DIODE >			
D21	8-719-987-63	DIODE 1N4148M (JX521)			
D22	8-719-987-63	DIODE 1N4148M (JX521)			
D23	8-719-987-63	DIODE 1N4148M (JX521)			
D24	8-719-987-63	DIODE 1N4148M (JX521)			
		< FRONT END >			
FE1	1-465-006-11	FRONT END (FM) (2 GANG)			
FE61	1-239-260-11	ENCAPSULATED COMPONENT			
		< IC >			
IC21	8-759-821-45	IC LA1851N			
IC81	8-759-820-91	IC LC7218			
		< COIL >			
L21	1-410-494-11	INDUCTOR 1MMH			
		< FILTER >			
LPF21	1-235-164-00	FILTER, LOW PASS			
LPF21	1-235-164-31	FILTER, LOW PASS			
LPF22	1-235-164-00	FILTER, LOW PASS			
LPF22	1-235-164-31	FILTER, LOW PASS			
		< TRANSISTOR >			
Q1	8-729-230-XX	TRANSISTOR 2SC2669-0Y			
Q21	8-729-119-78	TRANSISTOR 2SC2785-HFE			
Q22	8-729-119-78	TRANSISTOR 2SC2785-HFE			
Q26	8-729-900-80	TRANSISTOR DTC114ES			
Q27	8-729-620-05	TRANSISTOR 2SC2603-EF (JX521)			
Q28	8-729-620-05	TRANSISTOR 2SC2603-EF (JX521)			
Q81	8-729-900-61	TRANSISTOR DTA114ES			
Q82	8-729-900-80	TRANSISTOR DTC114ES			
Q83	8-729-202-67	TRANSISTOR 2SK246-GR3			
Q84	8-729-230-93	TRANSISTOR 2SC3113-AB			
		< RESISTOR >			
△R1	1-249-409-11	CARBON 220 5% 1/4W			
R4	1-216-013-00	METAL CHIP 33 5% 1/10W			
R5	1-216-013-00	METAL CHIP 33 5% 1/10W			
R6	1-216-037-00	METAL CHIP 330 5% 1/10W			
R7	1-216-109-00	METAL CHIP 330K 5% 1/10W			
△R21	1-249-404-00	CARBON 82 5% 1/4W F			
R22	1-247-724-11	CARBON 8.2K 5% 1/4W			
		(JX421/JX521:US, Canadian)			
R22	1-249-462-11	CARBON 22K 5% 1/4W			
		(JX421:E, JX521 E)			
R23	1-216-049-00	METAL CHIP 1K 5% 1/10W			
R24	1-216-085-00	METAL CHIP 33K 5% 1/10W			
R25	1-216-071-00	METAL CHIP 8.2K 5% 1/10W			

Note:
The components identified by mark Δ or dotted line with mark Δ are critical for safety. Replace only with part number specified.

Note:
Les composants identifiés par une marque Δ sont critiques pour la sécurité. Ne les remplacer que par une pièce portant le numéro spécifié.

TUNER

POWER

Ref. No.	Part No.	Description			Remark
R27	1-249-461-11	CARBON	18K	5%	1/4W
R29	1-216-073-00	METAL CHIP	10K	5%	1/10W
R31	1-216-041-00	METAL CHIP	470	5%	1/10W
R32	1-216-073-00	METAL CHIP	10K	5%	1/10W
R33	1-216-073-00	METAL CHIP	10K	5%	1/10W
R34	1-249-465-11	CARBON	47K	5%	1/4W (JX421)
R34	1-247-721-11	CARBON	4.7K	5%	1/4W (JX521)
R35	1-216-089-00	METAL CHIP	47K	5%	1/10W
R36	1-247-128-00	CARBON	750	5%	1/4W
R37	1-216-109-00	METAL CHIP	330K	5%	1/10W
R39	1-216-057-00	METAL CHIP	2.2K	5%	1/10W
R40	1-216-055-00	METAL CHIP	1.8K	5%	1/10W
R41	1-216-067-00	METAL CHIP	5.6K	5%	1/10W
R42	1-216-109-00	METAL CHIP	330K	5%	1/10W
R44	1-216-057-00	METAL CHIP	2.2K	5%	1/10W
R45	1-216-055-00	METAL CHIP	1.8K	5%	1/10W
R46	1-216-067-00	METAL CHIP	5.6K	5%	1/10W
△R47	1-249-409-11	CARBON	220	5%	1/4W F
R48	1-216-097-00	METAL CHIP	100K	5%	1/10W(JX521)
R49	1-216-097-00	METAL CHIP	100K	5%	1/10W(JX521)
R61	1-216-097-00	METAL CHIP	100K	5%	1/10W
R62	1-216-089-00	METAL CHIP	47K	5%	1/10W
R63	1-216-009-00	METAL CHIP	22	5%	1/10W
R81	1-216-049-00	METAL CHIP	1K	5%	1/10W
R82	1-216-049-00	METAL CHIP	1K	5%	1/10W
R83	1-216-049-00	METAL CHIP	1K	5%	1/10W
R84	1-216-049-00	METAL CHIP	1K	5%	1/10W
R85	1-216-073-00	METAL CHIP	10K	5%	1/10W
R86	1-216-049-00	METAL CHIP	1K	5%	1/10W
R88	1-216-065-00	METAL CHIP	4.7K	5%	1/10W
R89	1-216-049-00	METAL CHIP	1K	5%	1/10W
R91	1-216-049-00	METAL CHIP	1K	5%	1/10W
△R92	1-249-401-11	CARBON	47	5%	1/4W F
R101	1-216-061-00	METAL CHIP	3.3K	5%	1/10W
R102	1-216-043-00	METAL CHIP	560	5%	1/10W
R103	1-216-049-00	METAL CHIP	1K	5%	1/10W
R104	1-216-035-00	METAL CHIP	270	5%	1/10W
R105	1-216-065-00	METAL CHIP	4.7K	5%	1/10W
R106	1-216-057-00	METAL CHIP	2.2K	5%	1/10W
R107	1-216-065-00	METAL CHIP	4.7K	5%	1/10W
R108	1-216-025-00	METAL CHIP	100	5%	1/10W
R109	1-216-065-00	METAL CHIP	4.7K	5%	1/10W
△R110	1-249-405-11	CARBON	100	5%	1/4W F
< VARIABLE RESISTOR >					
RV22	1-238-017-11	RES, ADJ, CARBON 22K (AM TUNED)			
RV24	1-238-017-11	RES, ADJ, CARBON 22K (FM TUNED)			

Ref. No.	Part No.	Description			Remark
		< TRANSFORMER >			
T21	1-404-807-11	TRANSFORMER, DISCRIMINATOR			
		< TERMINAL >			
TM1	1-537-264-31	TERMINAL BOARD (ANTENNA FM/AM)			
		< CONNECTOR >			
* TP1	1-560-060-00	PIN, CONNECTOR 2P			
		< CRYSTAL >			
XT81	1-577-126-11	VIBRATOR, CRYSTAL (7.2MHz)			

*	A-4347-138-A	POWER BOARD, COMPLETE (JX521:US, Canadian)			
*	A-4347-142-A	POWER BOARD, COMPLETE (JX521:E) *****			
	7-685-646-79	SCREW +BVTP 3X8 TYPE2 N-S			
		< CAPACITOR >			
△C501	1-161-744-00	CERAMIC	0.01uF		400V
C502	1-101-004-00	CERAMIC	0.01uF		50V
C503	1-101-004-00	CERAMIC	0.01uF		50V
C504	1-124-910-11	ELECT	47uF	20%	50V
C506	1-101-005-00	CERAMIC	22000PF		50V
C507	1-124-907-11	ELECT	10uF	20%	50V
C508	1-124-907-11	ELECT	10uF	20%	50V
C509	1-101-005-00	CERAMIC	22000PF		50V
C510	1-124-925-11	ELECT	2.2uF	20%	100V
C511	1-101-005-00	CERAMIC	22000PF		50V
C512	1-124-910-11	ELECT	47uF	20%	50V
C513	1-124-911-11	ELECT	220uF	20%	50V
C514	1-126-105-11	ELECT	1000uF	20%	35V
C515	1-101-005-00	CERAMIC	22000PF		50V
C516	1-101-005-00	CERAMIC	22000PF		50V
		< CONNECTOR >			
CN1	1-506-709-11	PLUG, CONNECTOR (2.5MM) 7P			
CN2	1-564-980-11	PIN, CONNECTOR 4P			
CN3	1-564-980-11	PIN, CONNECTOR 4P			
△CN501	1-540-057-11	OUTLET, AC (POLAR) (AC OUTLET) (JX521:US, Canadian)			
△CN501	1-540-038-11	OUTLET, AC (NONPOLAR) (1P)(JX521:E)			

Note:
The components identified by mark △ or dotted line with mark △ are critical for safety. Replace only with part number specified.

Note:
Les composants identifiés par une marque △ sont critiques pour la sécurité. Ne les remplacer que par une pièce portant le numéro spécifié.

POWER

Ref.No.	Part No.	Description	Remark
		< CIRCUIT BLOCK >	
△ CP1	1-551-188-XX	CORD, POWER (JX521:E)	
△ CP1	1-558-945-11	CORD, POWER (JX521:US, Canadian)	
		< DIODE >	
D501	8-719-200-77	DIODE 10E2N	
D502	8-719-200-77	DIODE 10E2N	
D503	8-719-987-63	DIODE 1N4148M	
D504	8-719-987-63	DIODE 1N4148M	
D505	8-719-912-81	DIODE EQA02-06C	
D506	8-719-110-73	DIODE RD30ES-B3	
D507	8-719-987-63	DIODE 1N4148M	
		< IC >	
IC501	8-759-820-09	IC LA5667	
		< JACK >	
*△ PJ1	1-580-691-11	JACK, PIN 2P (OUT PUT)	
		< TRANSFORMER >	
△ PT501	1-450-387-11	TRANSFORMER, POWER (JX521:US, Canadian)	
△ PT501	1-450-386-11	TRANSFORMER, POWER (JX521:E)	
		< RESISTOR >	
△ R501	1-202-725-00	SOLID 3.3M 10% 1/2W F (JX521:US, Canadian)	
R502	1-249-437-11	CARBON 47K 5% 1/4W	
△ R503	1-247-752-11	CARBON 1K 5% 1/2W F	
R504	1-249-393-11	CARBON 10 5% 1/4W	
R505	1-249-441-11	CARBON 100K 5% 1/4W	
		< SWITCH >	
△ S1	1-572-267-21	SWITCH, PUSH (AC POWER) (1 KEY) (POWER)	
		< TERMINAL >	
* TB501	1-535-140-00	BASE POST 22MM (10MM PITCH) 3P (JX521:US, Canadian)	
		< SWITCH >	
△ VS1	1-570-046-21	SWITCH, VOLTAGE CHANGE (VOLTAGE SELECTOR) (JX521:E)	

Ref.No.	Part No.	Description	Remark
		MISCELLANEOUS *****	
19	1-569-007-11	ADAPTER, CONVERSION 2P (JX521:E)	
CN603	1-565-949-11	SOCKET, CONNECTOR 9P	
△ CP1	1-551-188-XX	CORD, POWER (JX521:E)	
△ CP1	1-558-945-11	CORD, POWER (JX521:US, Canadian)	
△ S1	1-572-267-21	SWITCH, PUSH (AC POWER) (1 KEY) (POWER) (JX521)	
△ VS1	1-570-046-21	SWITCH, VOLTAGE CHANGE (VOLTAGE SELECTOR) (JX521:E)	

ACCESSORIES & PACKING MATERIALS

1-501-374-11	ANTENNA, LOOP (JX521)
1-558-232-11	CORD (WITH CONNECTOR) (SIRCS) 4P (JX521:US, E)
1-558-232-21	CORD (WITH CONNECTOR) (SIRCS) 4P (JX521:Canadian)
1-559-533-11	CORD, CONNECTION (JX521:Canadian)
1-559-534-11	CORD, CONNECTION (JX521:US, E)
3-754-913-21	MANUAL INSTRUCTION (JX521) (English)...US, Canadian
3-754-913-31	MANUAL INSTRUCTION (JX521) (French)...Canadian
*	4-941-692-01 CUSHION
*	4-943-621-22 INDIVIDUAL CARTON (JX521:US, Canadian)

HARDWARE LIST

#1	7-685-646-79	SCREW +BVTP 3X8 TYPE2 N-S
#2	7-682-548-09	SCREW +BVTT 3X8 (S)
#3	7-685-534-19	SCREW +BTP 2.6X8 TYPE2 N-S
#4	7-621-849-00	SCREW, TAPPING (JX521)

Note:
The components identified by mark **△** or dotted line with mark **△** are critical for safety. Replace only with part number specified.

Note:
Les composants identifiés par une marque **△** sont critiques pour la sécurité. Ne les remplacer que par une pièce portant le numéro spécifié.

