

*AEP Model  
UK Model  
SCN Model*

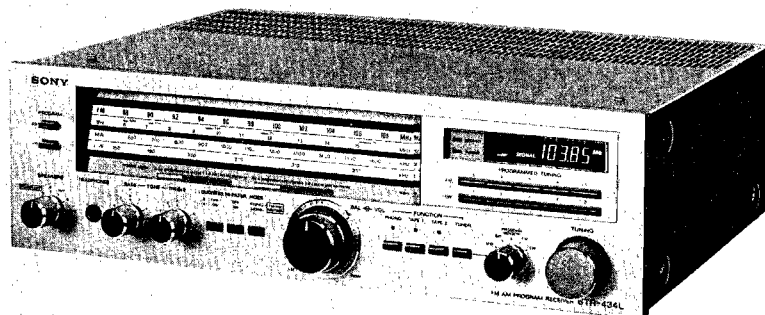

## FM-AM PROGRAM RECEIVER

### SPECIFICATIONS

#### GENERAL

- System:** Superheterodyne FM/AM tuner, Direct coupled pure-complementary symmetry power amplifier circuit (SEPP OTL)
- Power Requirements:** UK model: 240 V ac (or 220 V ac adjustable by authorized Sony personnel), 50 Hz  
AEP, SCN model: 220 V ac (or 240 V ac adjustable by authorized Sony personnel), 50 Hz
- Power Consumption:** UK model: 380 W  
AEP, SCN model: 290 W
- AC Outlets:** Two unswitched, total 200 W (not provided for SCN model)
- Dimensions:** Approx. 430 (w) x 135 (h) x 370 (d) mm  
17 (w) x 5 1/4 (h) x 14 5/8 (d) inches including projecting parts and controls
- Weight:** Approx. 9.3 kg, 20 lb 9 oz (net)  
Approx. 10.5 kg, 23 lb 3 oz (in shipping carton)

#### FM TUNER SECTION

- Tuning Range:** 87.5 – 108 MHz
- Antenna Terminals:** 300  $\Omega$  balanced  
75  $\Omega$  unbalanced
- Intermediate Frequency:** 10.7 MHz
- Sensitivity at 50dB Quieting:** 3.5  $\mu$ V, 16.1 dB (mono)  
45  $\mu$ V, 38.3 dBf (stereo)
- Sensitivity at 46dB Quieting:** 4.0  $\mu$ V (mono)  
50  $\mu$ V (stereo)  
(at 40kHz deviation)
- Usable Sensitivity:** IHF 1.8  $\mu$ V, 10.3 dBf  
1.6  $\mu$ V (S/N = 26 dB, 40 kHz deviation)
- Signal-to-noise Ratio:** 75 dB (mono)  
70 dB (stereo)
- Harmonic Distortion:** 0.15 % (mono)  
0.3 % (stereo)  
at 1 kHz
- IM Distortion:** 0.15 % (mono)  
0.3 % (stereo)

#### SAFETY-RELATED COMPONENT WARNING!!

COMPONENTS IDENTIFIED BY SHADING AND MARK  ON THE SCHEMATIC DIAGRAMS, EXPLODED VIEWS AND IN THE PARTS LIST ARE CRITICAL TO SAFE OPERATION. REPLACE THESE COMPONENTS WITH SONY PARTS WHOSE PART NUMBERS APPEAR AS SHOWN IN THIS MANUAL OR IN SUPPLEMENTS PUBLISHED BY SONY.

— Continued on page 2 —

# SONY<sup>®</sup>

## SERVICE MANUAL

# STR-434L

**Separation:** 45 dB at 1 kHz  
**Frequency Response:** 40 Hz – 12.5 kHz  $\begin{smallmatrix} +0.5 \\ -1 \end{smallmatrix}$  dB (DIN)  
 30 Hz – 15 kHz  $\begin{smallmatrix} +0.5 \\ -2 \end{smallmatrix}$  dB (IHF)  
**Selectivity at 300kHz:** 55 dB  
 (at 40kHz deviation,  
 S/N = 26dB)  
**Capture Ratio:** 1.0 dB  
**AM Suppression Ratio:** 54 dB  
**Image Response Ratio:** 75 dB  
**Spurious Response Ratio:** 75 dB  
**Muting Threshold:** Approx. 5  $\mu$ V

## SW/MW/LW TUNER SECTION

	SW	MW	LW
<b>Tuning range</b>	5.8 MHz – 15.8 MHz	522 kHz – 1,602 kHz	150 kHz – 350 kHz
<b>Antenna</b>	External antenna terminal	Built-in ferrite rod antenna, External antenna terminal	
<b>Intermediate frequency</b>	450 kHz		
<b>Usable sensitivity</b>	30 $\mu$ V, external antenna (10 MHz)	250 $\mu$ V/m, built-in antenna (1,000 kHz) 100 $\mu$ V, external antenna (1,000 kHz)	500 $\mu$ V/m, built-in antenna (230 kHz) 100 $\mu$ V, external antenna (230 kHz)
<b>Signal-to noise ratio</b>	52 dB (5 mV)	52 dB (50 mV/m)	52 dB (50 mV/m)
<b>Harmonic distortion</b>	0.3 % (5 mV, 400 Hz)	0.3 % (50 mV/m, 400 Hz)	0.3 % (50 mV/m, 400 Hz)
<b>Selectivity</b>	50 dB (9 kHz)	50 dB (9 kHz)	50 dB (9 kHz)

## AMPLIFIER SECTION

**Continuous RMS Power Output:** at 20 Hz – 20 kHz  
 (less than 0.08% THD, both channels driven simultaneously) at 1 kHz  
 40 + 40 W (8  $\Omega$ )  
 40 + 40 W (4  $\Omega$ )  
 43 + 43 W (8  $\Omega$ )  
 43 + 43 W (4  $\Omega$ )  
 according to DIN 45500  
 40 + 40 W (8  $\Omega$ )  
 40 + 40 W (4  $\Omega$ )

**Dynamic Power Output:** 130 W (8  $\Omega$ )  
 (IHF constant power supply method) 130 W (4  $\Omega$ )

**Power Bandwidth (IHF):** 10 Hz – 40 kHz

**Damping Factor:** 20 at 1 kHz, 8  $\Omega$

**Harmonic Distortion:** Less than 0.08 % at rated output  
 Less than 0.08 % at 1 W output

**Intermodulation (IM) Distortion:** Less than 0.08 % at rated output  
 (60Hz : 7kHz = 4 : 1) Less than 0.08 % at 1 W output

**Residual Noise:** Less than 0.08  $\mu$ W at 8  $\Omega$

### Inputs:

	Sensitivity	Impedance	S/N	Weighting network
PHONO	2.5 mV	50 k $\Omega$	80 dB	A
TAPE 1, 2	150 mV	100 k $\Omega$	95 dB	A

Measured with rated output power into 8  $\Omega$  loads (both channels driven simultaneously) at 1 kHz.

### Outputs (with rated input):

REC OUT 1, 2	Voltage 150 mV Impedance 10 k $\Omega$
HEADPHONES	Accepts all low or high impedance headphones.
SPEAKER	4 – 16 $\Omega$ speakers are suitable.

**Frequency Response:** PHONO  
 RIAA equalization curve  $\pm 0.5$  dB  
 TAPE 1, 2

10 Hz – 50 kHz  $\begin{smallmatrix} +1 \\ -3 \end{smallmatrix}$  dB

**Tone Controls:** BASS  $\pm 10$  dB at 100 Hz  
 TREBLE  $\pm 10$  dB at 10 kHz

**High Filter:** 6 dB/oct. above 7.5 kHz

**Loudness Control:** +6 dB at 100 Hz  
 (att. 30dB) +3 dB at 10 kHz

**MODEL IDENTIFICATION**

– Print on Rear Panel –

<b>SONY</b> <sup>®</sup>	<b>FM-AM PROGRAM RECEIVER</b>
	MODEL NO. STR-434L
	FREQ. RANGE : FM 87.5 - 108MHz SW 5.8 - 15.8MHz MW 522 - 1602KHz LW 150 - 350KHz
	IF : FM 10.7MHz AM 450KHz
	MADE IN JAPAN
SERIAL NO.	

<i>UK MODEL</i>	<i>AC 240V ~50Hz</i>	<i>380W</i>
<i>AEP MODEL</i>	<i>AC 220V ~50Hz</i>	<i>290W</i>
<i>SCN MODEL</i>		

## – AC Outlet –

SCN model has no ac outlet.





1-2. BLOCK DIAGRAM

- ① While keeping the FM PROGRAM button depressed, the voltage supplied to this line turns Q203 and Q202 on, and suspends the AFC function.
- ② When the Band Selector (S5) is set to the PROGRAM SENSOR position, a selection of LW or FM mode is done by connecting the B+ bus to the respective circuit.
- ③ When one of the preset switches (S6-1 to S6-10) is pressed, this line level becomes high so that Q209 turns off and the muting circuit is cut off. When all of the preset switches are OFF, Q209 is ON and the muting circuit is active since this line is grounded via R915 and D908.
- ④ In SW, MW and LW reception, the CX168 function is switched to AM mode.
- ⑤ The counter function is switched by this line voltage, depending on the IF frequency either FM IF freq. or AM IF freq.

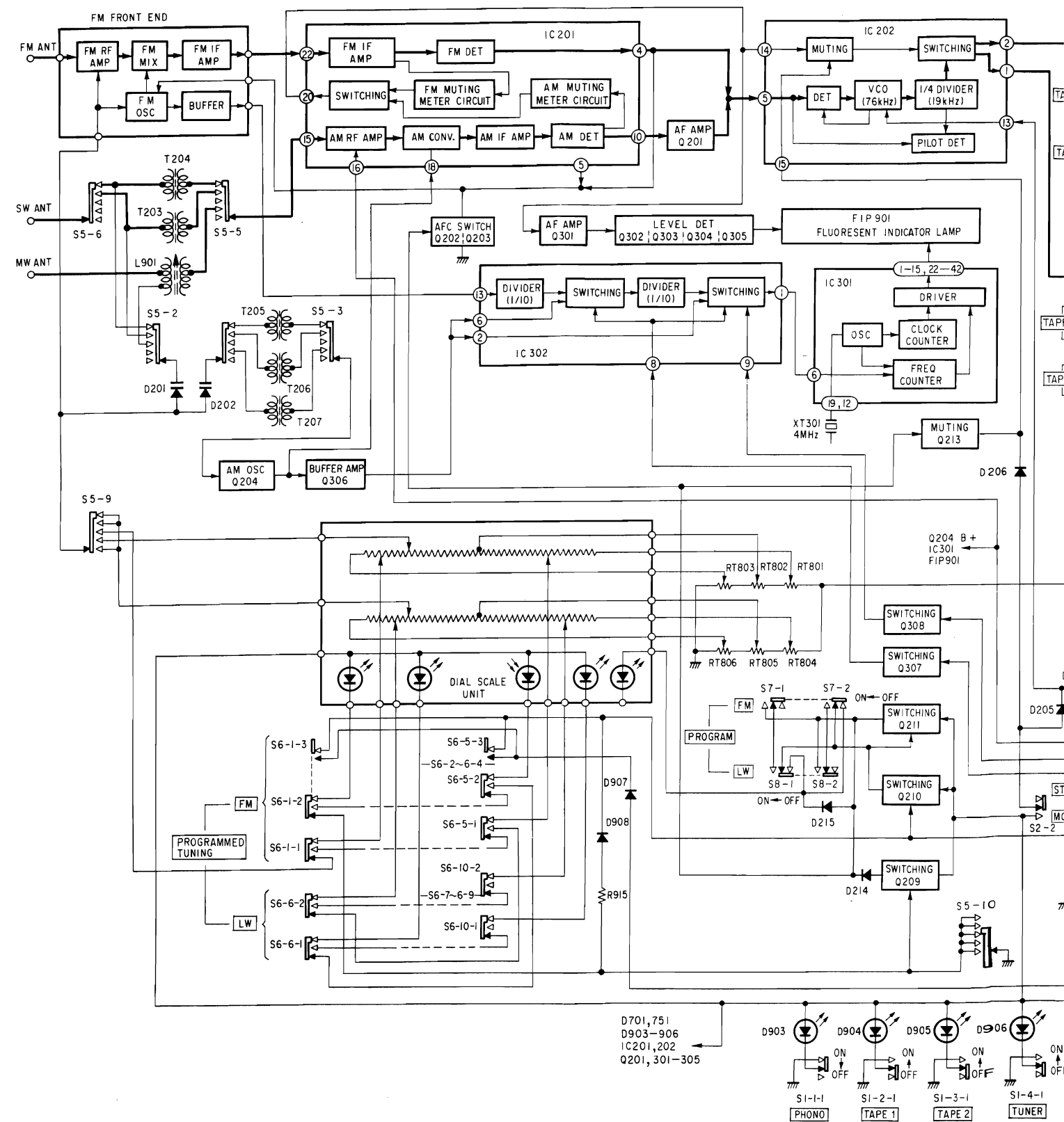

1-2. BLOCK DIAGRAM

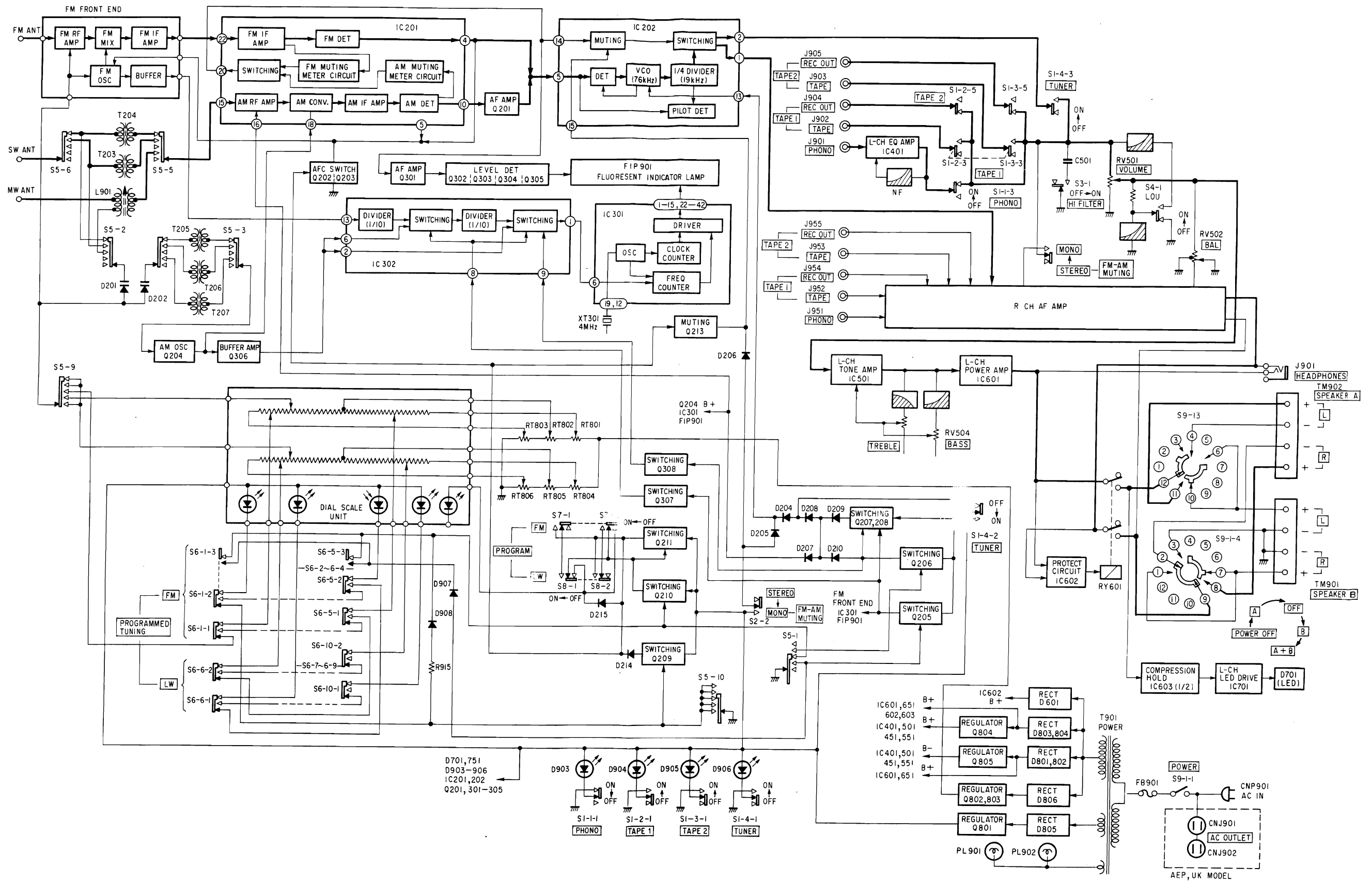

SECTION 2  
DISASSEMBLY

• Follow the disassembly procedure in the numerical order given.

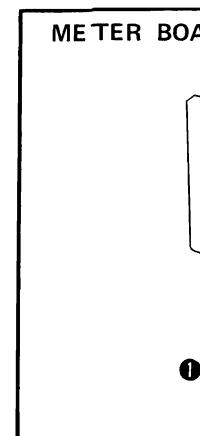
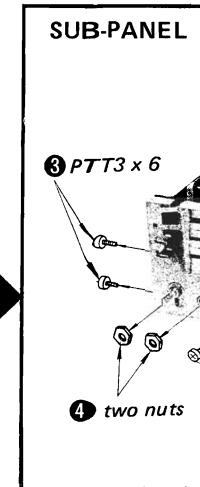
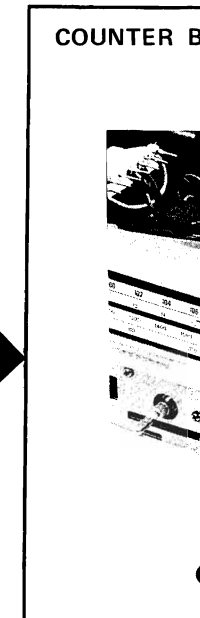
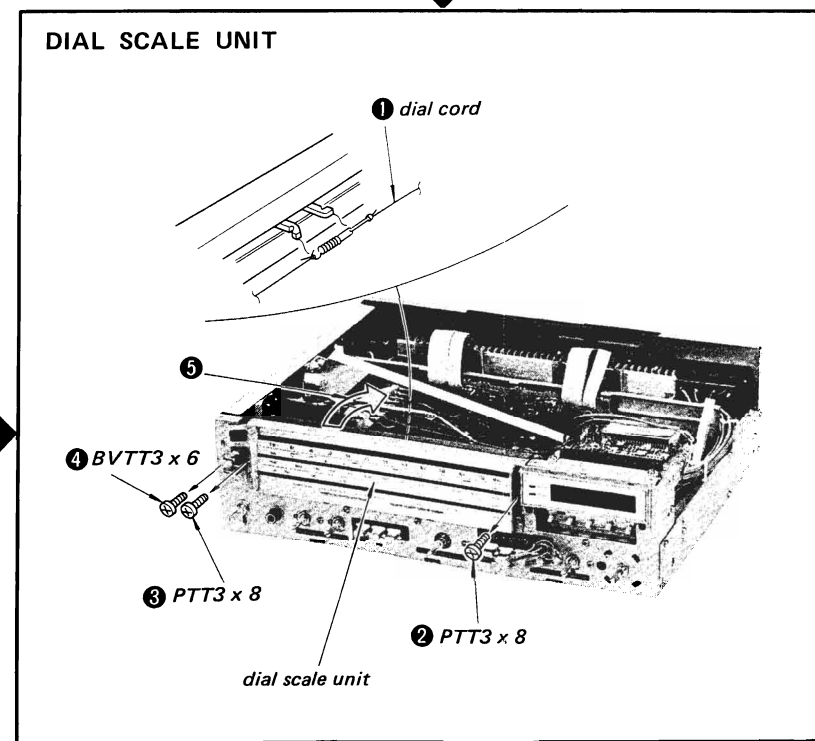
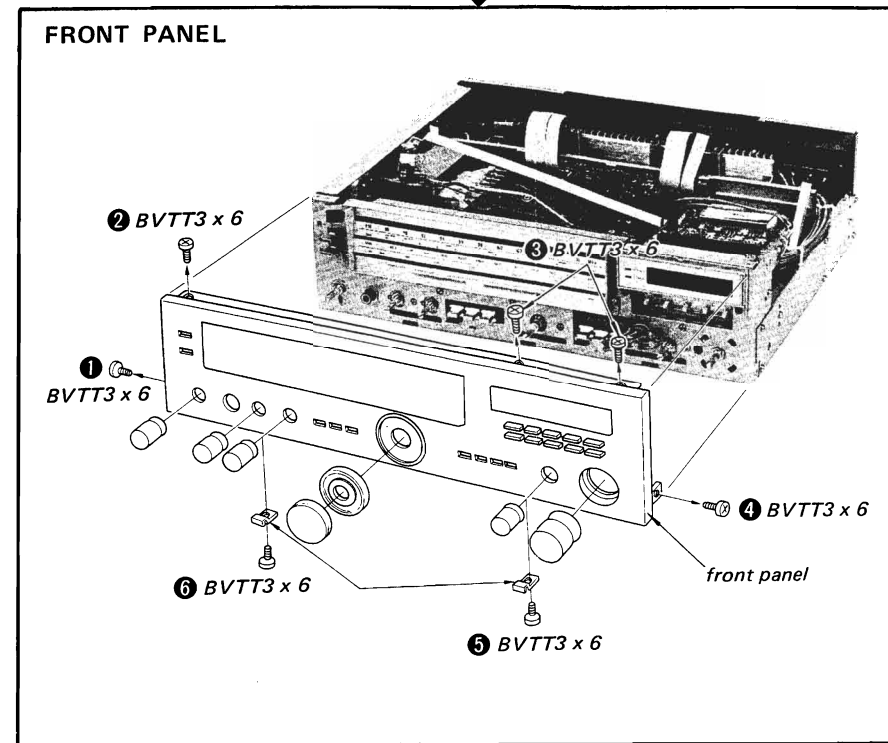
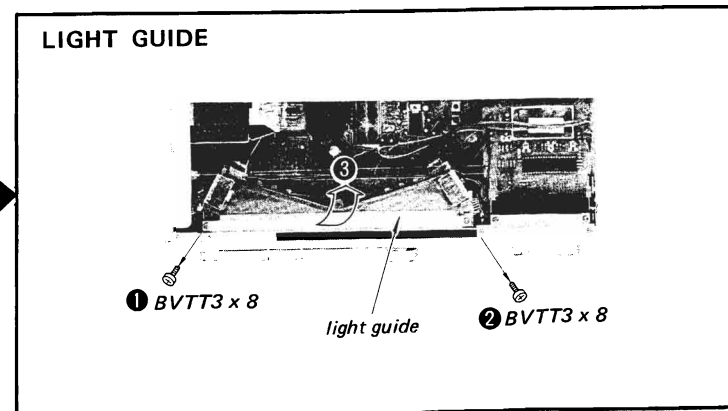
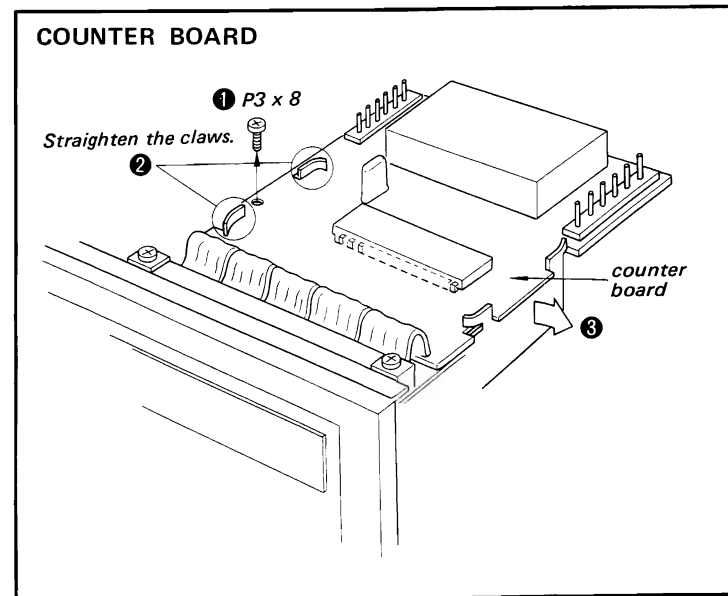
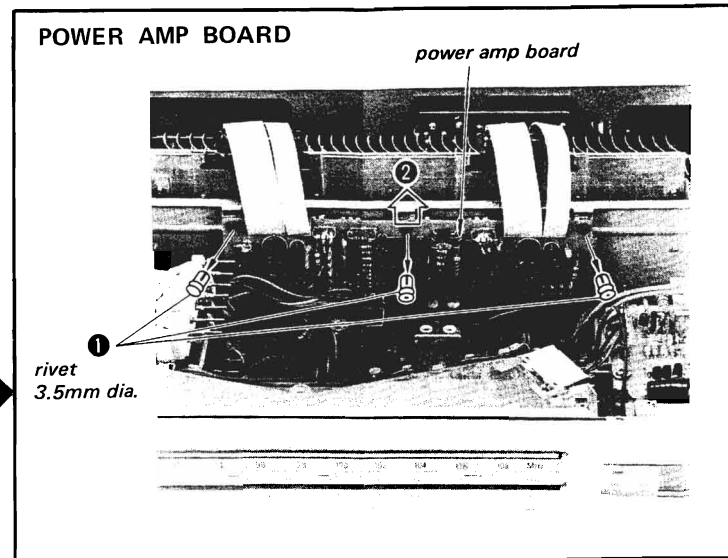
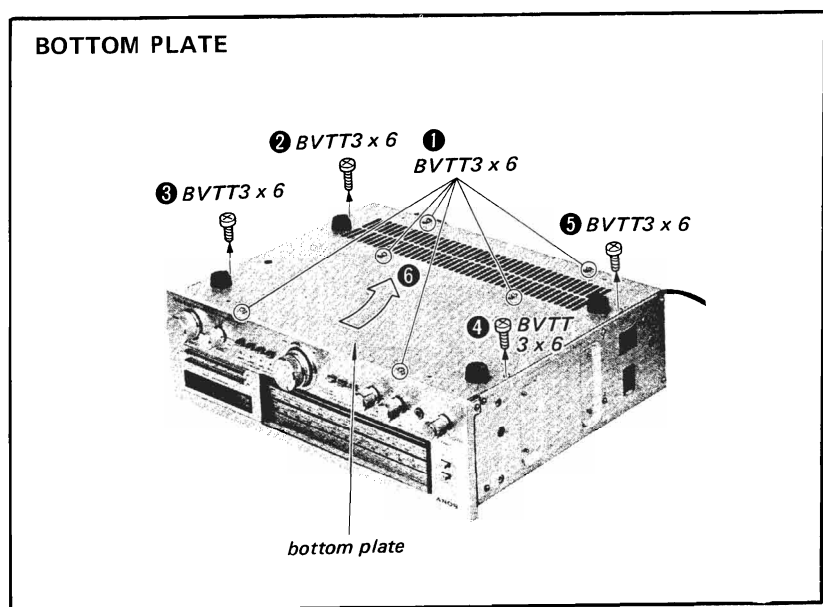
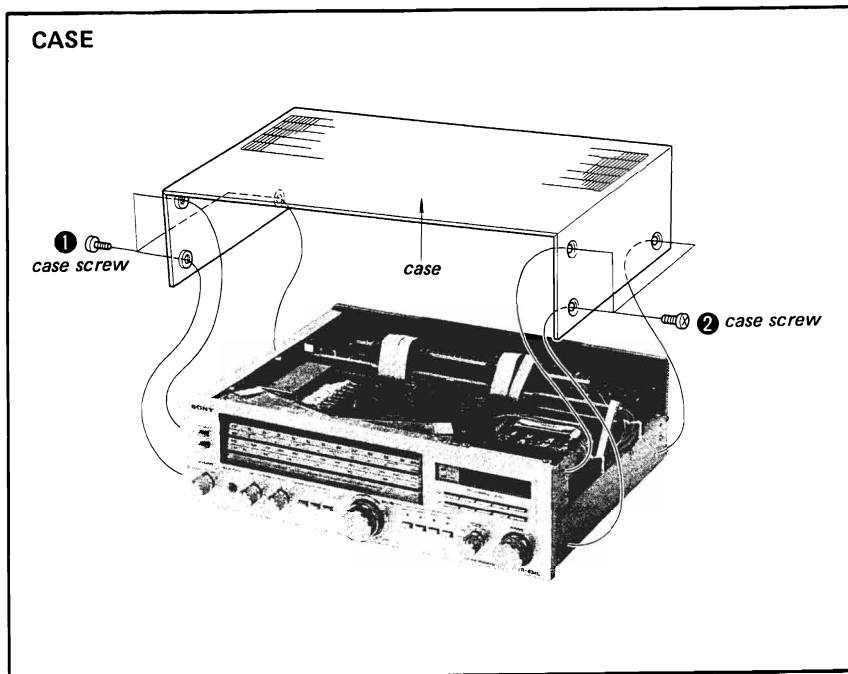



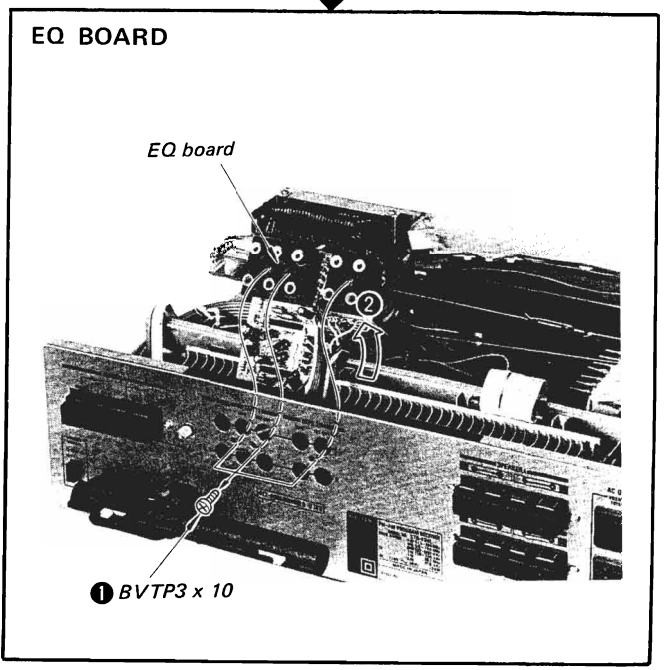
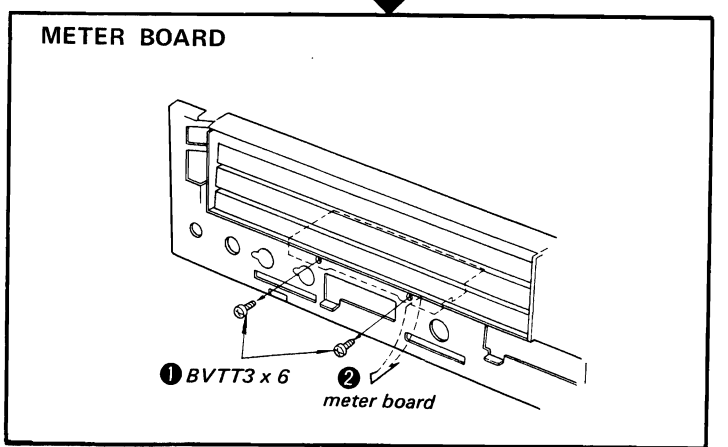
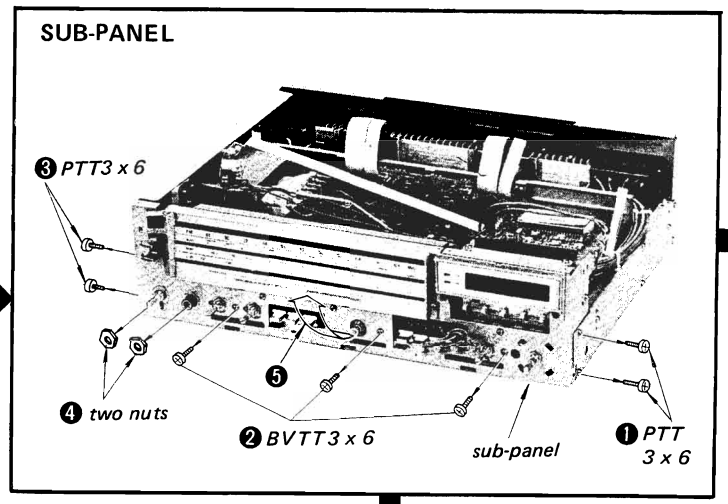
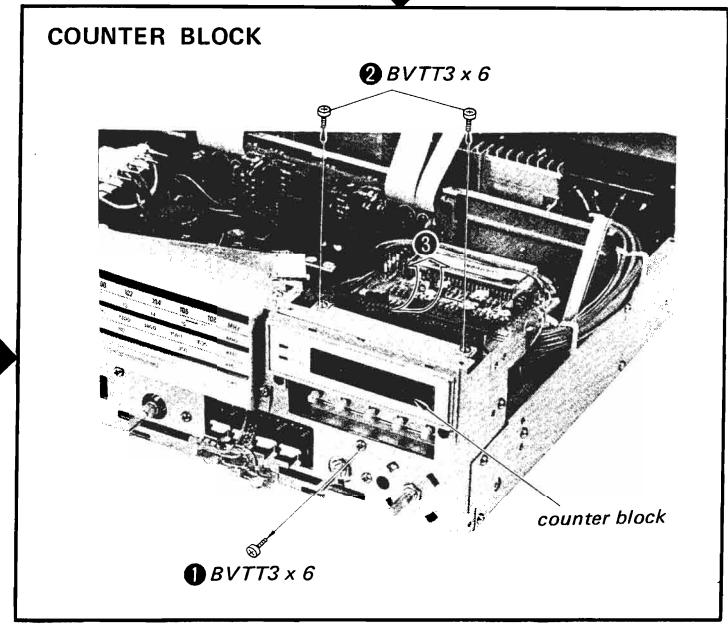
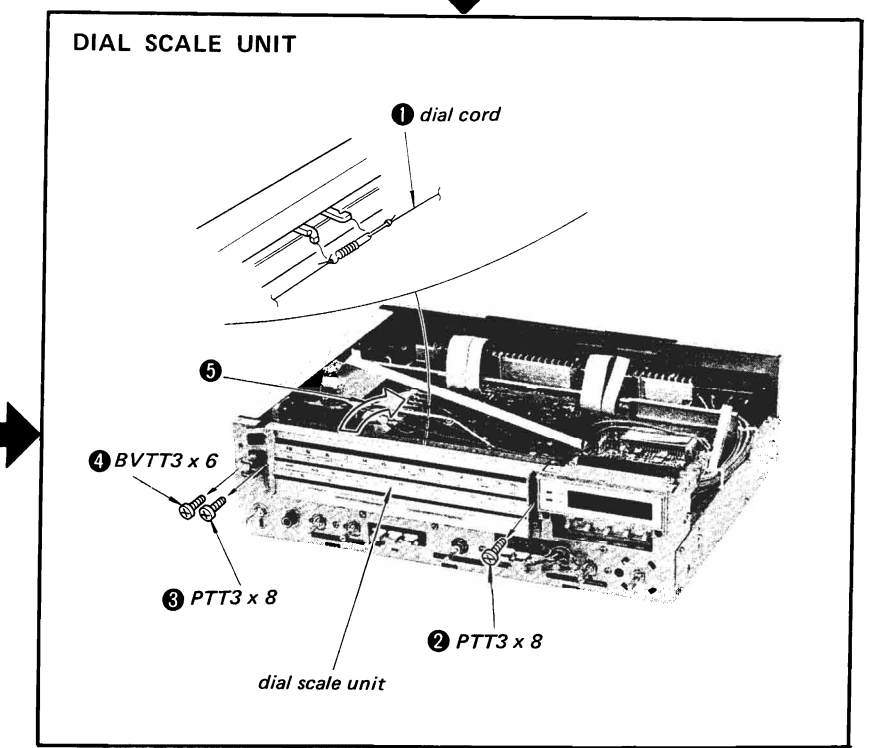
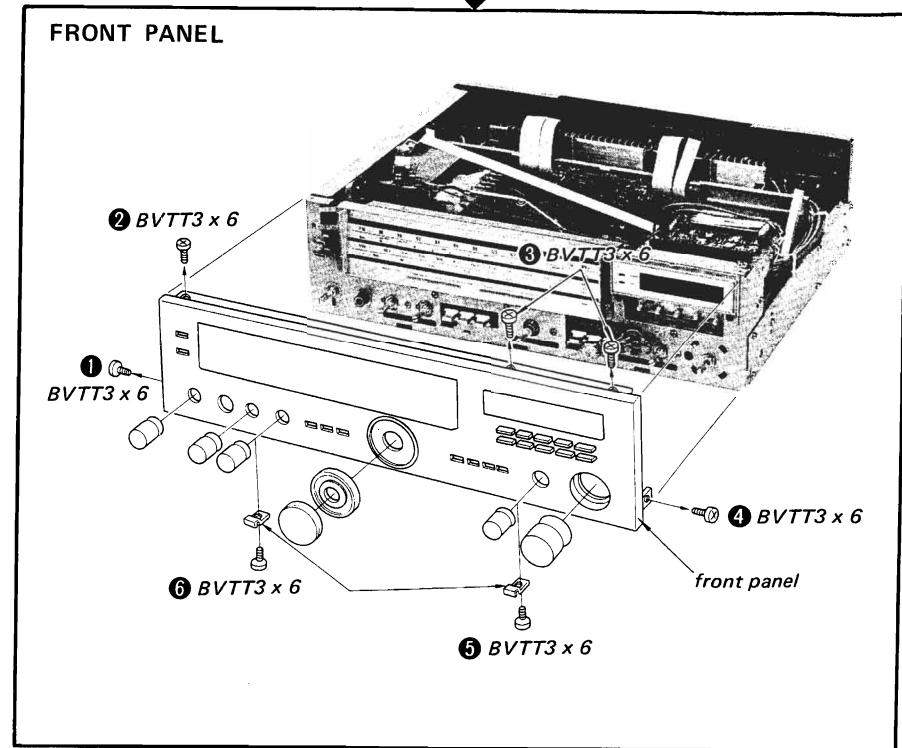
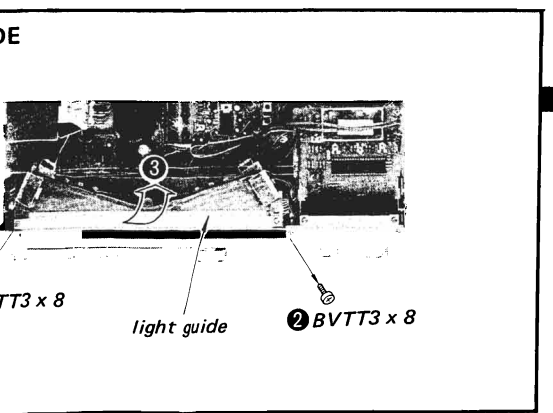
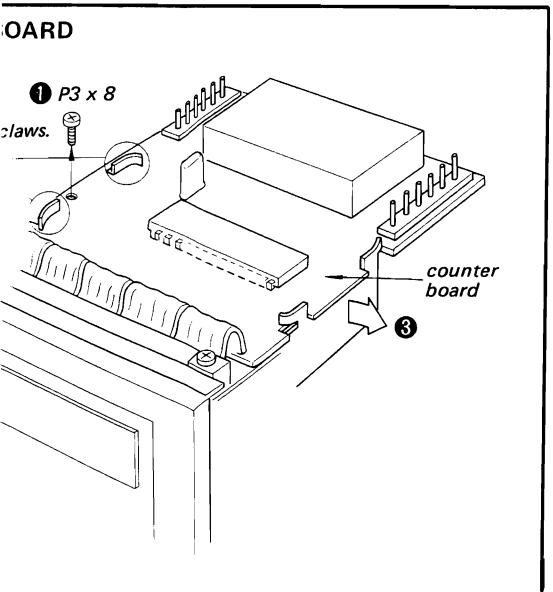

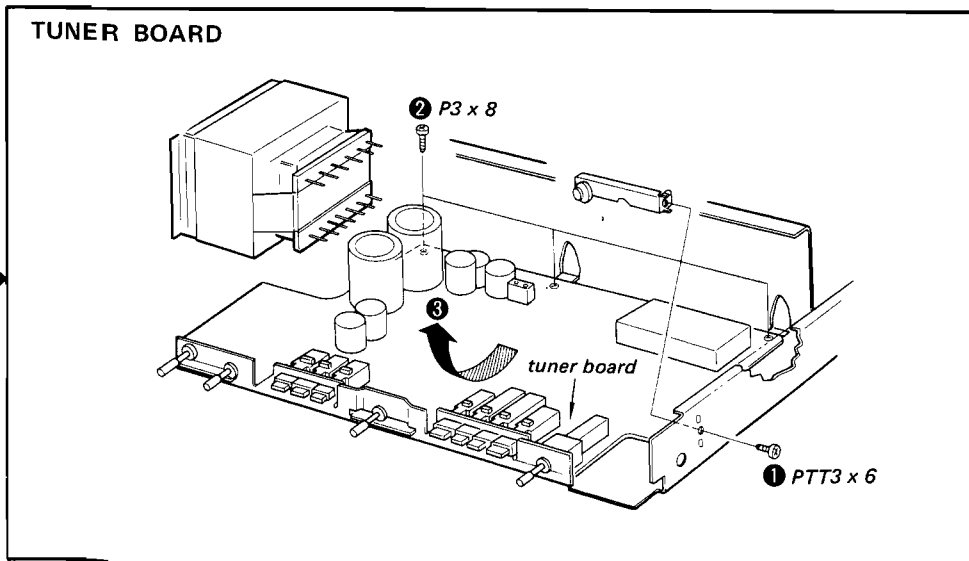
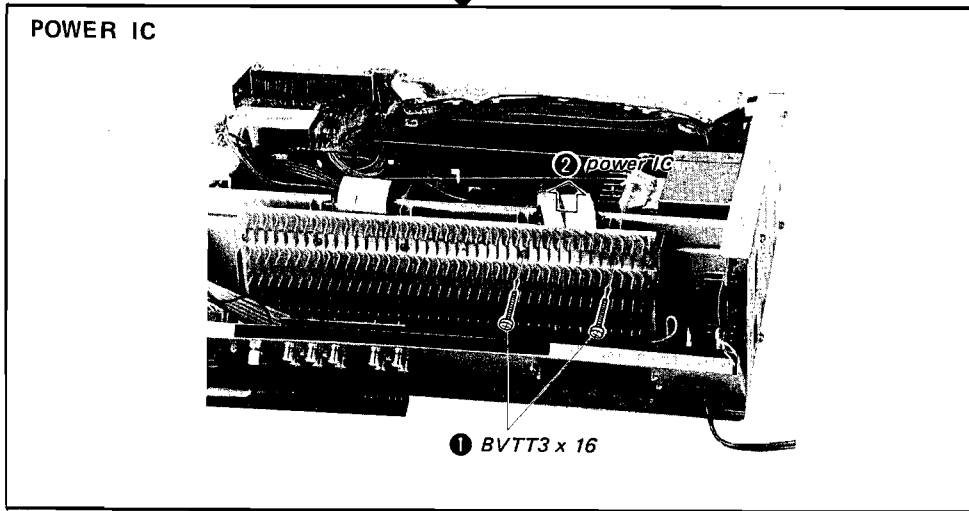
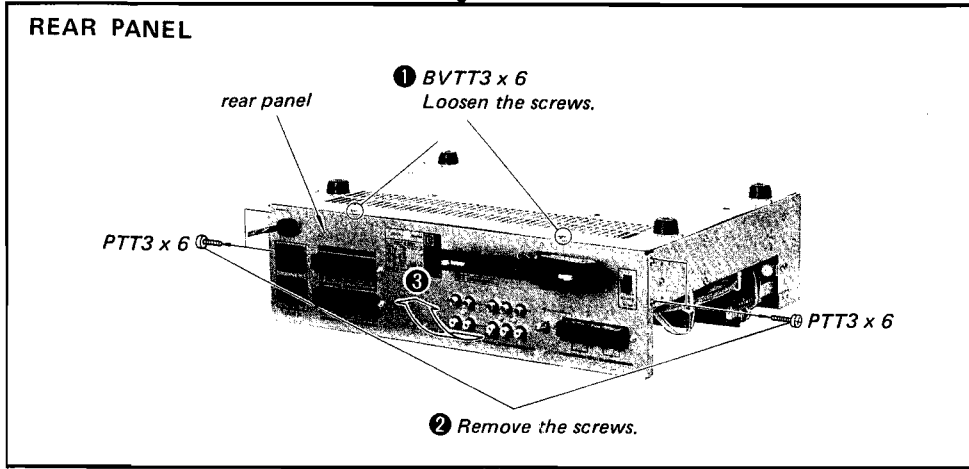

**DIAL SCALE UNIT**

This unit is tuned by moving the sliders of the dial scale unit along the carbon-coated lines of the resistor plates. The sliders should be moved very precisely. So, carefully perform the disassembly and the installation of the dial scale unit as follows. Only the marker and the pointer table are replaceable.

Take care not to damage the sliders shown below.

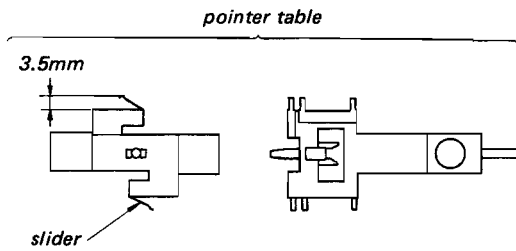
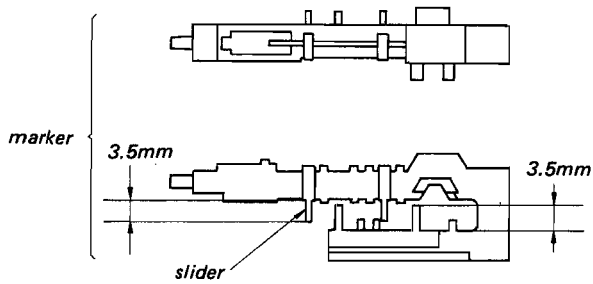

• **Dial Scale Unit Disassembly**

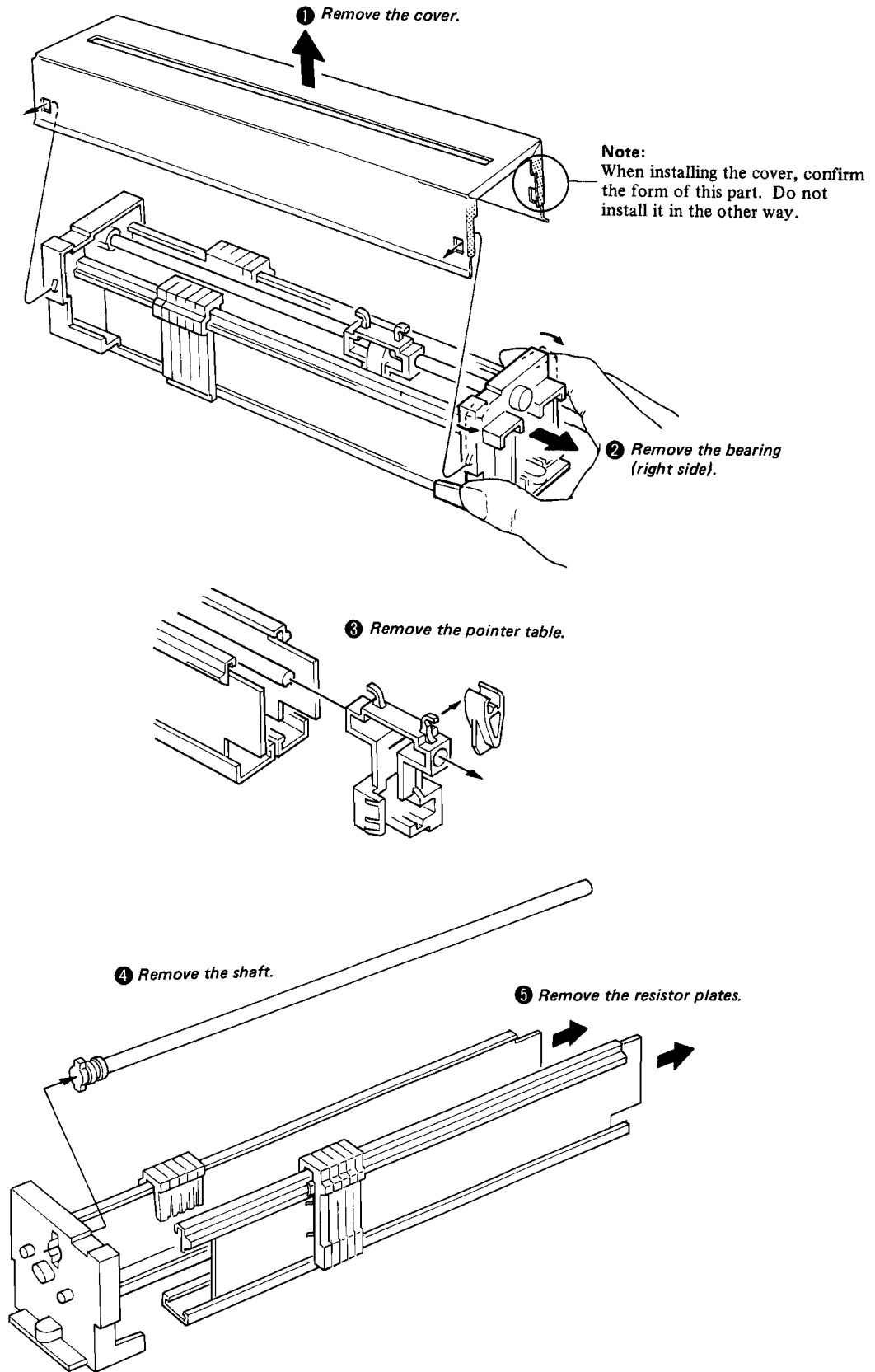

## • Dial Scale Unit Installation

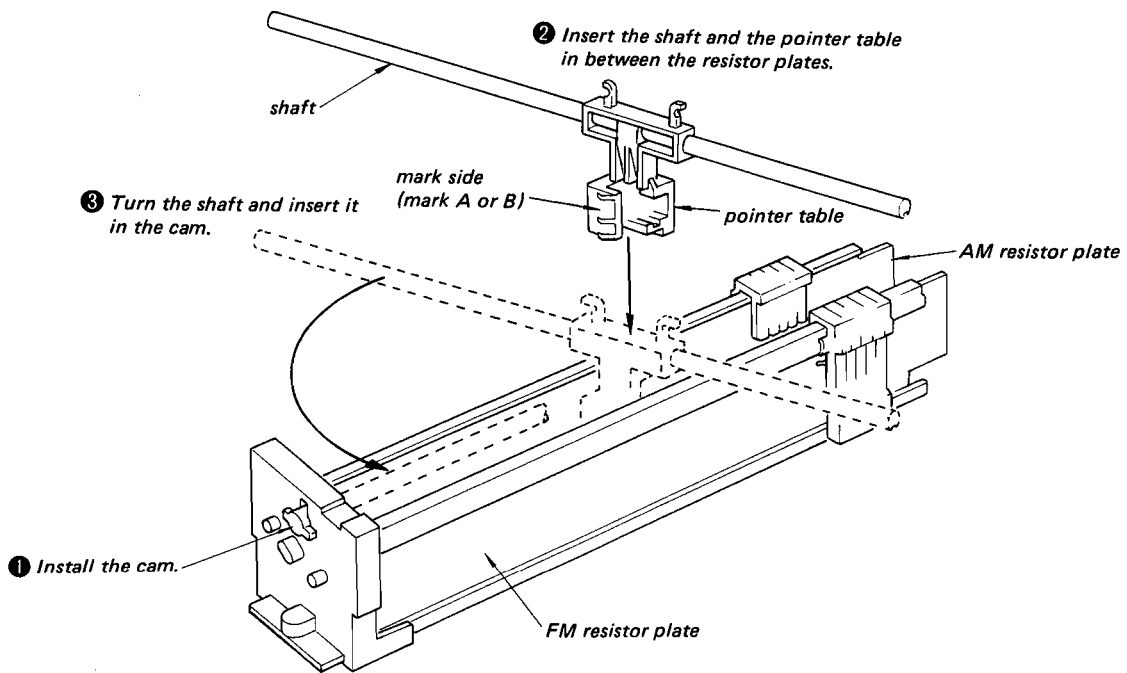

**Note:**  
The installation is performed in this way not to damage the sliders of the pointer table.

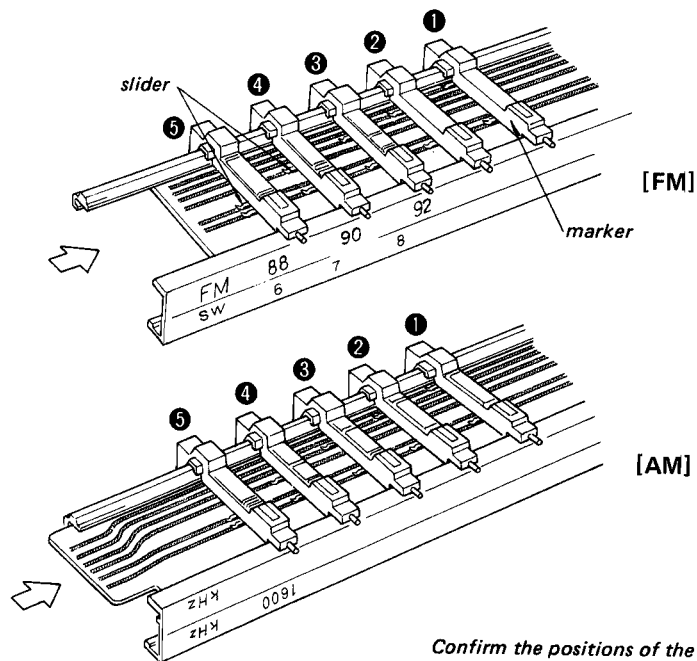

Confirm the positions of the sliders and install the markers in the numerical order given. If one of the markers is damaged, replace the five markers together to obtain the same brightness of them.

DIAL CORD STRINGING

**Note:**  
 Before the dial cord stringing, remove the counter board referring to the pages 10 and 11.

1 Remove the counter board.  
 Prepare a dial cord [0.5mm dia.,  
 1100mm (43 3/8 inches)].

5 Remove the pulley bracket.

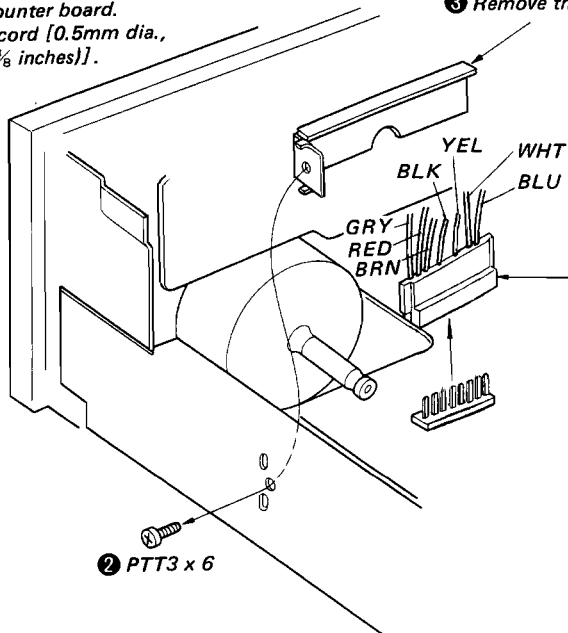

15 Install the pulley bracket and plug in the connector.

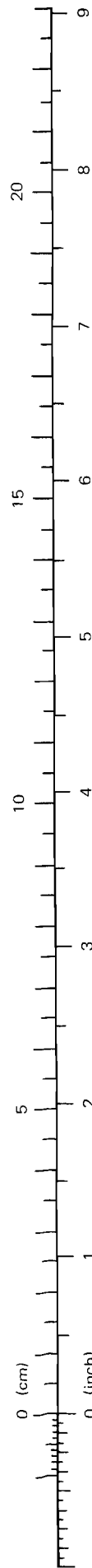
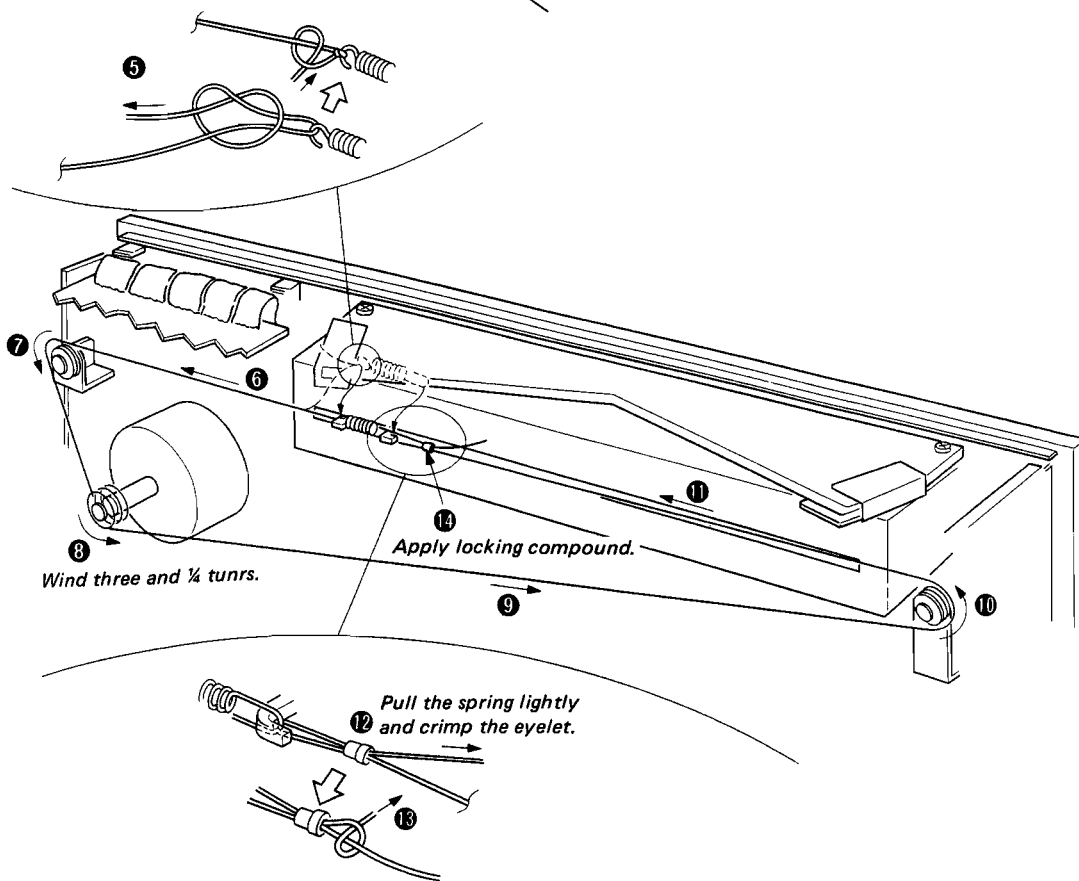

SECTION 3  
ADJUSTMENTS

3-1. AM SECTION

Setting: FUNCTION switch: TUNER  
 Band Selector switch: MW  
 ANTENNA switch: BUILT IN

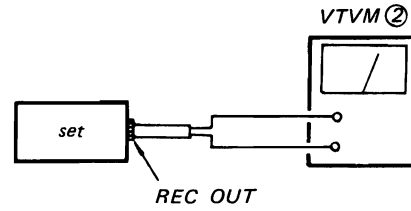
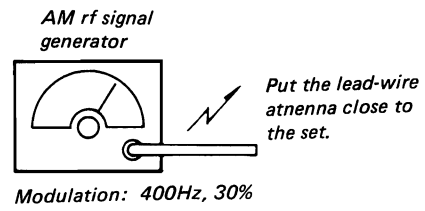

- Repeat the procedures in each adjustment several times, and the frequency coverage and tracking adjustments should be finally done by the trimmer capacitors.

AM IF ALIGNMENT	
Adjust for a maximum reading on VTVM ②.	
450kHz	
T202	T201

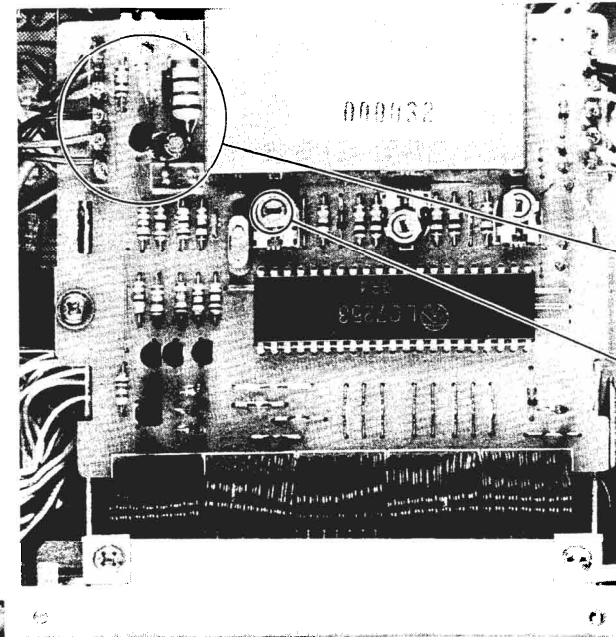

**MW FREQUENCY INDICATION ADJUSTMENT**  
 Setting: AM Rf Signal Generator: 1000 kHz  
 Procedure:

- Set the Band Selector switch to the MW position and connect a 10kΩ carbon resistor as shown below.

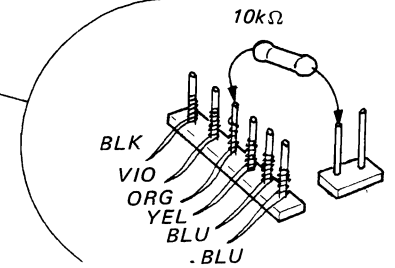

- Tune the unit to the 1000.0kHz signal precisely and adjust RT302 so that the rightmost digit on the display stops flickering.

MW FREQUENCY COVERAGE ADJUSTMENT			
Tuning Control Voltage Adjustment	Dial Indication	VTVM ① Reading	Adjustment Part
	maximum frequency	25V	RT804
	minimum frequency	2V	RT806
Adjust for a specified reading on VTVM ①.			
Local Oscillator Frequency Adjustment	Dial Indication	AM Rf Signal Generator Frequency	Adjustment Part
	minimum frequency	515kHz	T205
	maximum frequency	1660kHz	CT204
Adjust for a maximum reading on VTVM ②.			
Dial Pointer Setting	Dial Indication	AM Rf Signal Generator Frequency	Adjustment Part
	600kHz	600kHz	RT804
	1000kHz	1000kHz	RT805
	1400kHz	1400kHz	RT806
Adjust for a maximum reading on VTVM ②.			
Note: Be sure to perform the LW and the SW frequency coverage adjustments after the tuning control voltage adjustment.			

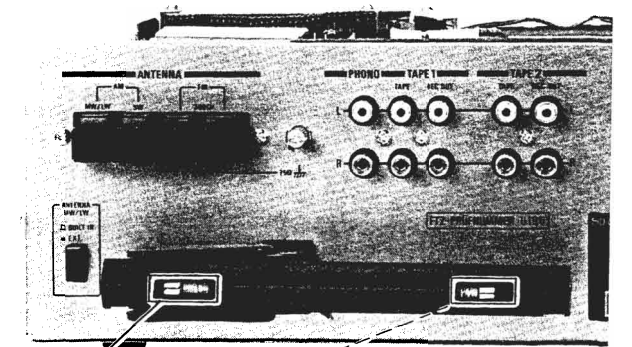
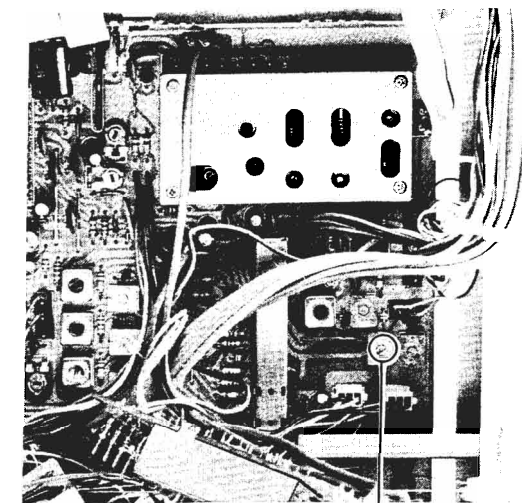
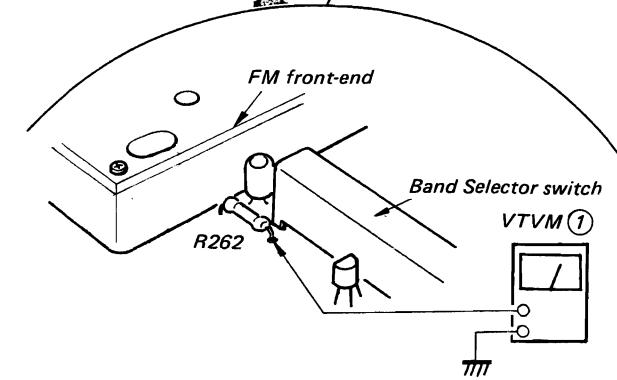
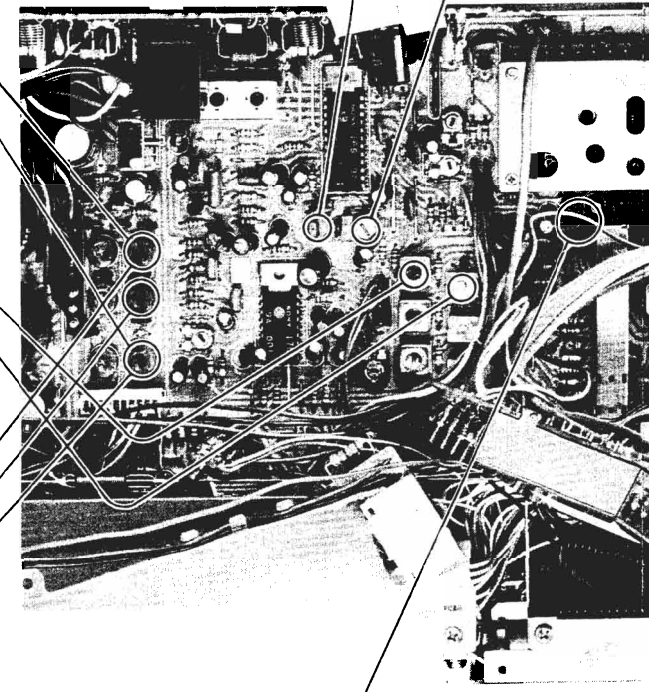

AEP model: Serial No. 501,001 and later  
 AEP model: Serial No. 500,000 - 501,001  
 US model  
 SCN model

MW TRACKING ADJUSTMENT	
Adjust for a maximum reading on VTVM ②.	
L901-1	600kHz
CT201	1,400kHz

Setting: FUNCTION switch TUNER  
 Band Selector switch: LW  
 ANTENNA switch: BUILT IN

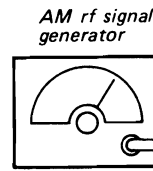

Put the lead-wire antenna close to the set.

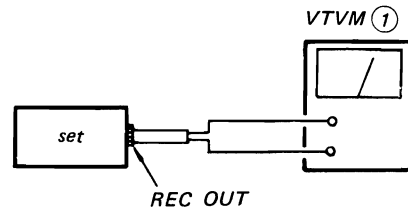

• Repeat the procedures in each adjustment several times, and the frequency coverage and tracking adjustments should be finally done by the trimmer capacitors.

MW/LW EXT ANTENNA COIL ADJUSTMENT

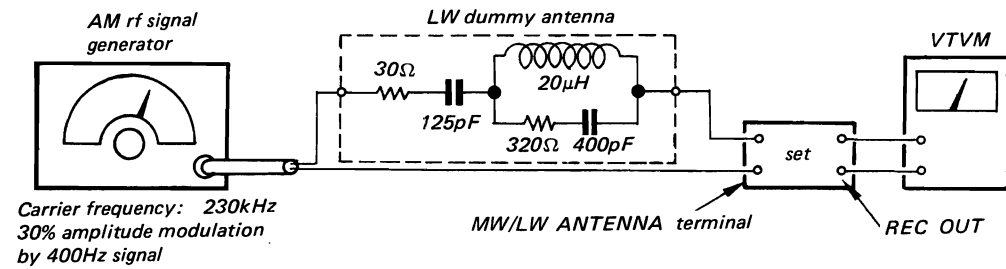

1. Set the ANTENNA switch to EXT position.
2. Tune the set to 230kHz and adjust T204 for a maximum reading on VTVM .

T204

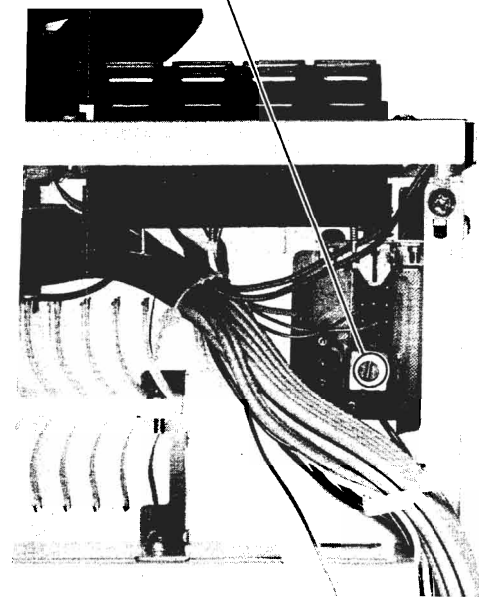

LW FREQUENCY COVERAGE ADJUSTMENT	
Adjust for a maximum reading on VTVM ① .	
145kHz	T207
365kHz	CT206

Note: Before this adjustment, perform the MW frequency coverage adjustment.

AEP model: Serial No. 501,000 and later

AEP model: Serial No. 500,000 - 501,001  
 UK model  
 SCN model

L901-2	170kHz
CT203	310kHz
Adjust for a maximum reading on VTVM ① .	
LW TRACKING ADJUSTMENT	

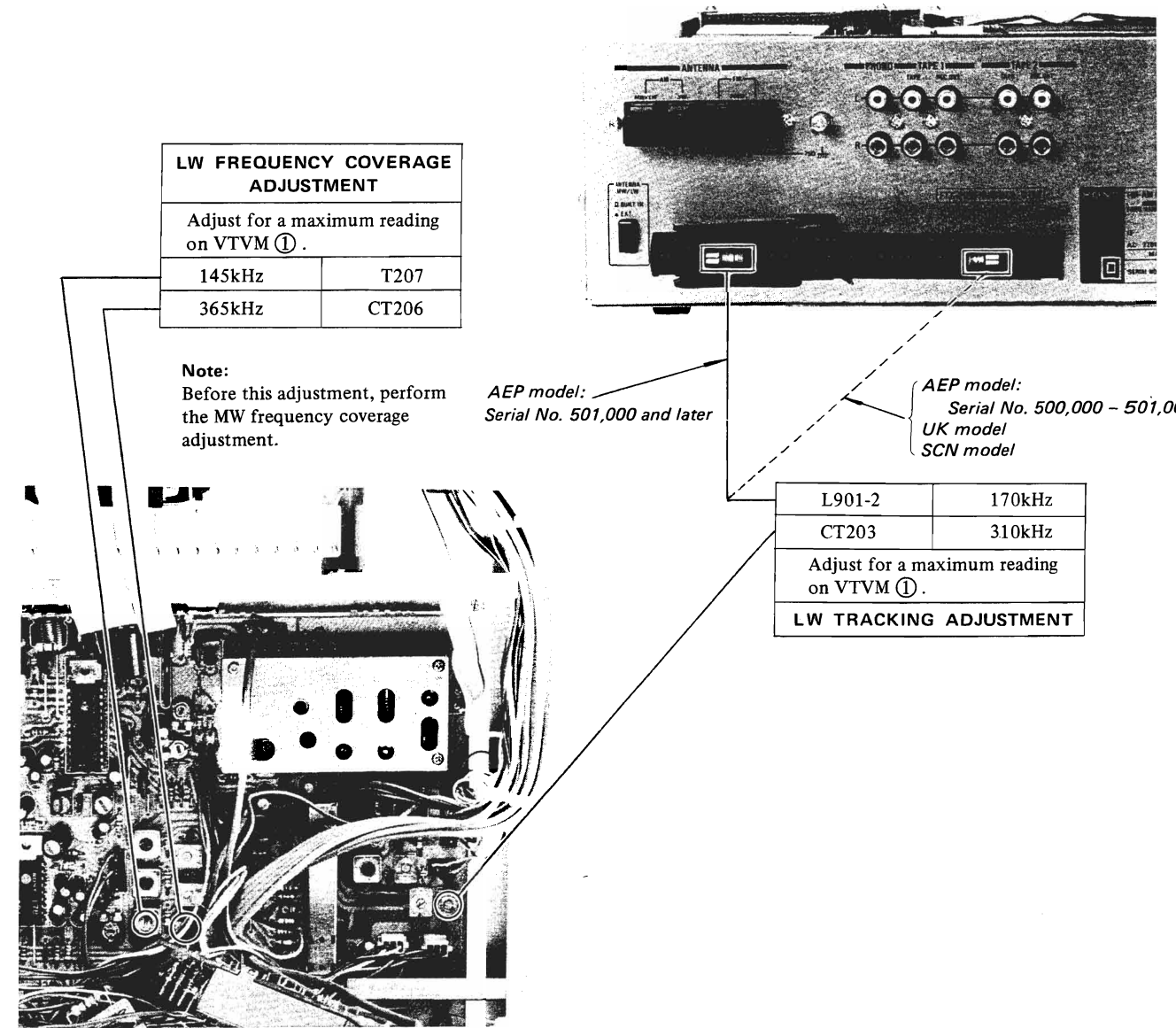



Setting: FUNCTION switch: TUNER  
Band Selector switch: SW

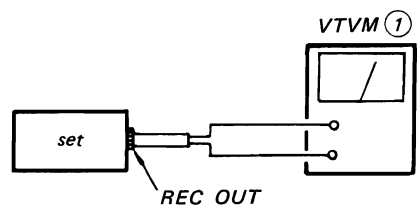
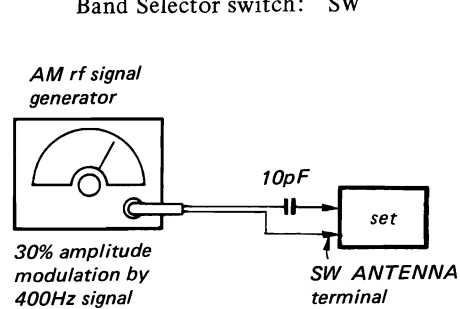

• Repeat the procedures in each adjustment several times, and the frequency coverage and tracking adjustments should be finally done by the trimmer capacitors.

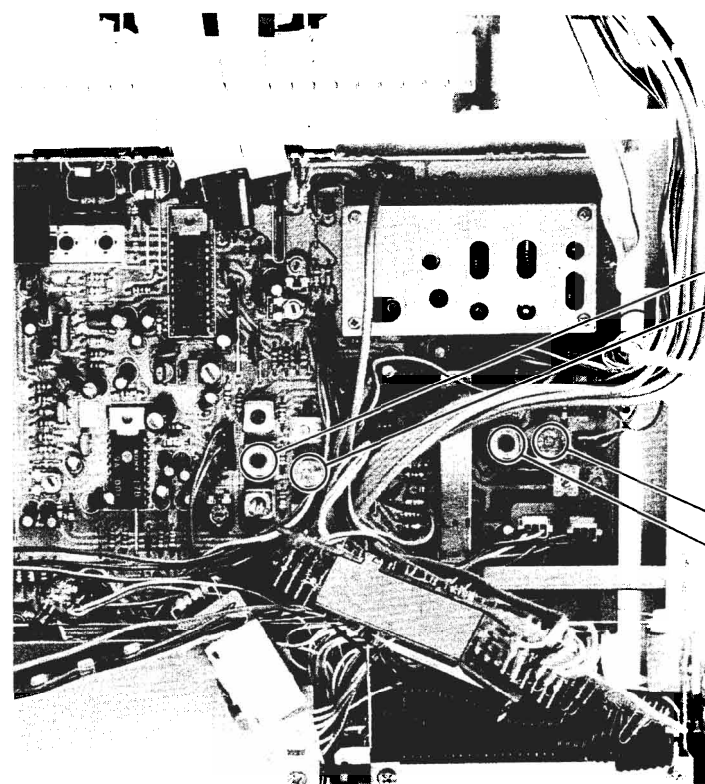

SW FREQUENCY COVERAGE ADJUSTMENT	
Adjust for a maximum reading on VTVM ①.	
T206	5.5MHz
CT205	16.1MHz

**Note:**  
Before this adjustment, perform the MW frequency coverage adjustment.

SW TRACKING ADJUSTMENT	
Adjust for a maximum reading on VTVM ①.	
CT202	16.1MHz
T203	5.5MHz

**SW FREQUENCY INDICATION ADJUSTMENT**

Setting: AM Rf Signal Generator: 10,000 MHz

Procedure:

1. Set the Band Selector switch to the SW position and connect a 10kΩ carbon resistor as shown below.
2. Tune the unit to the 10.000MHz signal precisely and adjust RT303 so that the rightmost digit on the display stops flickering.

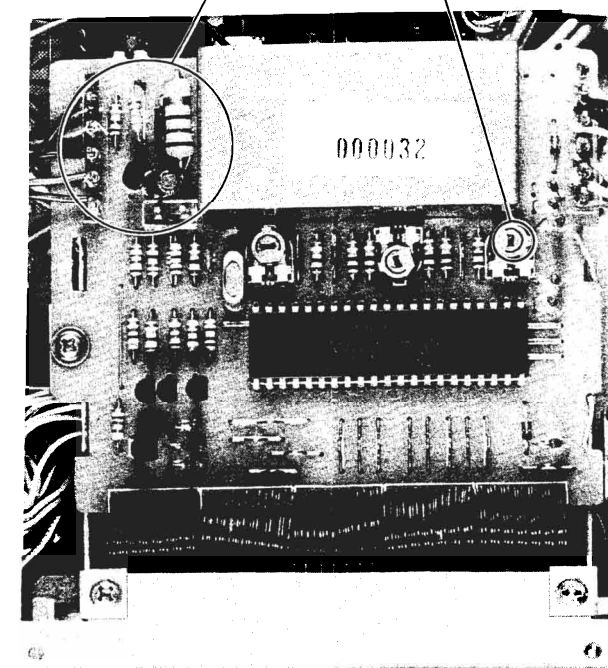
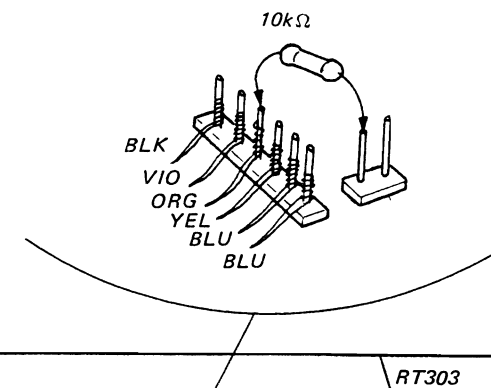

3-2. FM SECTION

**FM DISCRIMINATOR ALIGNMENT 2**

**Setting:** FUNCTION switch: TUNER  
 Band Selector switch: FM  
 MODE switch: MONO

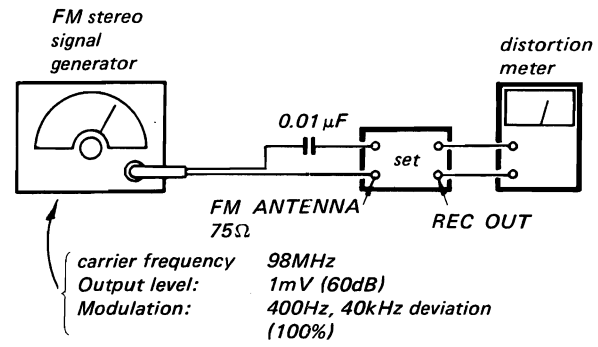

**Procedure:**  
 Adjust the black core (secondary side) of IFT201 for minimum distortion.

**FM IF ALIGNMENT**

**Setting:** FUNCTION switch: TUNER  
 Band Selector switch: FM  
 MODE switch: MONO

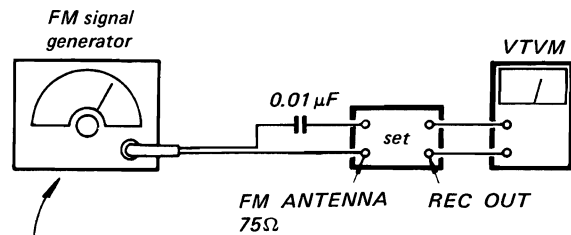

Carrier frequency: 98MHz  
 Output level: 12.5μV (22dB)  
 Modulation: 400Hz, 40kHz deviation (100%)

**Procedure:**  
 Adjust T5 for a maximum reading on VTVM.

**FM DISCRIMINATOR ALIGNMENT 1**

**Setting:** FUNCTION switch: TUNER  
 Band Selector switch: FM  
 MODE switch: MONO  
 TUNING: Detuned position

**Procedure:**  
 Adjust the orange core (primary-side) of IFT201 for 0V reading on VOM.

**Note:** When replacing the ceramic filter (CF201), perform this alignment.

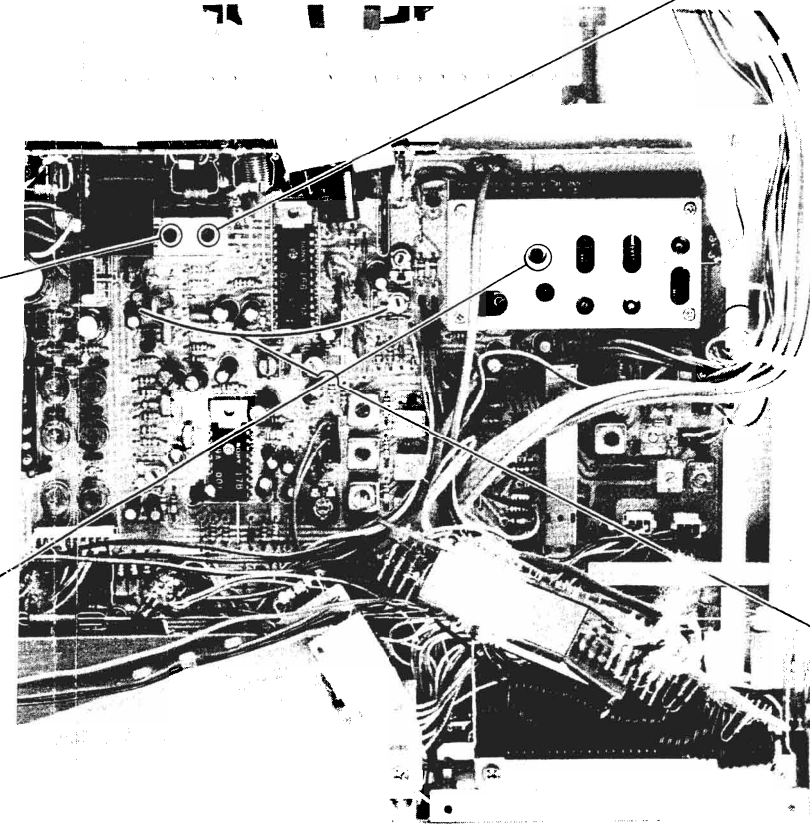

IFT201

IFT201

T5

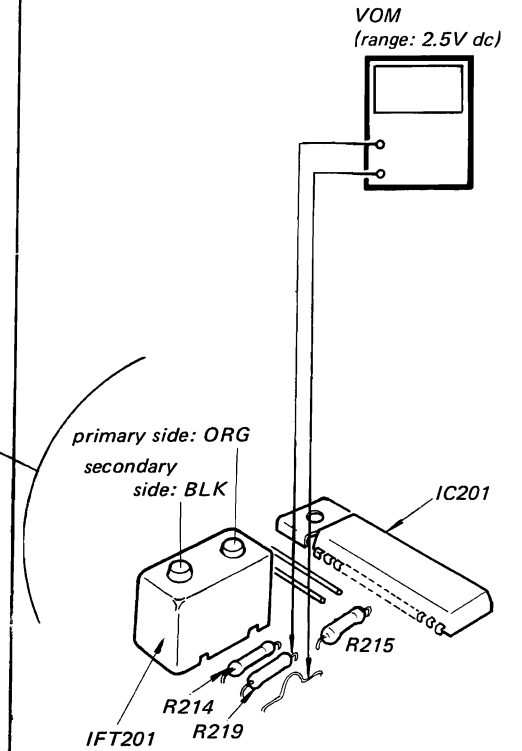

Setting: FUNCTION switch: TUNER  
 Band Selector switch: FM  
 MODE Selector: MONO

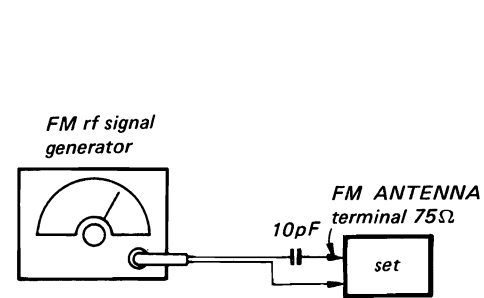

Modulation: 400Hz, 40kHz deviation (100%)

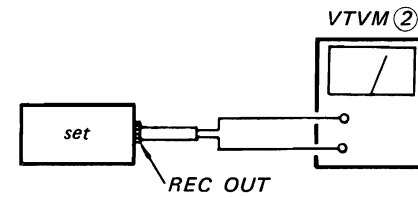

• Repeat the procedures in each adjustment several times, and the frequency coverage and tracking adjustments should be finally done by the trimmer capacitors.

FM TRACKING ADJUSTMENT	
Adjust for a maximum reading on VTVM ② .	
T3	88MHz
T2	
T1	
CT1	108MHz
CT2	
CT3	

FM FREQUENCY INDICATION ADJUSTMENT

Setting: FM Rf Signal Generator: 98.0 MHz

Procedure:

1. Set the Band Selector switch to the FM position and connect a lead wire as shown below.

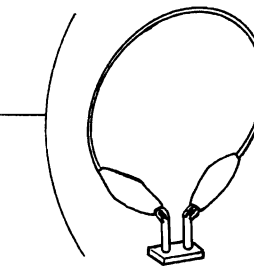

2. Tune the unit to the 98.0MHz signal precisely and adjust RT301 so that the rightmost digit on the display stops flickering.

FM FREQUENCY COVERAGE ADJUSTMENT			
Tuning Control Voltage Adjustment	Dial Indication	VTVM ① Reading	Adjustment Part
	maximum frequency	22.08V	RT801
	minimum frequency	2.73V	RT803
Adjust for a specified reading on VTVM ① .			
Local Oscillator Frequency Adjustment	Dial Indication	FM Rf Signal Generator Frequency	Adjustment Part
	minimum frequency	88MHz	T4
	maximum frequency	108MHz	CT4
Adjust for a maximum reading on VTVM ② .			
Dial Pointer Setting	Dial Indication	FM Rf Signal Generator Frequency	Adjustment Part
	98MHz	98MHz	RT802
Adjust for a maximum reading on VTVM ② .			

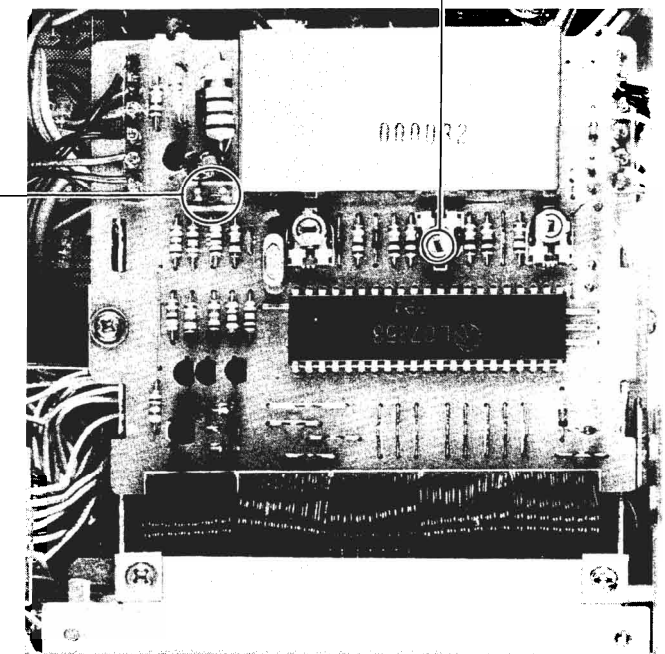
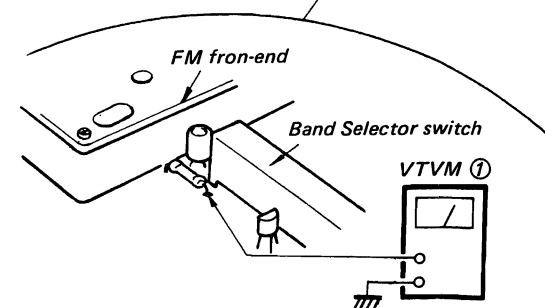
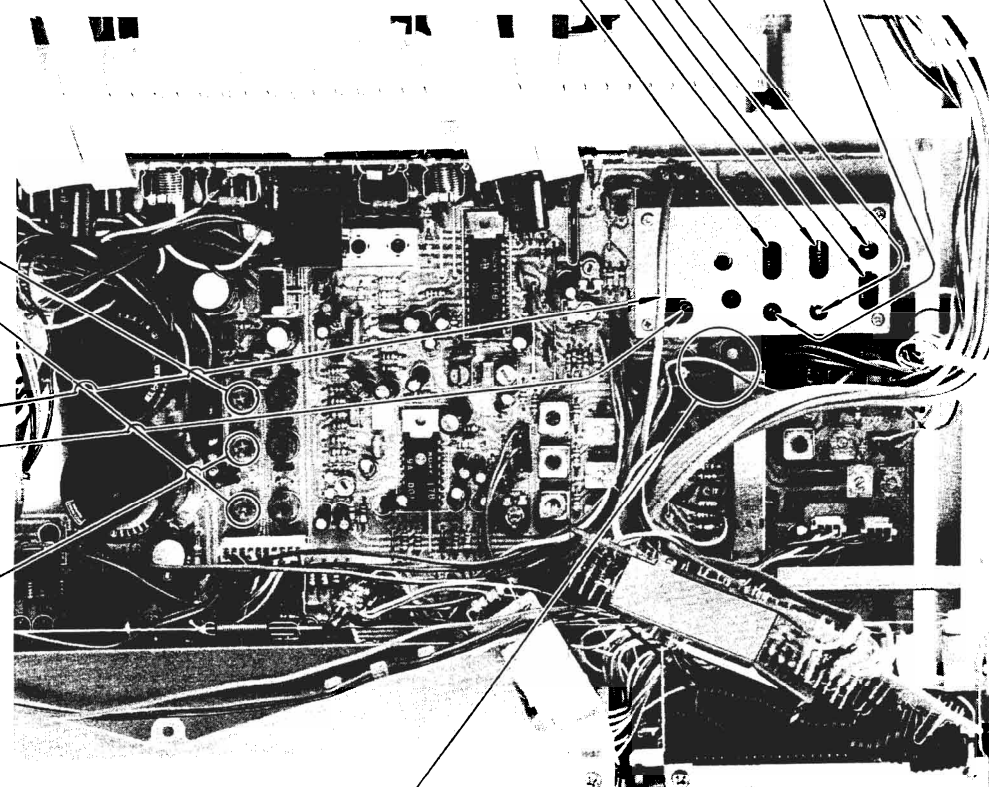

### VCO ADJUSTMENT

**Setting:** FUNCTION switch: TUNER  
Band Selector switch: FM  
MODE switch: STEREO/FM-AM MUTING

**A) Regular Method**

FM stereo signal generator

Carrier frequency: 98MHz  
Output level: 1mV  
Modulation: no modulation

FM ANTENNA terminal 75Ω

**Procedure:**  
Adjust RT204 for 76kHz ±100Hz on the frequency counter.

frequency counter

**B) Simple Method**

**Procedure:**

1. Turn the set to the FM stereo broadcasting signal.
2. Turn RT204 clockwise or counterclockwise and memorize the lighting-up range of STEREO lamp.
3. Secure at the center in lighting-up range of both turns as shown below.

center of lighting-up ranges  
lighting-up range

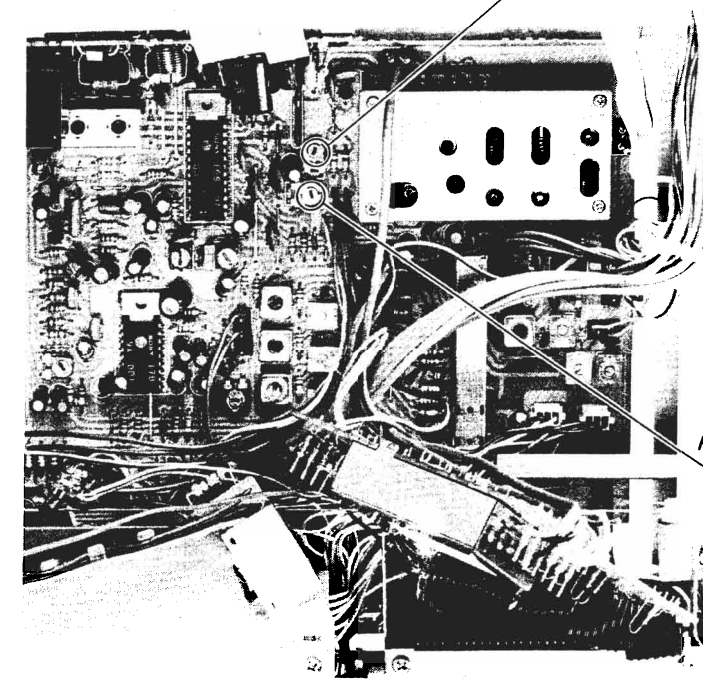
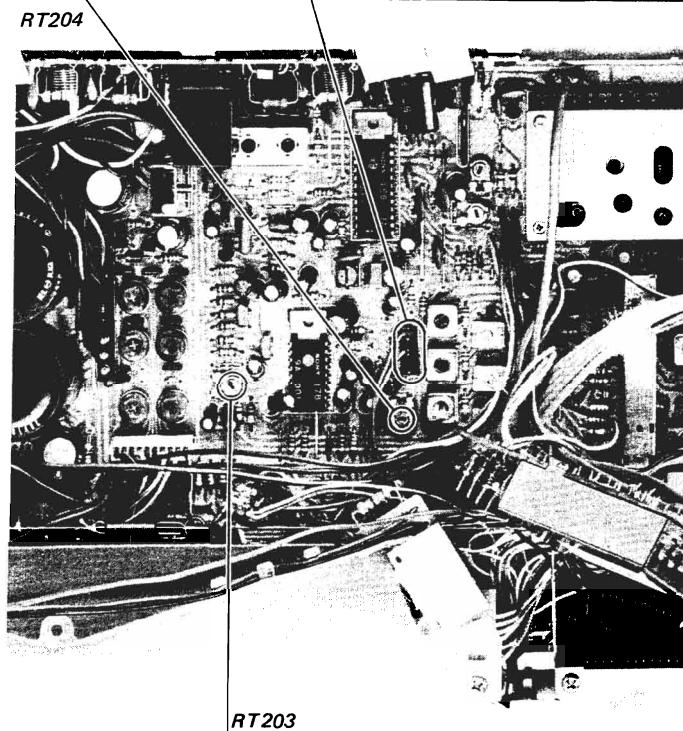

### MUTING LEVEL ADJUSTMENT

**Setting:** FUNCTION switch: TUNER  
Band Selector switch: FM  
MODE switch: STEREO/FM-AM MUTING

**Procedure:**

FM rf signal generator

Carrier frequency: 98MHz  
Modulation: 400Hz, 40kHz deviation (100%)  
Output level: 16μV (22dB)

Turn RT201 and stop it just when the VOM indication suddenly decreases.

### SIGNAL METER CALIBRATION

**Setting:** FUNCTION switch: TUNER  
Band Selector switch: FM

FM rf signal generator

Carrier frequency: 98MHz  
Modulation: 400Hz, 40kHz deviation (100%)

**Procedure:**  
Adjust RT202 for the specified meter indication.

Generator Output Level	Meter Indication
100μV (40dB)	Light.  SIGNAL
1000μV (60dB)	Light.  SIGNAL

### FM STEREO SEPARATION ADJUSTMENT

**Setting:** FUNCTION switch: TUNER  
Band Selector switch: FM  
MODE switch: STEREO/FM-AM MUTING

FM stereo signal generator

Carrier frequency: 98MHz  
Output level: 1mV (60dB)  
Modulation:  
Audio (400Hz): 20kHz deviation (50%)  
Pilot (19kHz): 6.3kHz deviation (16%)  
Sub channel (38kHz): 20kHz deviation (50%)

FM ANTENNA 75Ω REC OUT

**Procedure:**

FM stereo signal generator output channel	VTVM connection	VTVM reading (dB)
L-CH	L-CH	(A)
R-CH	L-CH	(B)
R-CH	R-CH	(C)
L-CH	R-CH	(D)

Adjust RT203 resistor for minimum reading.

L-CH Stereo separation: (A) - (B)  
R-CH Stereo separation: (C) - (D)

The separations of both channels should be equal.

The difference between separations (A) - (B) and (C) - (D) are to be equal.

**POWER LEVEL METER BRIGHTNESS ADJUSTMENT**

**Procedure:**

Adjust RT701 for the same brightness of L-CH and R-CH power level meters.

**Adjustment Location:** meter board

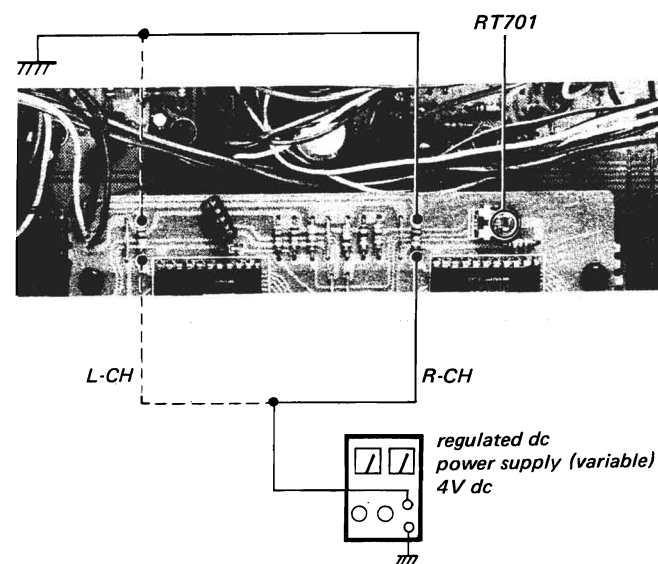

**POWER LEVEL METER CALIBRATION**

**Setting:** FUNCTION switch: TAPE 1  
MODE switch: STEREO/FM-AM  
MUTING

**Procedure:**

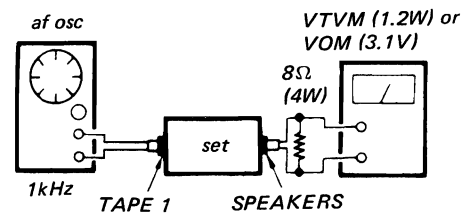

1. Adjust the VOL and the BAL controls for a 1.2W VTVM reading or a 3.1V VOM reading. (for both channels)
2. Adjust RT601 (L-CH) and RT651 (R-CH) so that the power level meter indicates 1.2W.

**Adjustment Location:** power amp board

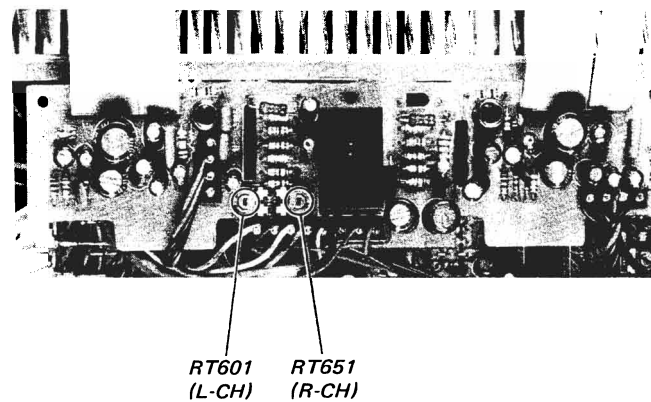

**Replacement Semiconductors**

For replacement, use semiconductors except in ( ).

Q201-203, 213, 301, 307, 308, 802 : 2SC1364 (2SC1815)  
Q204 : 2SC1345

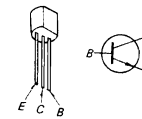

IC301: LC7253

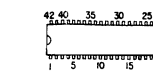

(Top view)

IC302: MSL2318RS

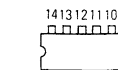

(Top view)

IC401, 451 : HA1457  
IC501, 551

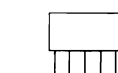

(Marking side view)

Q205-211, 302-305, 803 : 2SA1015

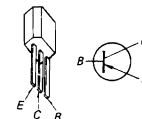

Q306: 2SC710

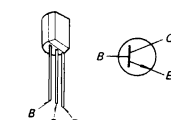

Q801: 2SC1173

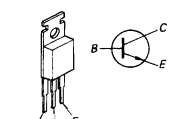

Q804: 2SC1475 (2SD571)

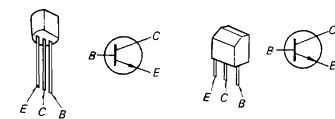

Q805: 2SB605

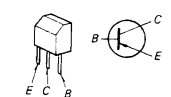

IC201: CX168

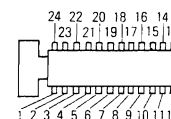

(Top view)

IC202: CX178

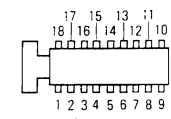

(Top view)

IC701, 751: IR2406G

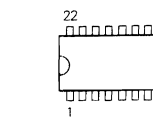

(Top view)

D201, 202: ISV118

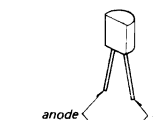

D203-215, 301-313, 813-815, 907, 908 : 1S1555

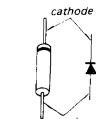

D314, 808 : EQB01-05 (EQA01-05R)  
D315 : EQB01-09 (EQA01-09R)  
D807 : EQB01-16 (EQA01-16R)  
D809, 810 : EQB01-22 (EQA01-22R)

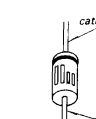

D601, 602, 806: 10E2 (RA1Z)

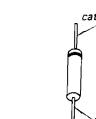

D801-804: U05G (S2V20)

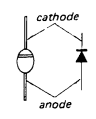

IC602: HA12002

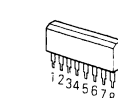

IC603: TA7318P

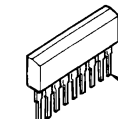

D805: SIVB20 (SIVB10)

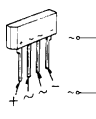

D901: GL9PR21  
D902: GL9NG21

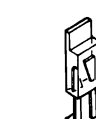

D903-906: GL2HY1

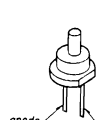

4-1. MOUNTING DIAGRAM  
- Conductor Side -

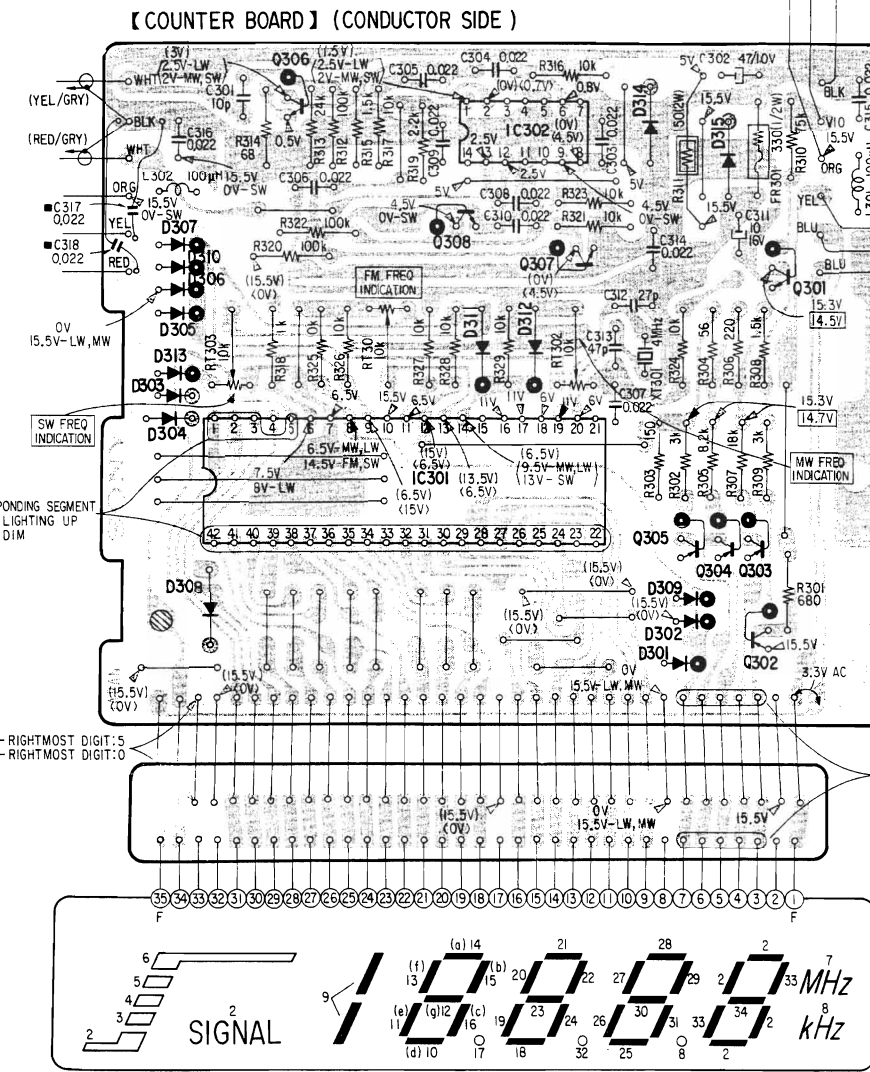
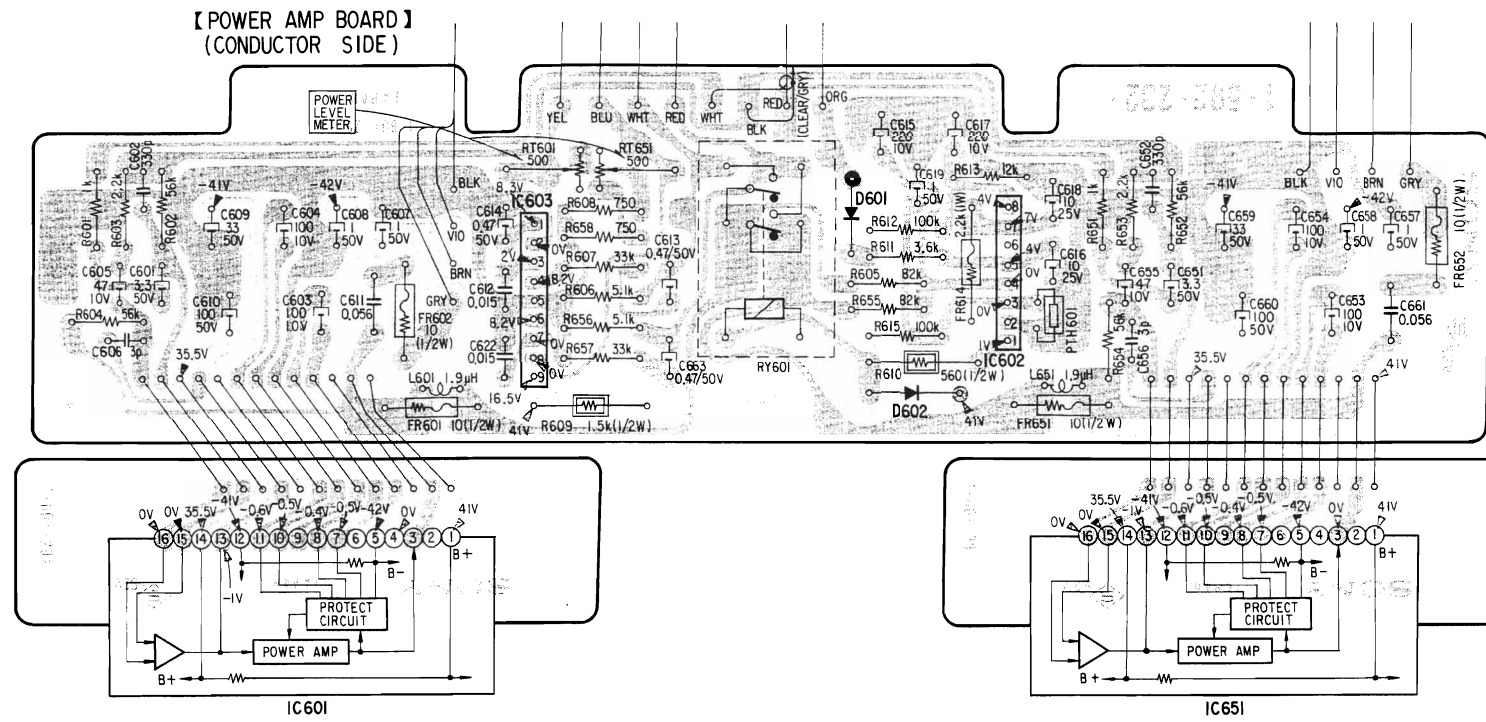

Q, IC	D
306	314
IC302	315
308	307
307	310
301	306
	305
	311,312
	313
	303
	304
IC301	
303-305	
302	309
	302
	301

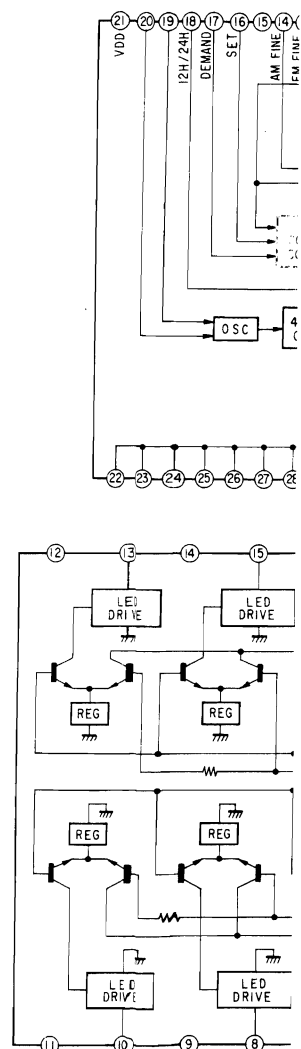

Note:  
● Color code of sleeving over the end of the jacket.

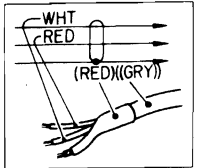

- — : parts extracted from the component side.
- — : parts extracted from the conductor side.
- — : part mounted on the conductor side.
- ■ : B+ pattern.

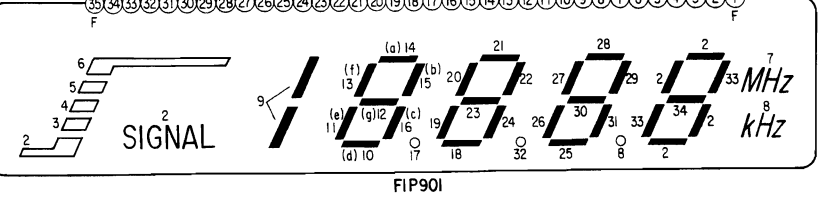
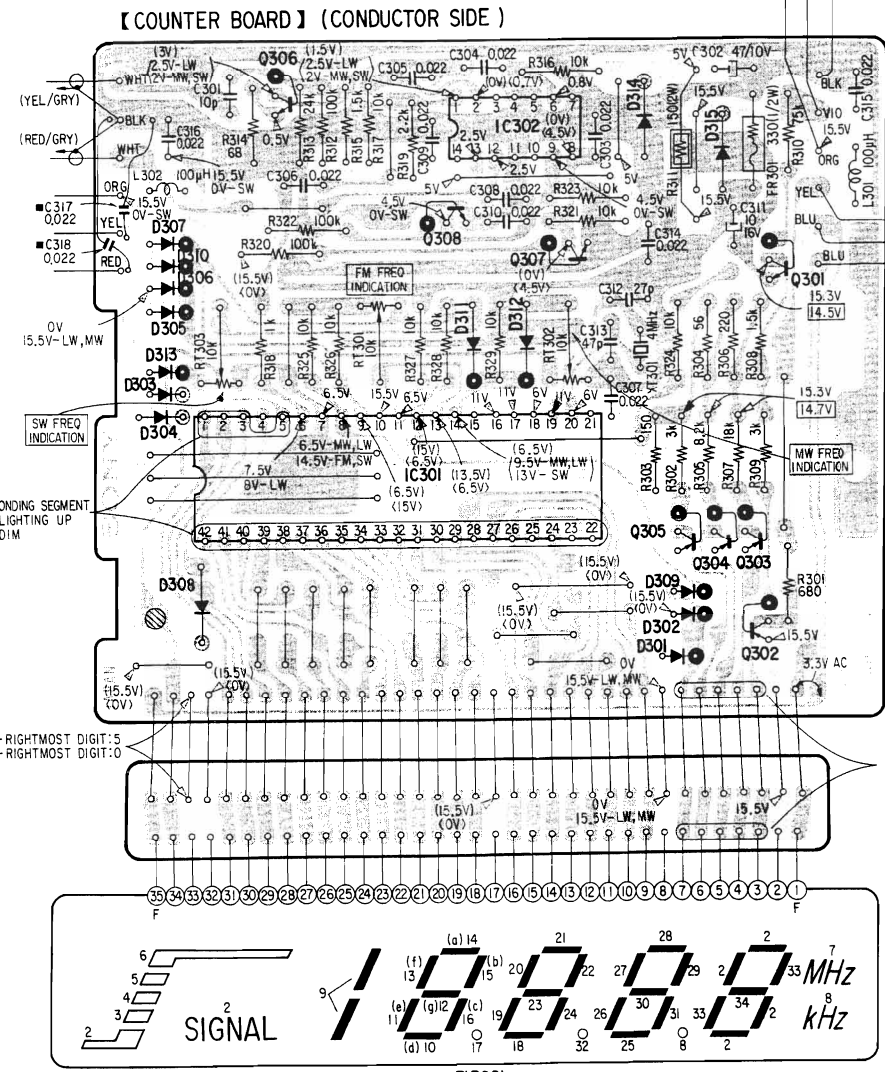
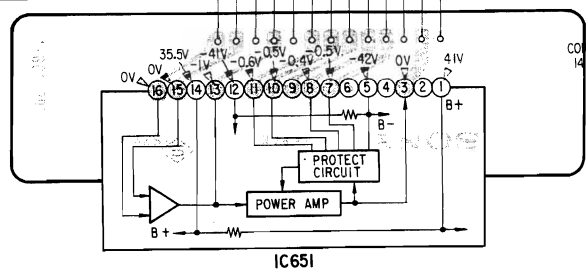
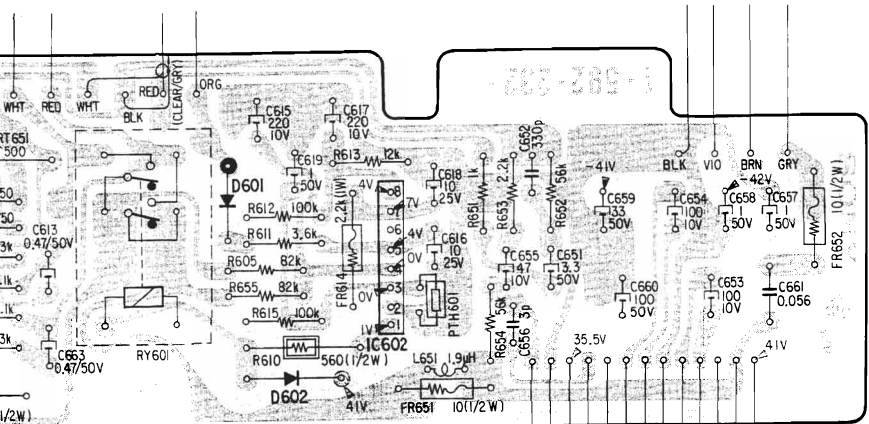

Q, IC	D
306	314
IC302	315
308	307
307	310
301	306
305	305
	311,312
	313
	303
	304
IC301	
303-305	
308	309
302	302
	301

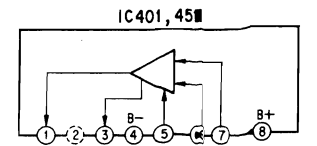
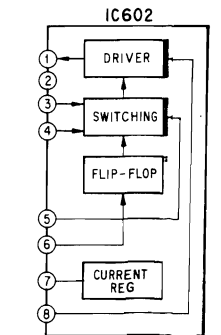
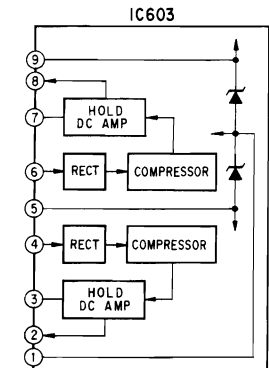
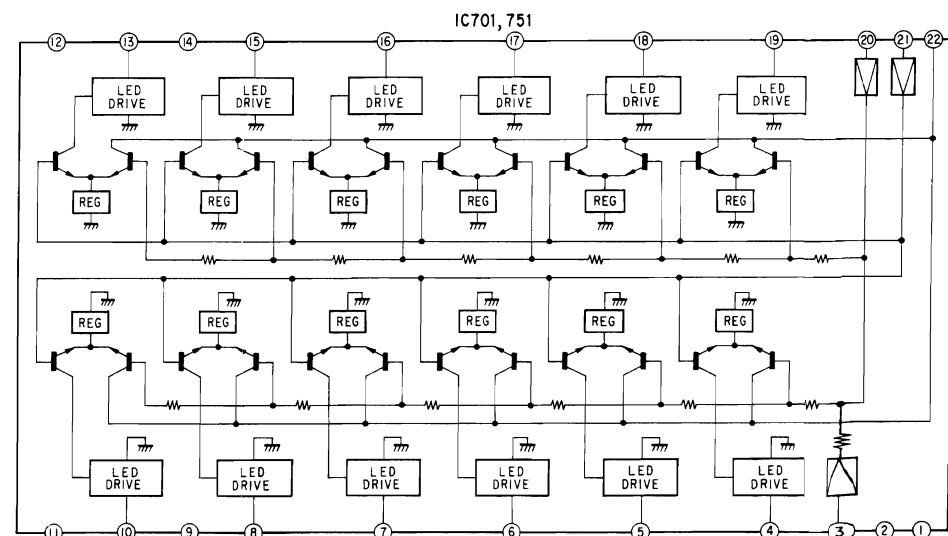
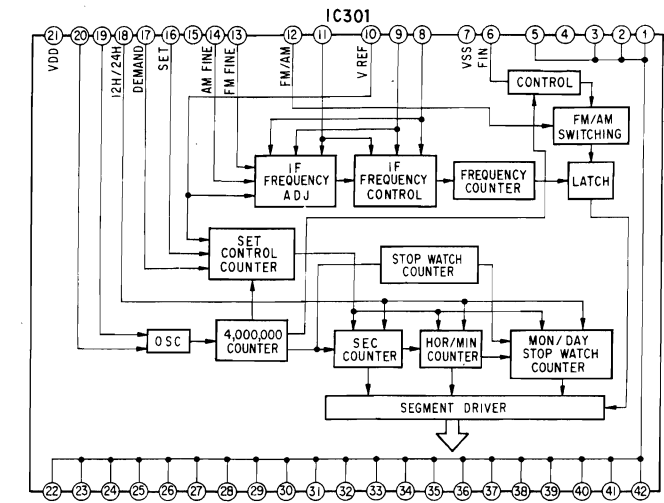
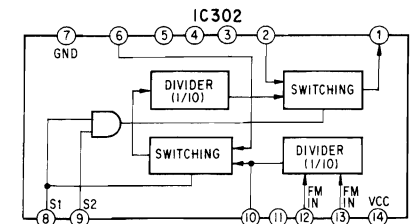

the jacket.  
onent side.  
ector side.  
r side.

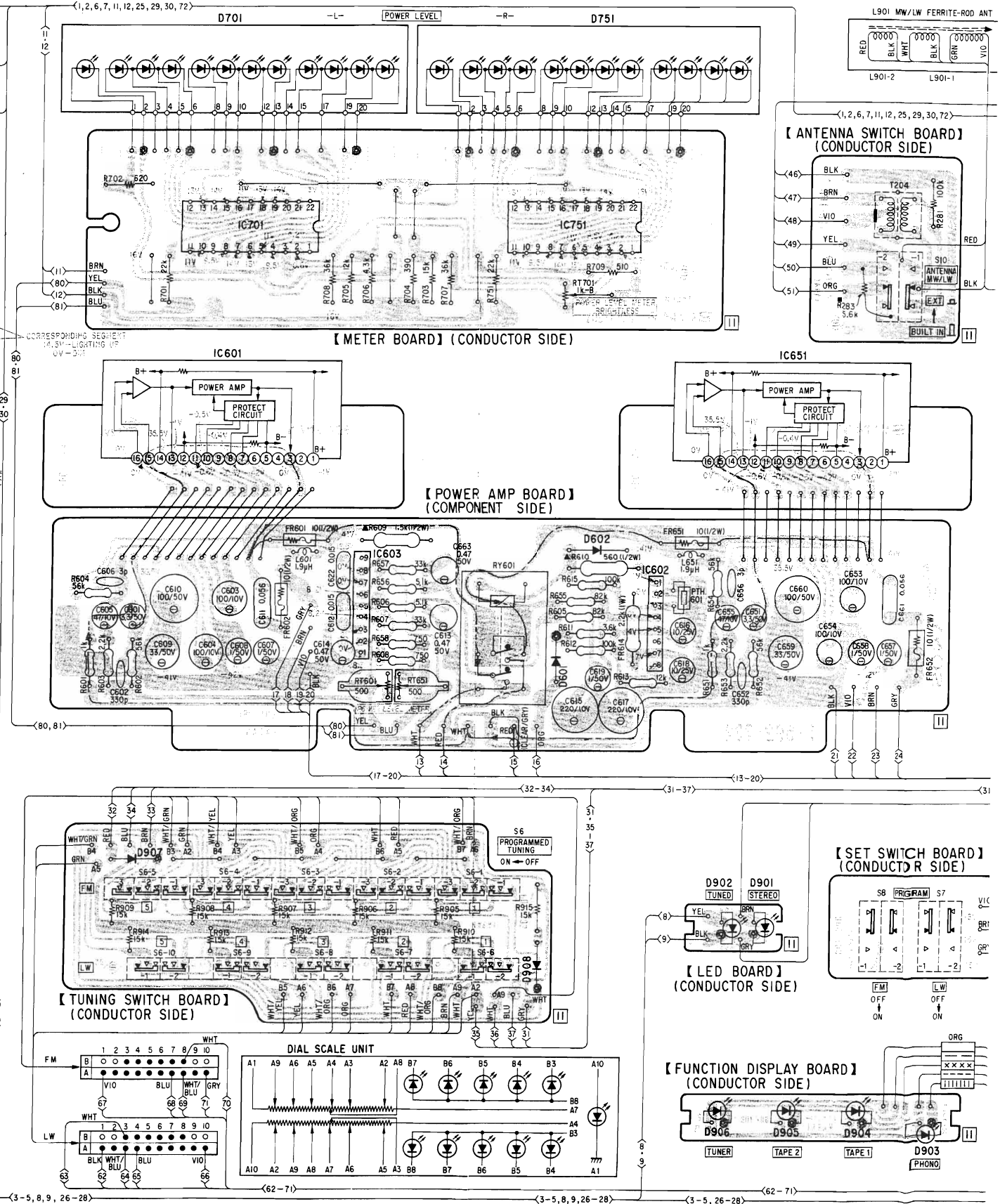
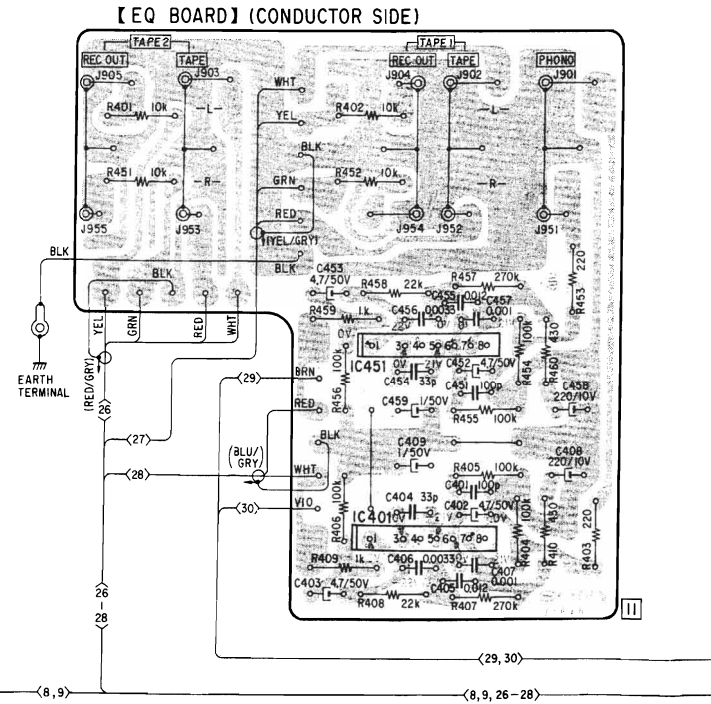
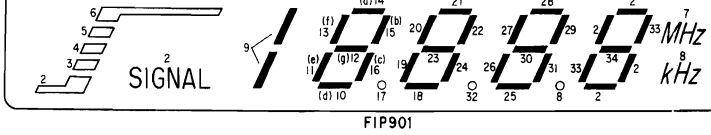
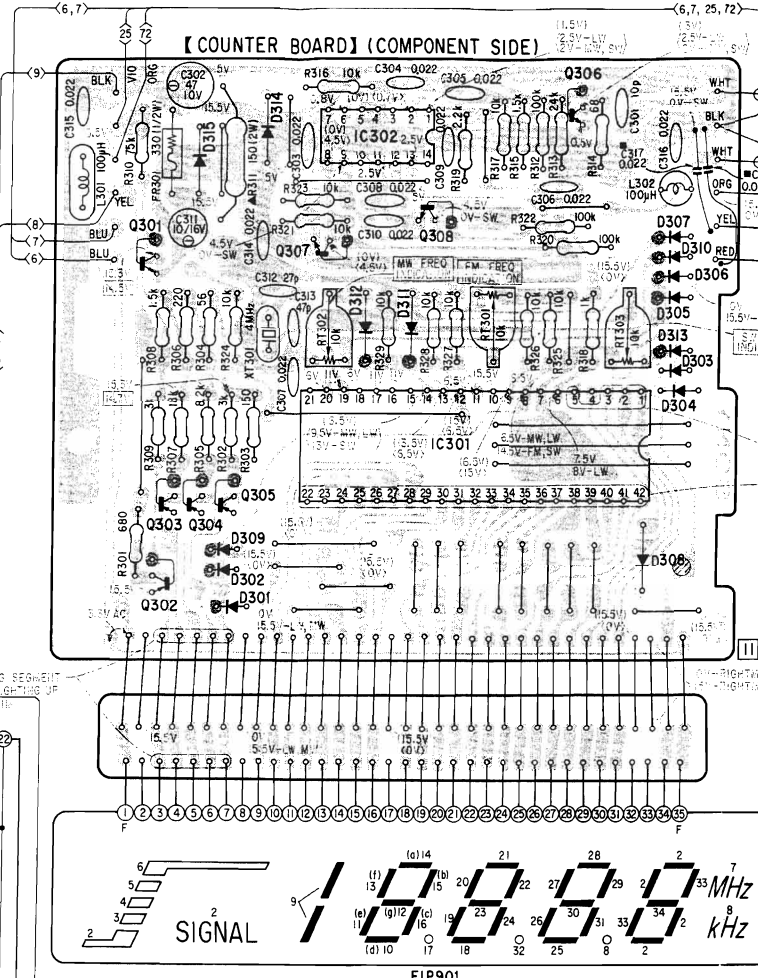
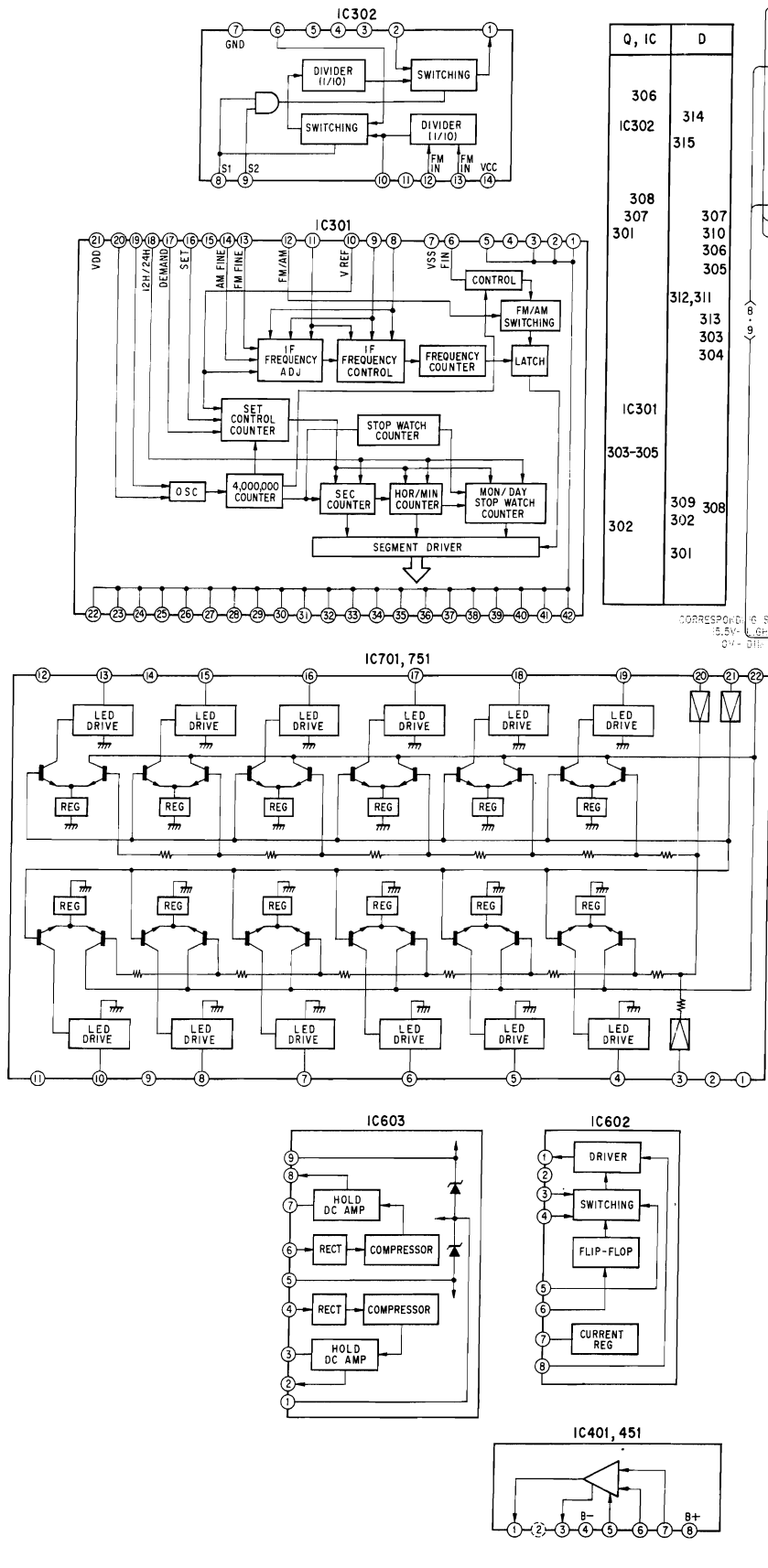



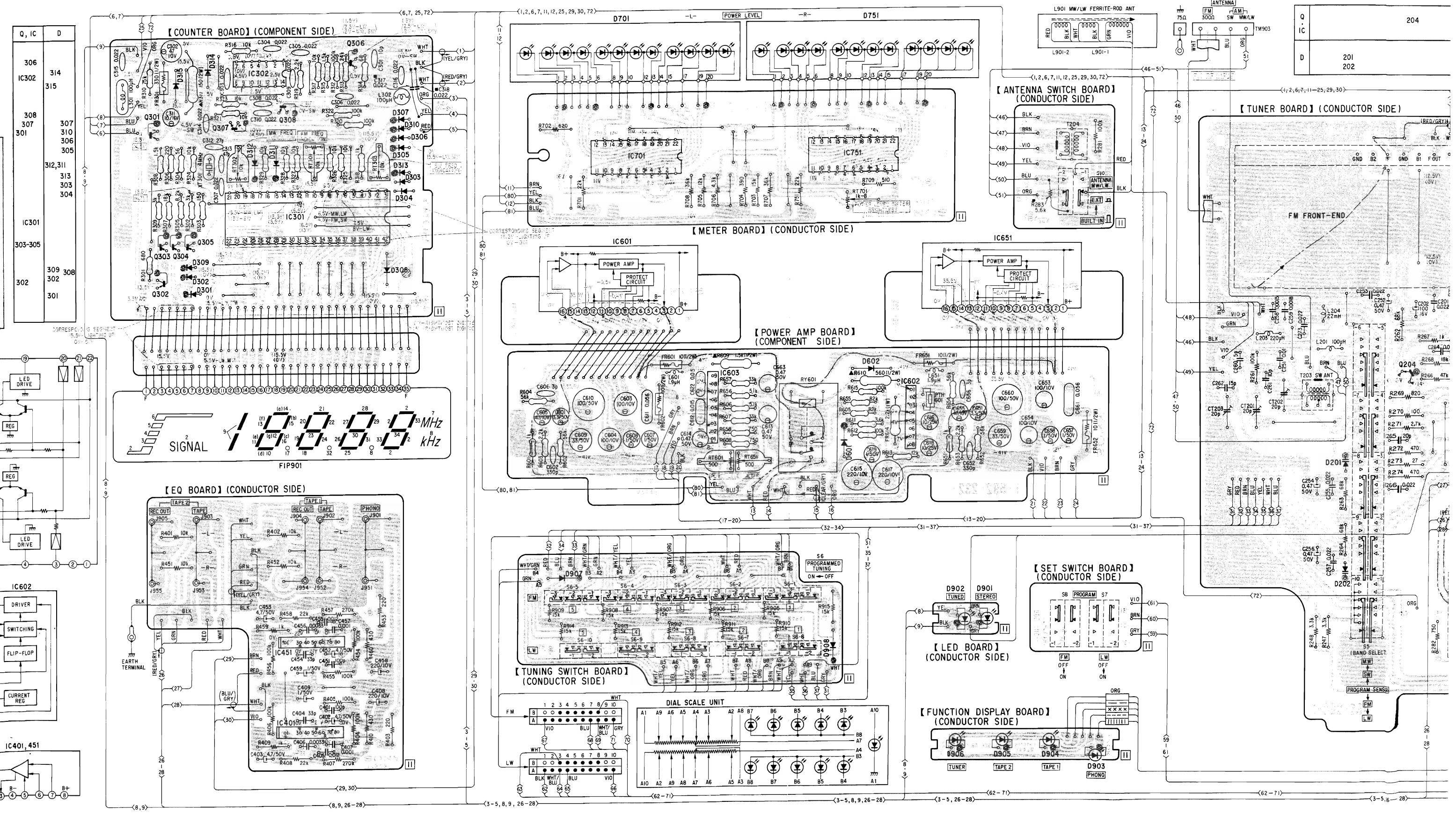

Q	IC	204
D		201 202

# STR-434L STR-434L

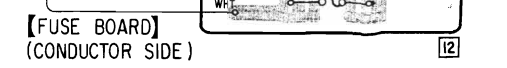
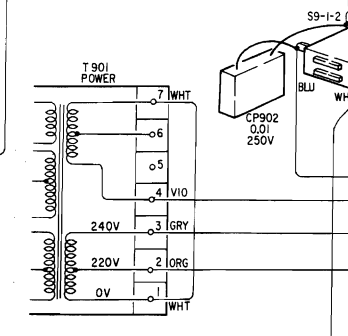
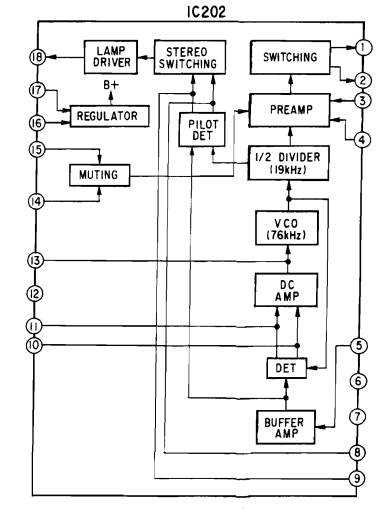
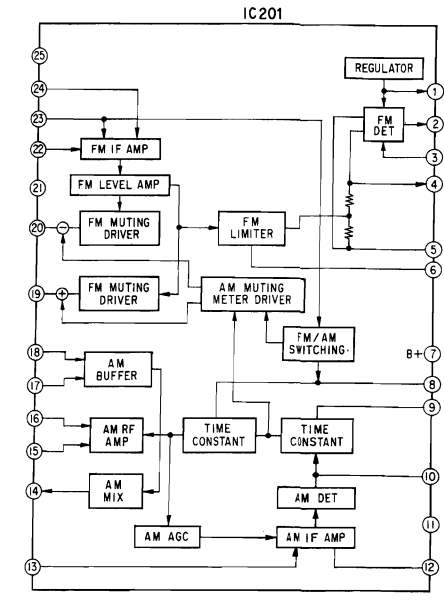
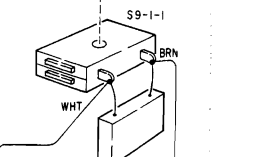
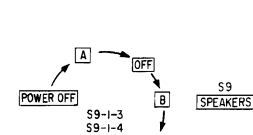
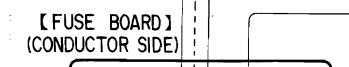
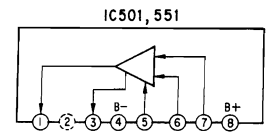
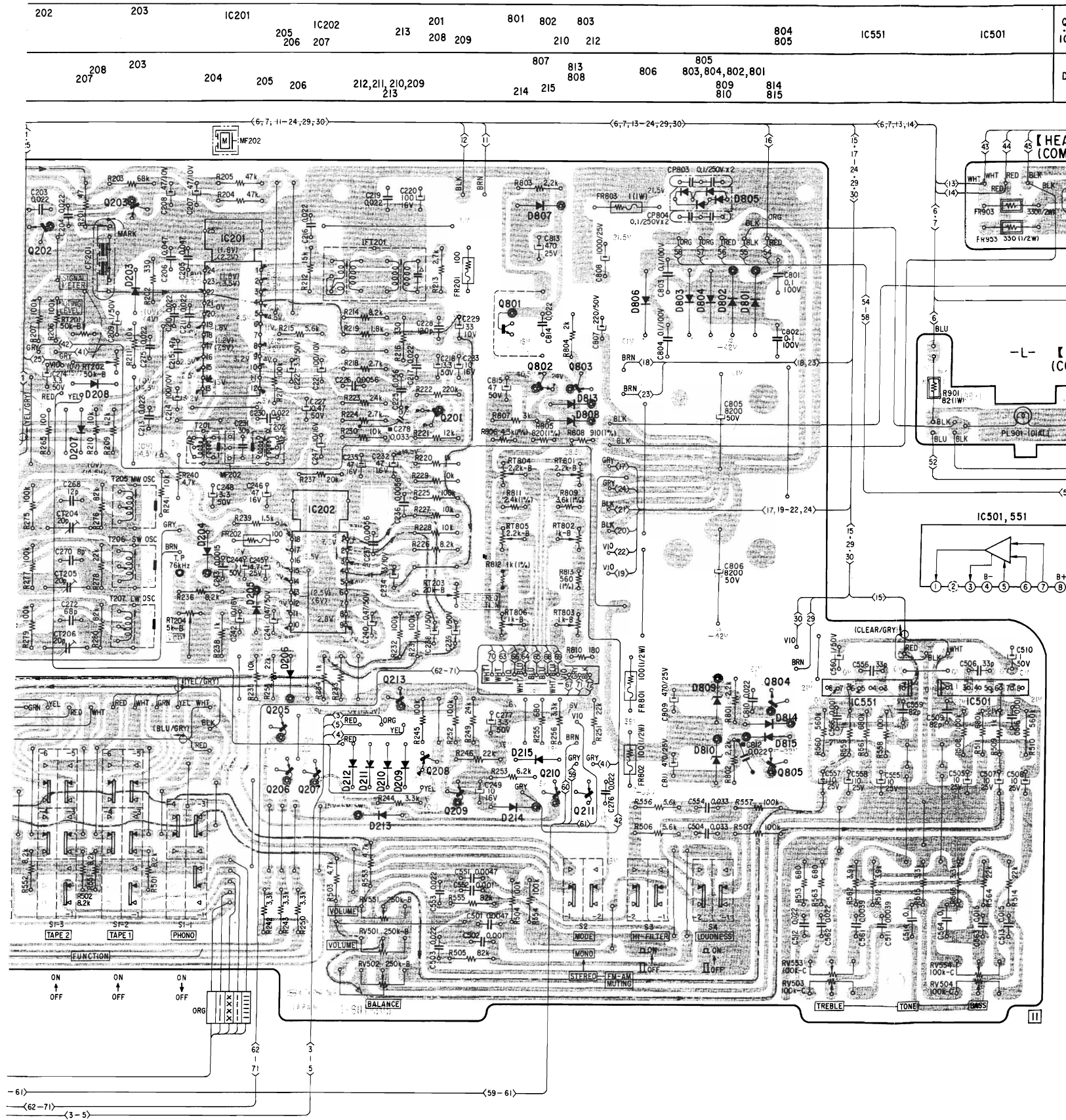

# STR-434L STR-434L

## 4-3. SCHEMATIC DIAGRAM

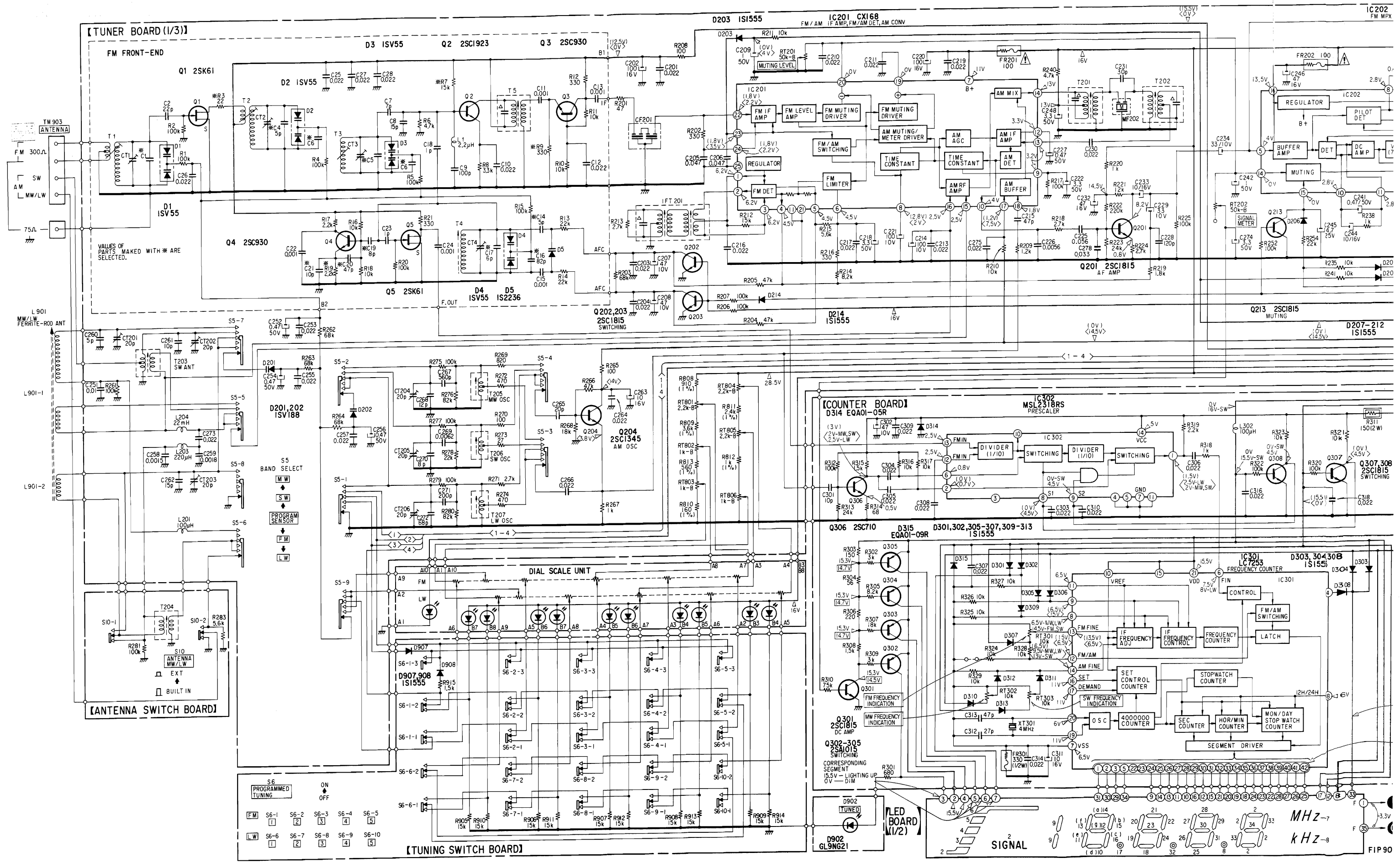

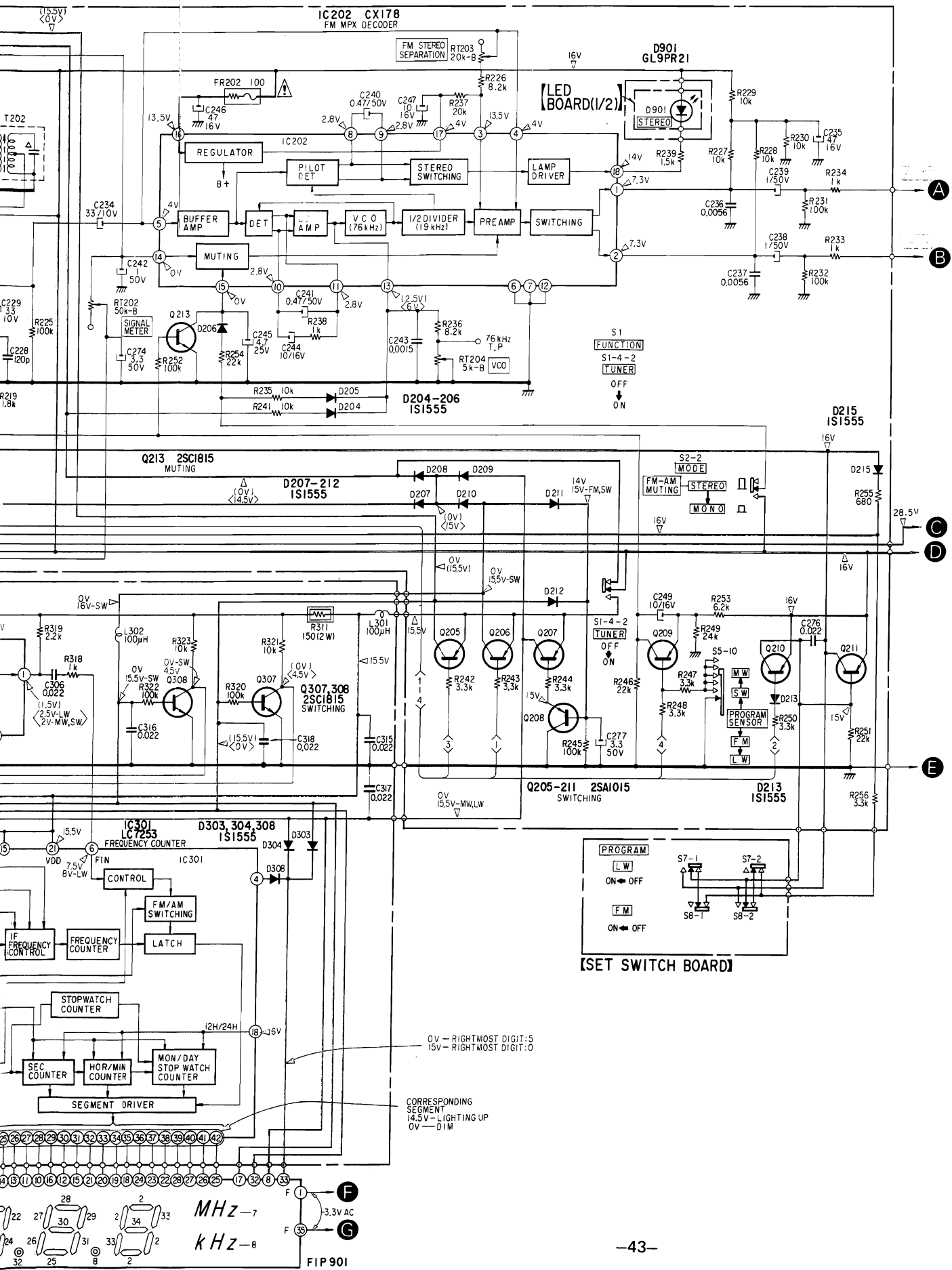

(FOR MOUNTING DIAGRAM)

Note:  
 • Color code of sleeving over the end of the jacket.

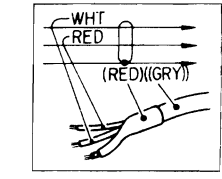

- : parts extracted from the component side.
- : parts extracted from the conductor side.
- : indicates side identified with part number.
- : part mounted on the conductor side.

- ▲ : nonflammable resistor.
- : B+ pattern
- : Signal Path
- : R-CH signal path
- : L-CH signal path

Note: The components identified by shading and mark are critical for safety. Replace only with part number specified.

(FOR SCHEMATIC DIAGRAM)

- Note:
- All capacitors are in  $\mu F$  unless otherwise noted.  $pF : \mu\mu F$
  - 50WV or less are not indicated except for electrolytics and tantalum.
  - All resistors are in ohms,  $\frac{1}{4}W$  unless otherwise noted.  $k\Omega : 1000\Omega, M\Omega : 1000k\Omega$
  - : nonflammable resistor.
  - : fusible resistor.
  - △ : internal component.
  - : panel designation.
  - : adjustment for repair.
  - : B+ bus.
  - : B- bus.
  - Voltages are dc with respect to ground unless otherwise noted.
  - Readings are taken under detuned conditions with a VOM (20k $\Omega/V$ ).
  - : FM
  - : SET IS TUNED.
  - < > : AM
  - Voltage variations may be noted due to normal production tolerances.
  - Switch

Ref. No.	Switch	Position
S1	FUNCTION	
S1-1	PHONO	ON
S1-2	TAPE 1	OFF
S1-3	TAPE 2	OFF
S1-4	TUNER	OFF
S2	MODE	STEREO, FM -AM MUTING
S3	HI FILTER	OFF
S4	LOUDNESS	OFF
S5	Band Select	PROGRAM SENSOR
S6	PROGRAMMED TUNING	FM 1
S7	PROGRAM (LW)	OFF
S8	PROGRAM (FM)	OFF
S9	SPEAKERS (POWER)	POWER OFF
S10	ANTENNA	BUILT IN

STR-434L STR-434L

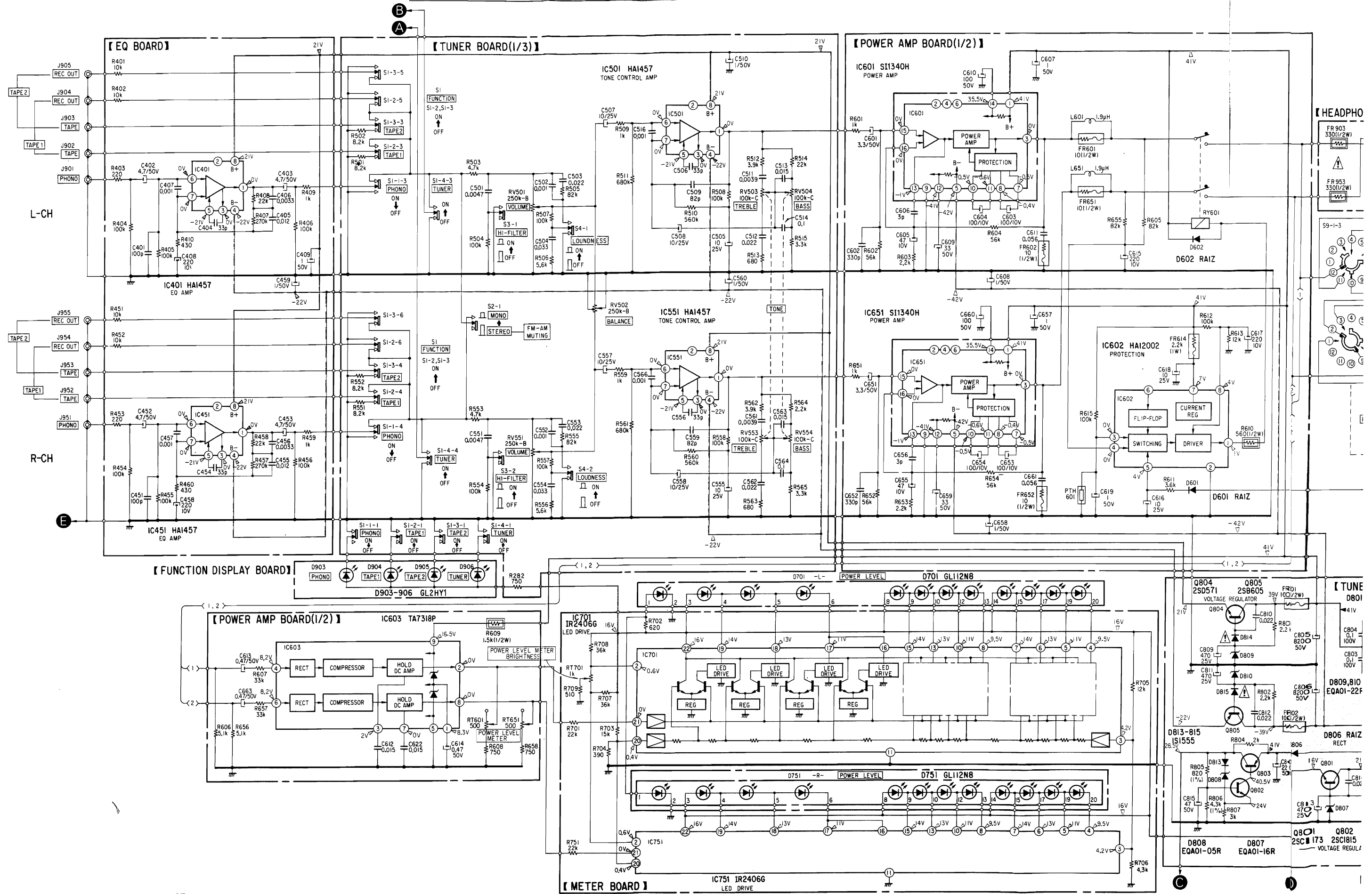

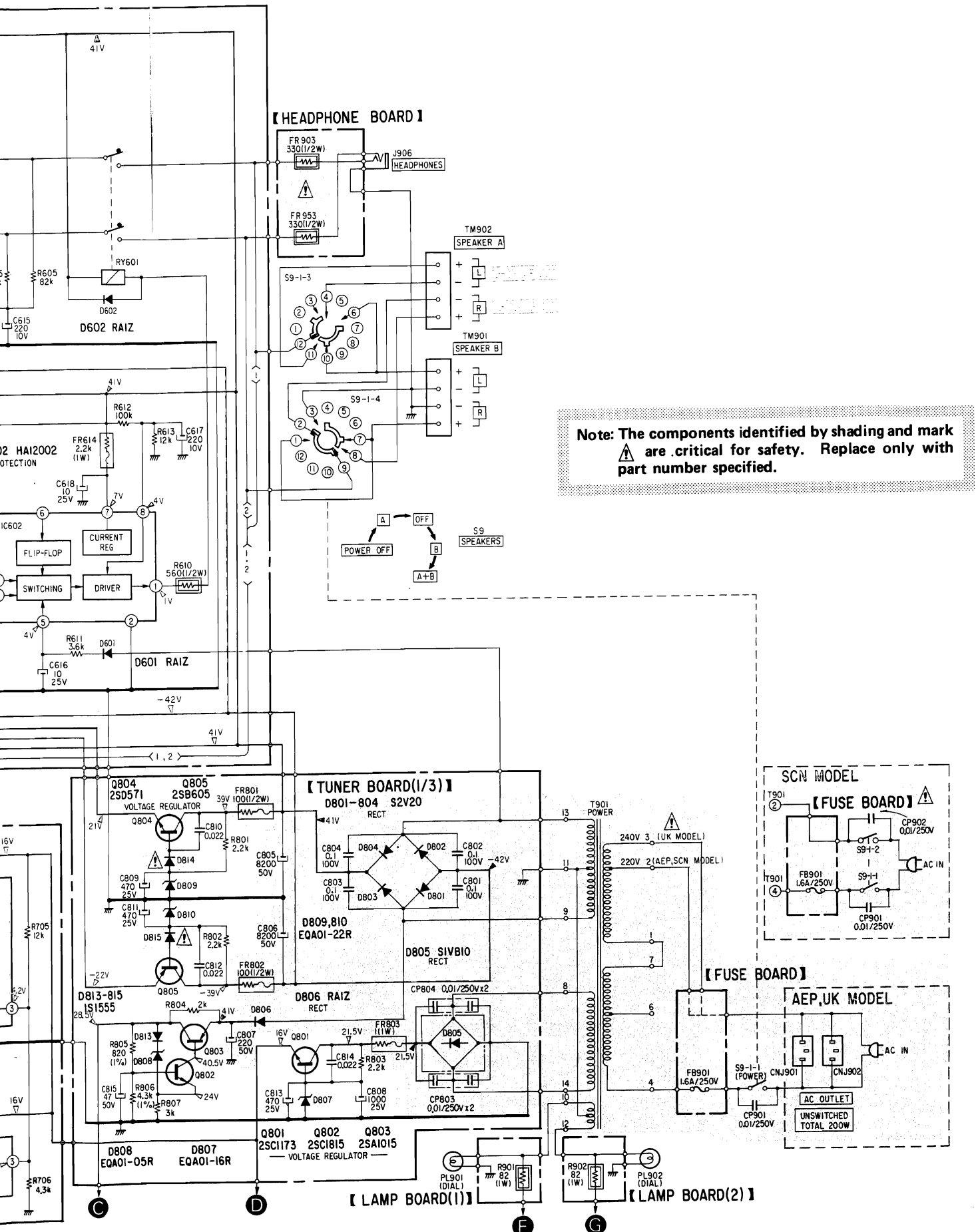

Note: The components identified by shading and mark are critical for safety. Replace only with part number specified.

**Note:**

- All capacitors are in  $\mu\text{F}$  unless otherwise noted.  $\text{pF} : \mu\mu\text{F}$  50VV or less are not indicated except for electrolytics and tantalum.
- All resistors are in ohms,  $\frac{1}{4}\text{W}$  unless otherwise noted.  $\text{k}\Omega : 1000\Omega$ ,  $\text{M}\Omega : 1000\text{k}\Omega$
- : nonflammable resistor.
- : fusible resistor.
- : internal component.
- : panel designation.
- : adjustment for repair.
- : B+ bus.
- : B- bus.
- Voltages are dc with respect to ground unless otherwise noted.
- Readings are taken under detuned conditions with a VOM ( $20\text{k}\Omega/\text{V}$ ).  
 ( ) : FM  
 □ : SET IS TUNED.  
 < > : AM
- Voltage variations may be noted due to normal production tolerances.
- Switch

Ref. No.	Switch	Position
S1	FUNCTION	
S1-1	PHONO	ON
S1-2	TAPE 1	OFF
S1-3	TAPE 2	OFF
S1-4	TUNER	OFF
S2	MODE	STEREO, FM -AM MUTING
S3	HI FILTER	OFF
S4	LOUDNESS	OFF
S5	Band Select	PROGRAM SENSOR
S6	PROGRAMMED TUNING	FM 1
S7	PROGRAM (LW)	OFF
S8	PROGRAM (FM)	OFF
S9	SPEAKERS (POWER)	POWER OFF
S10	ANTENNA	BUILT IN

# SECTION 5 EXPLODED VIEWS

**STR-434L**

**A**

**B**

**C**

**D**

(1)

**Note:**

- Items with no part number and/or no description are not stocked because they are seldom required for routine service.
- All screws are Phillips (cross recess) type unless otherwise noted.
- (-) = slotted head
- Circled letters (A) to (Z) are applicable to European models only.

4-864-457-00 (L)  
Case

4-864-419-12 (B)  
Adiabatic Sheet

X-4864-302-0 (A)  
Foot Stopper Ass'y

4-847-802-11 (A)  
Screw, case

4-861-045-00  
Label, caution

4-847-802-11 (A)  
Screw, case

X-4864-406-2 (N)  
Front Panel Ass'y; including parts  
marked ▲ 1, 2

Label, MADE IN JAPAN  
(UK model)

▲ 1  
4-864-330-00 (B)  
Holder (L), panel

3-831-441-XX (B)  
Felt

2

BVTT  
3x6

BVTT  
3x6

3

X-4864-401-1 (C)  
Knob Ass'y; SPEAKERS,  
TONE

X-4864-403-0 (D)  
Knob Ass'y, VOL

X-4864-401-2 (C)  
Knob Ass'y, BAND SELECT

X-4864-402-0 (D)  
Knob Ass'y, TUNING

Printed Circuit Board,  
function display

4-864-435-00 (B)  
Spring

4-864-422-00 (B)  
Knob, PROGRAMMED  
TUNING

4-864-331-00 (B)  
Holder (R), panel

Holder  
Heat Sink  
BVTT3x6

X-4864-303-0 (A)  
Foot Ass'y

4

1-226-231-00 (D)  
Resistor, variable 100k $\Omega$ /100k $\Omega$ -C; BASS,  
TREBLE (RV503, 504, RV553, 554)

4-864-307-00 (A)  
Ring, flexible

Bracket, switch

Supplied with variable resistor

4-864-328-00 (B)  
Knob; FUNCTION, LOUDNESS,  
HI-FILTER, MODE

Supplied with variable resistor

BVTT3x6

Supplied with switch

5

1-226-339-00 (C)  
Resistor, variable 250k/250k/250k $\Omega$ ;  
VOL, BAL (RV501, 502, 551)

1-553-062-00 (D)  
Switch, pushbutton; MODE/  
HI-FILTER/LOUDNESS (S2, 3, 4)

3-701-589-00 (A)  
P3x8

1-463-289-00 (M)  
Front End

Complete Circuit Board, tuner

1-553-066-00 (F)  
Switch, rotary-slide; BAND SELECT (S5)

1-553-063-00 (G)  
Switch, pushbutton; FUNCTION (S1)

Supplied with switch

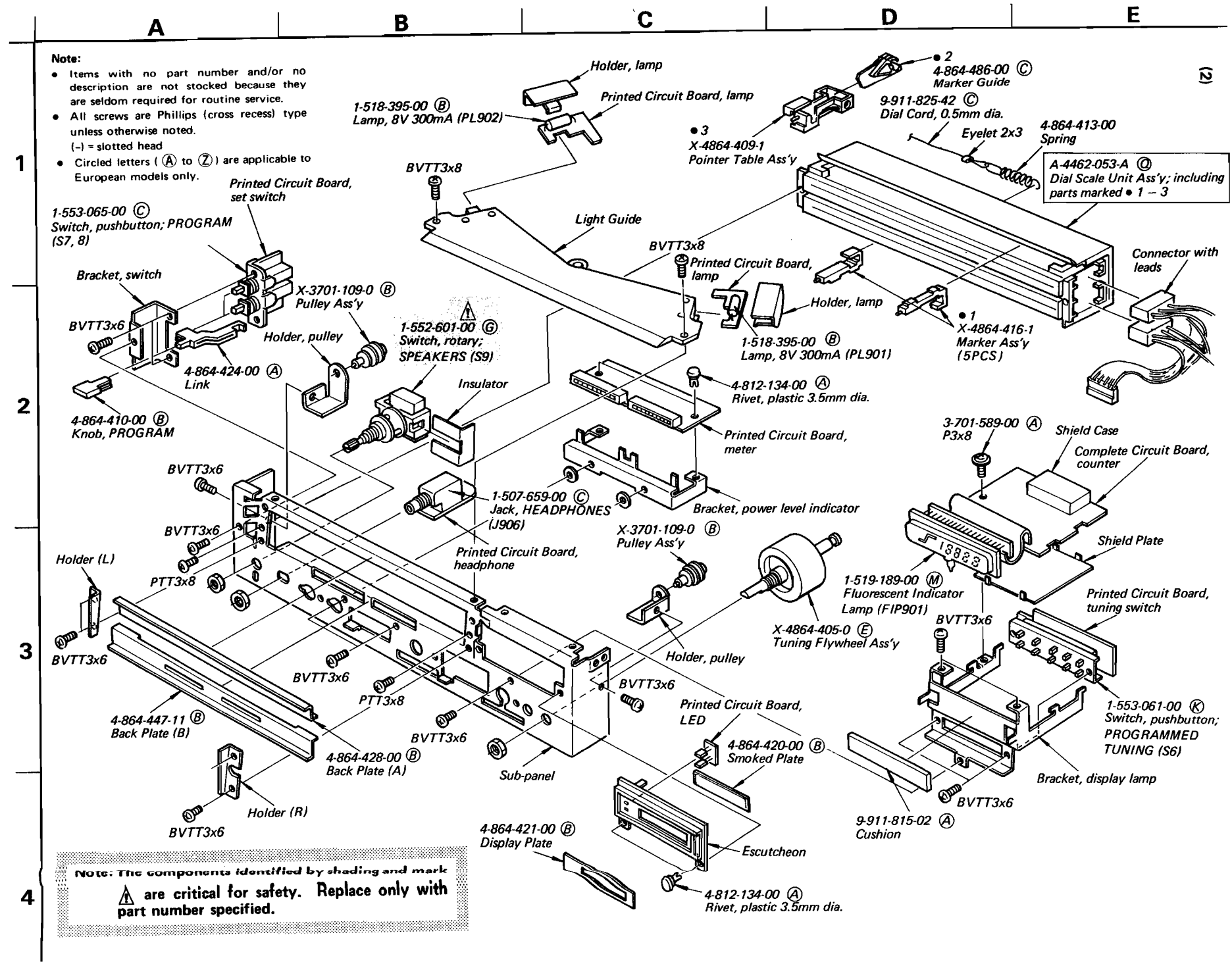

**Note:**

- Items with no part number and/or no description are not stocked because they are seldom required for routine service.
- All screws are Phillips (cross recess) type unless otherwise noted.
- (-) = slotted head
- Circled letters (A) to (Z) are applicable to European models only.

1-553-065-00 (C)  
Switch, pushbutton; PROGRAM (S7, B)

4-864-410-00 (B)  
Knob, PROGRAM

4-864-447-11 (B)  
Back Plate (B)

4-864-428-00 (B)  
Back Plate (A)

**Note:** The components identified by shading and mark **▲** are critical for safety. Replace only with part number specified.

1-518-395-00 (B)  
Lamp, 8V 300mA (PL902)

1-552-601-00 (G)  
Switch, rotary; SPEAKERS (S9)

1-507-659-00 (C)  
Jack, HEADPHONES (J906)

4-864-421-00 (B)  
Display Plate

• 3  
X-4864-409-1  
Pointer Table Ass'y

Printed Circuit Board, lamp

1-518-395-00 (B)  
Lamp, 8V 300mA (PL901)

X-3701-109-0 (B)  
Pulley Ass'y

Printed Circuit Board, LED

4-812-134-00 (A)  
Rivet, plastic 3.5mm dia.

• 2  
4-864-486-00 (C)  
Marker Guide

9-911-825-42 (C)  
Dial Cord, 0.5mm dia.

4-864-413-00  
Spring

A-4462-053-A (C)  
Dial Scale Unit Ass'y; including parts marked • 1 - 3

3-701-589-00 (A)  
P3x8

1-519-189-00 (M)  
Fluorescent Indicator Lamp (FIP901)

X-4864-405-0 (E)  
Tuning Flywheel Ass'y

1-553-061-00 (K)  
Switch, pushbutton; PROGRAMMED TUNING (S6)

9-911-815-02 (A)  
Cushion

(2)



SECTION 6  
ELECTRICAL PARTS LIST

Note: Circled letters (A) to (Z) are applicable to European models only.

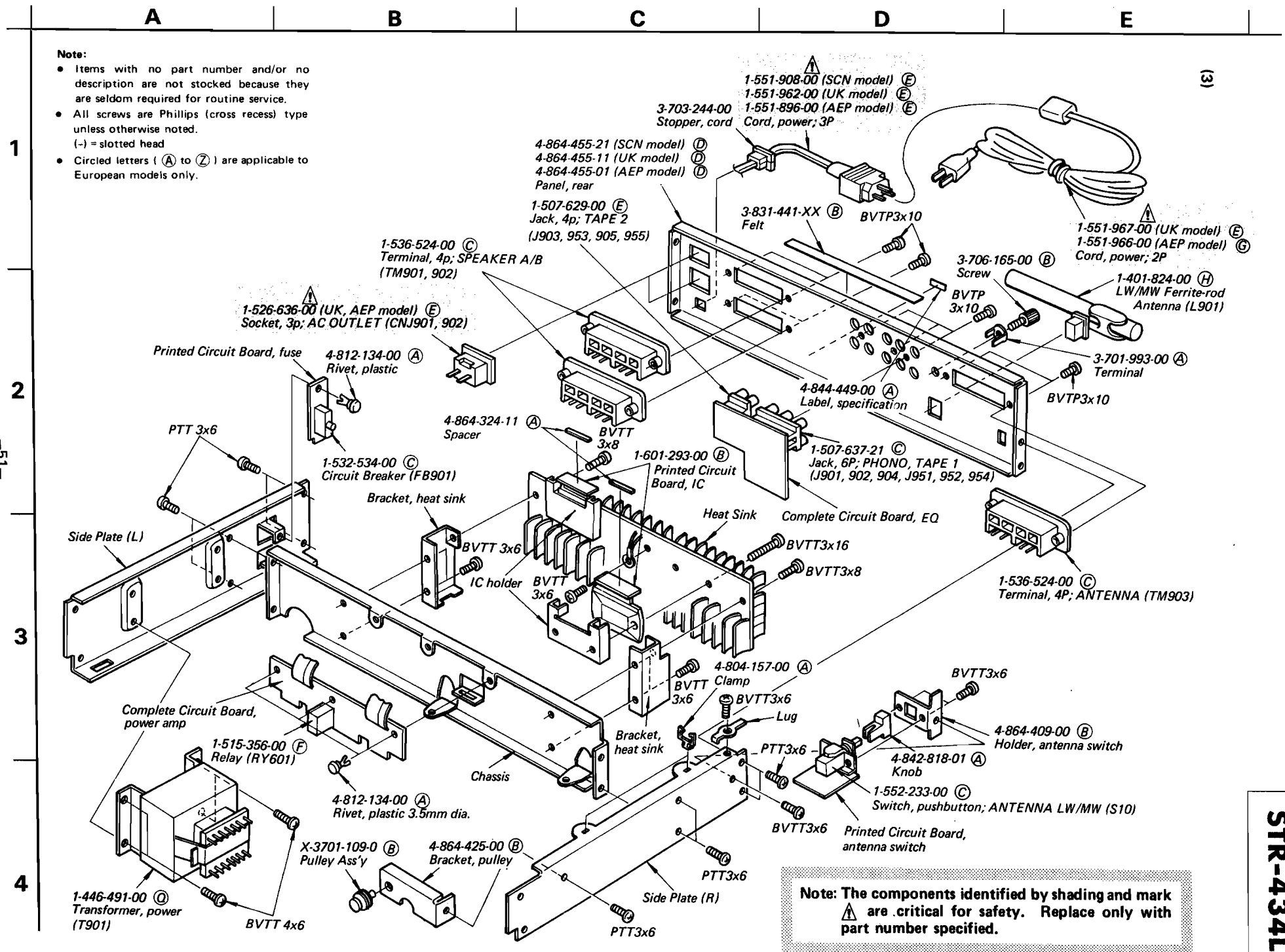

Ref. No.	Part No.	Description
<b>SEMICONDUCTORS</b>		
<b>Transistors</b>		
Q201-203	8-729-663-47 (B)	2SC1364
Q204	8-729-334-58 (B)	2SC1345
Q205-211	8-729-201-52 (B)	2SA1015
Q213	8-729-663-47 (B)	2SC1364
Q301	8-729-663-47 (B)	2SC1364
Q302-305	8-729-201-52 (B)	2SA1015
Q306	8-729-671-15 (B)	2SC710-15
Q307, 308	8-729-663-47 (B)	2SC1364
Q801	8-729-217-33 (C)	2SC1173
Q802	8-729-663-47 (B)	2SC1364
Q803	8-729-201-52 (B)	2SA1015
Q804	8-760-413-10 (B)	2SC1475
Q805	8-729-160-51 (B)	2SB605
<b>ICs</b>		
IC201	8-751-680-01 (J)	CX168
IC202	8-751-780-00 (H)	CX178
IC301	8-759-872-53 (M)	LC7253
IC302	8-759-923-18 (J)	MSL2318RS
IC401, 451	8-759-314-57 (C)	HA1457
IC501, 551	8-759-314-57 (C)	HA1457
IC601, 651	8-759-313-40 (M)	SI1340H
IC602	8-759-320-02 (E)	HA12002
IC603	8-759-273-18 (D)	TA7318P
IC701, 751	8-759-924-07 (H)	IR2406G
<b>Diodes</b>		
D201, 202	8-719-100-81 (D)	1SV118
D203-215	8-719-815-55 (B)	1S1555
D301-313	8-719-815-55 (B)	1S1555
D314	8-719-931-05 (B)	EQB01-05
D315	8-719-931-09 (B)	EQB01-09
<b>TRANSFORMERS</b>		
T201	1-409-323-00 (B)	Filter
T202	1-409-324-00 (B)	Filter
T203	1-401-822-00 (B)	SW ANT
T204	1-401-819-00 (B)	Antenna
T205	1-405-881-00 (B)	MW Osc
T206	1-405-885-00 (B)	SW Osc
T207	1-405-882-00 (B)	LW Osc
T901	$\Delta$ 1-446-491-00 (C)	Transformer, power
IFT201	1-404-167-00 (D)	FM Discriminator
<b>COILS</b>		
L204	1-407-210-XX (B)	22mH, microinductor
L301	1-407-750-00 (B)	100 $\mu$ H, microinductor
L302	1-407-169-XX (B)	100 $\mu$ H, microinductor
L901	1-401-824-00 (H)	LW/MW Ferrite-rod Antenna
<b>TRANSFORMERS</b>		
D809, 810	8-719-931-22 (B)	EQB01-22
D813	8-719-815-55 (B)	1S1555
D814, 815	$\Delta$ 8-719-815-55 (B)	1S1555
D901	8-719-909-21 (B)	GL9PR21
D902	8-719-909-22 (B)	GL9NG21
D903-906	8-719-900-21 (B)	GL2HY1
D907, 908	8-719-815-55 (B)	1S1555
<b>TRANSFORMERS</b>		
D601, 602	8-719-200-02 (E)	10E2
D701, 751	8-719-911-28 (H)	GL112N8
D801-804	$\Delta$ 8-719-911-55 (C)	U05G
D805	$\Delta$ 8-719-511-20 (C)	SIYB20
D806	$\Delta$ 8-719-200-02 (E)	10E2
D807	8-719-931-16 (B)	EQB01-16
D808	8-719-931-05 (B)	EQB01-05

**Note: The components identified by shading and mark  $\Delta$  are critical for safety. Replace only with part number specified.**

$\Rightarrow$ : Due to standardization, interchangeable replacements may be substituted for parts specified in the diagrams.

Note: Circled letters (A to Z) are applicable to European models only.

Note: Circled letters (A to Z) are applicable to European models only.

Ref. No. Part No. Description

**CAPACITORS**

All capacitors are in  $\mu$ F and ceramic unless otherwise noted. 50WV or less are not indicated except for electrolytics. Common capacitors are omitted. Refer to the lists on pages 55 and 56 for their part numbers.

C243	1-104-081-00	(B) 0.0015	polystyrol
C267	1-103-719-00	(B) 560p	polystyrol
C269	1-103-744-00	(B) 0.0062	polystyrol
C271	1-103-708-00	(B) 200p	polystyrol
C801-804	(A)1-108-389-00	(B) 0.1 100V	mylar
C805, 806	(A)1-125-204-00	(B) 8200 50V	elect
C807	(A)1-123-361-00	(B) 220 50V	elect
CT201-206	1-141-171-XX	(B) Trimmer	

**RESISTORS**

All resistors are in ohms. Common  $\frac{1}{4}$ W carbon resistors are omitted. Refer to the list on page 55 for their part numbers.

R311	1-206-644-00	(B) 150	2W	metal oxide (nonflammable)
R609	1-247-244-00	(A) 1.5k	$\frac{1}{2}$ W	(nonflammable)
R610	1-247-234-00	(A) 560	$\frac{1}{2}$ W	(nonflammable)
R805	1-214-130-00	(A) 820	$\frac{1}{4}$ W	metal oxide
R806	1-214-147-00	(A) 4.3k	$\frac{1}{4}$ W	metal oxide
R808	1-214-131-00	(A) 910	$\frac{1}{4}$ W	metal oxide
R809	1-214-145-00	(A) 3.6k	$\frac{1}{4}$ W	metal oxide
R810	1-214-113-00	(A) 160	$\frac{1}{4}$ W	metal oxide
R811	1-214-141-00	(A) 2.4k	$\frac{1}{4}$ W	metal oxide
R812	1-214-132-00	(A) 1k	$\frac{1}{4}$ W	metal oxide
R813	1-214-126-00	(A) 560	$\frac{1}{4}$ W	metal oxide
R901, 902	1-213-130-00	(A) 82	1W	metal oxide (nonflammable)
R905-914	1-246-797-00	(A) 15k	1/8W	carbon
RT201,202	1-226-238-00	(B) 50k, adjustable; MUTING LEVEL/SIGNAL METER CALIBRATION		
RT203	1-226-237-00	(B) 20k, adjustable; FM STEREO SEPARATION		

Note: The components identified by shading and mark **(A)** are critical for safety. Replace only with part number specified.

Ref. No. Part No. Description

RT204	1-226-235-00	(B) 5k, adjustable; VCO
RT301-303	1-226-236-00	(B) 10k, adjustable; FM/MW/SW FREQUENCY INDICATION
RT601, 651	1-226-232-00	(B) 500, adjustable; POWER LEVEL METER CALIBRATION
RT701	1-226-233-00	(B) 1k, adjustable; POWER LEVEL METER BRIGHTNESS
RT801	1-224-250-XX	(B) 2.2k, adjustable
RT802, 803	1-224-249-XX	(B) 1k, adjustable
RT804, 805	1-224-250-XX	(B) 2.2k, adjustable
RT806	1-224-249-XX	(B) 1k, adjustable
RV501,502	1-226-339-00	(G) 250k/250k/250k-B, variable; VOL/BAL
RV551		
RV503,504	1-226-231-00	(D) 100k/100k, variable; BASS/TREBLE
RV553,554		
FR201, 202	(A)1-212-881-00	(B) 100 $\frac{1}{4}$ W fusible
FR301	1-212-994-00	(A) 330 $\frac{1}{2}$ W fusible
FR601, 602	1-212-958-00	(B) 10 $\frac{1}{2}$ W fusible
FR651, 652		
FR614	1-213-147-00	(A) 2.2k 1W fusible
FR801, 802	(A)1-212-982-00	(B) 100 $\frac{1}{2}$ W fusible
FR803	(A)1-213-036-00	(B) 1 1W fusible
FR903, 953	(A)1-247-228-00	(A) 330 $\frac{1}{2}$ W (nonflammable)

**SWITCHES**

S1	1-553-063-00	(G) Pushbutton, FUNCTION
S2, 3, 4	1-553-062-00	(D) Pushbutton, MODE/HI-FILTER/LOUDNESS
S5	1-553-066-00	(F) Rotary-slide, BAND SELECT
S6	1-553-061-00	(K) Pushbutton, PROGRAMMED TUNING
S7, 8	1-553-065-00	(C) Pushbutton, PROGRAM
S9	(A)1-552-601-00	(G) Rotary, SPEAKERS
S10	1-552-233-00	(C) Pushbutton, ANTENNA

**MISCELLANEOUS**

CF201	1-527-534-93	(D) Filter
CNJ901,902	(A)1-526-636-00	(E) AC Outlet (AEP, UK model)
CP803,804	(A)1-102-394-00	(B) 0.01 + 0.01 $\mu$ F 250V ceramic
CP901	(A)1-130-196-00	(D) 0.01 $\mu$ F
CP902	(A)1-130-196-00	(D) 0.01 $\mu$ F (SCN model)

Ref. No. Part No. Description

FB901	(A)1-532-534-00	(C) Circuit Breaker
FE	1-463-289-00	(M) Front End
FIP901	1-519-189-00	(M) Fluorescent Indicator Lamp
J901, 951	1-507-637-21	(C) Jack, 6P; PHONO TAPE 1
J902, 952		
J904, 954		
J903, 953	1-507-629-00	(E) Jack, 4P; TAPE 2
J905, 955		
J906	1-507-659-00	(C) Jack, HEADPHONES
MF202	1-527-403-00	(C) Mechanical Filter
PL901, 902	1-518-395-00	(B) Lamp, 8V 300mA
PTH601	1-800-427-00	(B) Thermistor, positive
RY601	1-515-356-00	(F) Relay
TM901-903	1-536-524-00	(C) Terminal, 4P; SPEAKER A/B, ANTENNA
XT301	1-527-533-00	(D) Crystal
	(A)1-551-896-00	(E) Cord, power; 3P (AEP model)
	(A)1-551-908-00	(E) Cord, power; 3P (SCN model)
	(A)1-551-962-00	(E) Cord, power; 3P (UK model)
	(A)1-551-966-00	(G) Cord, power; 2P (AEP model)
	(A)1-551-967-00	(E) Cord, power; 2P (UK model)
	1-601-293-00	(B) Printed Circuit Board, IC

Note: The components identified by shading and mark **(A)** are critical for safety. Replace only with part number specified.

**ACCESSORIES AND PACKING MATERIALS**

<u>Part No.</u>	<u>Description</u>
1-501-184-00	(C) Feeder Antenna
1-501-193-00	(B) Antenna
3-701-630-00	(A) Bag, plastic
3-770-953-11	(F) Manual, instruction
4-809-251-00	(A) Bag, plastic
4-864-402-00	(B) Cushion, lower
4-864-403-00	(B) Cushion, upper left
4-864-404-00	(B) Cushion, upper right
4-864-463-00	(E) Carton

**ELECTROLYTIC CAPACITORS**

Note: Circled letter (A to Z) are applicable to European models only.

CAP. (μF)	RATING → : Use the high voltage rated one.					
	6.3 VOLT.	10 VOLT.	16 VOLT.	25 VOLT.	35 VOLT.	50 VOLT.
	PART No.	PART No.	PART No.	PART No.	PART No.	PART No.
0.47						1-121-726-00 (A)
1.0					→	1-121-391-00 (A)
2.2					→	1-121-450-00 (A)
3.3	→	→	→	1-121-392-00 (A)	→	1-121-393-00 (A)
4.7	→	→	→	1-121-395-00 (A)	→	1-121-396-00 (A)
10	→	→	1-121-651-00 (A)	1-121-398-00 (A)	→	1-121-738-00 (A)
22	→	→	1-121-479-00 (A)	1-121-480-00 (A)	1-121-662-00 (A)	1-121-152-00 (A)
33	→	→	1-121-403-00 (A)	1-121-404-00 (A)	1-121-652-00 (B)	1-121-405-00 (A)
47	→	1-121-352-00 (A)	1-121-409-00 (A)	1-121-410-00 (A)	1-121-653-00 (B)	1-121-411-00 (A)
100	→	1-121-414-00 (A)	1-121-415-00 (A)	1-121-416-00 (A)	1-121-357-00 (B)	1-121-417-00 (B)
220	1-121-419-00 (B)	1-121-420-00 (B)	1-121-421-00 (A)	1-121-422-00 (B)	1-121-261-00 (C)	1-121-423-00 (B)
330	1-121-751-00 (B)	1-121-805-00 (B)	1-121-521-00 (C)	1-121-654-00 (B)	1-121-655-00 (D)	1-121-656-00 (C)
470	1-121-424-00 (B)	1-121-425-00 (C)	1-121-426-00 (C)	1-121-733-00 (B)	1-121-361-00 (E)	1-121-810-00 (D)
1000	-	1-121-736-00 (C)	1-121-245-00 (D)	1-121-657-00 (D)	1-121-388-00 (E)	1-123-061-00 (F)
2200	1-121-658-00 (B)	1-121-659-00 (C)	1-121-660-00 (D)	1-123-067-00 (F)	1-121-984-00 (F)	-
3300	1-121-661-00 (D)	1-123-075-00 (E)	1-123-071-00 (F)	-	-	-

CAP. (μF)	100 VOLT.	160 VOLT.	250 VOLT.	350 VOLT.
	PART No.	PART No.	PART No.	PART No.
0.47	-	-	-	-
1.0	1-123-249-00 (A)	1-123-252-00 (A)	1-123-003-00 (B)	1-121-168-00 (B)
2.2	1-123-250-00 (A)	1-123-026-00 (B)	-	1-123-028-00 (B)
3.3	1-121-995-00 (A)	-	1-123-004-00 (B)	1-123-006-00 (C)
4.7	1-123-255-00 (A)	1-121-246-00 (B)	1-121-759-00 (B)	1-123-007-00 (D)
10	1-121-126-00 (B)	1-121-999-00 (B)	1-123-254-00 (C)	1-123-008-00 (D)
22	1-121-996-00 (C)	1-123-253-00 (C)	1-123-005-00 (D)	1-123-022-00 (D)
33	1-121-997-00 (C)	1-121-757-00 (C)	-	-
47	1-123-251-00 (C)	1-121-919-00 (C)	-	-
100	1-123-084-00 (E)	-	-	-

**CERAMIC CAPACITORS (A)**

CAP. (pF)	RATING						
	50 VOLT.	CAP. (pF)	50 VOLT.	CAP. (pF)	50 VOLT.	CAP. (μF)	50 VOLT.
	PART No.		PART No.		PART No.		PART No.
0.5	1-101-837-00	22	1-102-959-00	150	1-101-361-00	0.001	1-102-074-00
0.75	1-101-586-00	24	1-102-960-00	160	1-101-367-00	0.0012	1-102-118-00
1.0	1-102-934-00	27	1-102-961-00	180	1-102-976-00	0.0015	1-102-119-00
1.5	1-101-576-00	30	1-102-962-00	200	1-102-977-00	0.0018	1-102-120-00
2.0	1-102-935-00	33	1-102-963-00	220	1-102-978-00	0.0022	1-102-121-00
3	1-102-936-00	36	1-102-964-00	240	1-102-979-00	0.0027	1-102-122-00
4	1-102-937-00	39	1-102-965-00	270	1-102-980-00	0.0033	1-102-123-00
5	1-102-942-00	43	1-102-966-00	300	1-102-981-00	0.0039	1-102-124-00
6	1-102-943-00	47	1-101-880-00	330	1-102-820-00	0.0047	1-102-125-00
7	1-102-944-00	51	1-101-882-00	360	1-102-821-00	0.0056	1-102-126-00
8	1-102-945-00	56	1-101-884-00	390	1-102-822-00	0.0068	1-102-127-00
9	1-102-946-00	62	1-101-886-00	430	1-102-823-00	0.0082	1-102-128-00
10	1-102-947-00	68	1-101-888-00	470	1-102-824-00	0.01	1-102-129-00
11	1-102-948-00	75	1-101-890-00	510	1-101-059-00	0.022	1-101-005-00
12	1-102-949-00	82	1-102-971-00	560	1-102-115-00	0.047	1-101-006-00
13	1-102-950-00	91	1-102-972-00	680	1-102-116-00		
15	1-102-951-00	100	1-102-973-00	820	1-102-117-00		
16	1-102-952-00	110	1-102-815-00				
18	1-102-953-00	120	1-102-816-00				
20	1-102-958-00	130	1-101-081-00				

0.001μF = 1,000pF

**CERAMIC (SEMICONDUCTOR) CAPACITORS (A)**

CAP. (μF)	RATING → : Use the high voltage rated one.				
	25 VOLT.	50 VOLT.	CAP. (μF)	25 VOLT.	50 VOLT.
	PART No.	PART No.		PART No.	PART No.
0.001	→	1-161-039-00	0.018	1-161-016-00	1-161-054-00
0.0012	→	1-161-040-00	0.022	1-161-017-00	1-161-055-00
0.0015		1-161-041-00	0.027	1-161-018-00	1-161-056-00
0.0018		1-161-042-00	0.033	1-161-019-00	1-161-057-00
0.0022		1-161-043-00	0.039	1-161-010-00	1-161-058-00
0.0027	→	1-161-044-00	0.047	1-161-021-00	1-161-059-00
0.0033	→	1-161-045-00	0.056	→	1-161-060-00
0.0039	→	1-161-046-00	0.068	→	1-161-061-00
0.0047	→	1-161-047-00	0.082	1-161-024-00	1-161-062-00
0.0056	→	1-161-048-00	0.1	1-161-025-00	1-161-063-00
0.0068	→	1-161-049-00			
0.0082	1-161-012-00	1-161-050-00			
0.01	1-161-013-00	1-161-051-00			
0.012	→	1-161-052-00			
0.015	1-161-015-00	1-161-053-00			

## MYLAR CAPACITORS (A)

Note: Circled letters (A) to (Z) are applicable to European models only.

CAP. (μF)	RATING																		
	50 VOLT.			100 VOLT.			200 VOLT.			CAP. (μF)	50 VOLT.			100 VOLT.			200 VOLT.		
	PART No.	PART No.	PART No.	PART No.	PART No.	PART No.	PART No.	PART No.	PART No.		PART No.	PART No.	PART No.	PART No.	PART No.	PART No.	PART No.	PART No.	
0.001	1-108-227-00	1-108-365-00	1-108-409-00	0.01	1-108-239-00	1-108-377-00	1-108-421-00	0.1	1-108-251-00	1-108-389-00	1-108-433-00								
0.0012	1-108-351-00	1-108-366-00	1-108-410-00	0.012	1-108-357-00	1-108-378-00	1-108-422-00	0.12	1-108-363-00	1-108-390-00	1-108-434-00								
0.0015	1-108-228-00	1-108-367-00	1-108-411-00	0.015	1-108-240-00	1-108-379-00	1-108-423-00	0.15	1-108-252-00	1-108-391-00	1-108-435-00								
0.0018	1-108-352-00	1-108-368-00	1-108-412-00	0.018	1-108-358-00	1-108-380-00	1-108-424-00	0.18	1-108-364-00	1-108-392-00	1-108-436-00								
0.0022	1-108-230-00	1-108-369-00	1-108-413-00	0.022	1-108-242-00	1-108-381-00	1-108-425-00	0.22	1-108-254-00	1-108-393-00	1-108-437-00								
0.0027	1-108-353-00	1-108-370-00	1-108-414-00	0.027	1-108-359-00	1-108-382-00	1-108-426-00	0.27	1-108-854-00	-	-								
0.0033	1-108-232-00	1-108-371-00	1-108-415-00	0.033	1-108-244-00	1-108-383-00	1-108-427-00	0.33	1-108-855-00	-	-								
0.0039	1-108-354-00	1-108-372-00	1-108-416-00	0.039	1-108-360-00	1-108-384-00	1-108-428-00	0.39	1-108-856-00	-	-								
0.0047	1-108-234-00	1-108-373-00	1-108-417-00	0.047	1-108-246-00	1-108-385-00	1-108-429-00	0.47	1-108-857-00	-	-								
0.0056	1-108-355-00	1-108-374-00	1-108-418-00	0.056	1-108-361-00	1-108-386-00	1-108-430-00	-	-	-	-								
0.0068	1-108-237-00	1-108-375-00	1-108-419-00	0.068	1-108-249-00	1-108-387-00	1-108-431-00	-	-	-	-								
0.0082	1-108-356-00	1-108-376-00	1-108-420-00	0.082	1-108-362-00	1-108-388-00	1-108-432-00	-	-	-	-								

## TANTALUM CAPACITORS



CAP. (μF)	RATING						
	3.15 VOLT.	6.3 VOLT.	10 VOLT.	16 VOLT.	20 VOLT.	25 VOLT.	35 VOLT.
0.01					→	→	1-131-396-00 (B)
0.015						→	1-131-397-00 (B)
0.022						→	1-131-398-00 (B)
0.033						→	1-131-399-00 (B)
0.047						→	1-131-400-00 (B)
0.068					→	→	1-131-401-00 (B)
0.1					→	→	1-131-402-00 (B)
0.15					→	→	1-131-403-00 (B)
0.22					→	→	1-131-404-00 (B)
0.33					→	→	1-131-405-00 (B)
0.47	-	-	-	-	1-131-412-00 (B)	→	1-131-406-00 (B)
0.68	-	-	-	1-131-415-00 (B)	→	1-131-410-00 (B)	1-131-407-00 (B)
1.0	-	-	1-131-418-00 (B)	-	1-131-413-00 (B)	→	1-131-408-00 (B)
1.5	-	1-131-421-00 (B)	-	1-131-416-00 (B)	→	1-131-411-00 (B)	1-131-348-00 (B)
2.2	1-131-424-00 (B)	-	1-131-419-00 (B)	-	1-131-414-00 (B)	1-131-355-00 (B)	1-131-349-00 (B)
3.3	-	1-131-422-00 (B)	-	1-131-417-00 (B)	1-131-362-00 (B)	1-131-356-00 (B)	1-131-350-00 (B)
4.7	1-131-425-00 (B)	-	1-131-420-00 (B)	1-131-369-00 (B)	1-131-363-00 (B)	1-131-357-00 (B)	1-131-351-00 (C)
6.8	-	1-131-423-00 (B)	1-131-376-00 (B)	1-131-370-00 (B)	1-131-364-00 (B)	1-131-358-00 (C)	1-131-352-00 (C)
10	1-131-426-00 (B)	1-131-383-00 (B)	1-131-377-00 (B)	1-131-371-00 (B)	1-131-365-00 (C)	1-131-359-00 (C)	1-131-353-00 (D)
15	1-131-390-00 (D)	1-131-384-00 (B)	1-131-378-00 (B)	1-131-372-00 (B)	1-131-366-00 (C)	1-131-360-00 (D)	-
22	1-131-391-00 (B)	1-131-385-00 (B)	1-131-379-00 (C)	1-131-373-00 (C)	1-131-367-00 (D)	-	-
33	1-131-392-00 (B)	1-131-386-00 (C)	1-131-380-00 (C)	1-131-374-00 (D)	-	-	-
47	1-131-393-00 (C)	1-131-387-00 (C)	1-131-381-00 (D)	-	-	-	-
68	1-131-394-00 (D)	1-131-388-00 (C)	-	-	-	-	-
100	1-131-395-00 (D)	-	-	-	-	-	-

## TANTALUM CAPACITORS

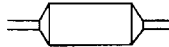

CAP. (μF)	RATING					
	3 VOLT.	6.3 VOLT.	10 VOLT.	16 VOLT.	20 VOLT.	35 VOLT.
0.033						1-131-273-00 (E)
0.047						1-131-274-00 (E)
0.068						1-131-275-00 (E)
0.1						1-131-276-00 (E)
0.15						1-131-277-00 (D)
0.22					1-131-262-00 (D)	1-131-278-00 (D)
0.33					1-131-263-00 (D)	1-131-279-00 (D)
0.47			1-131-169-00 (D)		1-131-264-00 (D)	1-131-280-00 (D)
0.68				1-131-258-00 (D)	1-131-265-00 (D)	1-131-281-00 (D)
1.0			1-131-254-00 (D)		1-131-266-00 (D)	1-131-282-00 (D)
1.5		1-131-250-00 (D)			1-131-267-00 (D)	1-131-283-00 (E)
2.2				1-131-259-00 (D)	1-131-268-00 (D)	1-131-284-00 (E)
3.3					1-131-269-00 (D)	-
4.7		1-131-251-00 (E)	1-131-255-00 (D)		1-131-270-00 (D)	-
6.8			1-131-171-00 (D)		1-131-271-00 (E)	-
10				1-131-256-00 (D)	1-131-272-00 (E)	-
15		1-131-252-00 (D)		1-131-261-00 (E)	-	-
22					-	-
33	1-131-176-00 (D)	1-131-253-00 (E)	1-131-257-00 (E)		-	-
47	1-131-288-00 (F)	1-131-174-00 (D)	1-131-173-00 (C)		-	-
100	1-131-177-00 (D)				-	-

**1/4 WATT CARBON RESISTORS <sup>Ⓐ</sup>**

**Note:** Circled letter <sup>Ⓐ</sup> is applicable to European models only.

Ω	Part No.	Ω	Part No.	Ω	Part No.	Ω	Part No.	Ω	Part No.	Ω	Part No.	Ω	Part No.
1.0	1-246-401-00	10	1-246-425-00	100	1-246-449-00	1.0k	1-246-473-00	10k	1-246-497-00	100k	1-246-521-00	1.0M	1-246-545-00
1.1	1-246-402-00	11	1-246-426-00	110	1-246-450-00	1.1k	1-246-474-00	11k	1-246-498-00	110k	1-246-522-00	1.1M	1-210-814-00
1.2	1-246-403-00	12	1-246-427-00	120	1-246-451-00	1.2k	1-246-475-00	12k	1-246-499-00	120k	1-246-523-00	1.2M	1-210-815-00
1.3	1-246-404-00	13	1-246-428-00	130	1-246-452-00	1.3k	1-246-476-00	13k	1-246-500-00	130k	1-246-524-00	1.3M	1-210-816-00
1.5	1-246-405-00	15	1-246-429-00	150	1-246-453-00	1.5k	1-246-477-00	15k	1-246-501-00	150k	1-246-525-00	1.5M	1-210-817-00
1.6	1-246-406-00	16	1-246-430-00	160	1-246-454-00	1.6k	1-246-478-00	16k	1-246-502-00	160k	1-246-526-00	1.6M	1-210-818-00
1.8	1-246-407-00	18	1-246-431-00	180	1-246-455-00	1.8k	1-246-479-00	18k	1-246-503-00	180k	1-246-527-00	1.8M	1-210-819-00
2.0	1-246-408-00	20	1-246-432-00	200	1-246-456-00	2.0k	1-246-480-00	20k	1-246-504-00	200k	1-246-528-00	2.0M	1-210-820-00
2.2	1-246-409-00	22	1-246-433-00	220	1-246-457-00	2.2k	1-246-481-00	22k	1-246-505-00	220k	1-246-529-00	2.2M	1-210-821-00
2.4	1-246-410-00	24	1-246-434-00	240	1-246-458-00	2.4k	1-246-482-00	24k	1-246-506-00	240k	1-246-530-00	2.4M	1-244-754-00
2.7	1-246-411-00	27	1-246-435-00	270	1-246-459-00	2.7k	1-246-483-00	27k	1-246-507-00	270k	1-246-531-00	2.7M	1-244-755-00
3.0	1-246-412-00	30	1-246-436-00	300	1-246-460-00	3.0k	1-246-484-00	30k	1-246-508-00	300k	1-246-532-00	3.0M	1-244-756-00
3.3	1-246-413-00	33	1-246-437-00	330	1-246-461-00	3.3k	1-246-485-00	33k	1-246-509-00	330k	1-246-533-00	3.3M	1-244-757-00
3.6	1-246-414-00	36	1-246-438-00	360	1-246-462-00	3.6k	1-246-486-00	36k	1-246-510-00	360k	1-246-534-00	3.6M	1-244-758-00
3.9	1-246-415-00	39	1-246-439-00	390	1-246-463-00	3.9k	1-246-487-00	39k	1-246-511-00	390k	1-246-535-00	3.9M	1-244-759-00
4.3	1-246-416-00	43	1-246-440-00	430	1-246-464-00	4.3k	1-246-488-00	43k	1-246-512-00	430k	1-246-536-00	4.3M	1-244-760-00
4.7	1-246-417-00	47	1-246-441-00	470	1-246-465-00	4.7k	1-246-489-00	47k	1-246-513-00	470k	1-246-537-00	4.7M	1-244-761-00
5.1	1-246-418-00	51	1-246-442-00	510	1-246-466-00	5.1k	1-246-490-00	51k	1-246-514-00	510k	1-246-538-00	5.1M	1-244-762-00
5.6	1-246-419-00	56	1-246-443-00	560	1-246-467-00	5.6k	1-246-491-00	56k	1-246-515-00	560k	1-246-539-00		
6.2	1-246-420-00	62	1-246-444-00	620	1-246-468-00	6.2k	1-246-492-00	62k	1-246-516-00	620k	1-246-540-00		
6.8	1-246-421-00	68	1-246-445-00	680	1-246-469-00	6.8k	1-246-493-00	68k	1-246-517-00	680k	1-246-541-00		
7.5	1-246-422-00	75	1-246-446-00	750	1-246-470-00	7.5k	1-246-494-00	75k	1-246-518-00	750k	1-246-542-00		
8.2	1-246-423-00	82	1-246-447-00	820	1-246-471-00	8.2k	1-246-495-00	82k	1-246-519-00	820k	1-246-543-00		
9.1	1-246-424-00	91	1-246-448-00	910	1-246-472-00	9.1k	1-246-496-00	91k	1-246-520-00	910k	1-246-544-00		

**HARDWARE NOMENCLATURE**

Screw:

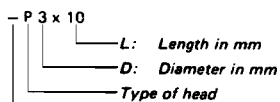

Indicated slotted-head only.  
Unless otherwise indicated, it means cross-recessed head (Phillips type).

Nut, Washer, Retaining ring:

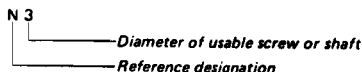

Reference Designation	Shape	Description	Remarks
<b>SCREWS</b>			
P		pan-head screw	binding-head (B) screw for replacement
PWH		pan-head screw with washer face	binding-head (B) screw and flat washer for replacement
PS PSP		pan-head screw with spring washer	binding-head (B) screw and spring washer for replacement
PSW PSPW		pan-head screw with spring and flat washers	binding-head (B) screw and spring and flat washers for replacement
R		round-head screw	binding-head (B) screw for replacement
K		flat-countersunk-head screw	
RK		oval-countersunk-head screw	
B		binding-head screw	
T		truss-head screw	binding-head (B) screw for replacement
F		flat-fillister-head screw	
RF		fillister-head screw	
BV		braizer-head screw	

Reference Designation	Shape	Description	Remarks
<b>SELF-TAPPING SCREWS</b>			
TA		self-tapping screw	ex: TA, P 3 x 10
PTP		pan-head self-tapping screw	binding-head self-tapping (TA, B) screw for replacement
PTPWH		pan-head self-tapping screw with washer face	binding-head self-tapping (TA, B) screw and flat washer for replacement
PTTWH		pan-head thread-rolling screw with washer face	binding-head (B) screw and flat washer for replacement
<b>SET SCREWS</b>			
SC		set screw	
SC		hexagon-socket set screw	ex: SC 2.6 x 4, hexagon socket
<b>NUT</b>			
N		nut	
<b>WASHERS</b>			
W		flat washer	
SW		spring washer	
LW		internal-tooth lock washer	ex: LW3, internal
LW		external-tooth lock washer	ex: LW3, external
<b>RETAINING RINGS</b>			
E		retaining ring	
G		grip-type retaining ring	



*AEP Model*  
*UK Model*  
*SCN Model*

**SUPPLEMENT**

File this supplement with the service manual.

No. 1  
December 1979

**PRODUCTION CHANGE**

**COUNTER and EQ BOARD**

AEP Model

Serial No. 505701 and later

UK Model

Serial No. 600501 and later

SCN Model

Serial No. 550001 and later

**TUNER BOARD**

AEP Model

Serial No. 505801 and later

UK Model

Serial No. 601501 and later

SCN Model

Serial No. 550001 and later

## MOUNTING DIAGRAM

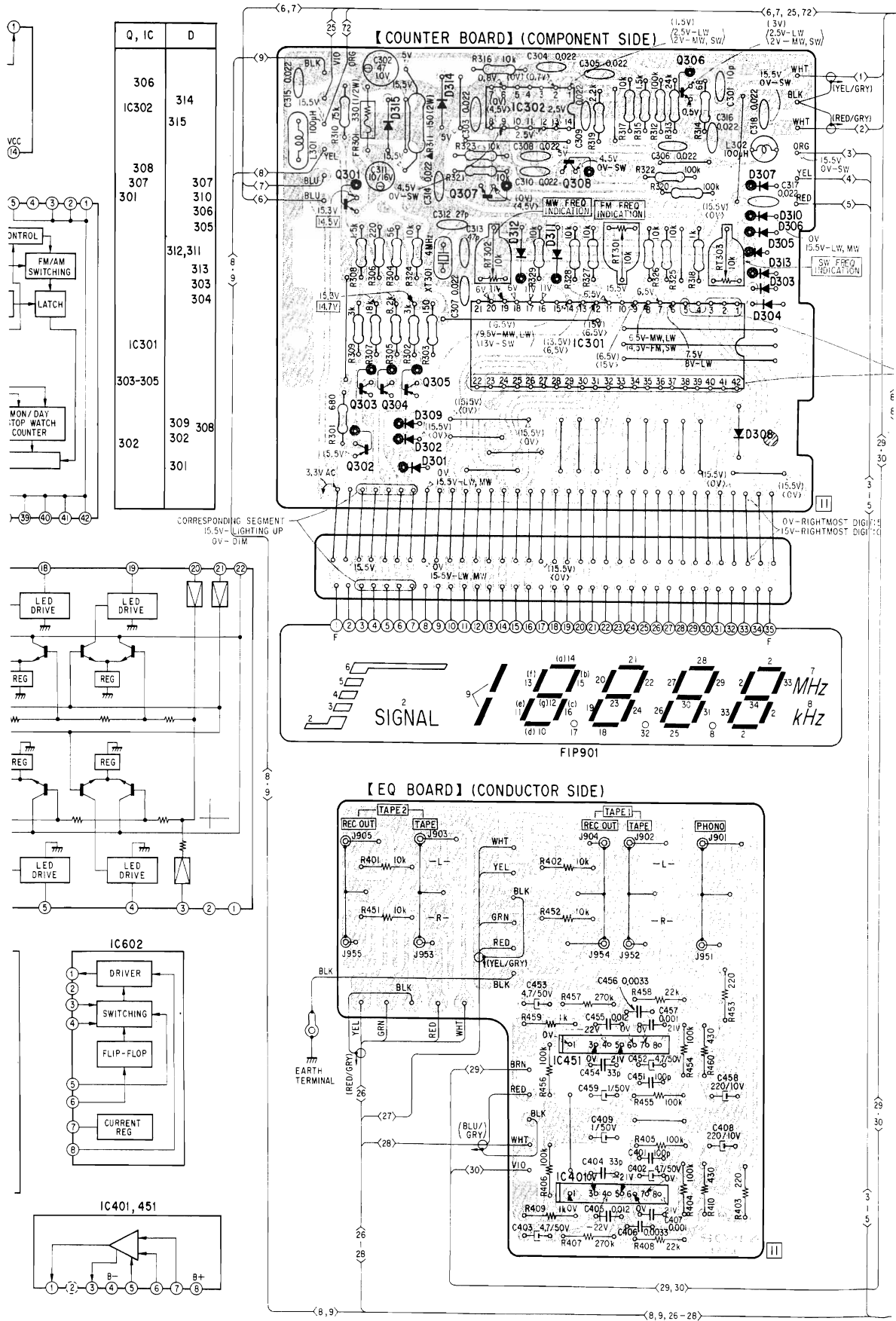



# STR-434L STR-434L

*Scanned*

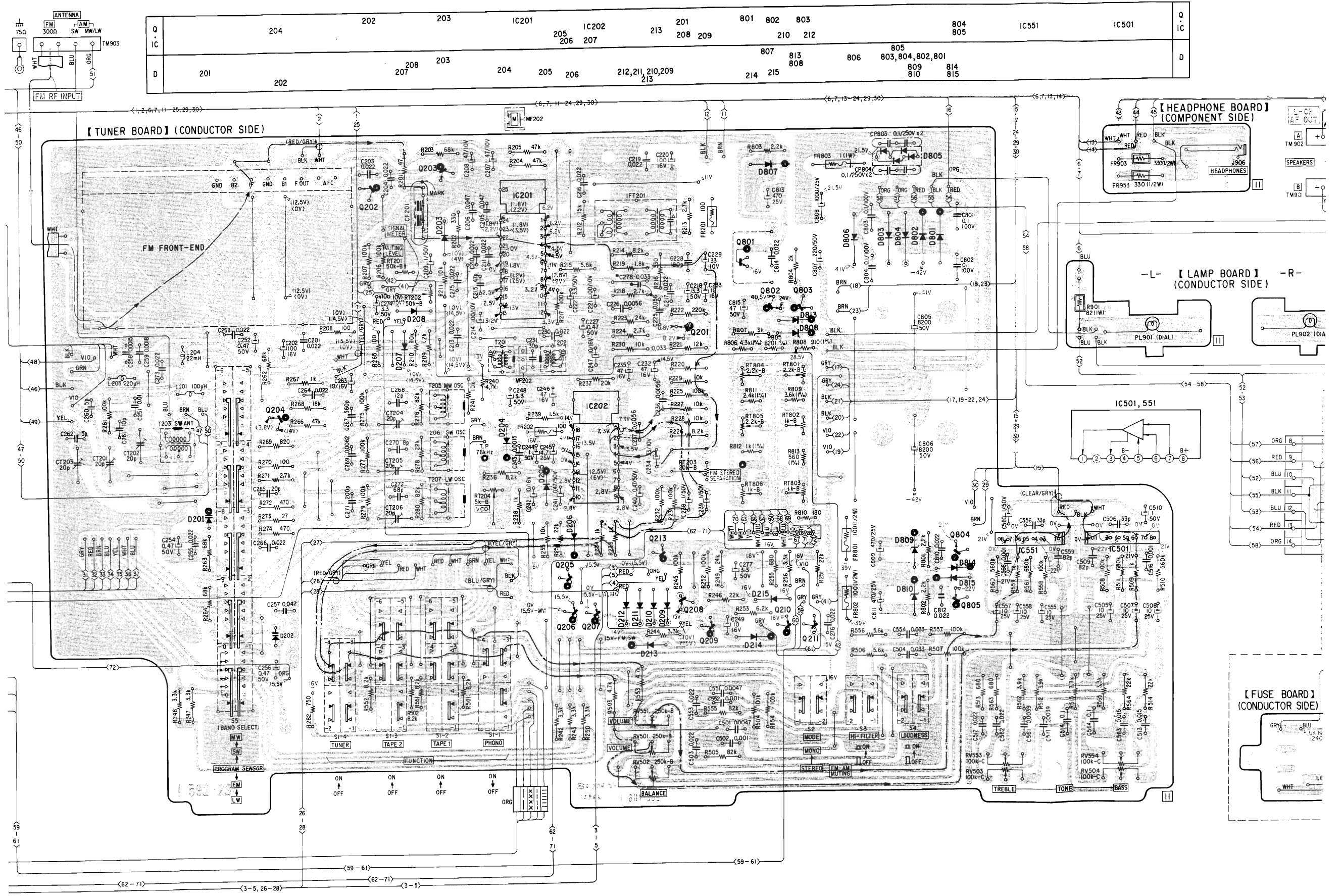

**SCHEMATIC DIAGRAM**

