

ALIGNMENTS AND ADJUSTMENTS

FM FREQUENCY COVERAGE AND TRACKING ALIGNMENT

Never attempt alignment of the fm front-end section for the fm frequency coverage and tracking alignment. If the fm frequency coverage alignment is required, replace the fm front-end board.

In the case of tracking alignment, ask your nearest SONY Service Station to send your set to the Factory Service Center.

AM FREQUENCY COVERAGE AND AM TRACKING ALIGNMENT

Test setup:

FUNCTION selector: AM

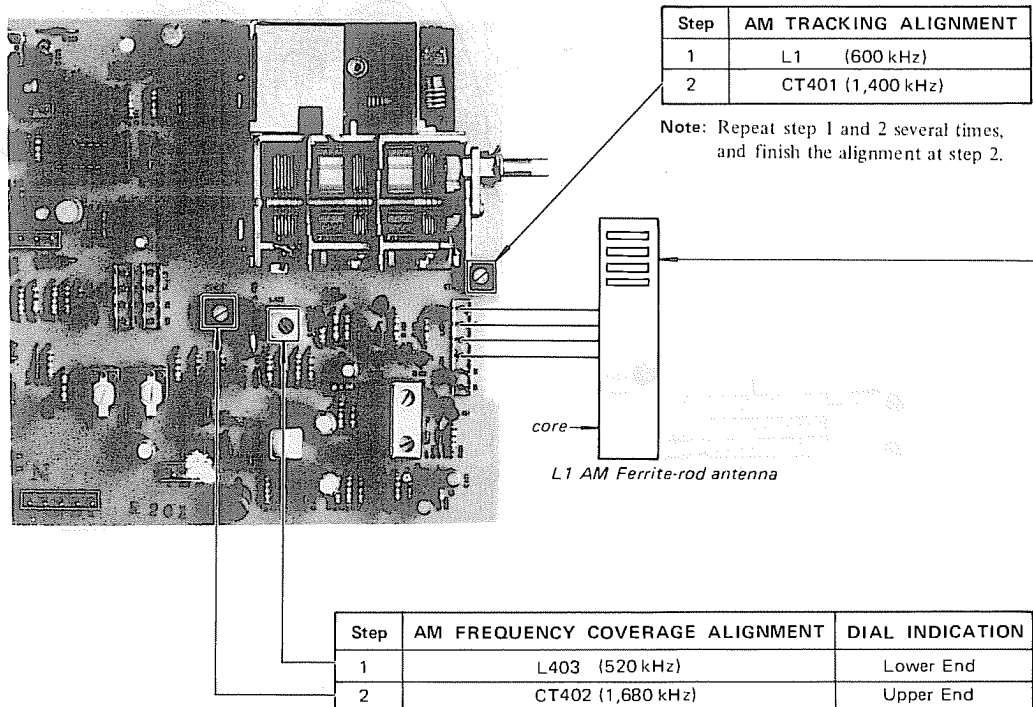
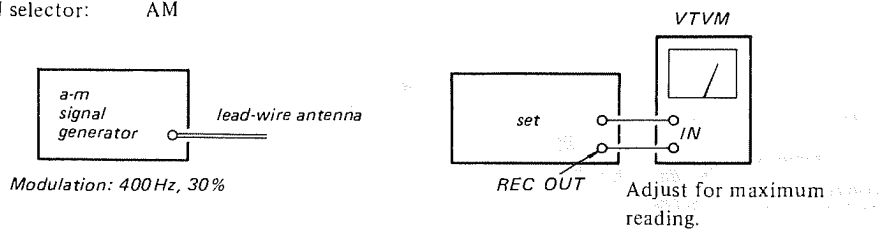

Note: Repeat step 1 and 2 several times, and finish the alignment at step 2.

2-6. DIAL CORD STRINGING

1) Dial Cord Length

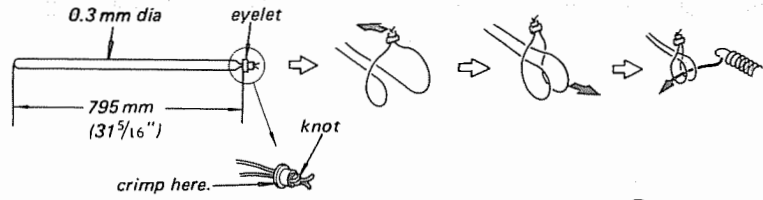

2) Dial Cord Stringing

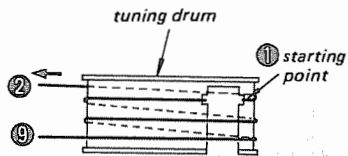
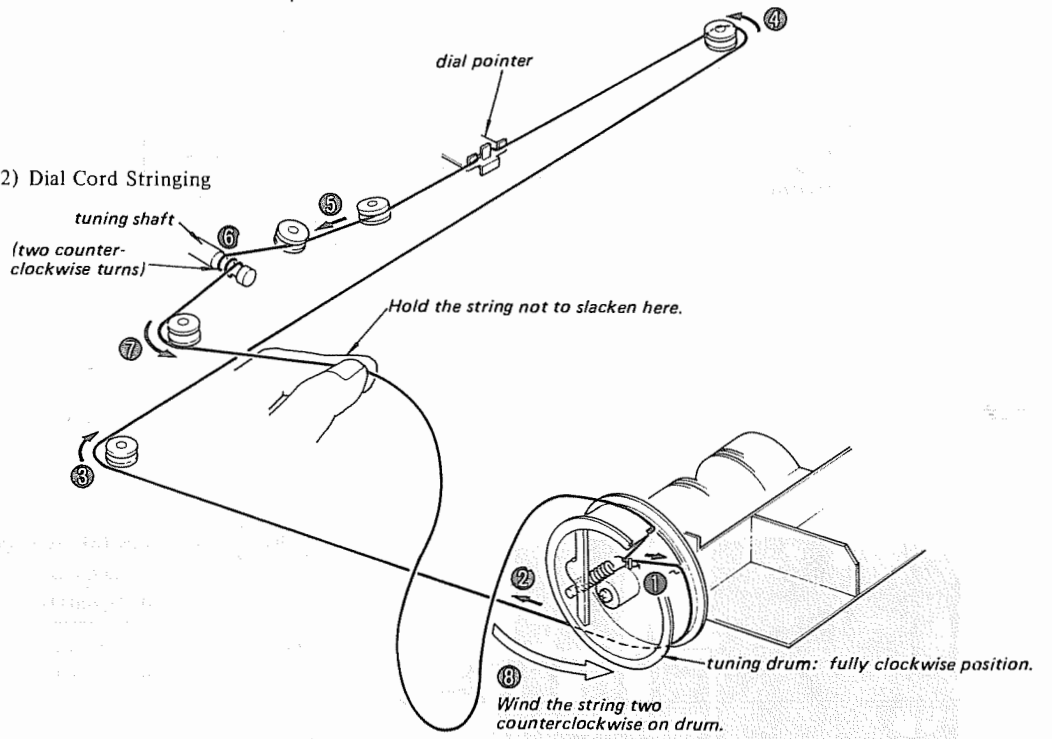

Set the string on the drum finally.

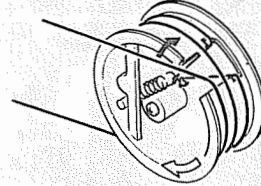

MPX ADJUSTMENT

Setup:

FUNCTION selector: FM
frequency counter

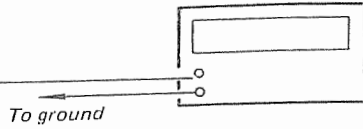

FM Signal Generator Setting:

Carrier frequency: 98 MHz
Modulation: no modulation
Output level: 3.2 mV (70 dB)

Procedure:

Adjust RT203 for 19 kHz \pm 100 Hz on the counter.

DISCRIMINATOR ALIGNMENT

Procedure:

FUNCTION selector: FM

1. Detune the set.
2. Adjust the secondary side core of IFT201 for zero center on the TUNING meter as shown.

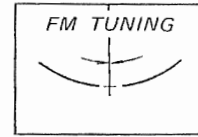

IFT201 (secondary side)

RT203

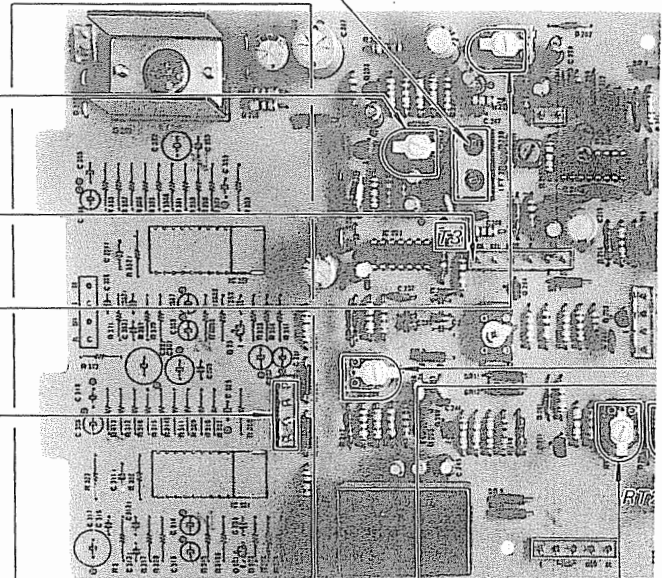

FM OUTPUT LEVEL ADJUSTMENT

Setup:

FUNCTION selector: FM

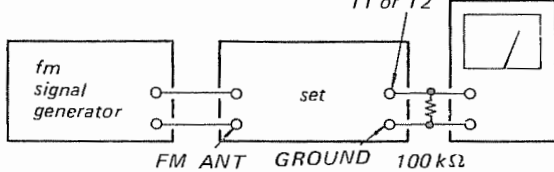

FM Signal Generator Setting:

Carrier frequency: 98 MHz
Modulation: 400 Hz, 75 kHz deviation (100%)
Output level: 1 mV (60 dB)

Procedure:

Adjust RT202 for 870 mV on the VTVM.

RT202

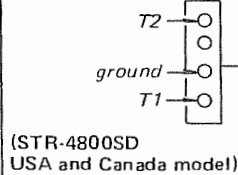
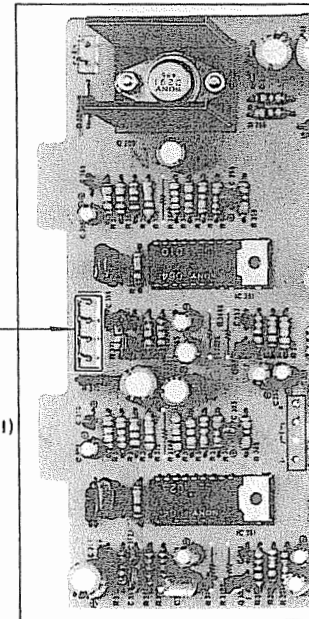
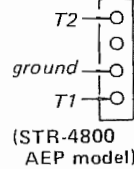

SIGNAL METER CALIBRATION

Setup:

FUNCTION selector: FM

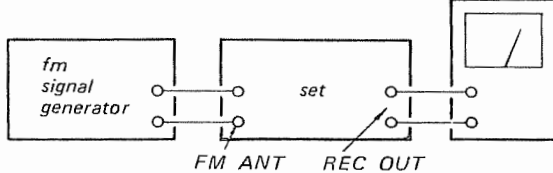

FM Signal Generator Setting:

Carrier frequency: 98 MHz
Modulation: no modulation
Output level: 3.2 mV (70 dB)

Procedure:

Tune the set to 98 MHz and adjust RT201 for specified pointer position on the SIGNAL meter as shown.

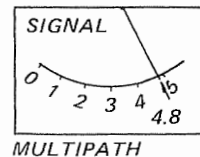

RT201

MUTIN

Setup:

FUN
MUT

fm
signa
gener

FM Sig
Carri
Mod

Procedu

1. Set
5.6 k
2. Adju
disaj

FM IF ALIGNMENT

Setup:

FUNCTION selector: FM VTVM

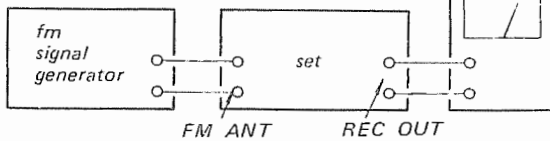

FM Signal Generator Setting:

Carrier frequency: 98 MHz
 Modulation: 400 Hz, 75 kHz deviation
 (100%)
 Output level: 1 mV (60 dB)

Procedure:

Tune the set to 98 MHz and adjust IFT101 for maximum reading on the VTVM.

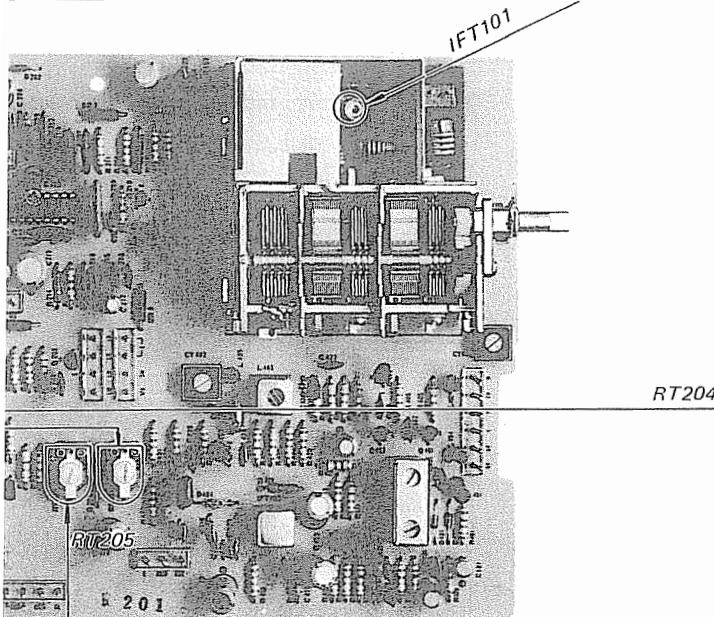

FM STEREO SEPARATION ADJUSTMENT

Setup:

FUNCTION selector: FM VTVM

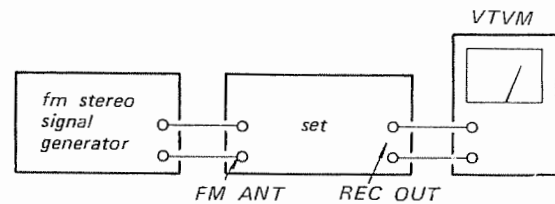

FM Stereo Signal Generator Setting:

Carrier frequency: 98 MHz
 Mode: Stereo
 Audio (400 Hz) Modulation: 67.5 kHz (90%)
 Pilot (19 kHz) Modulation: 7.5 kHz (10%)

Procedure:

1. Tune the set to 98 MHz.
 2. Set the signal generator channel selector to L-CH.
 3. Connect the VTVM to the REC OUT "L-CH" of the set and read the output level on the VTVM.
 4. Turn the stereo signal generator channel selector from L-CH to R-CH and adjust RT204 for minimum output on the VTVM.
- Note:** The output level difference between step 3 and step 4 represents the separation.
5. Connect the VTVM to the REC OUT "R-CH" of the set and read the output level on the VTVM.
 6. Turn the stereo signal generator channel selector from R-CH to L-CH and adjust RT204 for minimum output on the VTVM.
 7. If the separations obtained in step 4 and step 6 differ more than 3 dB in value, readjust RT204 to be less than 3 dB.

MUTING LEVEL ADJUSTMENT

Setup:

FUNCTION selector: FM
 MUTING switch: ON

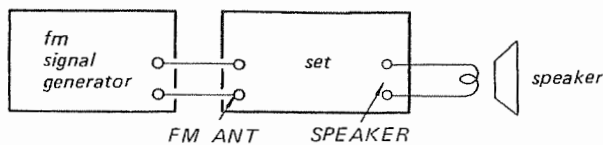

FM Signal Generator Setting:

Carrier frequency: 98 MHz
 Modulation: 400 Hz, 75 kHz deviation
 (100%)

Procedure:

1. Set the output level of the fm signal generator to $5.6 \mu\text{V}$ (15 dB).
2. Adjust RT205 for the point that the sound just disappears.

BLOCK DIAGRAM

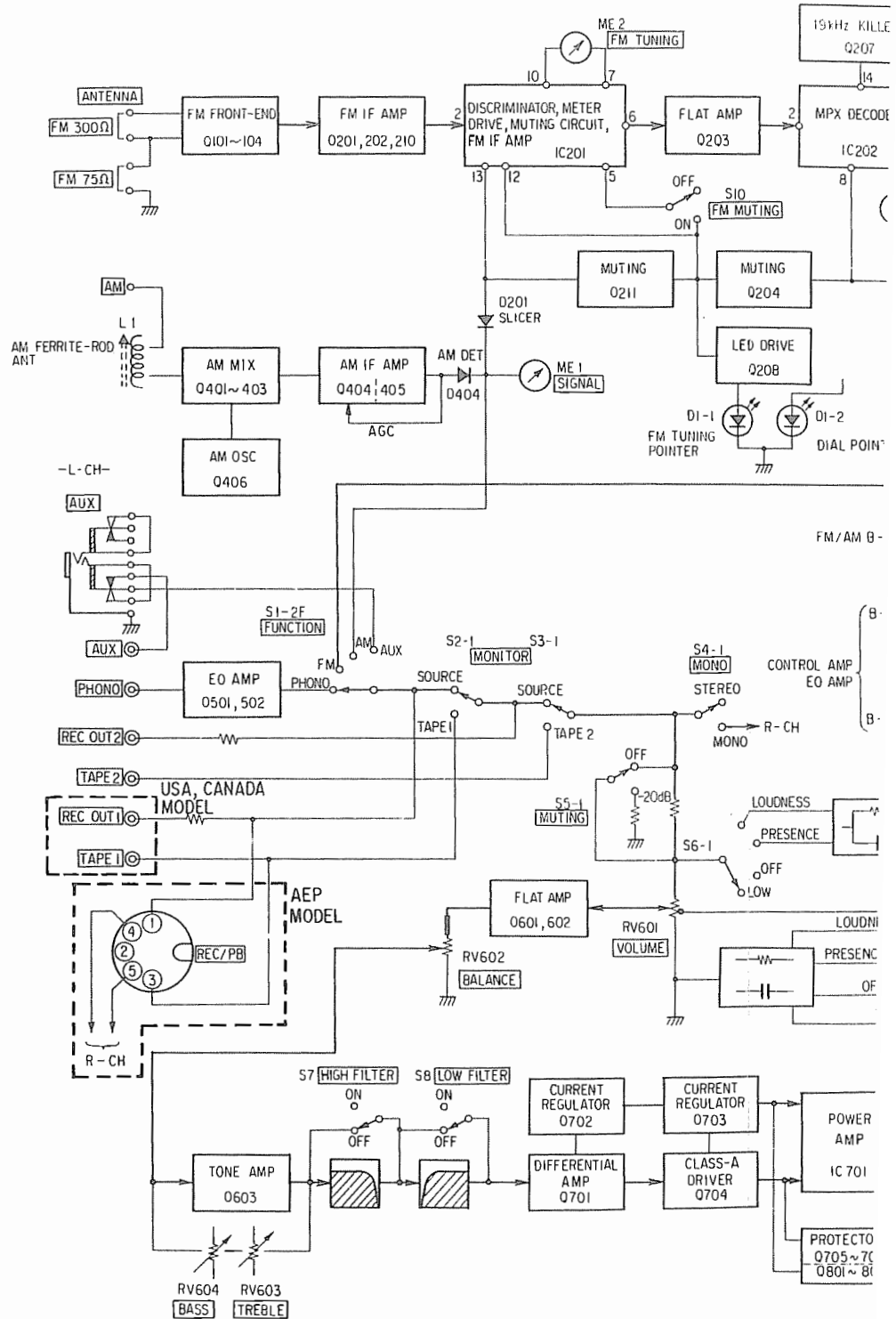

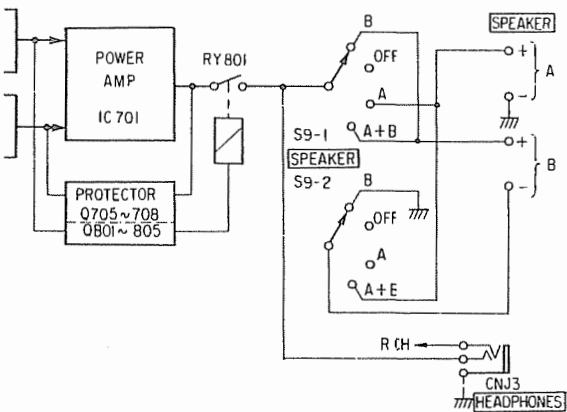
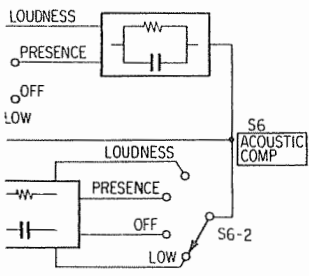
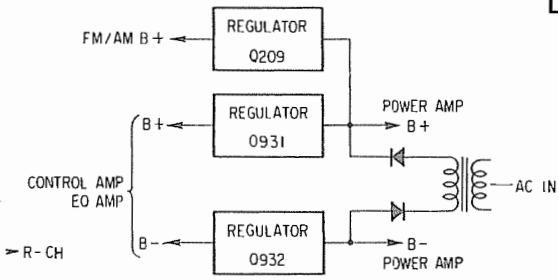
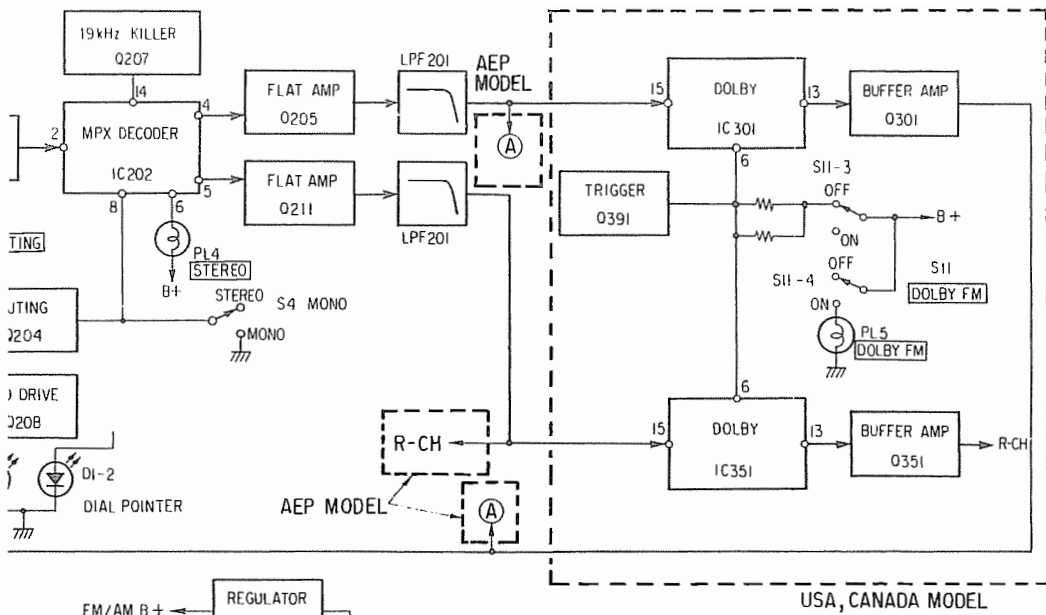

Note: The circled letters (A to Z) are applicable for the European models only.

ELECTRICAL PARTS LIST

Ref. No. Part No. Description

SEMICONDUCTORS

Transistors

⇒ Q201, 202	(B) 2SC403C
⇒ Q203	(B) 2SC632A
Q204	(B) 2SC945
⇒ Q205, 206	(B) 2SC632A
Q207, 208	(B) 2SC945
Q209	(D) 2SD291
⇒ Q210	(B) 2SC403C
Q211	(B) 2SC945
⇒ Q401 ~ 403	(B) 2SC403C
Q405, 406	(B) 2SC710
Q501, 551	(B) 2SC1636
Q502, 552	(B) 2SA705
Q601, 651	(B) 2SC1636
Q602, 652	(B) 2SA705
Q603, 653	(B) 2SC632A
Q701, 751	(B) 2SA705
Q703, 753	(C) 2SA896
Q704, 754	(C) 2SC1811
⇒ Q705, 755	(C) 2SA678
⇒ Q706, 756, Q707, 757	(B) 2SC634A
⇒ Q708, 758	(C) 2SA678
⇒ Q801 ~ 803	(C) 2SA678
⇒ Q804	(B) 2SC634A
Q805	(C) 2SC1811
Q931	(E) 2SC1124
Q932	(C) 2SA706
	ICs
IC201	(H) HA1137W
IC202	(J) HA1156
IC701, 751	(L) SS050A

Ref. No. Part No. Description

Diodes

D1	(H) TX312
⇒ D201, 202	(B) 1S1555
D203	(B) 1T22A
⇒ D204	(B) EQB01-26
D205	(B) 10E2
⇒ D261	(B) 1S1555
⇒ D401, 402	(B) 1S1555
D403, 404	(B) 1T22A
D601	(B) 1S1555
D701, 751	(B) VD1221
D702 ~ 705, D752 ~ 755	(B) 1S1555
D801 ~ 803	(B) 1S1555
D804	(B) 1T243M
D805, 806	(B) 1S1555
D901 ~ 904	(C) U05E
D911, 912	(B) 10E2
D913, 914	(B) 10D2
⇒ D931, 932	(B) EQB01-21

THERMISTOR

Pth801, 851 1-800-427-00 (B) Positive

COILS

L1	1-401-635-21 (G) AM Ferrite-rod Ant
L201	1-459-152-00 (B) 18 μH
L401	1-407-169-XX (A) microinductor, 100 μH
L402	1-407-182-XX (A) microinductor, 2.2 μH
L403	1-405-656-00 (B) AM Osc
L404	1-407-178-XX (A) microinductor, 1 μH
L405	1-407-182-XX (A) microinductor, 2.2 μH

⇒ : Due to replacement parts, the descriptions are different from the diagrams.

Note: The circled letters (A to Z) are applicable for the European models only.

Ref. No.	Part No.	Description
TRANSFORMERS		
B1	1-417-014-31	(B) Balun
IFT201	1-404-029-00	(C) FM Discriminator
IFT401	1-404-014-11	(D) AM IFT (USA, Canada model)
	1-404-014-21	(D) AM IFT (AEP model)
IFT402	1-403-149-00	(B) AM IFT
PT1	1-442-602-00	(Q) Power (USA model)
	1-442-646-00	(Q) Power (Canada model)
	1-442-647-00	(Q) Power (AEP model)

FILTERS		
CF201, 202	1-527-248-XX	(H) Ceramic
LPF201	1-231-219-00	(D) Low-pass

CAPACITORS

All capacitors are in μF and of electrolytic unless otherwise noted. ($p = \mu\mu\text{F}$)
50 and/or less working voltages are omitted except for electrolytic type.

C101	1-121-970-11	(A) 47	16 V	
C102	1-101-924-11	(A) 0.022		ceramic
C201 ~ 203	1-101-924-11	(A) 0.022		ceramic
C206	1-101-924-11	(A) 0.022		ceramic
C207 ~ 209	1-101-925-11	(A) 0.047		ceramic
C210	1-121-391-11	(A) 1	50 V	
C211	1-102-820-11	(A) 330 p		ceramic
C212	1-121-391-11	(A) 1	50 V	
C213	1-121-415-11	(B) 100	16 V	
C214	1-101-925-11	(A) 0.047		ceramic
C215, 216	1-101-924-11	(A) 0.022		ceramic
C217	1-101-925-11	(A) 0.047		ceramic
C218	1-121-726-11	(A) 0.47	50 V	
C219	1-121-392-11	(A) 3.3	25 V	
C220, 221	1-121-651-11	(A) 10	16 V	
C222	1-121-972-11	(B) 220	16 V	
C223	1-121-651-11	(A) 10	16 V	
C224	1-103-717-11	(A) 470 p		polystyrol
C225	1-101-924-11	(A) 0.022		ceramic

Ref. No.	Part No.	Description
C226	1-108-246-12	(A) 0.047 mylar
C227	1-121-651-11	(A) 10 16 V
C228, 229	1-121-726-11	(A) 0.47 50 V
C230	1-127-019-11	(B) 0.1 10 V solid aluminum
C231	1-123-068-11	(B) 220 16 V
C232, 233	1-108-580-12	(A) 0.011 mylar (AEP model)
	1-108-571-12	(A) 0.0047 mylar (USA, Canada model)
C234	1-101-924-11	(A) 0.022 ceramic
C235, 236	1-108-573-12	(A) 0.0056 mylar (AEP model)
	1-108-581-12	(A) 0.012 mylar (USA, Canada model)
C239	1-121-651-11	(A) 10 16 V
C240	1-127-021-11	(B) 0.33 10 V solid aluminum
C241	1-101-880-11	(A) 47 p ceramic
C242	1-121-651-11	(A) 10 16 V
C243	1-127-021-11	(B) 0.33 10 V solid aluminum
C244	1-101-880-11	(A) 47 p ceramic
C245	1-121-651-11	(A) 10 16 V
C246	1-123-068-11	(B) 220 16 V
C247	1-121-936-11	(B) 220 25 V
C251, 252	1-102-732-11	(A) 75 p ceramic
C261	1-102-959-11	(A) 22 p ceramic
(USA, Canada model)		
C301, 351	1-121-391-11	(A) 1 50 V
C302, 352	1-121-479-11	(A) 22 16 V
C303, 353	1-102-947-11	(A) 10 p ceramic
C305, 355	1-131-198-11	(B) 6.8 16 V tantalum
C307, 357	1-121-409-11	(A) 47 16 V
C308, 358	1-121-391-11	(A) 1 50 V
C309, 359	1-108-244-12	(A) 0.033 mylar
C310, 360	1-131-196-11	(B) 2.2 20 V tantalum
C311, 361	1-108-603-12	(A) 0.1 mylar
C312, 362	1-108-585-12	(A) 0.018 mylar
C313, 363	1-108-587-12	(A) 0.022 mylar
C314, 364	1-121-391-11	(A) 1 50 V
C315, 365	1-121-395-11	(A) 4.7 25 V
C316, 366	1-108-230-12	(A) 0.0022 mylar
C317, 367	1-121-415-11	(A) 100 16 V
C391	1-121-651-11	(A) 10 16 V

STR-4800 (AEP Model)

MOUNTING DIAGRAM – Front-End, FM/AM Circuit Boards –
– Conductor Side –

D	402, 401			403	404		
Q, IC	401	403 402 404	405		406	201 202	210

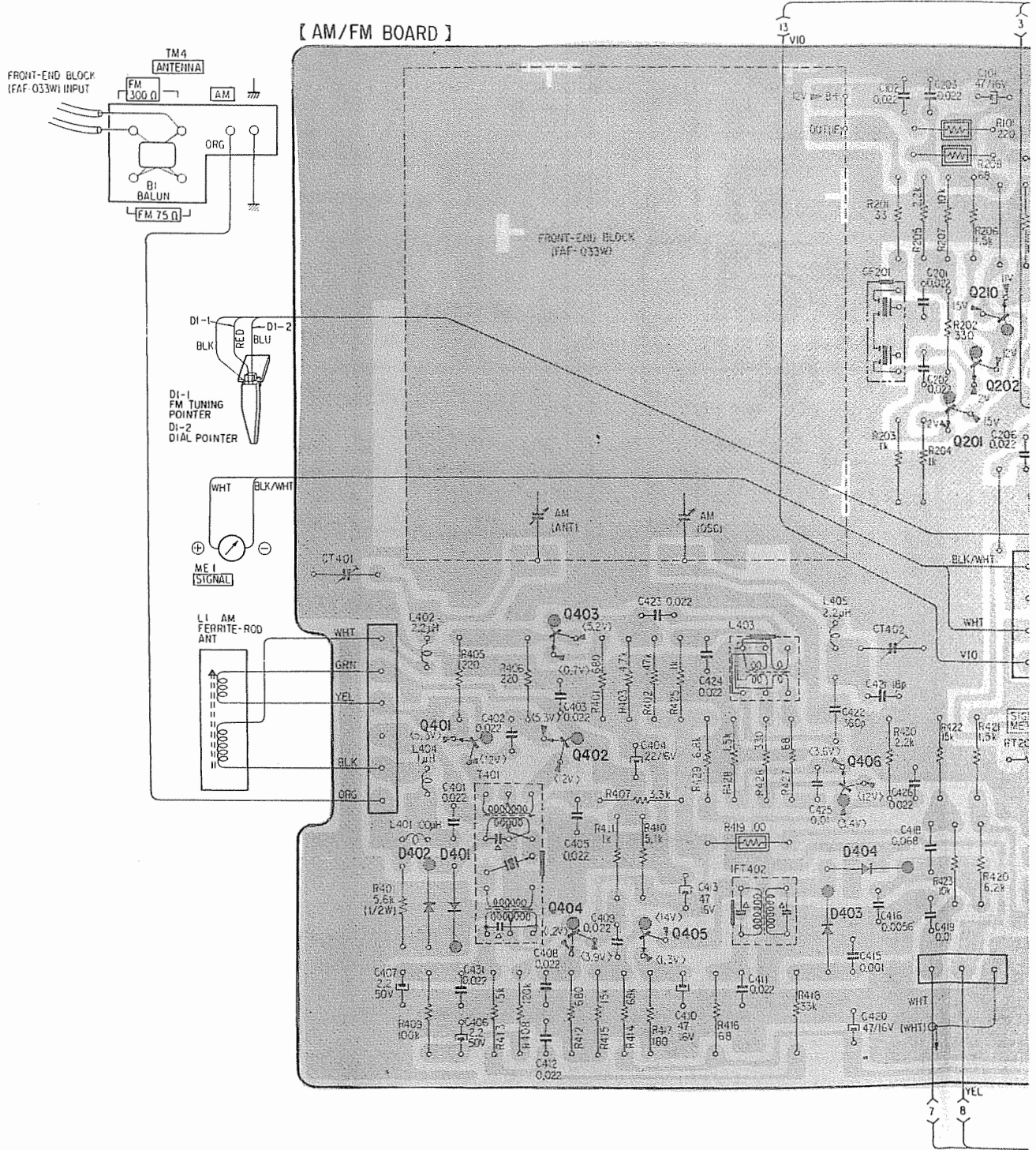

210	201	202	261	203	204	205	206	207	209	205
IC201										

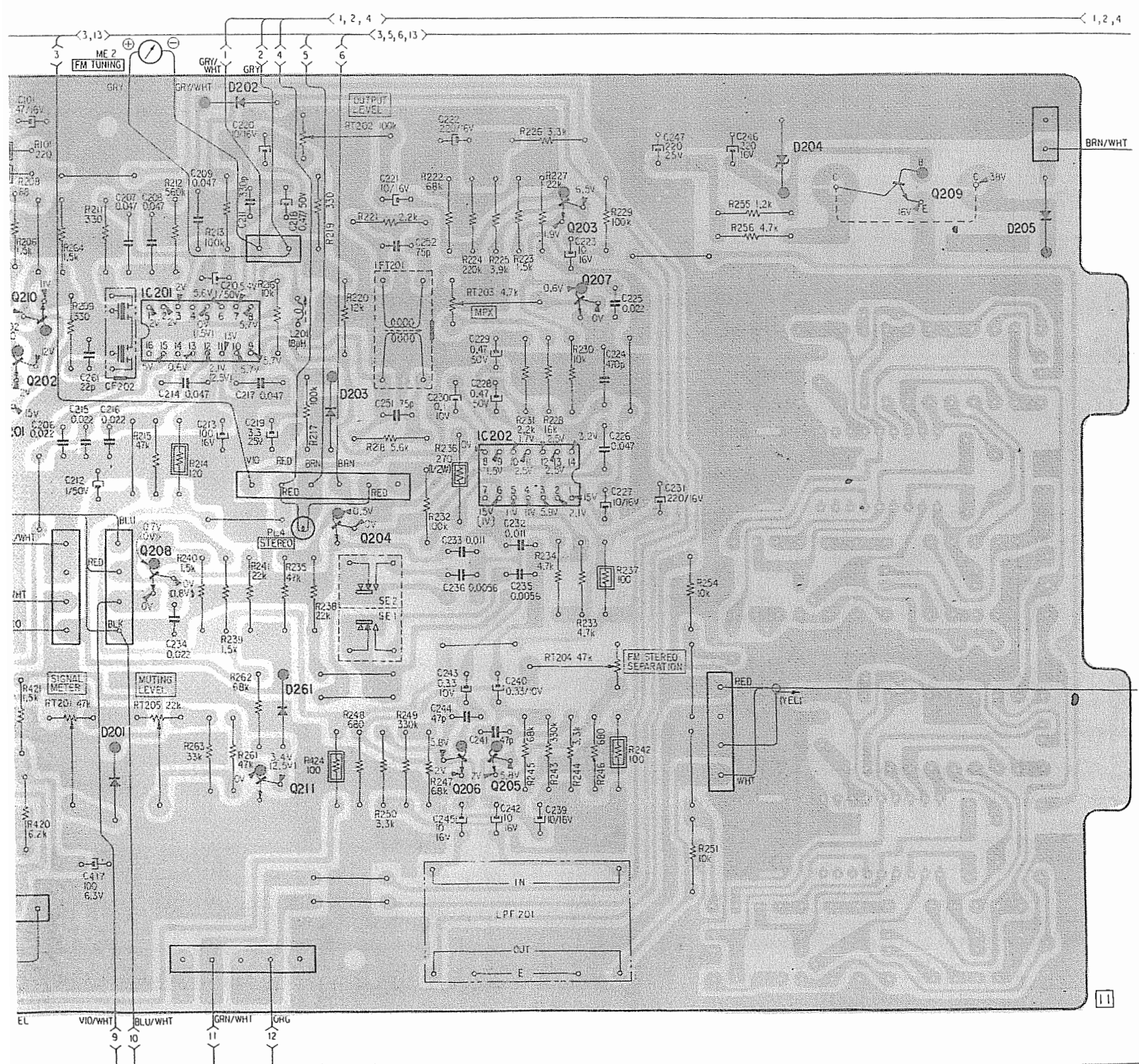

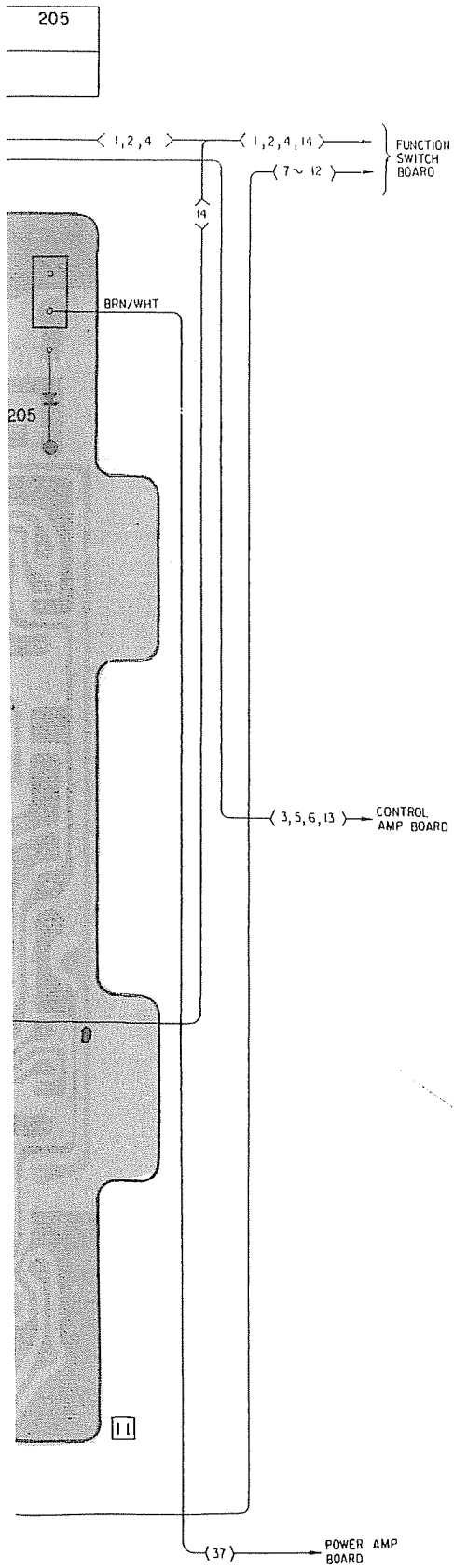

Q201, 202, 210 } 2SC403
 Q410 }
 Q403 : 2SC632A

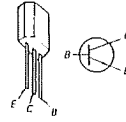

Q204, 207, } 2SC945
 208, 211 }

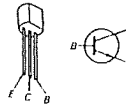

Q209: 2SD291

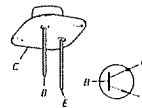

Q405, 406: 2SC710

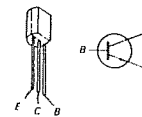

IC201: HA1137W

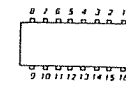

IC202: HA1156

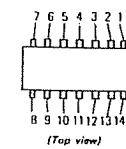

D201, 202 } 1T40
 261, 401, 402 }

D203, 403, 404: 1T22A

D205: 10E2



D204: EQA01-16R



Note: • B+ pattern

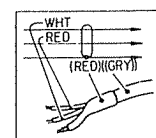

STR-4800SD (USA and Canada Model)

MOUNTING DIAGRAM – Front-End, FM/AM Circuit Boards –
– Conductor Side –

D	402,401	403	405	403	404	201	210
Q, IC	401	402 404	405	406	406	201	202

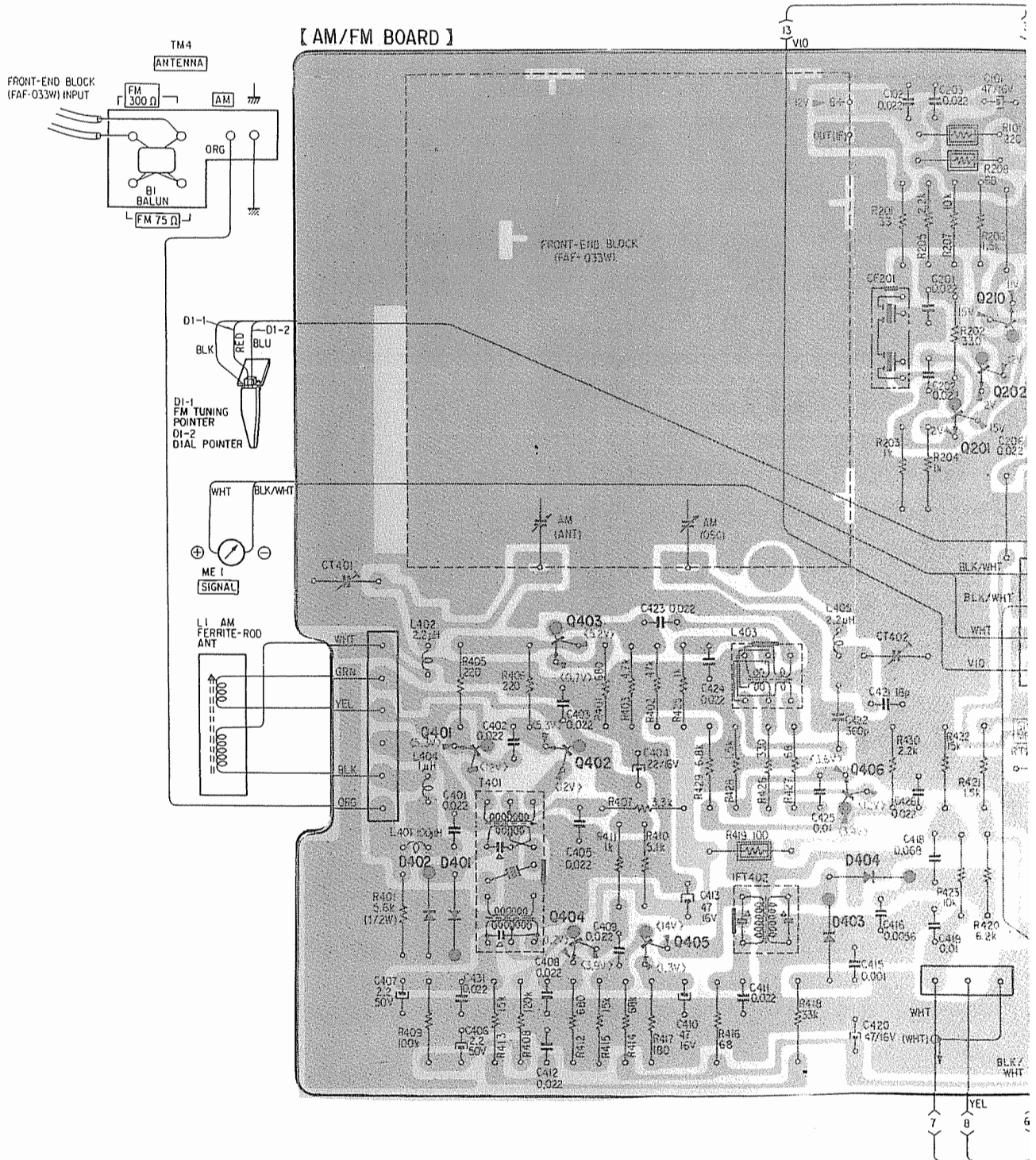

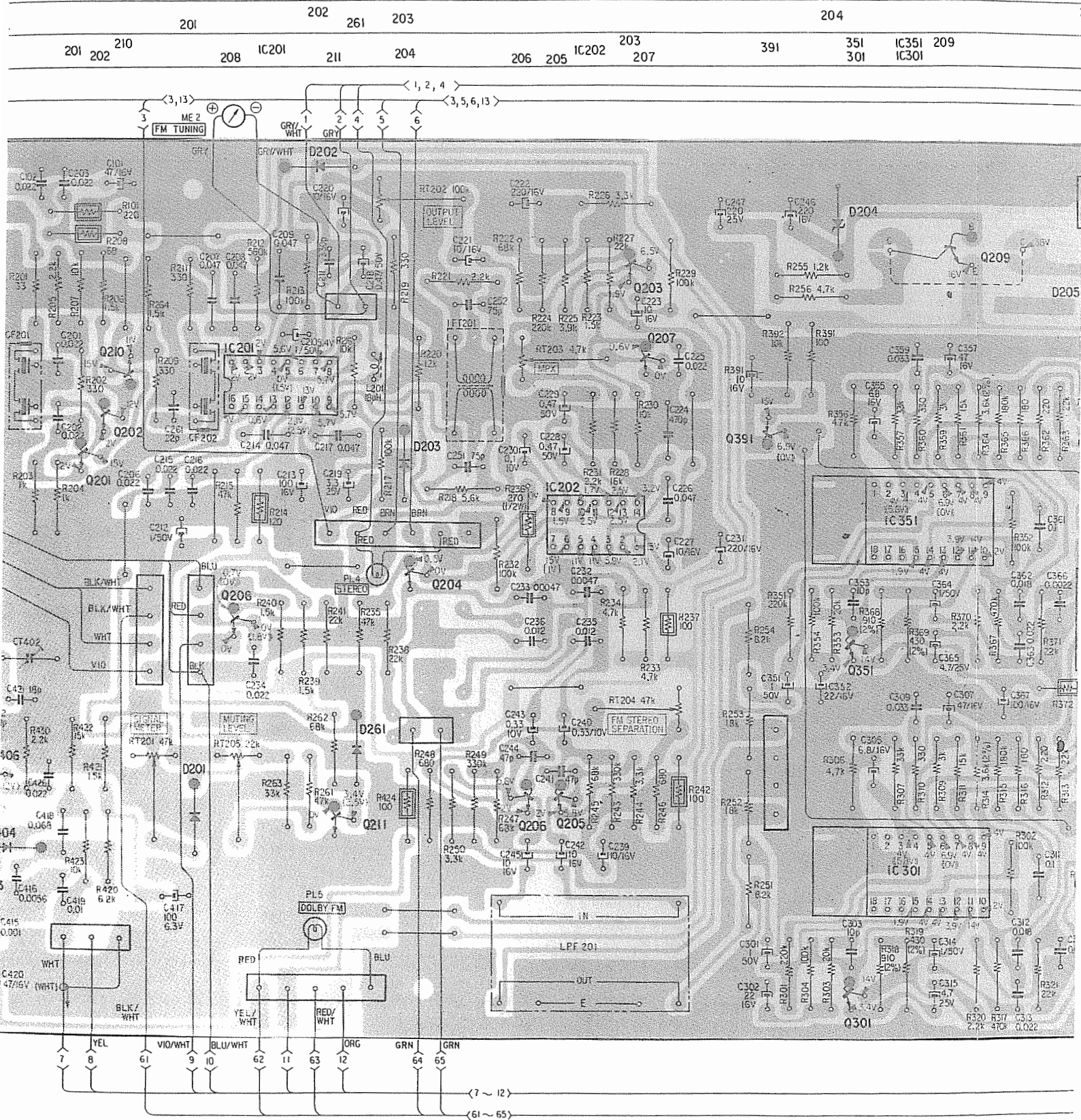

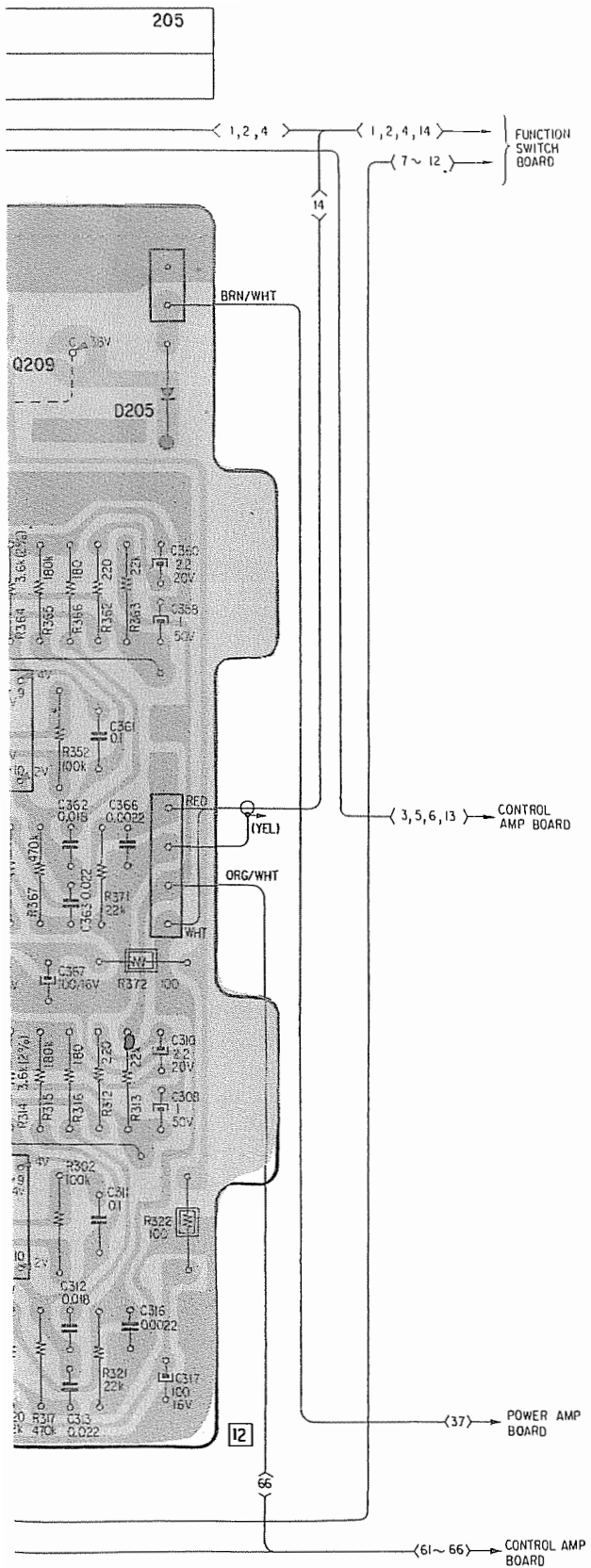

Q201, 202, 210 } : 2SC403
 Q410
 Q403 : 2SC632A

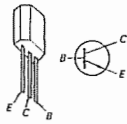

Q204, 207, 208, 211 } : 2SC945

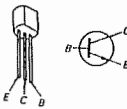

Q209 : 2SD291

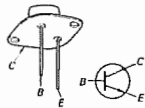

Q301, 351 : 2SC900

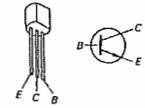

Q391 : 2SA678

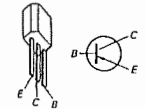

Q405, 406 : 2SC710

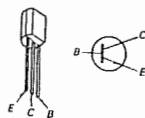

IC201: HA1137W

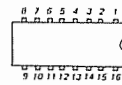

IC202: HA1156

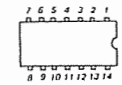

(Top view)

IC301, 351: CX064

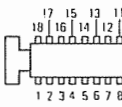

(Top view)

D201, 202 } 1T40
 261, 401, 402 }

D203, 403, 404: 1T22A

D205: 10E2

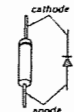

D204: EQA01-16R



Note: ○ B+ pattern

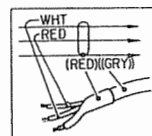

Sony STR-4800, STR-4800SD

Note: The circled letters (A to Z) are applicable for the European models only.

<u>Ref. No.</u>	<u>Part No.</u>	<u>Description</u>
C401 ~403	1-101-924-11 (A)0.022	ceramic
C404	1-121-479-11 (A)22 16 V	
C405	1-101-924-11 (A)0.022	ceramic
C406, 407	1-121-450-11 (A)2.2 50 V	
C408, 409	1-101-924-11 (A)0.022	ceramic
C410	1-121-409-11 (A)47 16 V	
C411, 412	1-101-924-11 (A)0.022	ceramic
C413	1-121-409-11 (A)47 16 V	
C415	1-108-277-12 (A)0.001	mylar
C416	1-108-355-12 (A)0.0056	mylar
C417	1-121-413-11 (A)100 6.3 V	
C418	1-108-249-12 (A)0.068	mylar
C419	1-108-239-12 (A)0.01	mylar
C420	1-121-409-11 (A)47 16 V	
C421	1-102-953-11 (A)18 p	ceramic
C422	1-103-714-11 (A)360 p	polystyrol
C423	1-101-924-11 (A)0.022	ceramic
C424	1-101-924-11 (A)0.022	ceramic
C425	1-108-239-12 (A)0.01	mylar
C426, 431	1-101-924-11 (A)0.022	ceramic
C501, 551	1-121-913-11 (A)3.3 25 V	
C502, 552	1-102-959-11 (A)22 p	ceramic
C503, 553	1-102-824-11 (A)470 p	ceramic
C504, 554	1-108-573-12 (A)0.0056	mylar
C505, 555	1-108-561-12 (B)0.0018	mylar
C506, 556	1-123-077-11 (B)470 6.3 V	(explosion proof)
C507, 557	1-121-912-11 (A)1 50 V	
C601, 651	1-102-976-11 (A)180 p	ceramic
C602, 652	1-108-230-12 (A)0.0022	mylar
C603, 653	1-108-244-12 (A)0.033	mylar
C604, 654	1-108-246-12 (A)0.047	mylar
C605, 655	1-108-227-11 (A)0.001	mylar
C606, 656	1-121-912-11 (A)1 50 V	
C607, 657	1-102-978-11 (A)220 p	ceramic
C608, 658	1-121-413-11 (A)100 6.3 V	
C609, 659	1-102-959-11 (A)22 p	ceramic
C610, 660	1-121-916-11 (B)10 16 V	
C611, 661 C612, 662	1-108-246-12 (A)0.047	mylar

<u>Ref. No.</u>	<u>Part No.</u>	<u>Description</u>
C613, 663	1-108-228-12 (A)0.0015	mylar
C614, 664	1-121-916-11 (B)10 16 V	
C615, 665	1-121-913-11 (A)3.3 25 V	
C616, 666	1-102-963-11 (A)33 p	ceramic
C617, 667	1-121-915-11 (A)4.7 25 V	
C618, 668	1-121-413-11 (A)100 6.3 V	
C619, 669	1-108-585-12 (B)0.018	mylar
C620, 670	1-108-603-12 (B)0.1	mylar
C701, 751	1-102-116-11 (A)680 p	ceramic
C702, 752	1-121-912-11 (A)1 50 V	
C703, 753	1-123-076-11 (B)330 6.3 V	
C704, 754	1-102-973-11 (A)100 p	ceramic
C706, 756	1-121-413-11 (A)100 6.3 V	
C708, 758 C709, 759	1-123-056-11 (B)22 50 V	
C710, 760	1-108-244-12 (A)0.033	mylar
C761	1-121-413-11 (A)100 6.3 V	
C801	1-121-419-11 (B)220 6.3 V	
C802	1-121-479-11 (A)22 16 V	
C803	1-121-419-11 (B)220 6.3 V	
C804	1-101-004-11 (A)0.01	ceramic
C901, 902	1-125-141-11 (K)4700 50 V	
C911, 912	1-121-937-11 (B)220 50 V	
C913, 914	1-108-251-12 (B)0.1	mylar
C915, 916	1-121-937-11 (B)220 50 V	
C921, 922	1-121-935-11 (B)100 25 V	
C931, 932	1-123-062-11 (B)100 35 V	
C933, 934	1-108-239-12 (A)0.01	mylar
C935 ~938	1-121-935-11 (B)100 25 V	
C951 ~954	1-108-429-12 (B)0.047 200 V	mylar
CT401, 402	1-141-147-XX (B)15 p	trimmer

RESISTORS

All resistors are in Ω . Regular-type $\frac{1}{4}$ W carbon resistors are omitted. Check the schematic diagram for the resistance values. (k = 1000, M = 1000 k)

R1 1-202-719-11 (A)1M $\frac{1}{2}$ W composition
(USA, Canada model)

Note: The circled letters (A to Z) are applicable for the European models only.

<i>Ref. No.</i>	<i>Part No.</i>	<i>Description</i>		
R101	1-211-530-11	(A) 220	¼ W	carbon (nonflammable)
R208	1-211-518-11	(A) 68	¼ W	carbon (nonflammable)
R214	1-211-524-11	(A) 120	¼ W	carbon (nonflammable)
R236	1-202-559-11	(A) 270	½ W	composition (nonflammable)
R237, 242	1-211-522-11	(A) 100	¼ W	carbon (nonflammable)
R314, 364	1-246-486-11	(A) 3.6 k ± 2%	¼ W	carbon (USA, Canada model)
R318, 368	1-246-472-11	(A) 910 ± 2%	¼ W	carbon (USA, Canada model)
R319, 369	1-246-464-11	(A) 430 ± 2%	¼ W	carbon (USA, Canada model)
R322, 372	1-211-522-11	(A) 100	¼ W	carbon (nonflammable) (USA, Canada model)
R401	1-244-891-11	(A) 5.6 k	½ W	carbon (USA, Canada model)
R419, 424	1-211-522-11	(A) 100	¼ W	carbon (nonflammable)
R603	1-202-561-11	(A) 330	½ W	composition (USA, Canada model)
R706, 756	1-211-514-11	(A) 47	¼ W	carbon (nonflammable)
R712, 762, R713, 763	1-211-538-11	(A) 470	¼ W	carbon (nonflammable)
R715, 765	1-202-525-11	(A) 10	½ W	composition
R716, 766	1-202-517-11	(A) 4.7	½ W	composition
R718, 719	1-202-565-11	(A) 470	½ W	composition
R767	1-202-595-11	(A) 8.2 k	½ W	composition
R768, 769	1-202-565-11	(A) 470	½ W	composition
R805	1-211-515-11	(A) 51	¼ W	carbon (nonflammable)
R808	1-202-597-11	(A) 10 k	½ W	composition
R812	1-202-561-11	(A) 330	½ W	composition
R813	1-211-538-11	(A) 470	¼ W	carbon (nonflammable)

<i>Ref. No.</i>	<i>Part No.</i>	<i>Description</i>		
R911, 912	1-217-387-11	(B) 10	¼ W	fusible
R913	1-211-582-11	(A) 4.7	½ W	carbon (nonflammable)
R914	1-213-213-11	(B) 18	1 W	fusible
R915, 916	1-211-515-11	(A) 51	¼ W	carbon (nonflammable)
R921, 922	1-211-530-11	(A) 220	¼ W	carbon (nonflammable)
R931, 932	1-211-945-11	(A) 2.2 k	¼ W	carbon (nonflammable)
R935, 936	1-211-515-11	(A) 51	¼ W	carbon (nonflammable)
RT201	1-224-647-XX	(B) 47 k		adjustable
RT202	1-224-648-XX	(B) 100 k		adjustable
RT203	1-224-644-XX	(B) 4.7 k		adjustable
RT204	1-224-647-XX	(B) 47 k		adjustable
RT205	1-224-646-XX	(C) 22 k		adjustable
RV601, 651	1-224-807-00	(E) 250 k		variable, VOLUME
RV602, 652	1-224-810-00	(D) 10 k		variable, BALANCE
RV603, 653, RV604, 654	1-224-811-00	(D) 50 k		variable, TREBLE, BASS

SWITCHES

S1	1-516-948-00	(G) Rotary, FUNCTION
S2 ~4, 10	1-516-955-00	(F) Pushbutton, 4-key; MONITOR, MONO, FM MUTING (AEP model)
S2 ~4, 10, 11	1-516-956-00	(G) Pushbutton, 5-key; MONITOR, MONO, FM MUTING, DOLBY FM (USA, Canada model)
S5	1-516-685-00	(F) Lever Slide, MUTING
S6	1-516-952-00	(E) Rotary Slide, ACOUSTIC COMP
S7, 8	1-516-946-00	(E) Pushbutton, 2-key; FILTER
S9	1-516-957-00	(E) Rotary Slide, SPEAKER
S12	1-516-628-00	(E) Pushbutton; POWER (AEP model)
	1-516-693-00	(E) Pushbutton; POWER (USA, Canada model)
SE1, 2	1-516-954-00	(B) De-emphasis (AEP model)

FUSES

FI	1-532-349-XX	(B) 4 A (USA, Canada model)
----	--------------	-----------------------------

MOUNTING DIAGRAM – Power Amp, IC, Headphone Jack, Power Supply Circuit Boards –
 – Conductor Side –

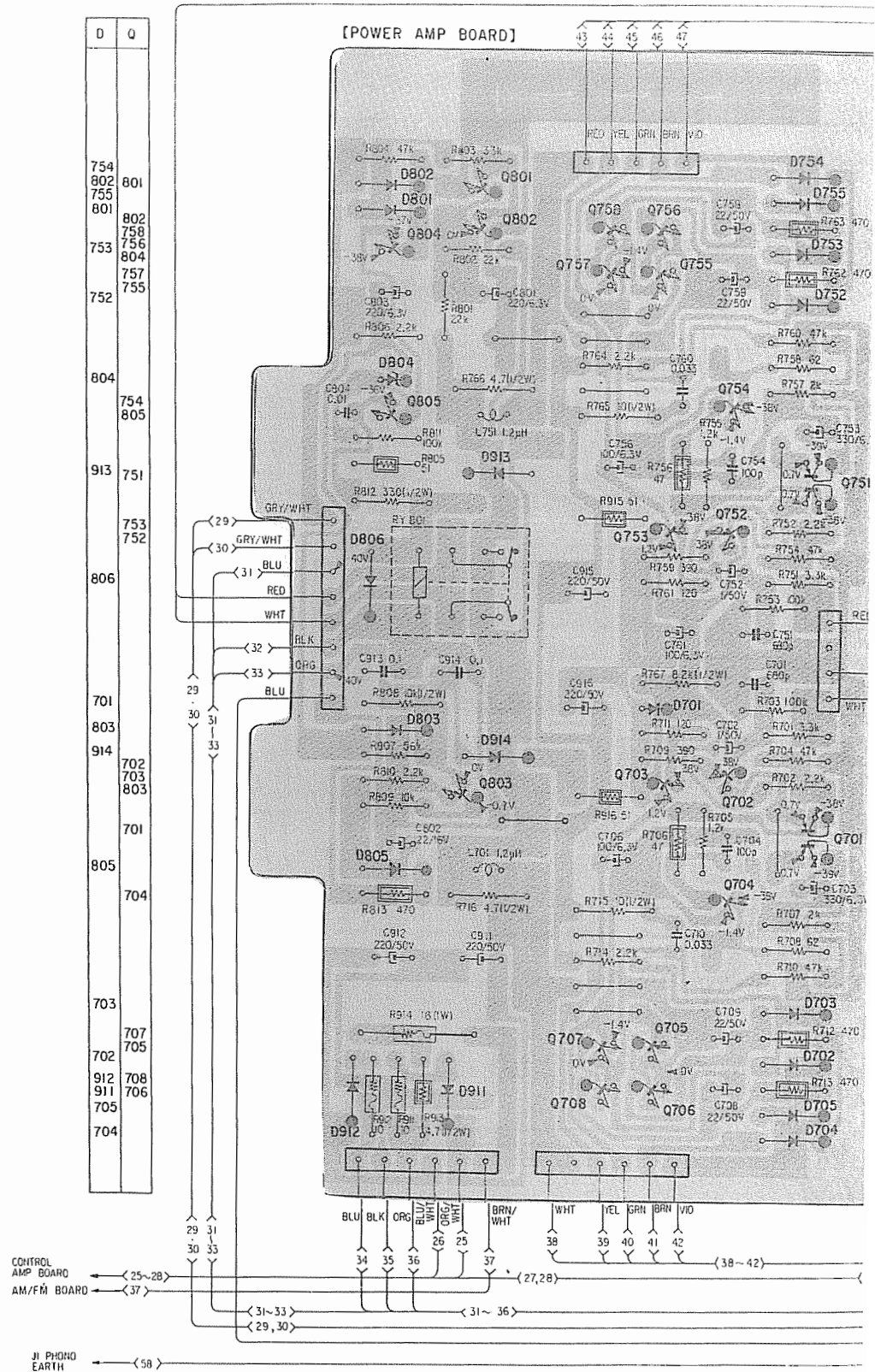

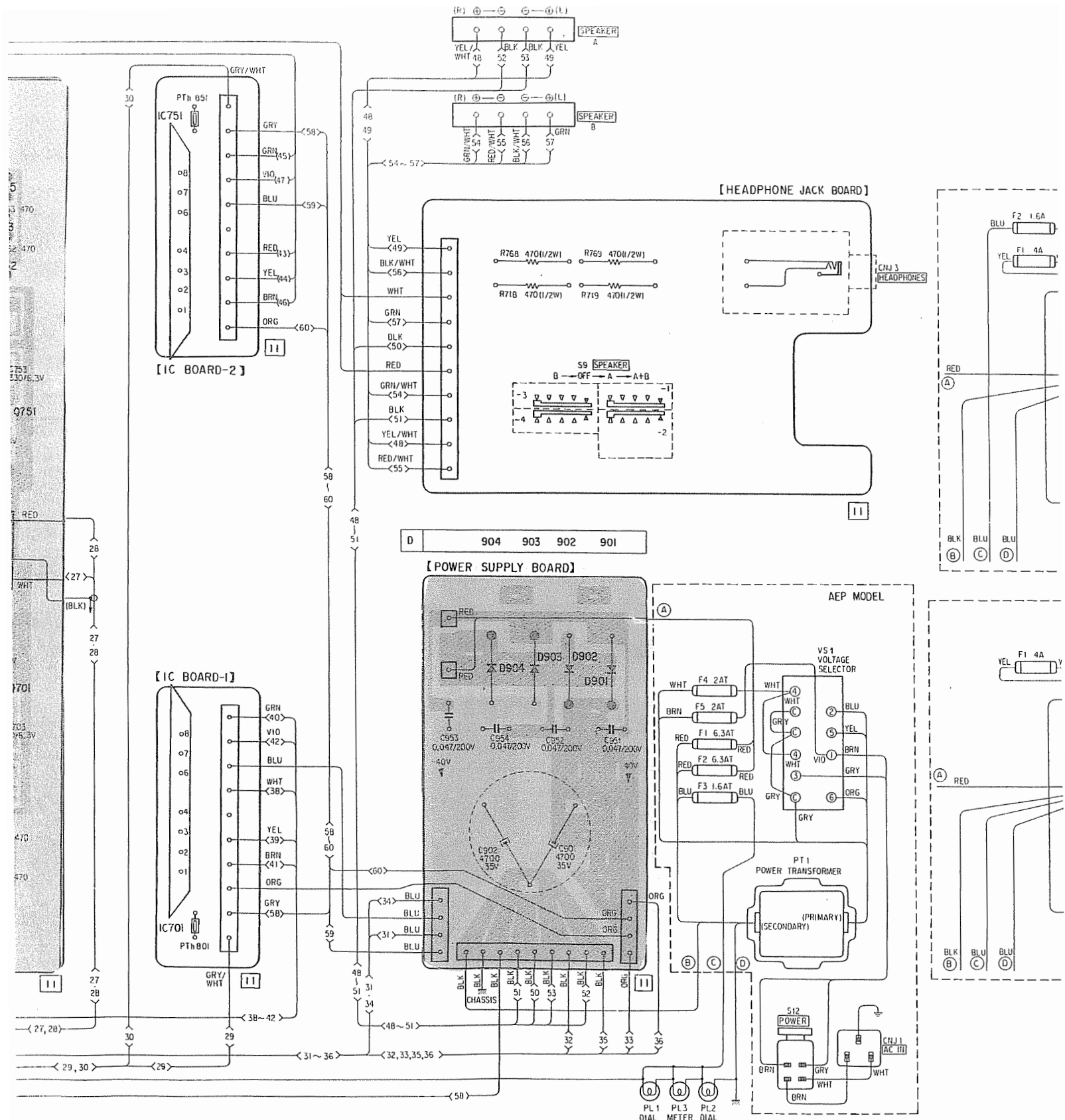

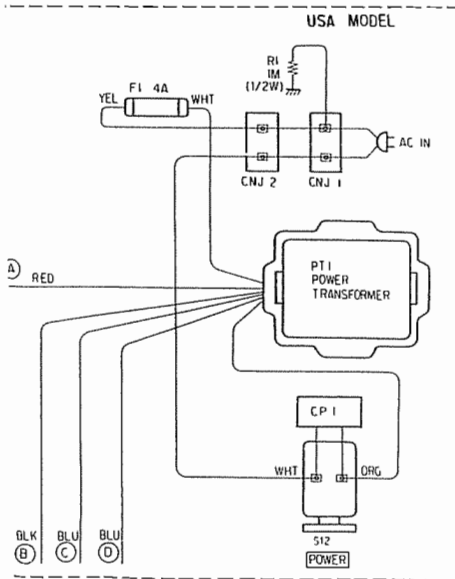
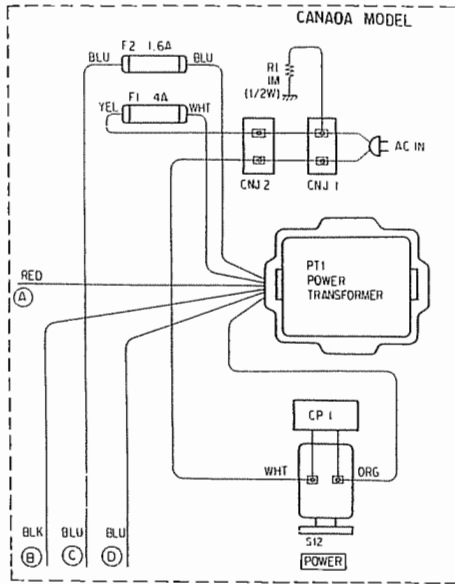

Q701, 751: 2SC705

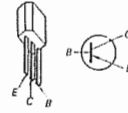

D702 ~ 705
752 ~ 755
801 ~ 803
805, 806 } 1S1555
D911, 912: 10E2

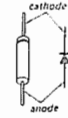

Q703, 753: 2SA896

Q704, 754 } 2SC1811
805

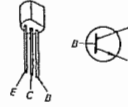

D701: VD1221

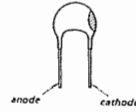

Q705, 708
755, 758 } 2SA735
801 ~ 803

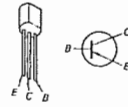

D804: 1T243M

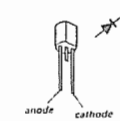

Q706, 707
756, 757 } 2SC1364
804

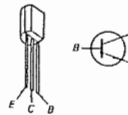

D901 ~ 904: U05E

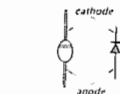

IC701, 751: SS050A

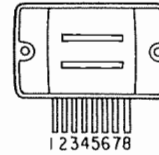

Note:

- B+ pattern
- B- pattern

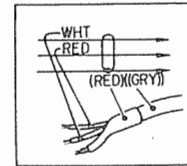

MOUNTING DIAGRAM – Function Switch, AUX Jack, REC/PB Coi
 – Conductor Side –

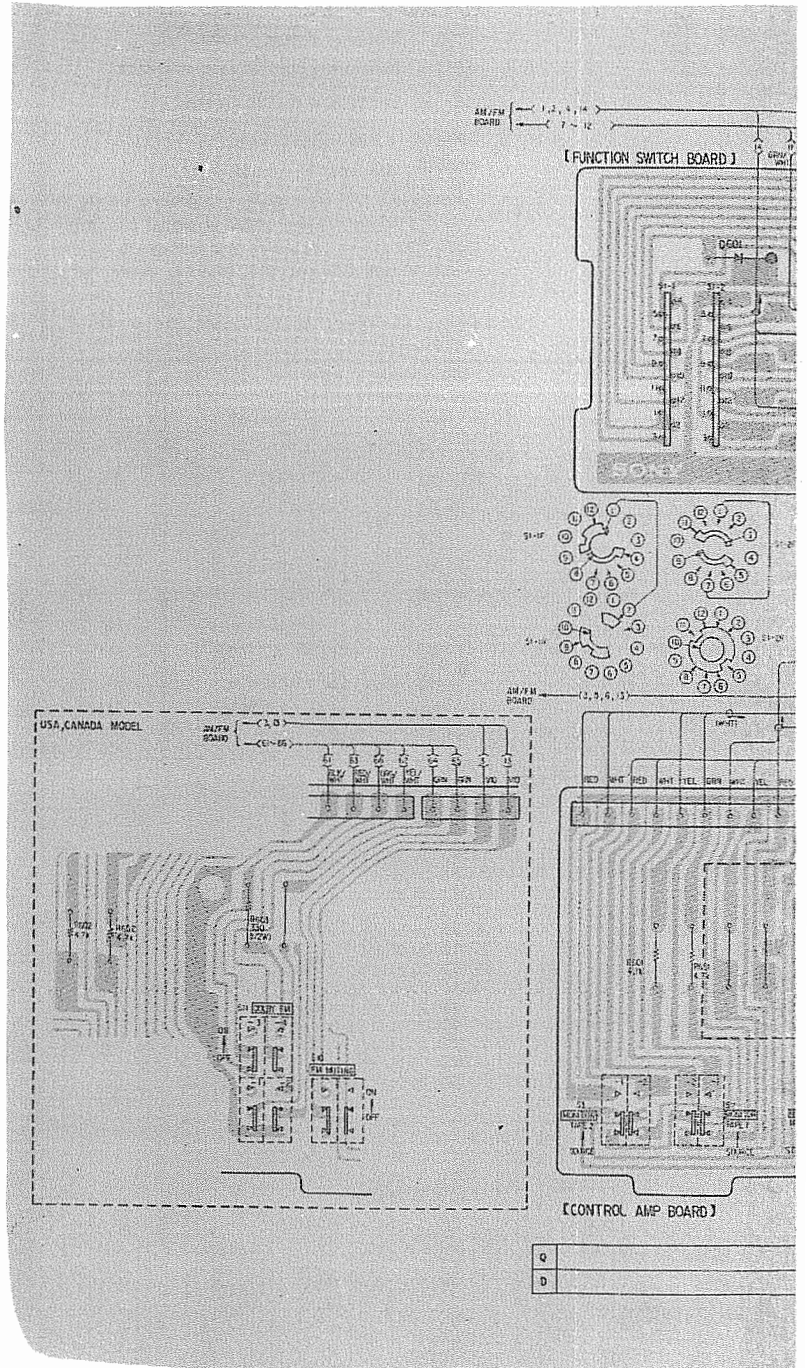

Jack, REC/PB Connector, EQ Amp, Volume Control, Control Amp Circuit Boards —

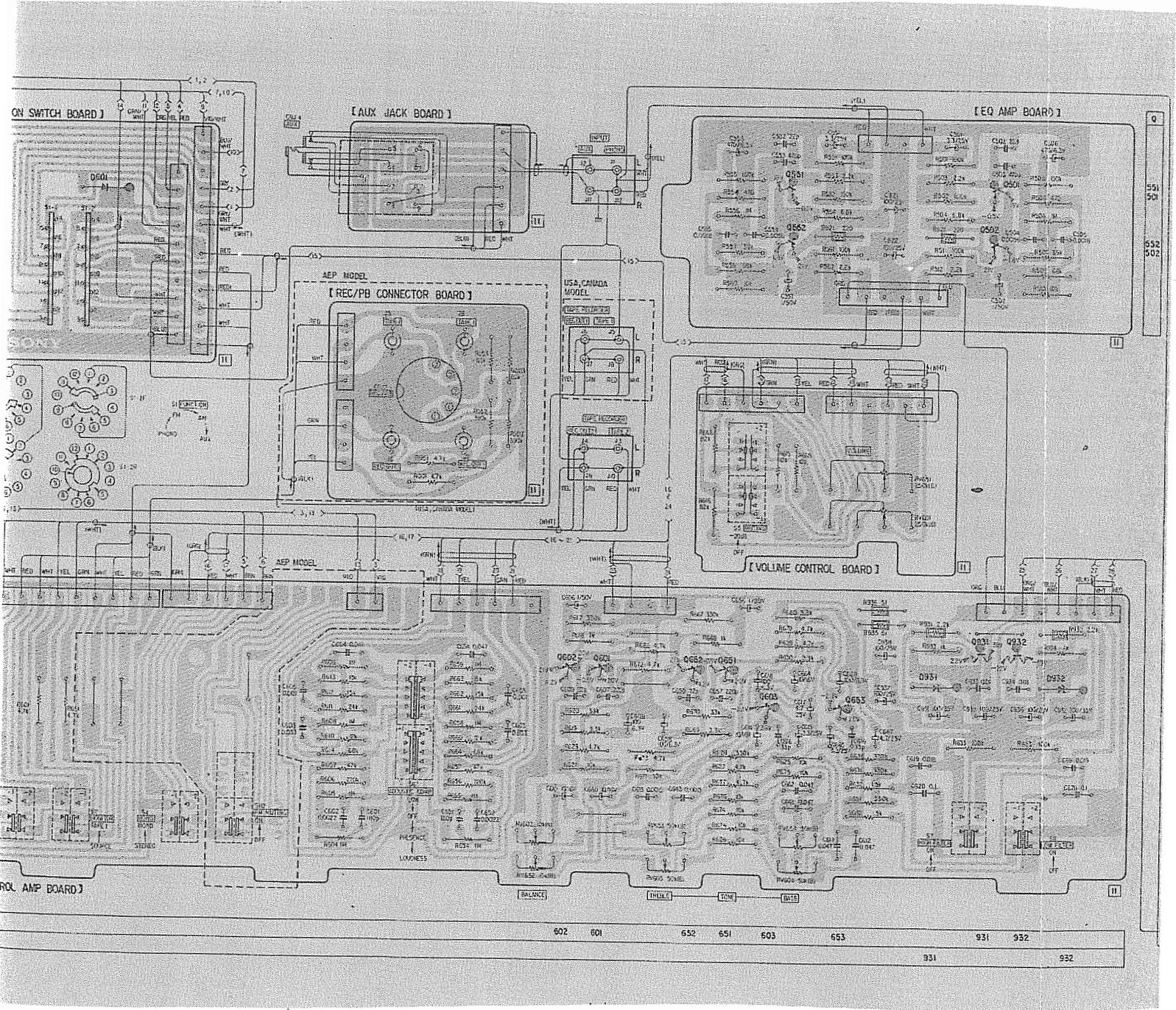

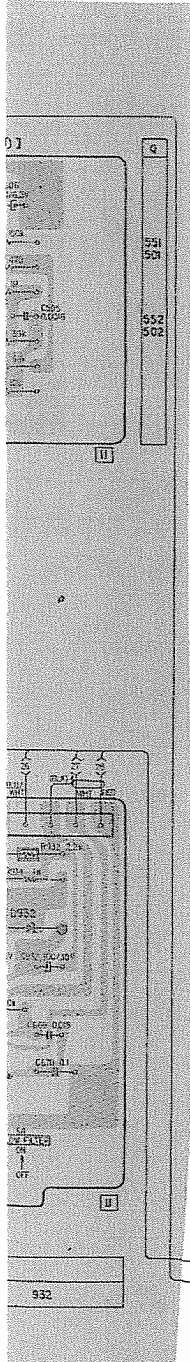

Q501, 551 } 2SC1636
 601, 651 }

Q603, 653: 2SC632A

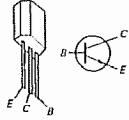

Q502, 552 } 2SA705
 602, 652 }

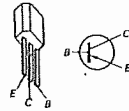

Q931: 2SC1124

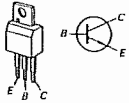

Q932: 2SA706

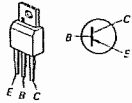

D601: 1S1555

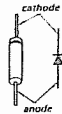

D931, 932: EQA01-21R

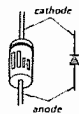

Note:

- : B+ pattern
- : B- pattern

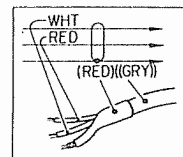

25 ~ 20 POWER AMP BOARD
 (50) POWER SUPPLY BOARD

Sony STR-4800, STR-4800SD

Note: The circled letters (A) to (Z) are applicable for the European models only.

<u>Ref. No.</u>	<u>Part No.</u>	<u>Description</u>
F2	1-532-267-XX	(B) 1.6 A (Canada model)
F1, 2	1-532-325-00	(B) 6.3 AT (AEP model)
F3	1-532-053-00	(B) 1.6 AT (AEP model)
F4, 5	1-532-203-00	(B) 2 AT (AEP model)
JACKS		
CNJ1, 2	1-526-528-00	(D) AC OUTLET (USA, Canada model)
CNJ1	1-509-546-00	(C) Connector, 3-p; AC IN (AEP model)
CNJ2	1-509-549-00	(B) Connector, REC/PB (AEP model)
CNJ3	1-507-454-00	(C) HEADPHONES
CNJ4	1-507-453-00	(C) AUX
J1, 2 J11, 12 J3, 4 J9, 10	1-507-470-00	(C) Phono, 4-p; PHONO, AUX
	1-507-470-00	(C) Phono, 4-p; TAPE 2, REC OUT 2
	1-507-471-00	(C) Phono, 4-p; TAPE 1, REC OUT 1 (AEP model)
J5~8	1-507-470-00	(C) Phono, 4-p; TAPE 1, REC OUT 1 (USA, Canada model)

<u>Ref. No.</u>	<u>Part No.</u>	<u>Description</u>
MISCELLANEOUS		
CP1	1-231-057-31	(B) Encapsulated Component (USA, Canada model)
ME1	1-520-235-00	(H) Meter, SIGNAL
ME2	1-520-236-00	(H) Meter, FM TUNING
PL1~3	1-518-116-00	(B) Lamp, 11 V 360 mA; dial, meter
PL4	1-518-169-XX	(B) Lamp, 4.5 V 40 mA; STEREO
PL5	1-518-169-XX	(B) Lamp, 4.5 V 50 mA, DOLBY FM (USA, Canada model)
RY801	1-515-257-00	(H) Relay
TM1, 2	1-535-057-XX	(E) Terminal Strip, SPEAKER
TM3	1-535-132-00	(B) Terminal, ground
TM4	1-536-469-00	(D) Terminal Strip, ANTENNA
	1-508-690-00	(C) Plug, voltage selector (AEP model)
	1-534-538-XX	(C) Cord, power (USA model)
	1-534-986-XX	(F) Cord, power (Canada model)
	1-536-392-XX	(B) Terminal Strip

CIRCUIT BOARD REMOVAL

TONE Control, AUX Jack and HEADPHONES Jack Circuit Board Removal.

1. Remove the bottom plate (2-3) and front panel (2-4) first.
2. Remove three screws (① - ③) as shown in Fig. 2-5.
After removing the circuit boards from the front subchassis, replace the defective switch or jack.

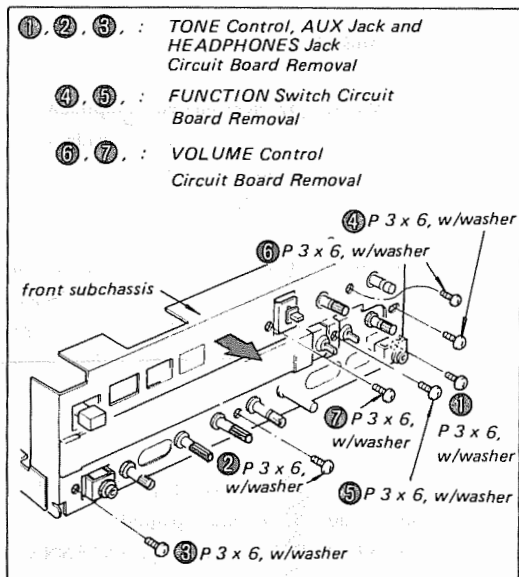

Fig. 2-5.

FUNCTION Switch Circuit Board Removal

1. Remove the front panel (2-4) first.
2. Remove two screws (④, ⑤) as shown in Fig. 2-5.
After removing the circuit board from the front subchassis, replace the defective switch.

VOLUME Control Circuit Board Removal

1. Remove the front panel (2-4) first.
2. Remove two screws (⑥, ⑦) as shown in Fig. 2-5.
After removing the circuit board from the front subchassis, replace the defective control.

POWER AMP and EQ AMP Circuit Board Removal

1. Remove the bottom plate (2-3) first.
2. See Fig. 2-6.

- ①: POWER AMP Circuit Board Removal
 ②: EQ AMP Circuit Board Removal

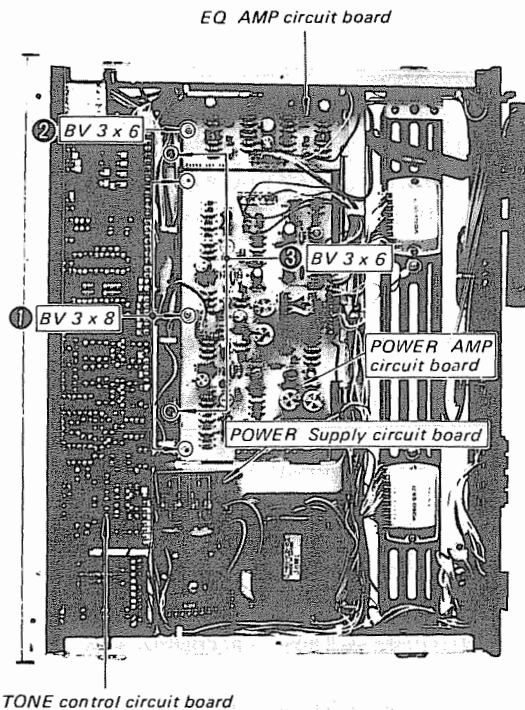

Fig. 2-6.

Replacement of the Components on the Front-End Circuit Board.

1. Remove the bottom plate (2 - 3) first.
2. Remove two BV 3 x 6 screws (②) securing the power amp and EQ amp circuit boards to the shield plate as shown in Fig. 2-6.
3. Remove the shield plate from the chassis.
4. It is possible to unsolder the components on the front-end circuit board.

SCHEMATIC DIAGRAM — Front-End, FM/AM Section —

[FRONT-END BOARD]

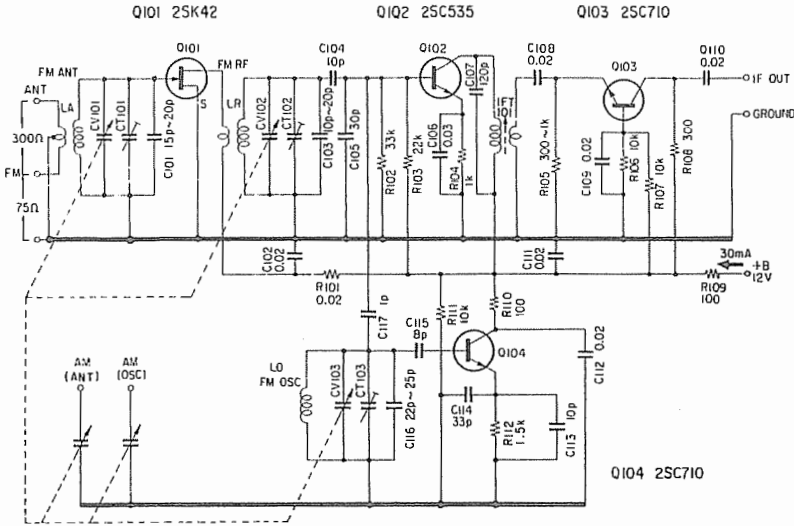

[AM/FM BOARD]

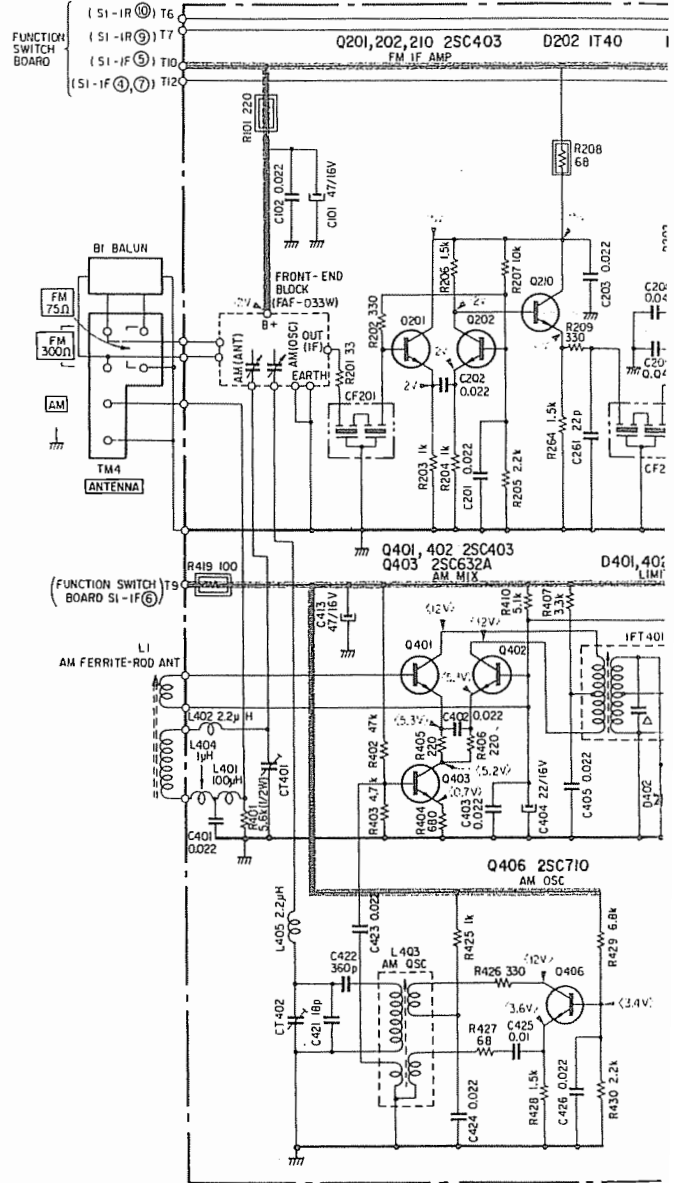

Q101: 2SK42

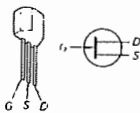

Q102: 2SC535

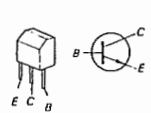

Q103, 104: 2SC710

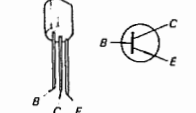

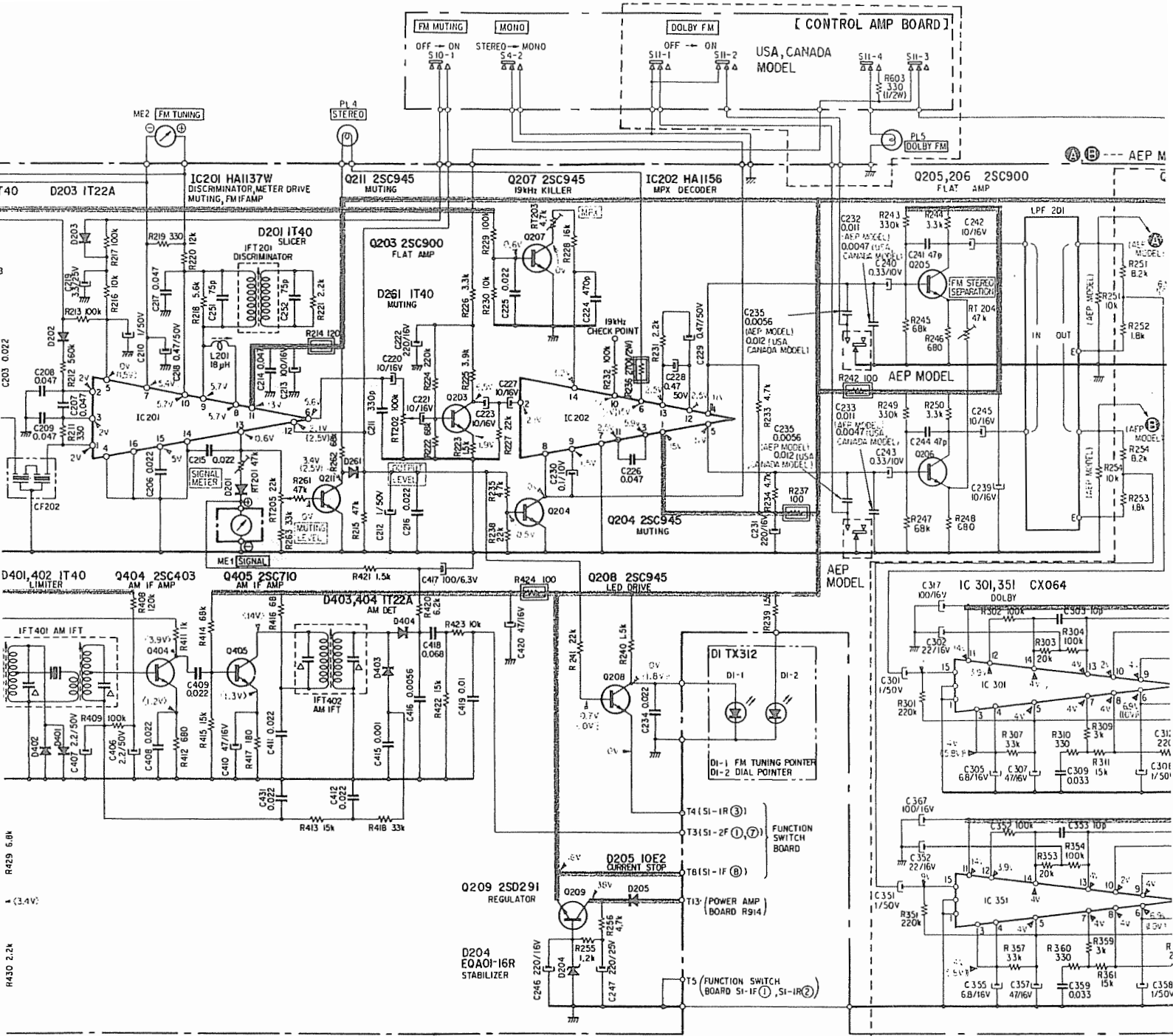

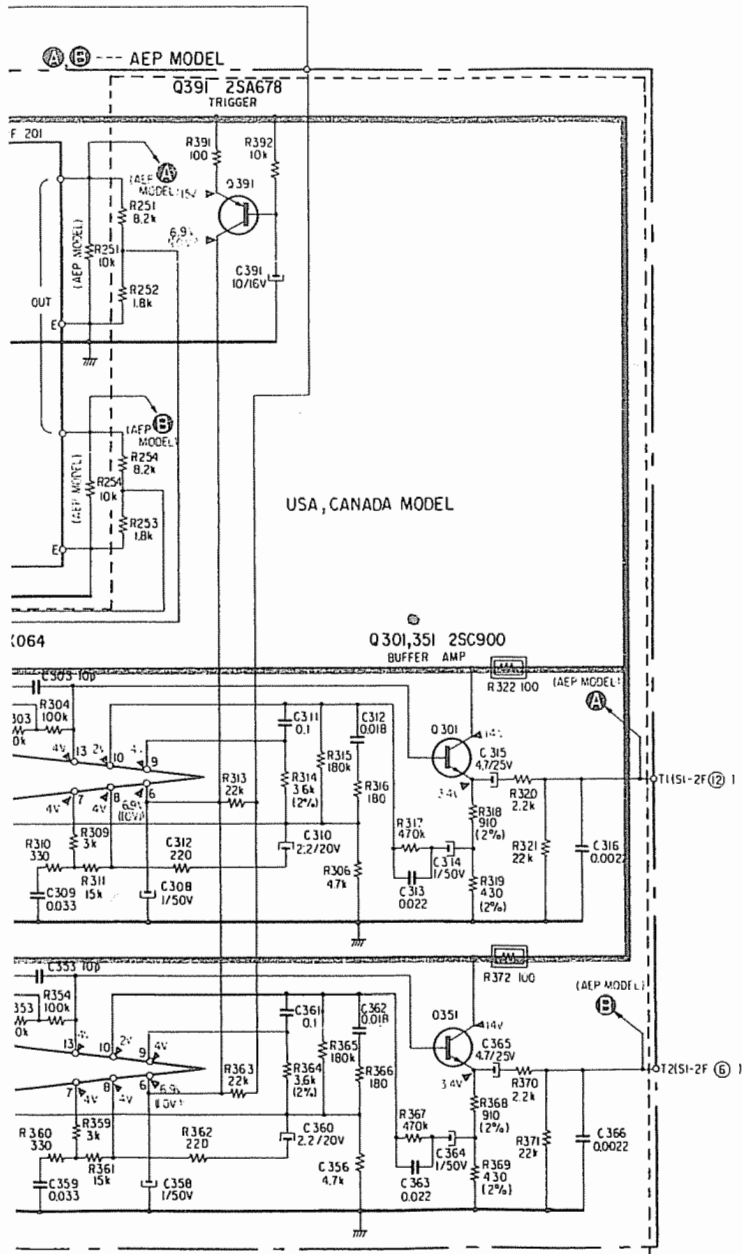

Note:

- All capacitors are in μF unless otherwise noted. 50 or less working volts are omitted except for electrolytic type μF .
- All resistors are in Ω , $\frac{1}{2}\text{W}$, unless otherwise noted. $k = 1,000$ $M = 1,000k$
- \triangle indicates internal components.
- --- indicates chassis ground.
- --- indicates a nonflammable resistor.
- --- indicates B+ circuit.
- Voltage are measured by VOM (20 $k\Omega/v$) in DC with respect to ground unless otherwise noted.
- $\llcorner \triangleright$: FM (monaural or stereo)
- $\{ \}$: FM MUTING (S10) — ON (Detuned in FM)
- $\{\{ \}$: DOLBY FM (S11) — ON (Detuned in FM)
- $[]$: FM STEREO
- $< >$: AM (Detuned)
- no mark: FM (Detuned)
- Voltage variations may be noted due to normal production tolerances.
- Switch Mode:

Ref. No.	Switch	Position
S4	MONO	STEREO
S10	FM MUTING	OFF
S11	DOLBY FM	OFF

SCHMATIC DIAGRAM – Amplifier Section –

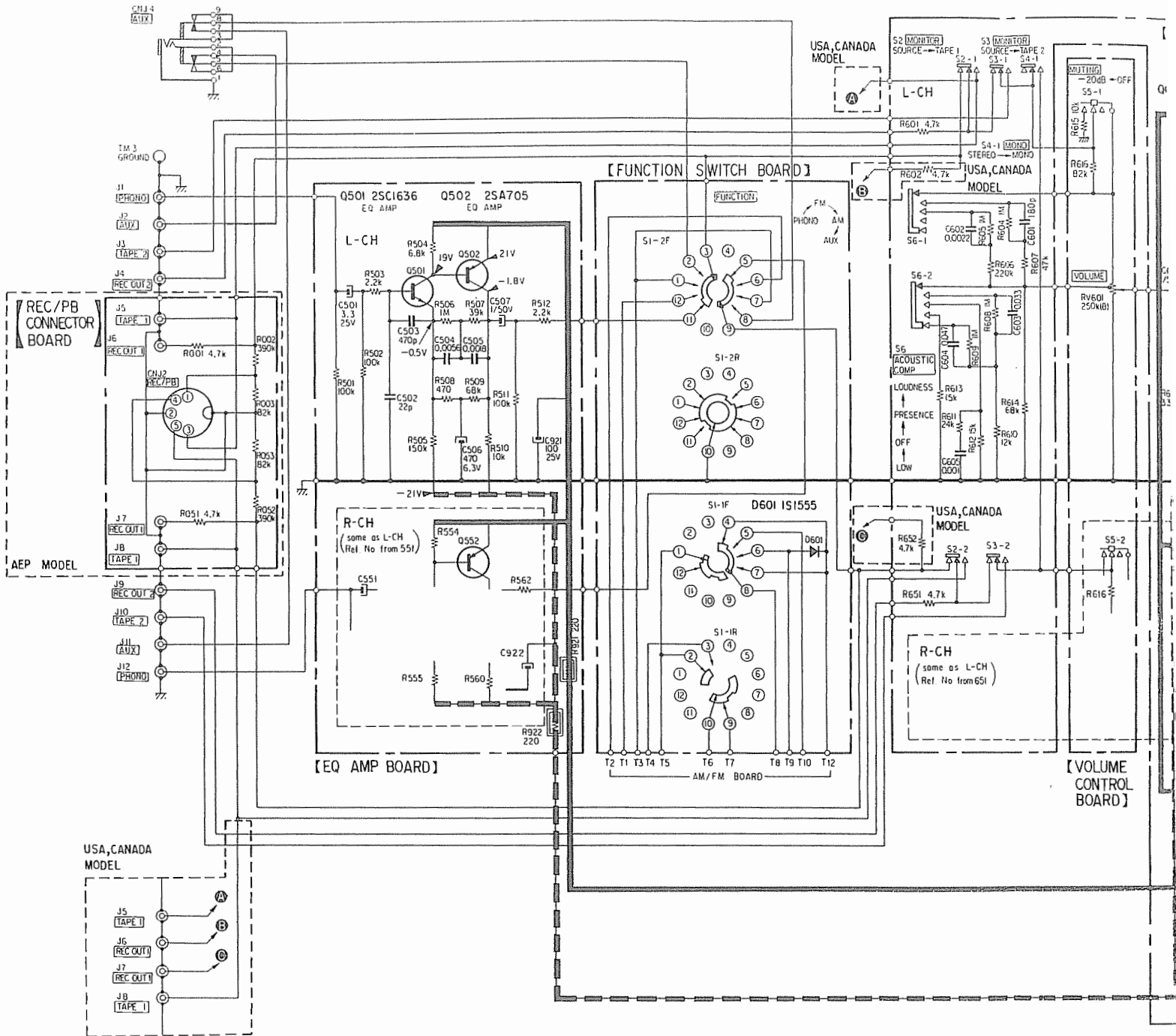

Sony STR-4800, STR-4800SD

[CONTROL AMP BOARD]

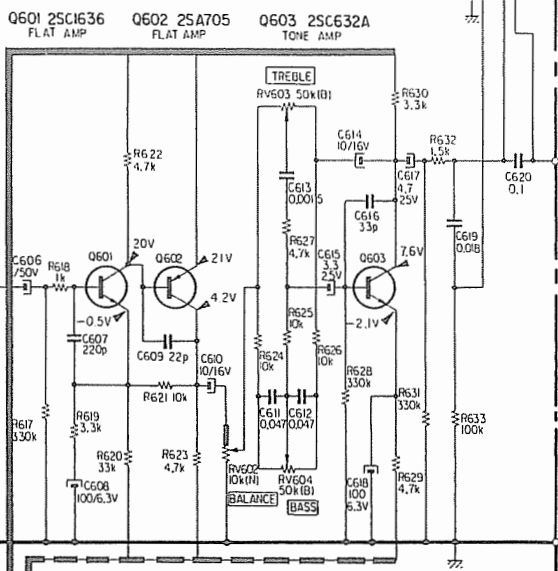

[POWER AMP BOARD]

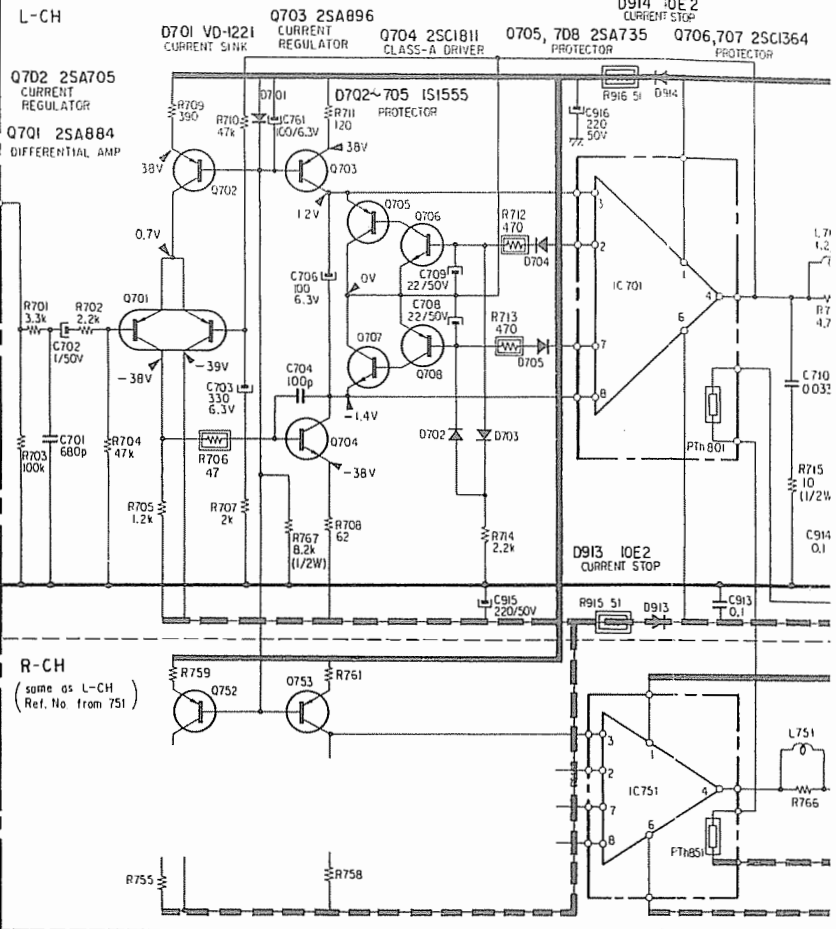

[VOLUME CONTROL BOARD]

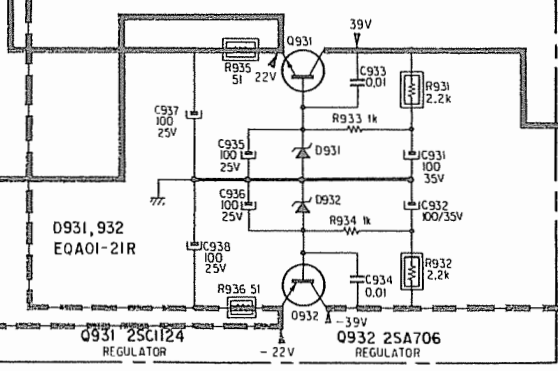

[POWER SUPPLY BOARD]

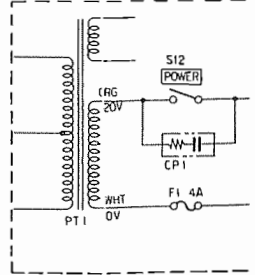
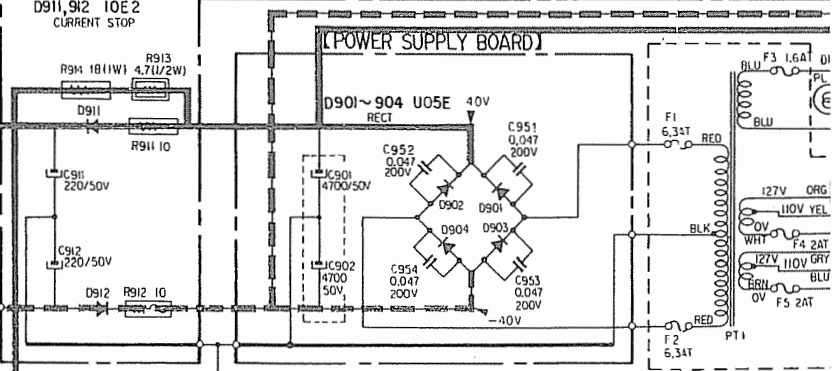

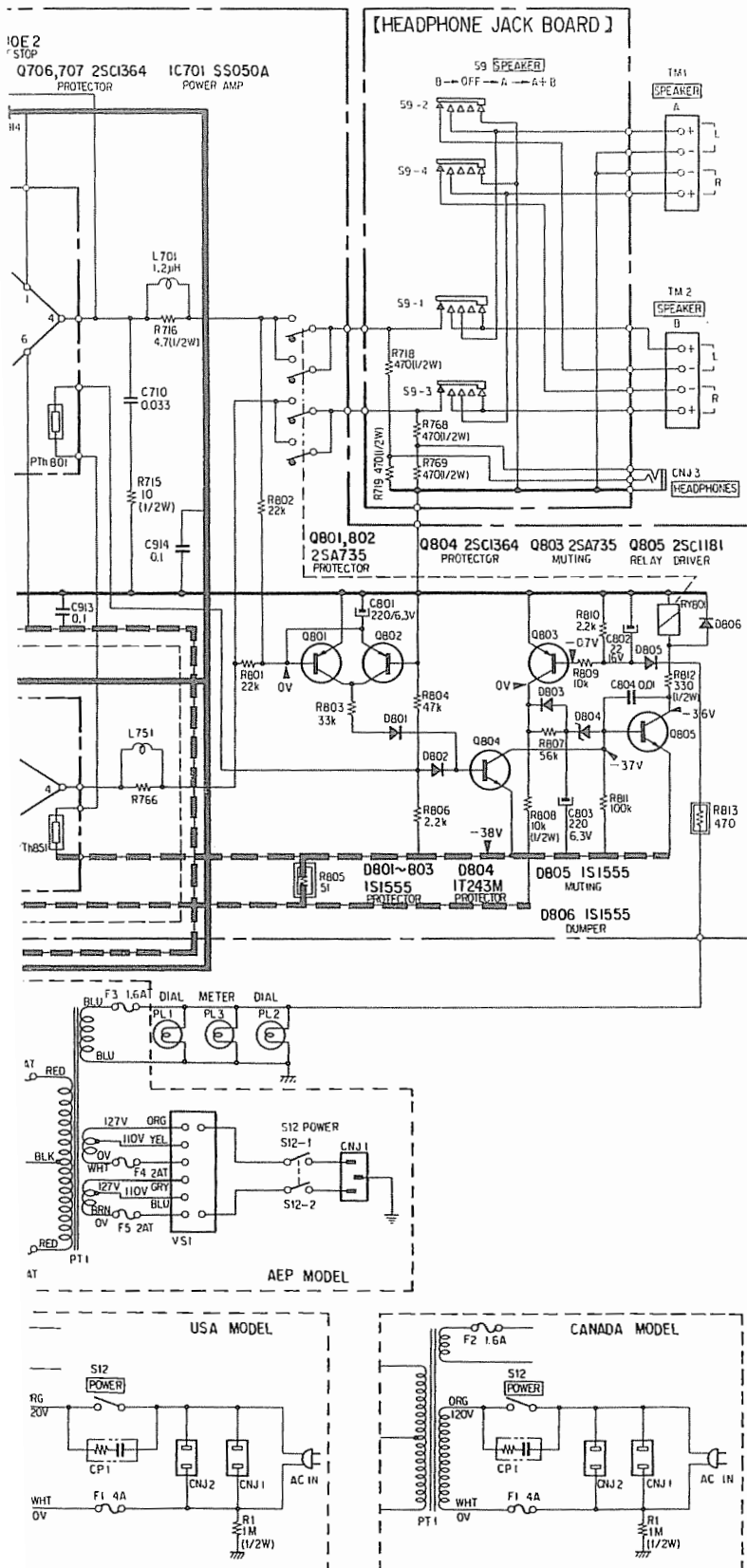

Note:

- All capacitors are in μF unless otherwise noted. 50 or less working volts are omitted except for electrolytic type. $\rho = \mu\mu\text{F}$.
- All resistors are in Ω , $\frac{1}{4} \text{ W}$, unless otherwise noted. $k = 1,000$ $M = 1,000 k$
- indicates chassis ground.
- indicates a nonflammable resistor.
- indicates a fusible resistor.
- indicates B+ circuit.
- indicates B- circuit.
- Voltages are DC with respect to ground unless otherwise noted. Readings taken under no-signal conditions with a VOM (20 $k\Omega/v$). Measure the voltages after the power switch turned ON and 4-6 minutes passed for warm-up the set.
- Voltage variations may be noted due to normal production tolerances.
- Switch Mode:

Ref. No.	Switch	Position
S1	FUNCTION	PHONO
S2	MONITOR	SOURCE
S3	MONITOR	SOURCE
S4	MONO	STEREO
S5	MUTING	OFF
S6	ACOUSTIC COMP	LOW
S7	HIGH FILTER	OFF
S8	LOW FILTER	OFF
S9	SPEAKER	B
S10	FM MUTING	OFF
S12	POWER	OFF