

SONY®

www.hifi-museum.com
FM STEREO/FM-AM RECEIVER

STR-7800SD



Owner's instruction manual

OWNER'S RECORD

For your convenience, record the model number and serial number (you will find them on the rear of your unit) in the space provided below. Please refer to them when you contact your Sony dealer in case of difficulty. This will be a great help to you in getting better and more satisfactory service on your unit.

Model No. STR-7800SD Serial No. _____

Before operating your new Sony receiver, please read this manual completely to become familiar with all its features and capabilities.

Keep this manual handy for future reference.

TABLE OF CONTENTS

Warning	3
Unpacking	3
Precautions	3
System connections	4
Connection diagram	
Connection notes	
Speakers	
Antennas	
Operation	8
Initial operation	
Fm and a-m reception	
Record playing	
Tape playback	
Tape recording	
Tape copy	
Adjusting the stereo balance	
Location and function of controls	10
Use of an external adaptor	12
Care of your equipment	13
Trouble checks	
Cleaning	13
Dolby encoded fm broadcasts	14
Specifications	14
Block diagram	back cover

WARNING

- To prevent fire or shock hazard, do not expose the set to rain or moisture.
- To avoid electrical shock, do not open the cabinet. Refer servicing to qualified personnel only.

UNPACKING

Do not throw away the carton and the associated material; they will come in handy if you ever have to transport or ship the unit. Inspect your unit immediately after unpacking. If any sign of damage is found, consult your local Sony dealer.

When shipping the unit for repair work or to another location, it should be repacked in the original carton and packing material just as it was originally.

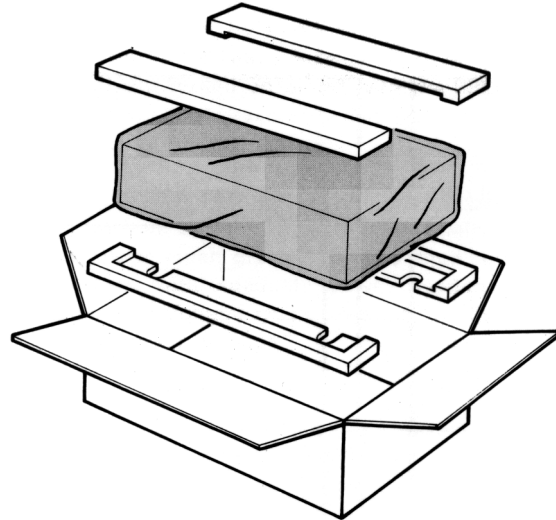

PRECAUTIONS

On safety

- Check that the operating voltage of your unit is identical with the voltage of your local power supply.
- Should any liquid or solid object fall into the cabinet, unplug the unit and have it checked by qualified personnel before operating it any further.
- Unplug the unit from the wall outlet if it is not to be used for an extended period of time. To disconnect the cord, pull it out by grasping the plug. Never pull it out by the cord.

On installation

- Do not install the unit in a location near heat sources such as radiators or air ducts, or in a place subject to direct sunlight, excessive dust, mechanical vibration or shock.
- Good air circulation is essential to prevent internal heat build-up in the unit. Place the unit in a location with adequate air circulation. Do not place the unit on soft surfaces, such as a rug, that would block the ventilation holes on the bottom.
- Do not place anything on top of the cabinet. The top ventilation holes must be unobstructed for the proper operation of the unit and to prolong the life of its components.
- Do allow more than 15 cm (6 inches) of space behind the unit so that the position of the built-in ferrite-bar antenna can be adjusted.

On operation

- When the unit is not in use, turn the power off to conserve energy and to extend the useful life of your unit.

Speaker phasing

One of the most important requirements for good stereo reproduction is correct speaker phasing (all speaker cones move in the same direction when similarly energized). For correct speaker phasing, all speakers must be connected in the same way i.e. all \oplus terminals of speakers should be connected to \oplus terminals of the receiver, and \ominus to \ominus . If one connection is reversed, all others must also be changed. Otherwise the speaker phasing becomes reversed so that the bass tones seem to be missing and the position of the instruments becomes obscure.

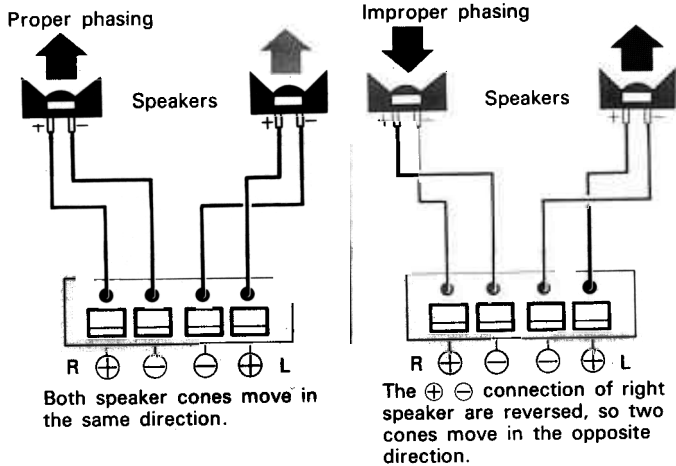

For a simple speaker phasing check, depress the MONO switch and set the BALANCE control at the center position. Listen to a program source which contains prominent bass tones. Reverse the \oplus \ominus connection of one speaker at the receiver or speaker, whichever is more convenient. If the bass response is improved, the original connection was incorrect. If the bass response is decreased, the original connection was correct. This check is more positive if it is possible to bring the speakers close together, facing each other about 30 cm (1 foot) apart.

Speaker placement

Here are a few suggestions for speaker placement that will assist you in obtaining an installation with satisfactory stereo sound.

Normally, the speakers are placed on the floor against the narrower wall of a room. The bass sounds can then be increased by moving the speakers toward the corners, or decreased by raising the speakers off the floor on suitable pedestals, and/or moving them away from the wall a moderate distance. If the speakers are positioned above the floor, do not place them higher than ear-level while seated, since this produces an unnatural effect.

However, moving the speakers toward the corners in a large room, while increasing the bass, results in a "hole-in-the-middle" effect which can be partially counteracted by angling the front of the speakers toward the center of the room.

The speakers should be nearly equidistant from the center of the selected wall, and spaced 2 - 3 meters (6 - 10 feet) apart as illustrated.

Place the right and left speakers in similar acoustic environments, otherwise you will obtain unbalanced sound. For example, placing one speaker near an open door or archway will decrease the apparent bass from that speaker.

Best sound is usually obtained in a room with carpeting on the floor, and having heavy draperies and upholstered furniture. Since each room has its own individual acoustic characteristics, which are a function of its size, construction and furnishings, some experimentation with speaker placement is generally necessary before the correct balance of stereo image and bass response is obtained. This will be time well spent, resulting in your enjoyment of the maximum capabilities of your music system.

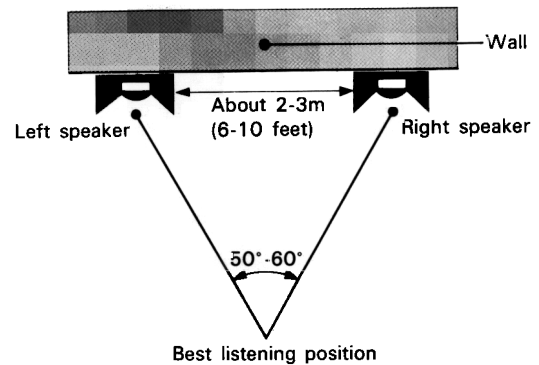

ANTENNAS

Good fm reception depends not only on the receiver sensitivity but on the quality of the received signals. This is determined by the signal strength, the presence of multipath signal and the geographic location of the desired fm stations. To get the best from your receiver, use an antenna suited to your location. Until you install a suitable one, the supplied ribbon antenna may be useful.

In a strong signal area, the familiar "rabbit-ear" antenna is simple to install and is usually suitable for fm reception, since it can be adjusted easily for best signal pickup. If there are any high structures nearby, and evidence of strong multipath reception is present, use a highly-directional rotatable outdoor antenna.

If you wish to receive not only the local stations that an indoor antenna pulls in, but to reach out into areas where there may be program more to your taste, use a high-gain directional outdoor fm antenna properly installed with a rotator.

Ribbon dipole and rabbit-ear antennas pick up signals from both front and rear equally well.



Dipole antenna with reflector has increased sensitivity to front signals and reduced sensitivity to rear signals.

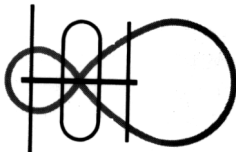

Multi-element type has narrower pickup pattern with high frontal sensitivity and superior rejection of rear signals.

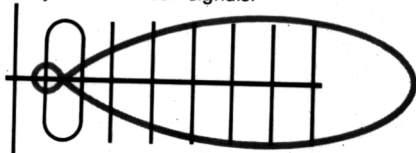

FM antenna connection

The receiver accepts 300-ohm twin lead, either the standard or shielded type, and 75-ohm coaxial cable. Standard 300-ohm twin lead will be adequate for most installations. However in cases where local noise or multipath pickup on the transmission line causes interference, a shielded type must be used. In locations where ignition noise is severe, the coaxial cable is recommended. Be careful not to run the fm antenna lead adjacent to the a-m ferrite-bar antenna.

To avoid excessive loss of signal strength and to minimize undesired pickup on the line, observe the following precautions.

- Use commercially-available stand-off insulators to route the lead over the roof, outer wall, etc.
- Keep the lead as short as possible and avoid long horizontal runs.
- Cut off the unused portion of the lead at the receiver input, rather than folding or bunching it together.

300-ohm twin lead connection

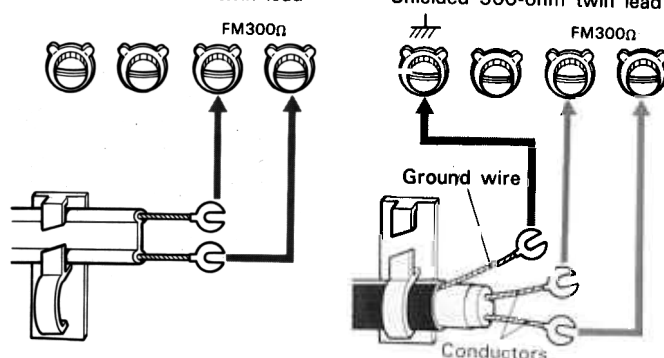

75-ohm coaxial cable connection

- ① Cut and remove the outer covering, shield braid, inner covering as follows, and fold back most of the shield braid. Be careful not to damage the center conductor.

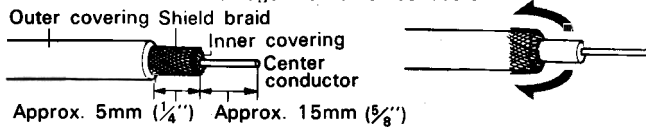

If the center conductor is a stranded type, twist the strands tightly together.

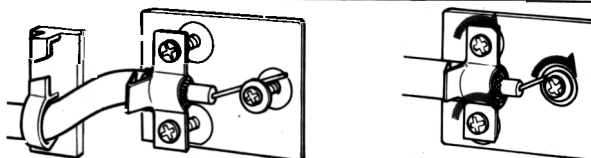

- ② Loosen the screws on the FM 75Ω ANTENNA plate and terminal. Pass the cable under the plate, wind the center conductor round the terminal of the FM 75Ω ANTENNA and tighten screws and terminal.

Multipath reception

The most important factor affecting fm signal quality is multipath reception. Multipath is caused by signal reflections from hills or structures that reach the receiving antenna perceptibly later in time. Particularly with fm stereo, multipath can cause severe distortion and complete loss of channel separation. The effects of a multipath condition appear as high-frequency noise and distortion, particularly noticeable in music systems with extended response. The effects of multipath reception can be avoided to a great extent by using shielded twin lead, and a good directional antenna that is correctly oriented. To help eliminate the effects of multipath by antenna readjustment, the receiver employs a visual read-out of the received strength of the multipath signal.

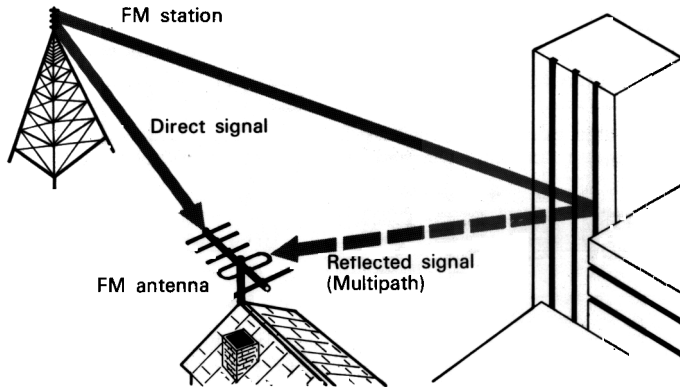

FM antenna orientation

For the highest quality reception, once the antenna has been installed, it should be adjusted to furnish a maximum of signal strength and a minimum multipath component. This can be readily done if either a "rabbit-ear" or motor-driven antenna is used. Adjustment is facilitated by the use of the SIGNAL MULTIPATH meter. Normally this meter gives a visual indication of the station signal strength. However, when the MULTIPATH switch is pressed, the magnitude of the station multipath component is visually indicated. The desired objective of maximum signal and minimum multipath can be quickly and easily accomplished by adjusting first for maximum signal strength. Then depress the MULTIPATH switch and rotate the antenna for a minimum multipath indication on the meter. Now recheck to see if the signal strength is sufficient for lowest noise reception. In most cases, this procedure for finding the optimum signal/multipath ratio should only take a few seconds.

If your favorite stations lie in different directions, this procedure should be accomplished at each change of station. When a fixed position antenna is used, vary the location and direction until an overall satisfactory position is found before making the installation permanent.

In locations where ignition noise is severe, the antenna should be located as far away from the highway as possible.

AM antenna connection

In most areas, the built-in ferrite-bar antenna will provide satisfactory a-m reception. Position the antenna on the rear panel as shown for best reception.



In difficult reception areas, it may be necessary to connect a length of insulated wire 5 - 15 meters (20 - 50 feet) long to the AM ANTENNA terminal. Extend this out of doors if possible, keeping the greater portion horizontal. A-m signal strength is indicated on the SIGNAL MULTIPATH meter; the stronger the signal, the greater the deflection to the right.

OPERATION

INITIAL OPERATION

Once your new receiver is in operation as part of your high-fidelity music system, you will find that most of its controls do not require adjustment at each use. If the controls are set as indicated in the illustration, it will only be necessary to select your program source and adjust the volume to your requirements.

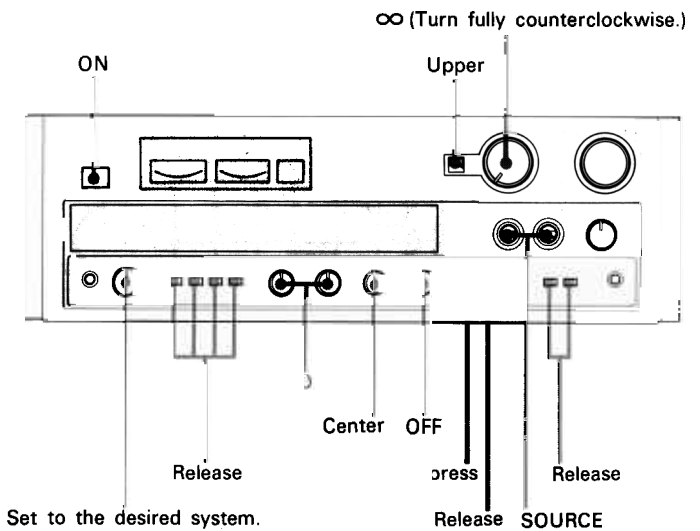

NOTES

●A simple operating habit is worth developing—lower the volume each time you turn on or shut down your system, and there is no possibility of yourself or someone else "blasting" or injuring the speakers when it is turned on again.

● The filters, tone controls and acoustic compensator will adjust the tone quality which may be influenced by room acoustics, speaker characteristics, etc. Use these controls to adjust the tone to your preference. The manipulation of the tone control section does not interrupt the signal path in the receiver. However its overuse may adversely affect receiver tone quality.

FM AND AM RECEPTION

- 1 For fm reception, set the FUNCTION selector to FM. To properly receive a Dolby encoded fm program, depress the DOLBY FM switch.
- For a-m reception, set the FUNCTION selector to AM.
- 2 Tune in the desired station with the TUNING knob.
- 3 Adjust the volume and tone quality to your preference.

The correct tuning of the desired fm station is shown by the SIGNAL MULTIPATH and FM TUNING meters. When receiving an fm signal, the upper half of the dial indicator will light up, and the best tuning point is shown by the maximum deflection to the right of the SIGNAL MULTIPATH meter and the center position of the FM TUNING meter. On a-m reception, the whole dial indicator will light up, and the correct tuning point is shown by the maximum deflection to right of the SIGNAL MULTIPATH meter.

NOTES

- To tune in very weak fm stations, lower the volume and release the FM MUTING switch.
- Be sure to release the DOLBY FM switch when receiving non-Dolby encoded fm programs.
- When fm stereo signals are noisy, depress the MONO switch for the best possible signal under noise conditions.

RECORD PLAYING

- 1 Set the FUNCTION selector to PHONO 1 for the disc program connected to the PHONO 1 jacks, or to PHONO 2 for the disc program connected to the PHONO 2 jacks.
- 2 Play the record.
- 3 Adjust the volume and tone quality to your preference.

TAPE PLAYBACK

- 1 Set the MONITOR selector to TAPE 1 for the tape program connected to the TAPE 1 jacks, or to TAPE 2 for the tape program connected to the TAPE 2 jacks.
- 2 Start the tape playback.
- 3 Adjust the volume and tone quality to your preference.

TAPE RECORDING

- 1 Select the program to be recorded with the FUNCTION selector.
- 2 Adjust the recording level at the recorder and start it in record mode.
- 3 Play the desired program.

NOTES

- The VOLUME, BALANCE, TONE controls, FILTER switches and ACOUSTIC COMP selector have no effect upon the recording.
- You can make two recordings simultaneously by using two tape recorders.
- When using a three-head recorder, you can monitor the recording results by setting the MONITOR selector to TAPE 1 or TAPE 2. In this case, the recorder should be connected to the TAPE and REC OUT jacks, and its monitor switch should be set to TAPE position.

TAPE COPY

You can copy a tape program from one tape recorder to another by positioning the TAPE COPY selector to TAPE 2→1 or TAPE 1→2, while listening to the program source selected with the FUNCTION selector.

- 1 Set the TAPE COPY selector to TAPE 1→2 for the copy from tape recorder 1 to 2.
- 2 Adjust the recording level of tape recorder 2, and start it in record mode.
- 3 Start the playback of tape recorder 1. The copy will begin.

In the same way, you can copy a tape from tape recorder 2 to 1.

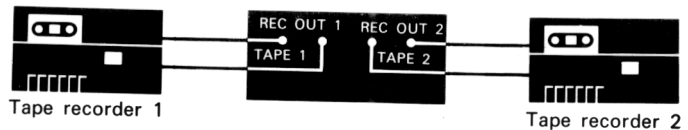

ADJUSTING THE STEREO BALANCE

The feeling of direction and depth that stereophonic sound produces is greatly reduced if the levels of both channels are not balanced. The acoustic balance is influenced by the speaker locations and the room acoustics. Adjust the stereo balance as follows.

- 1 Reproduce a program with a normal listening level.
- 2 Depress the MONO switch.
- 3 Adjust the BALANCE control so that the sound image is centered between the right and left speakers.
- 4 Release the MONO switch.

LOCATION AND FUNCTION OF CONTROLS

www.hifi-museum.com

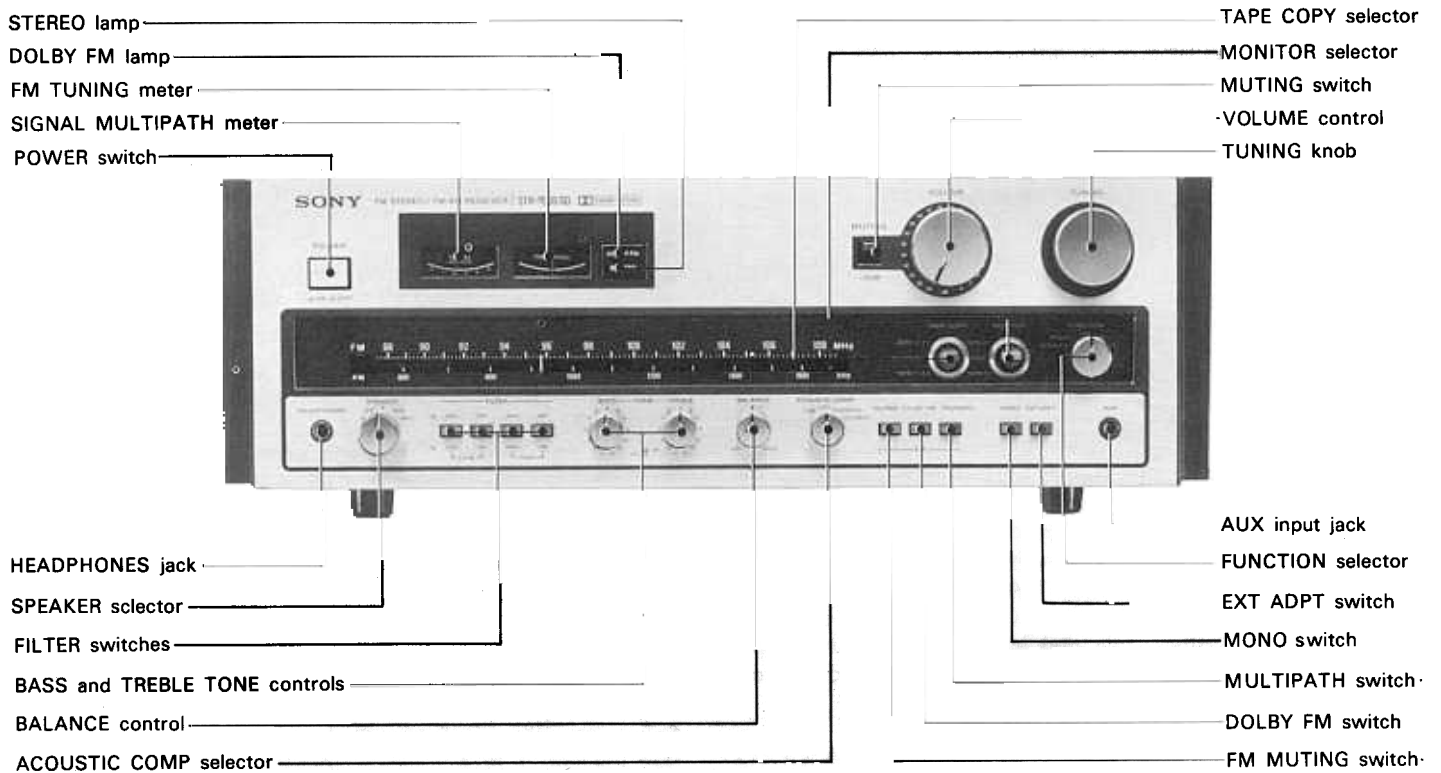

POWER switch

Depress it to apply power to the receiver. The dial will light. Depressing it again will turn off the power.

SIGNAL MULTIPATH meter

This is a dual-function meter which normally indicates the signal strength of fm and a-m broadcast stations. Relative strength of received signals is shown by the amount of pointer deflection. The maximum pointer deflection to the right means best tuning of the station. If the pointer always reads 0-1, the signal level is too weak for full performance. In this case, adjust the antenna.



Good antenna input



Weak antenna input

However, on fm stations, by pressing the MULTIPATH switch, the magnitude of the multipath component is indicated by the degree of meter deflection. If this deflection is substantial, perceptible distortion will be present, and should be removed by readjusting the antenna.



Adjust the antenna direction until the meter reads "0"

FM TUNING meter

While receiving fm programs, this meter acts as a center-of-channel indicator; correct tuning is indicated by a center reading. When the dial indicator comes near the station, the meter pointer will swing either to the left or right, and the pointer will return to the center position at the channel center of the selected station as the correct tuning point is reached. Detuning from the center point will also cause the pointer to move to the right or left, and it will return to the center again when detuned completely.



STEREO lamp

This lamp will light when an fm stereo program of sufficient signal strength is tuned in with the MONO switch released.

DOLBY FM lamp

This lamp will light when the DOLBY FM switch is depressed.

MUTING switch

Normally keep this switch at the upper position.

When this switch is set to -20 dB, overall listening sound level is reduced by 20 dB. This feature is useful when you lower the tonearm onto the disc or when you answer the telephone. When setting it back afterwards, you can restore exactly the same listening level as before.

VOLUME control

This precisely matched attenuator control regulates the overall sound level. The ∞ position provides full attenuation (no sound) and clockwise rotation increases the volume. Note that the "0" indication (full clockwise position) means that the volume control provides zero attenuation (full gain amplification).

TUNING knob

Selects the desired fm or a-m station.

TAPE COPY selector

By positioning this selector to TAPE 2→1 or TAPE 1→2, you can dub from one tape recorder to another, while still listening to the program source selected with the FUNCTION selector.

TAPE 2→1: for dubbing from tape recorder 2 (for playback) to tape recorder 1 (for recording).

SOURCE: for normal operation, keep the selector at this position. The program selected with the FUNCTION selector is then applied to the REC OUT 1 and 2 jacks which allows you to record onto two tape recorders simultaneously.

TAPE 1→2: for dubbing from tape recorder 1 (for playback) to tape recorder 2 (for recording).

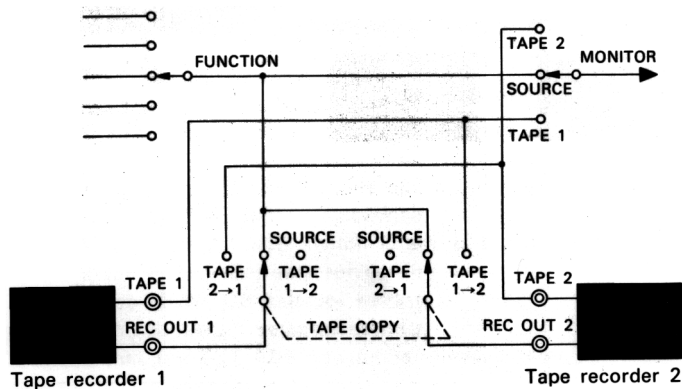

MONITOR selector

TAPE 2: for playback of taped program connected to the TAPE 2 jacks.

SOURCE: for all program sources except for the tape.

TAPE 1: for playback of tape program connected to the TAPE 1 jacks.

FUNCTION selector

Selects the desired program source.

PHONO 2: for disc program connected to the PHONO 2 jacks.

PHONO 1: for disc program connected to the PHONO 1 jacks.

FM: for fm reception.

AM: for a-m reception.

AUX: for an auxiliary program connected to the AUX input jacks.

HEADPHONES jack

This accepts headphones with the impedance from 8 ohms to 10,000 ohms. For private listening, merely turn the SPEAKER selector to OFF.

SPEAKER selector

Selects the desired speakers.

C: to drive the speakers connected to the SPEAKER C terminals.

B: to drive the speakers connected to the SPEAKER B terminals.

OFF: to switch off all speakers.

A: to drive the speakers connected to the SPEAKER A terminals.

A+B: to drive the speakers connected to the SPEAKER A and B terminals simultaneously.

A+C: to drive the speakers connected to the SPEAKER A and C terminals simultaneously.

(Be sure that there are speakers connected to both SPEAKER A and B, or A and C terminals respectively when the [A+B] or [A+C] position is used. Otherwise no sound will be heard because the A and B, or A and C terminals are internally connected in series for such multiple operation.)

FILTER switches

The purpose of the HIGH and LOW filters is to reduce the level of unwanted noise components in the reproduced program material.

With the associated ON/OFF switch depressed to ON, the HIGH FILTER reduced the response at the rate of 6 dB per octave above 5 kHz (switch released) or 10 kHz (switch depressed).

With the associated ON/OFF switch depressed to ON, the LOW FILTER reduces the response at the rate of 6 dB per octave below 50 Hz (switch released) or 25 kHz (switch depressed).

Employ the filters judiciously with troublesome program sources because the wanted signals may be reduced as well as unwanted noise.

BASS and TREBLE TONE controls

These controls are useful for compensating for any deficiency in your speaker system, listening room acoustics, improperly equalized program source material, and so forth. The BASS control regulates the tone in the low-frequency range, and the TREBLE control in the high-frequency range. Clockwise rotation increases response, counterclockwise rotation decreases it, and the center click position provides a flat response. Concentric knobs control the right and left channels simultaneously or independently (outer knob for right and inner for left).

BALANCE control

This regulates the sound balance between right and left channels for optimum stereo effect. Clockwise rotation (to RIGHT) decreases the left-channel sound, and counterclockwise rotation (to LEFT) decreases the right-channel sound.

Normally set the control to the center click position.

ACOUSTIC COMP selector

This may correct some acoustic problems presented by the speaker system used or the listening room characteristics. Normally set this switch at OFF.

LOW: This boosts the low-frequency response if your speaker system is deficient in bass.

OFF: Acoustic compensator circuit is bypassed.

USE OF AN EXTERNAL ADAPTOR

PRESENCE: When reproducing a vocal program (especially female vocal), set the switch to this position. A mid-range booster network works to emphasize the impression of the vocalist.

LOUDNESS: Human ears are less sensitive in their response to very low and very high frequency sound at low volume levels. This loudness control compensates for this characteristic of the ear, and provides an apparently uniform response at such low volume levels. The effects of this control gradually decrease as the volume is increased.

FM MUTING switch

Normally keep this switch depressed to eliminate fm interstation noise while tuning from station to station. Very weak stations are also muted along with the noise, and must be tuned in with the switch released. In this case, keep the volume down to avoid speaker damage caused by the interstation noise.

DOLBY FM switch*

Depress this switch when receiving Dolby encoded fm programs. The DOLBY FM lamp will light. Be sure to release this switch for the proper reception of most present fm programs.

* "Dolby" and the double-D symbol are trade marks of Dolby Laboratories Inc. Noise reduction system manufactured under license from Dolby Laboratories Inc.

MULTIPATH switch

Check the multipath reception on fm by pushing this switch. If the SIGNAL MULTIPATH meter reads close to "0", no substantial amount of multipath is being received. If there is a moderate to large deflection, readjust the antenna.

MONO switch

Normally keep this switch released, and the receiver will operate in the stereo mode. If the switch is depressed, the receiver changes to the mono mode and each speaker provides mono sound.

Use this position when the received fm stereo signals are noisy, or when you adjust the stereo balance.

EXT ADPT (External Adaptor) switch

Normally keep this switch released. Depress this switch when you use an add-on external adaptor, such as a graphic equalizer, a SQ adaptor, a third tape recorder, etc. connected to the EXT ADPT jacks on the rear panel.

AUX input jack (front panel)

Connect a tape recorder, an additional tuner, etc., as an auxiliary source by means of a cord with a binaural plug. The connection to this jack will cut off the input signal from the AUX input jacks on the rear panel.

The EXT ADPT jacks accept an add-on adaptor such as a graphic equalizer, speaker equalizer, SQ adaptor (for a quadraphonic sound setup), or third tape recorder. Connect the EXT ADPT OUTPUT jacks to the inputs of the add-on equipment and the EXT ADPT INPUT jacks to the outputs of the equipment.

When using these jacks, be sure to depress the front panel EXT ADPT switch. When not in use, release the switch. If these precautions are not observed, the signal path is not completed and no sound will be heard.

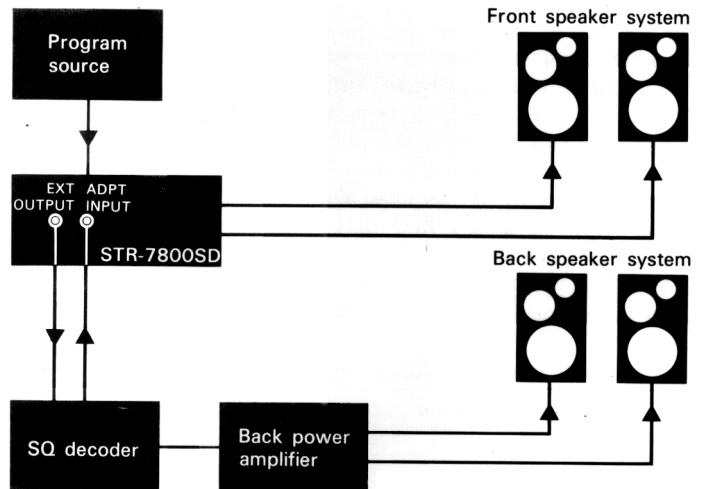

CARE OF YOUR EQUIPMENT

www.hifi-museum.com

TROUBLE CHECKS

The following chart will help correct most problems which may occur with the unit. If the problem persists after you have made these checks, consult your Sony dealer.

Before going through the check list below, first refer back to the "Connection Diagram" and "Operation".

Off-the-air programs

SIGNAL MULTIPATH meter is unstable.

- Adjust the antenna.

STEREO lamp does not light when receiving stereo programs.

- Keep the MONO switch released.

Severe hum or noise

- Tune accurately.
- Use shielded antenna lead.
- Avoid long horizontal runs of antenna lead.
- Adjust the antenna.

Ignition noise

- Install the outdoor antenna away from heavy traffic.
- Use a coaxial cable for antenna connection.

Other program sources

No audio

- Depress the POWER switch.
- Check that the ac power cord is plugged into a working outlet.
- Check speaker cord connections and input connections.
- Turn the VOLUME control clockwise.
- Check that the MUTING switch is set at the upper position.
- Check the FUNCTION selector setting.
- Check the MONITOR selector setting.
- Check the SPEAKER selector setting.
- Check that the EXT ADPT switch is released when an external adaptor is not connected.

No audio from one channel or unbalanced left and right volume

- Adjust the BALANCE control
- Check the speaker and input connections of the inoperative channel.

No recording

- Check that the TAPE COPY selector is set at SOURCE.

No tape copying

- Check the TAPE COPY selector setting.

Reverse left and right sound

- Check the speaker cord connection and speaker location.
- Check the input connections.

Lack of bass sound or obscure instrument position.

- Check the speaker connection for proper phasing.

Severe hum or noise

- Use shielded connecting cords.
- Keep connecting cords away from transformers or motors, and at least 3 meters (10 feet) from TV sets and fluorescent lights.
- Ground the receiver.

Rustling noise

- Make secure connections.
- Wipe the plugs and jacks with a cloth lightly dampened with methanol.

CLEANING

Clean the cabinet, panel and knobs periodically with a soft cloth. If finger prints, food and beverage stains, etc. are difficult to remove, use a cloth moistened with a mild detergent solution. Do not use any type of scouring powder, abrasive pad or solvent.

DOLBY ENCODED FM BROADCASTS

Noise in the high-frequency range of fm programs has always been a problem in the reproduction of high-quality sound. Up to the present, to correct this problem, a 75-microsecond pre-emphasis/de-emphasis process has been used in fm broadcasting. This consists of boosting the upper audio frequency portion an amount proportional to frequency in broadcasting and returning it to normal relationship in reception. Recently, remarkable progress in disc and other program source manufacturing techniques made possible increased high-frequency components in the programs, so that a 75-microsecond pre-emphasis system presently causes problems such as distortion by overmodulation in the high-frequency range, or the alternative of a loss of dynamic range from the use of limiters that prevent such overmodulation. To correct this situation, the Dolby Laboratories proposed a new method of broadcasting using the Dolby B system, in combination with a 25-microsecond pre-emphasis characteristic, instead of the previous 75-microsecond characteristic.

The Dolby system by itself boosts low-level upper audio frequencies to a greater extent than high-level upper audio frequencies, thus providing a variable, or dynamic pre-emphasis characteristic. The 25-microsecond pre-emphasis boosts the upper audio frequencies in a manner proportional to frequency, but not to the larger degree present in the 75-microsecond system.

Thus the combination of these two procedures in the new broadcasting system is able to avoid the problem of overmodulation and to increase the average audio level in transmitting so that a greatly improved signal-to-noise ratio and greater dynamic range can be obtained. This new system is also compatible with the conventional system of 75-microsecond pre-emphasis, so approximately correct frequency balance can be obtained with existing tuners without the Dolby decoder. The FCC authorized this new system on June, 1974.

With its integral Dolby decoder circuit, your new Sony receiver permits the reception of the presently available state-of-the-art Dolby fm broadcasts, with their greater dynamic range and improved signal-to-noise ratio.

SPECIFICATIONS

www.hifi-museum.com

AUDIO POWER SPECIFICATIONS

POWER OUTPUT AND TOTAL HARMONIC DISTORTION

With 8-ohm loads, both channels driven, from 20 – 20,000 Hz ; rated 125 watts per channel minimum RMS power, with no more than 0.07% total harmonic distortion from 250 milliwatts to rated output.

OTHER SPECIFICATIONS

Amplifier section

Damping factor 40 at 1 kHz, 8 ohms
 Intermodulation (IM) distortion (60 Hz : 7 kHz = 4 : 1)
 Less than 0.07% at rated output
 Less than 0.05% at 1 W output
 Residual noise Less than 0.7 mV

Input

	Sensitivity	Impedance	S/N	Weighting network
PHONO 1, 2	2.5 mV	50,000 ohms	72 dB	A
AUX TAPE 1, 2 EXT ADPT	250 mV	100,000 ohms	90 dB	A

Measured with rated output power into 8-ohm loads (both channels driven simultaneously) at 1 kHz.

Outputs (with rated input)

	Voltage	Impedance
REC OUT 1, 2 EXT ADPT	250 mV	

HEADPHONES Accepts 8 – 10,000 ohm headphones.

SPEAKER 4 – 16 ohm speakers are suitable.

Frequency response PHONO 1, 2
 RIAA equalization curve ± 0.5 dB
 AUX
 TAPE 1, 2
 EXT ADPT

10 Hz – 30 kHz $\begin{matrix} +0 \\ -2 \end{matrix}$ dB

Tone controls BASS ± 10 dB at 100 Hz

TREBLE ± 10 dB at 10 kHz

Filters HIGH 6 dB/oct. above 5 kHz
 6 dB/oct. above 10 kHz
 LOW 6 dB/oct. below 50 Hz
 6 dB/oct. below 25 Hz

Acoustic compensator (att. 30 dB)

LOW +9 dB at 50 Hz

PRESENCE +3 dB at 1 kHz

LOUDNESS +10 dB at 50 Hz
 +3 dB at 10 kHz

FM tuner section

Tuning 87.5 MHz – 108 MHz
 Antenna 300 ohm balanced
 75 ohm unbalanced
 Intermediate frequency 10.7 MHz
 Sensitivity at 50 dB quieting
 3.5 μ V (MONO)
 45 μ V (STEREO)
 Usable sensitivity IHF 1.7 μ V (MONO)
 Signal-to-noise ratio 73 dB (MONO)
 68 dB (STEREO)
 Harmonic distortion at 100 Hz
 0.2% (MONO)
 0.3% (STEREO)
 at 1 kHz
 0.2% (MONO)
 0.3% (STEREO)
 at 10 kHz
 0.2% (MONO)
 0.6% (STEREO)
 IM distortion 0.2% (MONO)
 0.3% (STEREO)
 Separation 35 dB at 100 Hz
 40 dB at 1 kHz
 35 dB at 10 kHz
 Frequency response 30 Hz – 15 kHz $\begin{matrix} +0.2 \\ -1.5 \end{matrix}$ dB
 Alternate channel selectivity 80 dB (400 Hz)
 Capture ratio 1.0 dB
 AM suppression ratio 54 dB
 Image response ratio 75 dB
 IF response ratio 100 dB
 Spurious response ratio 100 dB
 RF intermodulation 70 dB
 Sub-carrier product ratio 60 dB
 SCA rejection ratio 60 dB
 Muting threshold Approx. 5 μ V
 FM DISCRI output level 250 mV, 2,500 ohms, at 1 kHz
 100% modulation

AM tuner section

Tuning range 530 kHz – 1,605 kHz
 Antenna Built-in ferrite-bar antenna
 External antenna terminal
 Intermediate frequency 455 kHz
 Usable sensitivity 250 μ V/m, built-in antenna
 100 μ V, external antenna
 at 1,000 kHz
 Signal-to-noise ratio 50 dB at 50 mV/m
 Harmonic distortion 0.5% at 50 mV/m, 400 Hz
 Selectivity 35 dB
 Image response ratio 40 dB at 1,000 kHz
 IF response ratio 35 dB at 1,000 kHz

General

System	Superheterodyne fm/a-m tuner, Complementary symmetry power amplifier circuit (SEPP OTL)
Power requirements	120 V ac, 60 Hz
Power consumption	300 W (for the USA model) 650 VA (for the Canadian model)
Ac outlets	3 unswitched, total 200 W
Dimensions	Approx. 490×170×515 mm (w/h/d) (19 1/4×6 9/16×20 5/16 inches) including projecting parts and controls
Weight	Approx. 22.8 kg (50 lb 4 oz) net Approx. 26.6 kg (58 lb 10 oz) in shipping carton
Supplied accessories	Fm ribbon antenna 1 Shorting plugs 2 Polishing cloth 1

Design and specifications subject to change without notice.

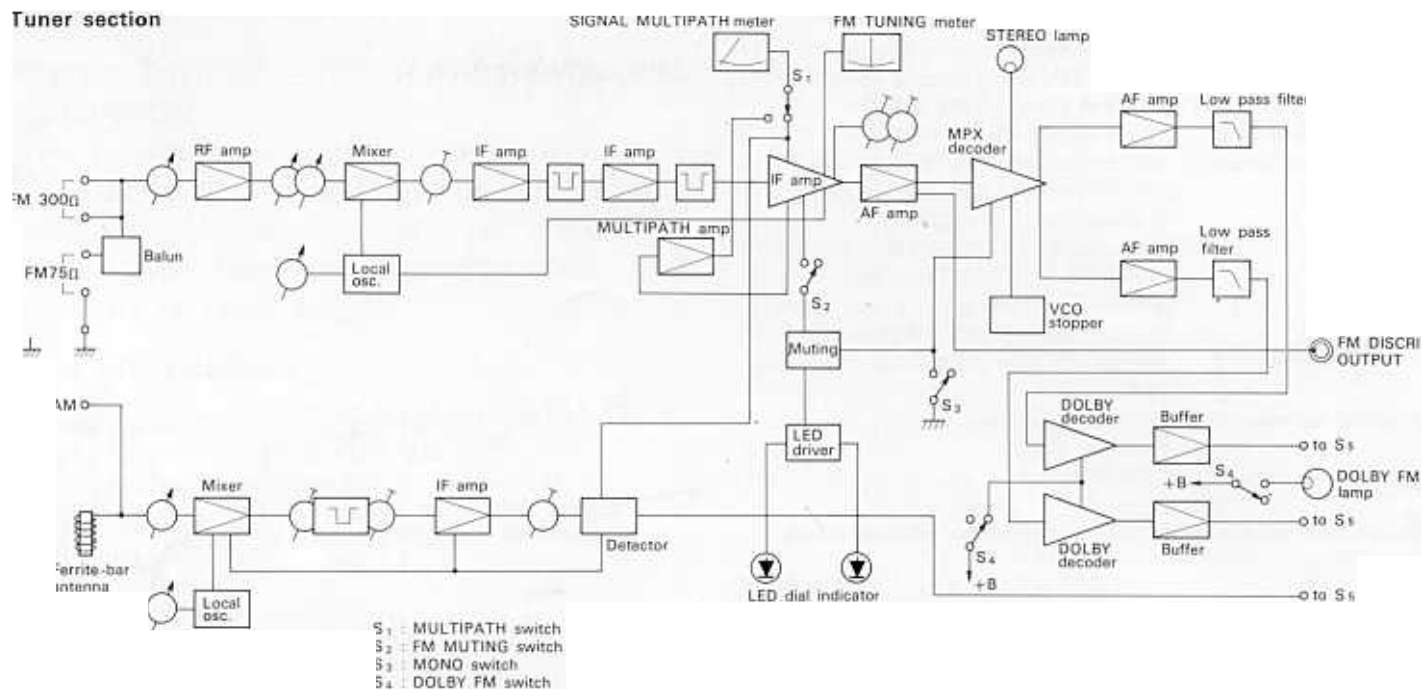

Amplifier section

