

TA-F222ESA/F570ES

SERVICE MANUAL

Canadian Model
AEP Model
TA-F570ES
E Model
TA-F222ESA



Photo : TA-F570ES

SPECIFICATIONS

Amplifier Section

Items	Condition		Data
			TA-F222ESA/TA-F570ES
Continuous RMS power output (both channels driven simultaneously)	4 ohm, 20 Hz - 20 kHz	Countries other than North European countries	120 W + 120 W (THD 0.01%) (DIN: 175 W + 175 W)
		North European countries	95 W + 95 W (THD 0.006%) (DIN: 115 W + 115 W)
	8 ohms, 20 Hz - 20 kHz	Countries other than North European countries	90 W + 90 W (THD 0.004%) (DIN: 110 W + 110 W)
		North European countries	80 W + 80 W (THD 0.004%) (DIN: 100 W + 100 W)
Power band width (IHF)	8 ohms, THD 0.02%		10 Hz - 100 kHz at 45 W
Dynamic headroom (78 IHF)	4 ohms		2 dB
	8 ohms		1.2 dB
Total harmonic distortion	8 ohms, at 10 watt output		0.004%
Intermodulation (IM) distortion 60 Hz : 7 kHz = 4 : 1	4 ohms, at rated output		0.008%
	6 ohms, at rated output		0.006%
	8 ohms, at rated output		0.004%
Damping factor	8 ohms, at 1 kHz		100
Residual noise	network A, 8 ohms		less than 100 μ V
Frequency response	PHONO MM		RIAA equalization curve ± 0.2 dB
	TUNER, CD TAPE 1,2,3, DIRECT IN		2 Hz - 200 kHz -3 dB
Input sensitivity	PHONO	MC	0.17 mV 100 ohms
		MM	2.5 mV, 50 kohms
	TUNER, CD, DIRECT IN, TAPE 1,2,3, ADAPTOR, AUX		150 mV, 20 kohms

Items	Condition		Data
			TA-F222ESA/TA-F570ES
S/N (network) (78 IHF)	PHONO	MC	77 (0.5 mV)
		MM	95 (5.0 mV)
	TUNER, CD, DIRECT IN, TAPE 1,2,3, ADAPTOR, AUX		105 (150 mV)
Output voltage impedance	REC OUT 1,2,3 ADAPTOR		150 mV, 1 kohm
	HEADPHONES		25 milliwatts (at 8 ohms) Accepts low and high impedance headphones.
Tone controls	BASS, at 100 Hz		± 7 dB
	TREBLE, at 10 kHz		± 6 dB
Subsonic filter	-		6 dB/octave attenuation below 15 Hz
Muting	-		-20dB

General

System Preamplifier section: Low-noise high gain NFB type equalizer amplifier, passive type direct tone control
Power amplifier section: Pure-complementary SEPP power amplifier,

Power requirements

Canadian model: 120V AC, 60Hz
AEP, G model : 220-230V AC, 50/60 Hz
E model : 120V, 220V, or 240V AC, adjustable, 50/60Hz

— continued on next page —

INTEGRATED STEREO AMPLIFIER
SONY[®]

TA-F222ESA/F570ES

Power consumption

Canadian model	520VA
North European model	180W
AEP, G model	260W
E models	260W

AC outlet

Canadian model	2 switched, 120W/1 A max. 1 unswitched, 120W/1A max.
AEP, G model	—
E models	1 switched, 100 W max.

Dimensions Approx. 430×150×375mm (w/h/d)
 (17×5⁷/₈×14³/₄ inches)

weight Approx. 12kg (26 lbs 8 oz) net

Design and specifications subject to change without notice.

Note

This appliance conforms with EEC directive 87/308/EEC regarding interference suppression.

MODEL IDENTIFICATION

—Model Number Label—

TA-F222ESA
TA-F570ES

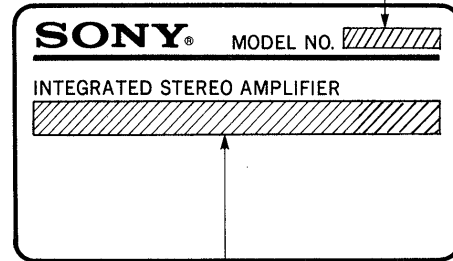



Canadian model: AC 120V 60Hz 400VA

AEP, G model : AC 220V—230V~50/60Hz

E model : AC120/220/240V~50/60Hz 230W

• G model: Germany model

SAFETY-RELATED COMPONENT WARNING!!

COMPONENTS IDENTIFIED BY MARK  OR DOTTED LINE WITH MARK  ON THE SCHEMATIC DIAGRAMS AND IN THE PARTS LIST ARE CRITICAL TO SAFE OPERATION. REPLACE THESE COMPONENTS WITH SONY PARTS WHOSE PART NUMBERS APPEAR AS SHOWN IN THIS MANUAL OR IN SUPPLEMENTS PUBLISHED BY SONY.

ATTENTION AU COMPOSANT AYANT RAPPORT À LA SÉCURITÉ!

LES COMPOSANTS IDENTIFIÉS PAR UNE MARQUE  SUR LES DIAGRAMMES SCHÉMATIQUES ET LA LISTE DES PIÈCES SONT CRITIQUES POUR LA SÉCURITÉ DE FONCTIONNEMENT. NE REMPLACER CES COMPOSANTS QUE PAR DES PIÈCES SONY DONT LES NUMÉROS SONT DONNÉS DANS CE MANUEL OU DANS LES SUPPLÉMENTS PUBLIÉS PAR SONY.

Function of Controls

Front panel

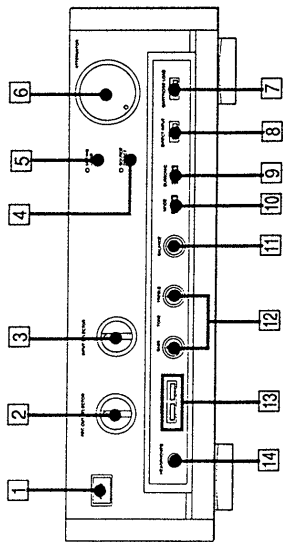

- 1 POWER switch and indicator**
After the power is turned on, the standby indicator lights in red as the built-in muting circuit activates. When the amplifier stays in a stable operating condition, the indicator lights in green.
The indicator lights in red if the unit detects shorting of circuit of the speaker outputs or in case of short-circuit of the inputs of DC components. In such a case, disconnect the power source and check the connected components and speaker systems.
- 2 REC OUT SELECTOR**
Selects the program source sent to the REC OUT jacks for recording.
- 3 INPUT SELECTOR**
Selects the desired program source for listening.
- 4 SOURCE DIRECT button and indicator**
Depress the button. The red indicator lights and the circuits of the TONE control, SUBSONIC filter button, BALANCE control and MODE selector are disengaged without regard to the setting of the switches.
- 5 MUTING button and indicator**
Depress the button to reduce the sound level by 20 dB. (Output voltage becomes 1/10.)
Generally, keep the button released (OFF).
- 6 ATTENUATOR**
Adjusts the sound level. To increase the sound level, turn the control clockwise. To decrease the level, turn the control counterclockwise.
- Note**
Turn down the sound level before switching on the unit. This prevents damage to speakers.
- 7 CARTRIDGE LOAD selector**
Set the selector according to your cartridge.
MM: For moving-magnet type cartridge
MC: For moving-coil type cartridge
- 8 DIRECT INPUT selector**
Set to SOURCE to select program source with the INPUT SELECTOR.
To listen to a program source processed through the equipment, such as graphic equalizer, connected to the ADAPTOR jacks, set it to SOURCE.
To listen to a program source connected to DIRECT IN jacks, set it to DIRECT.
- 9 SUBSONIC filter button**
Depress the button to reduce noise components of less than 15 Hz, which cause modulation noise.
- 10 MODE selector**
STEREO: For listening to a stereo program.
MONO: For listening to a monaural program.
- 11 BALANCE control**
Adjusts the sound level of left and right speakers.
- 12 BASS and TREBLE TONE controls**
Adjust the tone quality.
To increase bass or treble sound, turn the control clockwise. To decrease them, turn the control counterclockwise.
- 13 SPEAKERS buttons**
Select speaker system A or B, or both.
To drive speaker system A: Depress A button.
To drive speaker system B: Depress B button.
To drive speaker system A and B: Depress A and B.
For headphones listening only: Set both to OFF (□).
- 14 HEADPHONES jack**
Accepts the stereo phone plug of headphones.

SECTION 1 GENERAL

This section is extracted from instruction manual.

SECTION 2 ELECTRICAL ADJUSTMENTS

Bias Adjustment

Note: Adjust the idling after tuning the unit on for about 10 minutes, giving it time to warm up.

Procedure :

1. Connect the digital voltmeter to VH5 on main board as follows.
2. Adjust RT301 (L-CL) and RT351 (R-CH) so that the digital voltmeter on signal reads 14mV at VH5.

Adjustment Location :

[MAIN BOARD]
(component side)

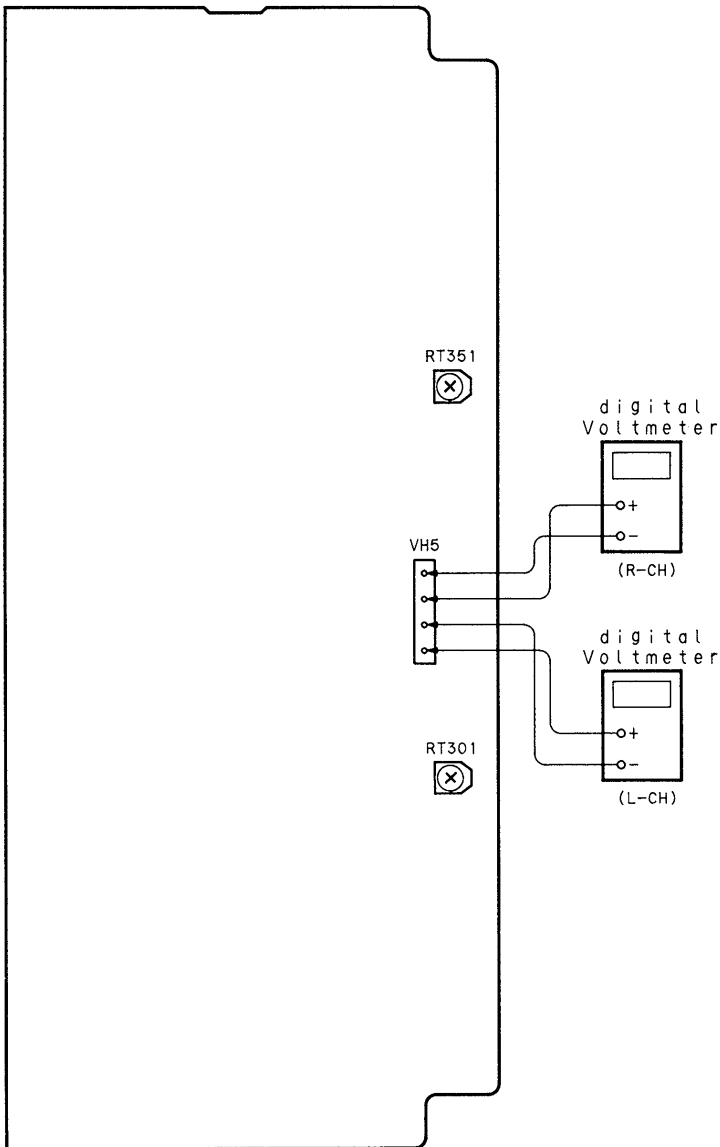

SECTION 3 DIAGRAMS

3-1. CIRCUIT BOARDS LOCATION

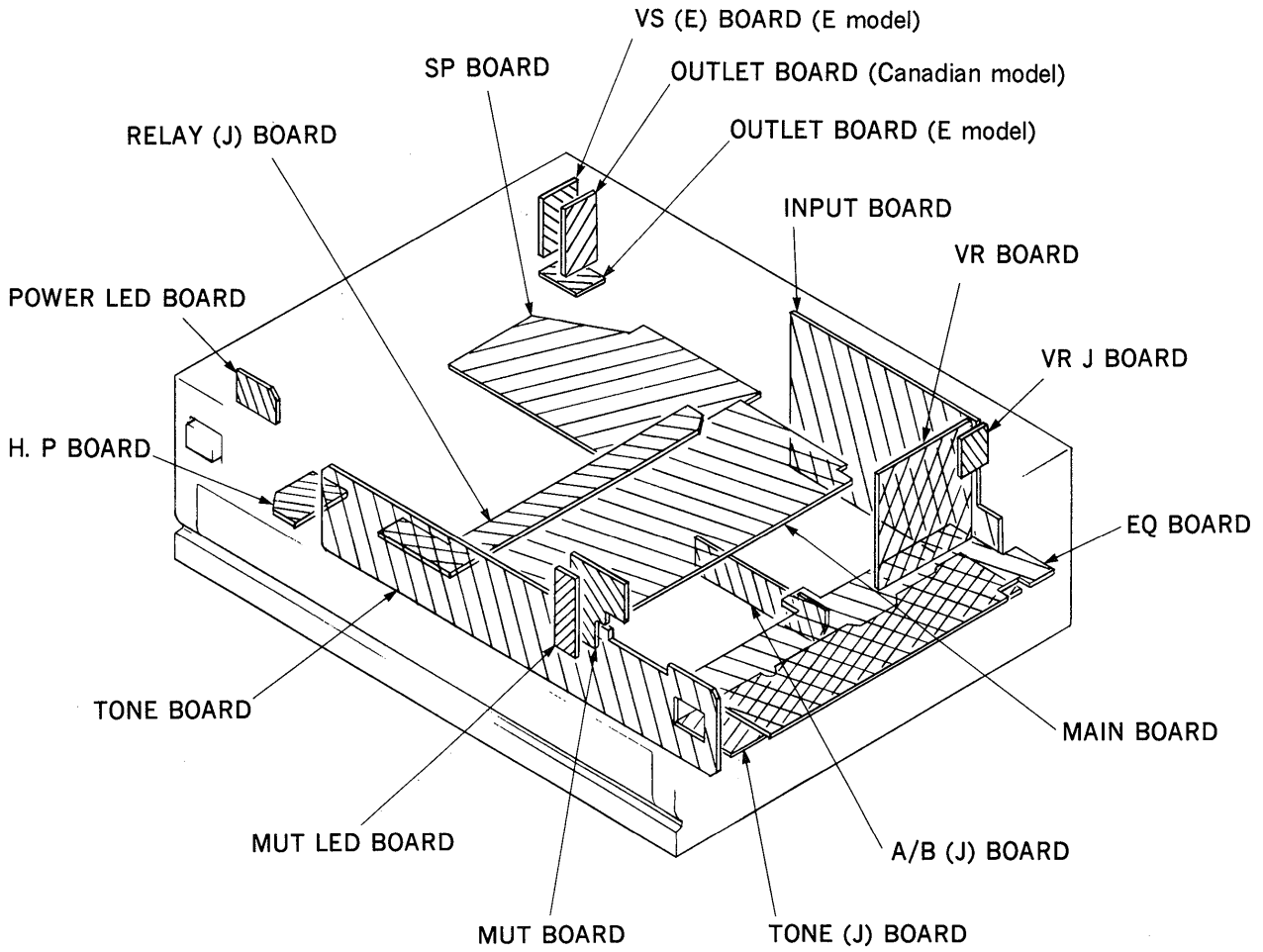

3-2. SEMICONDUCTOR LEAD LAYOUTS

RC4560DD

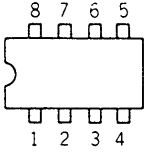

(Top view)

TA7815S

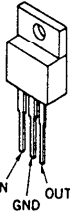

TA-7915S

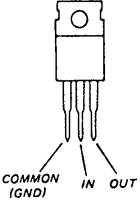

μ PC1237HA

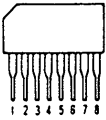

2SA733-QP
2SC945-P



2SA985A-QP
2SC2275A-P

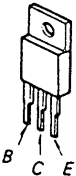

2SA988-PAFAEA
2SA1371-E
2SC2545-E

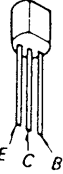

2SA1216M-OY
2SC2922M-OY



2SC1941-LK
2SD774-34

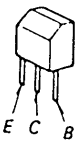

2SC2259-FG

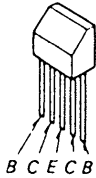

2SC2603-EF

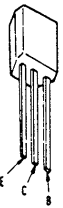

2SC3423-0



2SK246-GR2

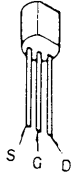

HZS6C3L
UZL-7M1
1SS120
11ES2

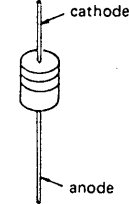

30DF2

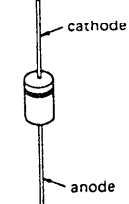

SEL1516W
SEL2810A

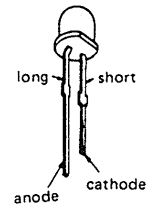

• Semiconductor Location

Location	Ref. No.	Location	Ref. No.
D301	H-19	Q302	G-19
D302	H-19	Q303	G-19
D303	H-19	Q304	H-18
D304	G-20	Q305	H-19
D305	G-20	Q306	H-19
D306	G-19	Q307	H-19
D307	I-22	Q308	H-20
D308	I-23	Q309	H-22
D309	J-23	Q310	H-23
D351	I-19	Q311	H-23
D352	I-19	Q312	I-22
D353	I-19	Q313	G-22
D354	J-20	Q314	J-23
D355	J-20	Q351	J-18
D356	J-19	Q352	J-19
D357	C-22	Q353	J-19
D358	C-23	Q354	I-18
D359	C-23	Q355	J-19
D401	F-19	Q356	J-19
D501	E-25	Q357	J-19
D502	E-25	Q358	I-20
D503	G-25	Q359	D-22
D504	G-25	Q360	D-23
D505	D-25	Q361	D-23
D506	E-25	Q362	C-22
D507	H-25	Q363	E-22
D508	H-26	Q364	B-23
D509	H-25	Q401	D-18
D510	H-25	Q402	D-18
D511	I-25	Q451	D-19
D512	F-3	Q452	D-19
D513	I-2	Q501	I-4
D514	I-2	Q502	I-3
D515	F-29	Q503	I-3
D516	F-30	Q504	I-2
D517	F-2	Q505	K-11
D518	H-5	Q506	K-12
D519	G-5		
D520	C-11		
D521	C-7		
IC401	E-19		
IC402	E-20		
IC403	F-20		
IC501	J-25		
Q301	G-18		

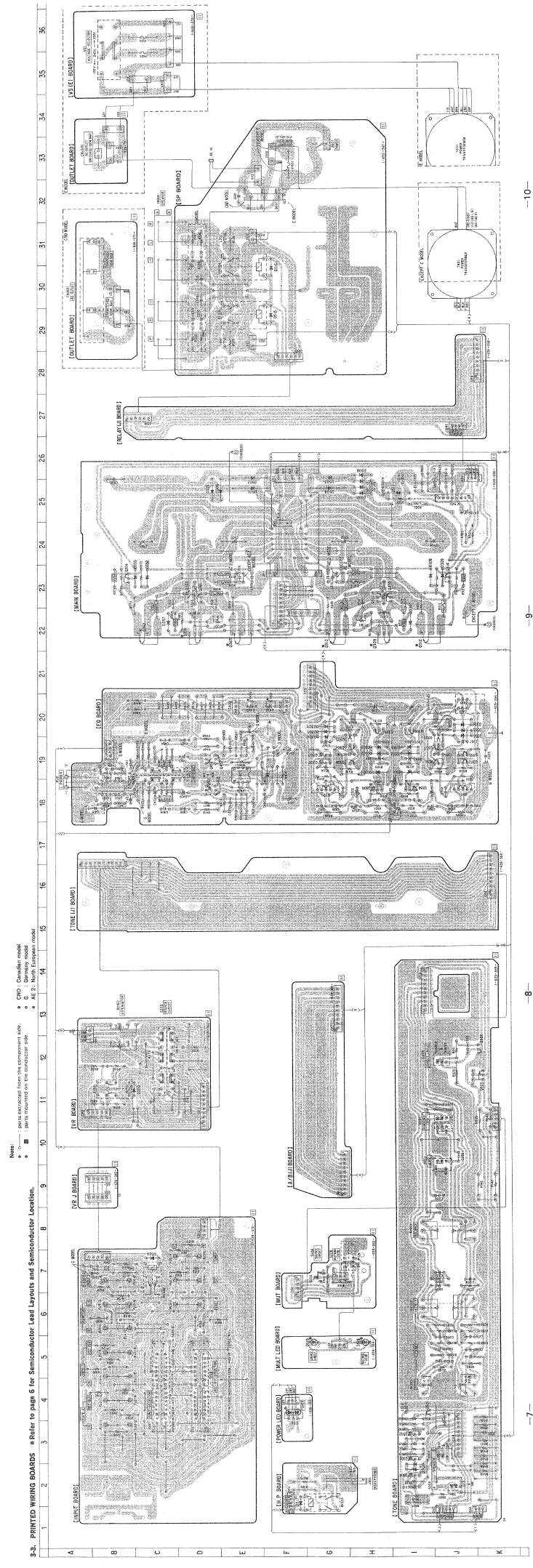

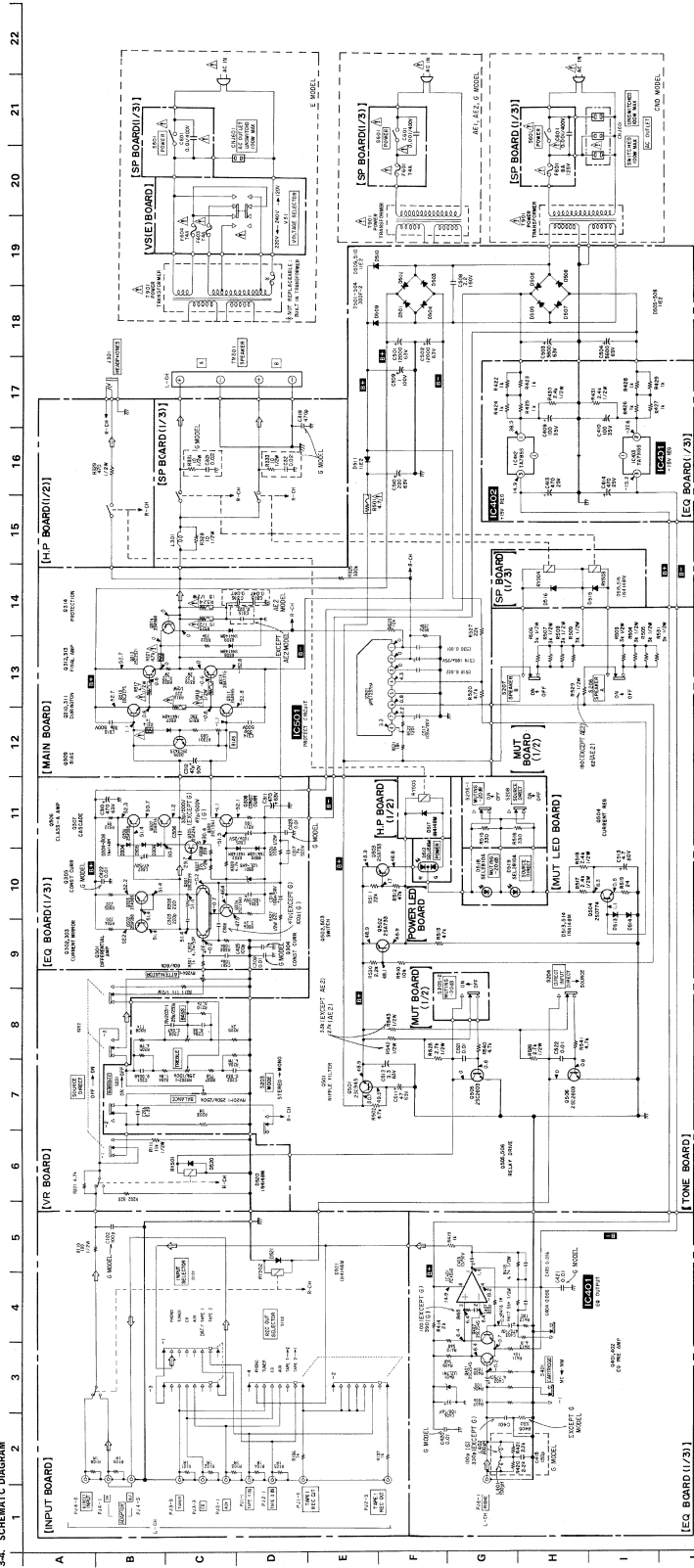

IC Block Diagram
IC921 PC15711A

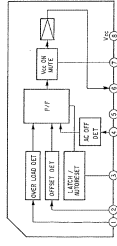

- Note:**
- Resistor values are in Ω unless otherwise noted. All resistors are 1% tolerance unless otherwise specified.
 - Components for right channel have same values as for left channel.
 - CND: non-dissipative capacitor.
 - RND: non-dissipative resistor.

- Note:**
- Voltage is dc with respect to ground.
 - Under original conditions, VOM (ohm) impedance (OM Ω).
 - Voltage variations may be noted due to normal production tolerances.
 - CND - Capacitor model
 - RND - Resistor model
 - AE 2: North European model

SECTION 4 EXPLODED VIEWS

NOTE:

- The mechanical parts with no reference number in the exploded views are not supplied.
- Items marked "*" are not stocked since they are seldom required for routine service. Some delay should be anticipated when ordering these items.

- -XX, -X mean standardized parts, so they may have some differences from the original one.

- Color Indication of Appearance Parts
Example:

KNOB, BALANCE (WHITE)...(RED)

Parts Color Cabinet's Color

- CND : Canadian model
- G : Germany model
- AE 2 : North European model

- Hardware(# mark) list is given in the last of this parts list.

The components identified by mark or dotted line with mark are critical for safety. Replace only with part number specified.

Les composants identifiés par une marque sont critiques pour la sécurité. Ne les remplacer que par une pièce portant le numéro spécifié.

1. CABINET

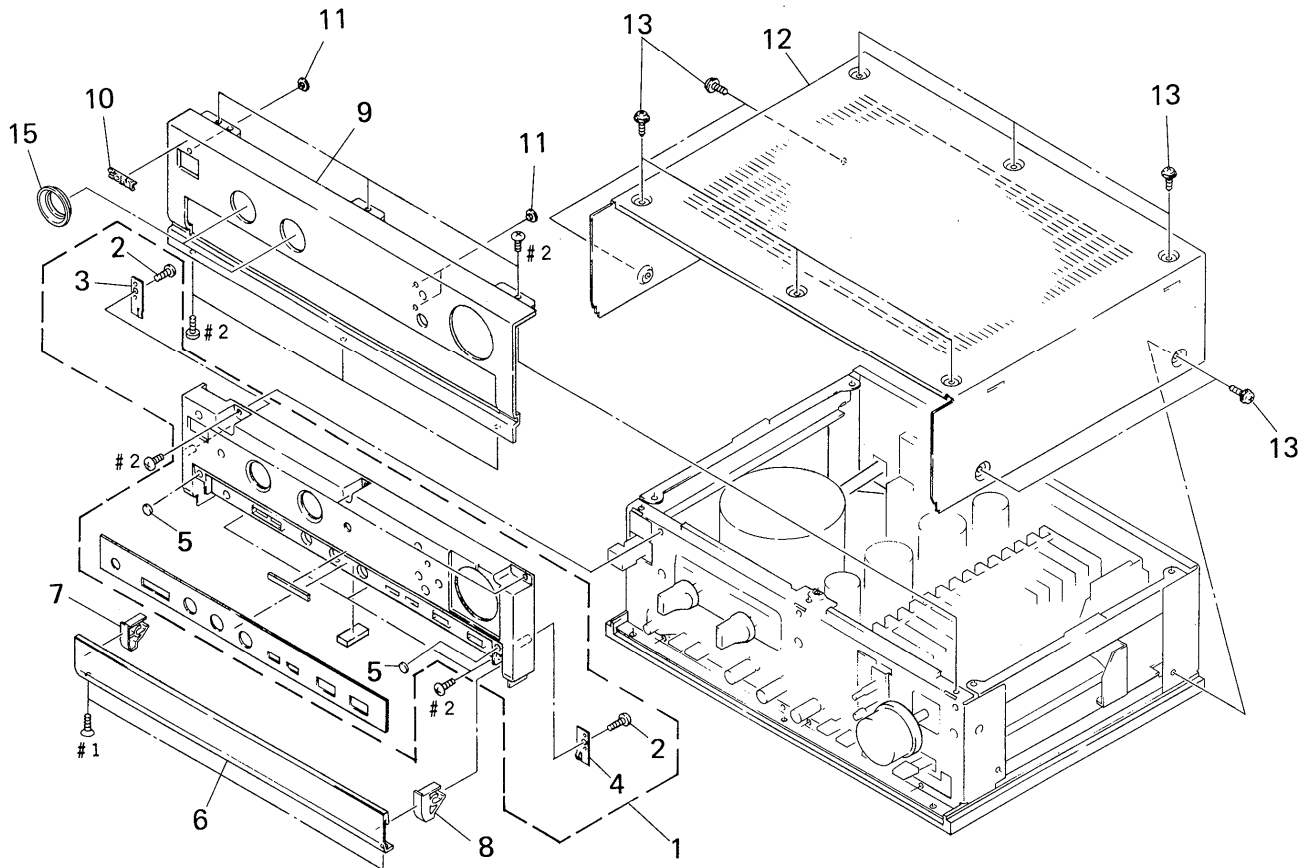

Ref. No.	Part No.	Description	Remark	Ref. No.	Part No.	Description	Remark
1	X-4941-787-1	PANEL (BASE) ASSY		9	4-946-348-01	PANEL, FRONT (AEP, G)	
2	4-928-635-01	SCREW, +BV (2.6X8) TAPPING		9	4-946-348-11	PANEL, FRONT (Canadian)	
3	* 4-942-233-01	SPRING (L), PLATE		9	4-946-348-21	PANEL, FRONT (E)	
4	* 4-942-234-01	SPRING (R), PLATE		10	4-908-848-01	EMBLEM, SONY	
5	4-879-274-01	SPACER		11	4-931-646-01	LENS, LED	
6	4-946-346-01	LID		12	* 4-946-347-01	CASE (Canadian, AE1, G, E)	
7	4-942-225-01	ARM (L)		12	* 4-946-347-11	CASE (AE2)	
8	4-942-226-01	ARM (R)		13	3-704-366-01	SCREW (CASE) (M3X8)	

2. SUB CHASSIS

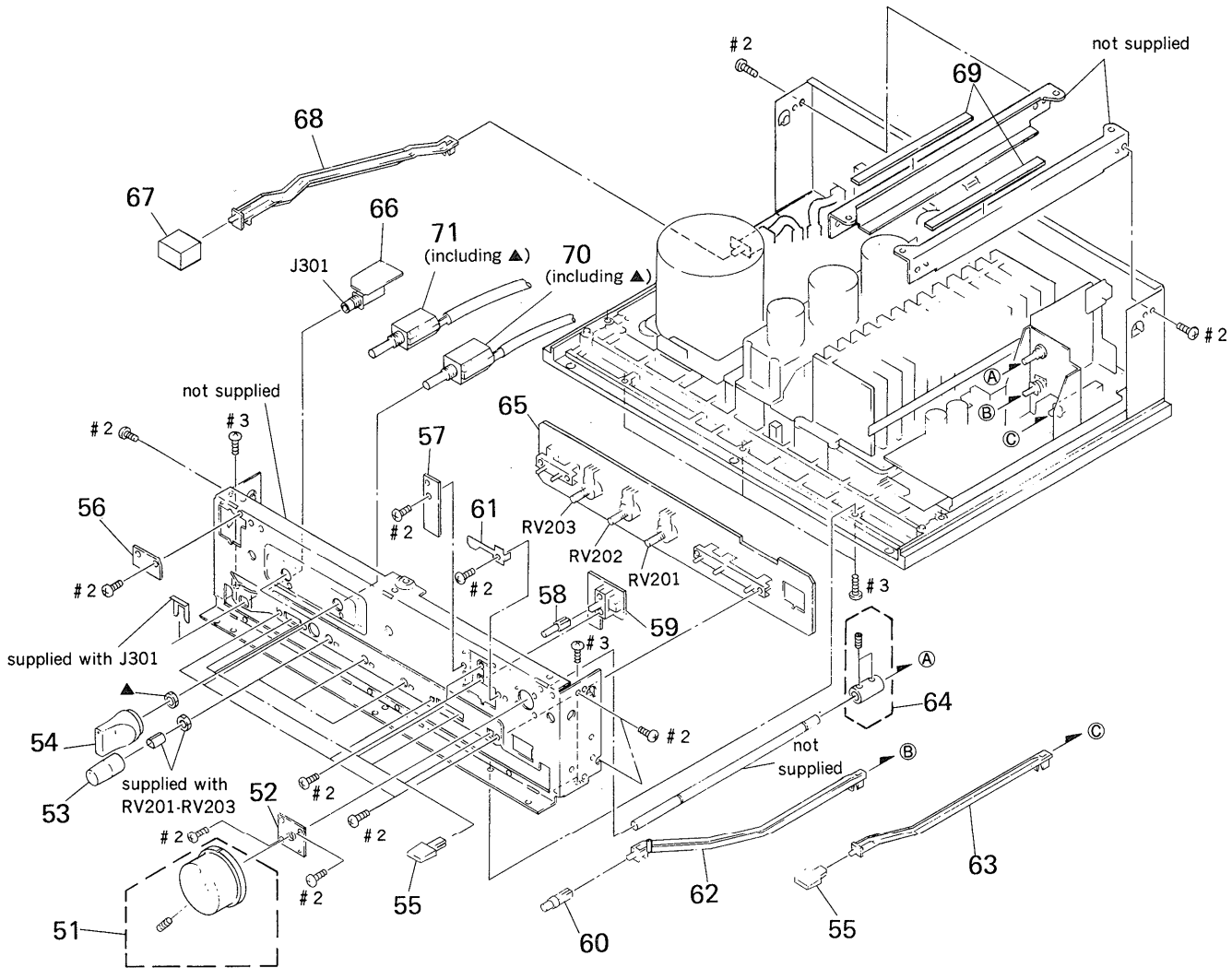

Ref. No.	Part No.	Description	Remark
51	4-946-332-01	KNOB (VOL-S)	
52	4-946-335-01	BRACKET (BEARING)	
53	4-946-333-01	KNOB (TONE)	
54	4-945-601-01	KNOB (F25)	
55	4-942-228-01	KNOB (3X13)	
56	* 1-639-365-11	POWER LED BOARD	
57	* 1-639-364-11	MUT LED BOARD	
58	4-931-641-01	BUTTON (DIA. 4)	
59	* 1-639-363-11	MUT BOARD	
60	4-931-926-01	BUTTON (B)	
61	4-946-732-01	SPRING (S), LEAF	
62	4-946-339-01	ROD (S)	
63	4-946-338-01	ROD (C)	

Ref. No.	Part No.	Description	Remark
64	* 4-946-330-01	JOINT	
65	* 1-639-362-11	TONE (J) BOARD	
66	* 1-639-361-11	HP BOARD	
67	4-942-032-01	KNOB (POWER)	
68	4-946-340-01	ROD (P)	
69	* 4-916-782-21	DAMPER	
70	1-572-742-11	SWITCH, ROTARY	
71	1-572-743-11	SWITCH, ROTARY	
J301	1-507-796-71	JACK (HEADPHONES)	
RV201	1-241-517-11	RES, VAR, CARBON 250K/250K (BALANCE)	
RV202	1-241-518-11	RES, VAR, CARBON 25K/100K (TREBLE)	
RV203	1-241-519-11	RES, VAR, CARBON 25K/250K (BASS)	

3. MAIN CHASSIS

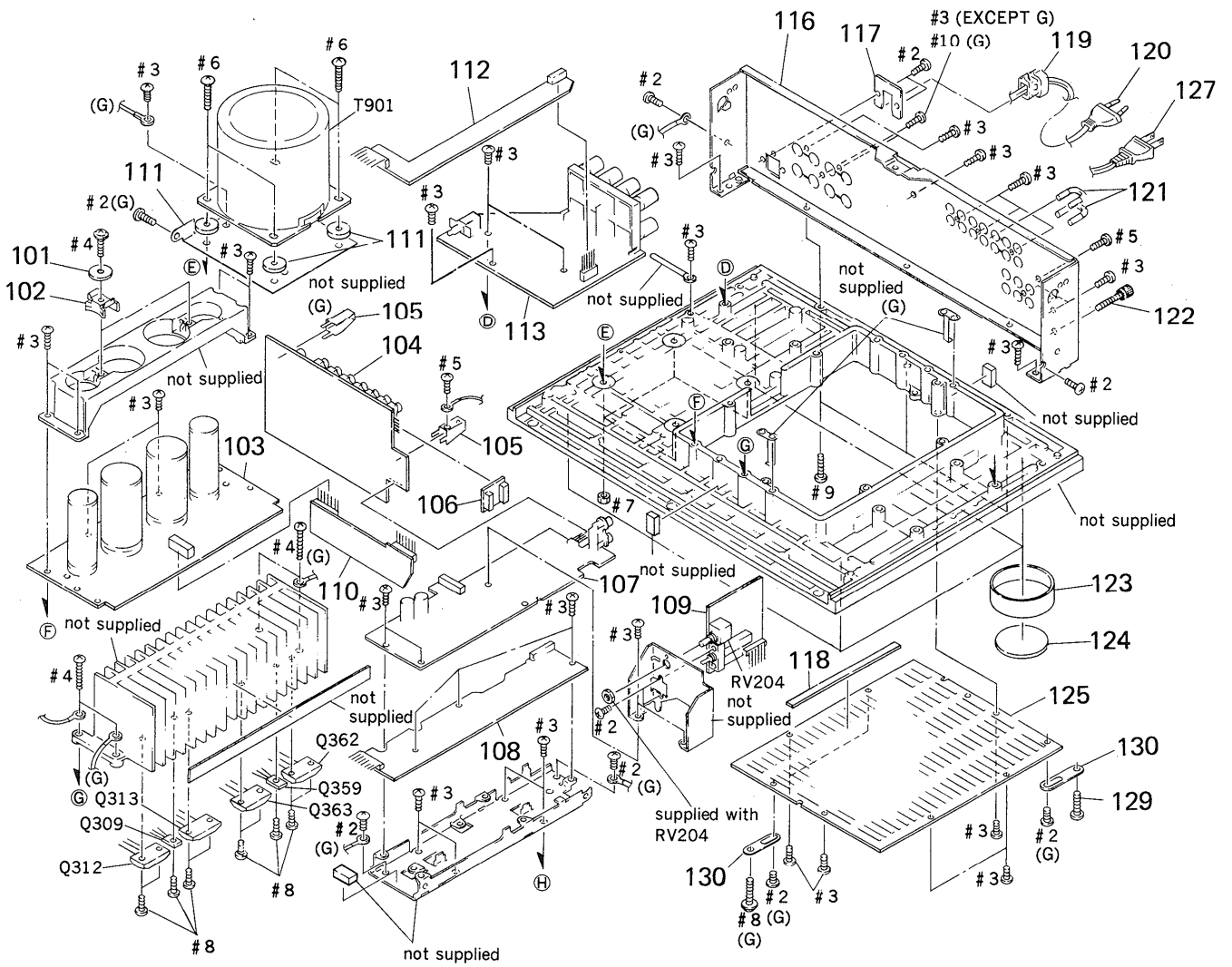
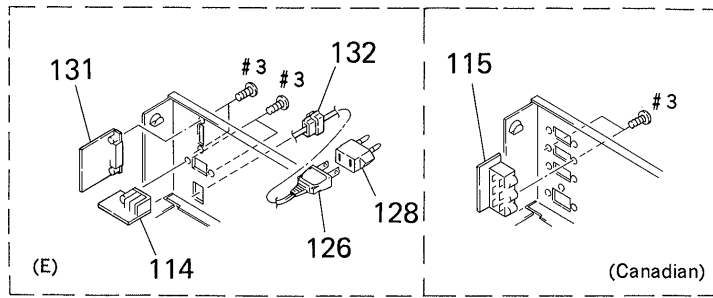

Ref. No.	Part No.	Description	Remark
101	4-945-833-11	WASHER (DIA. 14)	
102	4-946-329-01	RETAINER, ELECT CAP	
103	* A-4345-377-A	MAIN BOARD, COMPLETE (Canadian, AE1, E)	
103	* A-4345-378-A	MAIN BOARD, COMPLETE (AE2)	
103	* A-4345-665-A	MAIN BOARD, COMPLETE (G)	
104	* 1-639-372-11	INPUT BOARD	
105	* 4-946-336-01	BRACKET (GROUND)	
106	* 1-639-382-11	VR J BOARD	
107	* A-4345-390-A	EQ BOARD, COMPLETE (EXCEPT G)	
107	* A-4345-391-A	EQ BOARD, COMPLETE (G)	
108	* A-4345-379-A	TONE BOARD, COMPLETE (EXCEPT AE2)	
108	* A-4345-380-A	TONE BOARD, COMPLETE (AE2)	
109	* 1-639-360-11	VR BOARD	
110	* 1-639-369-11	A/B J BOARD	
111	4-885-984-21	WASHER (Canadian, AEP, E)	
112	* 1-639-368-11	RELAY (J) BOARD	
113	* 1-639-367-11	SP BOARD	
114	* 1-639-761-11	OUTLET BOARD (E)	
115	* 1-639-371-11	OUTLET BOARD (Canadian)	
116	* 4-944-612-01	PANEL, BACK (AE1, G)	
116	* 4-944-612-11	PANEL, BACK (AE2)	
116	* 4-944-612-21	PANEL, BACK (E)	
116	* 4-944-612-31	PANEL, BACK (Canadian)	
117	* 4-923-873-01	BRACKET, CORD STOPPER (F570ES)	
118	* 4-916-782-21	DAMPER	

Ref. No.	Part No.	Description	Remark
119	* 3-703-244-00	BUSHING (2104), CORD (F570ES)	
120	△. 1-574-805-11	CORD, POWER (AEP, G)	
121	1-535-706-11	PLUG, JUMPER	
122	* 4-941-033-01	SCREW, FIXED, FEEDER	
123	4-923-882-02	RING (LARGE-16), ORNAMENTAL, FOOT	
124	* 4-923-850-01	FOOT (DIA. 46)	
125	* 4-916-732-01	BOARD, BOTTOM	
126	△. 1-574-381-11	CORD, POWER (E)	
127	△. 1-575-975-11	CORD, POWER (Canadian)	
128	△. 1-526-565-00	AC PLUG ADAPTOR (E)	
129	4-921-437-01	SCREW (M3X20), TAPPING (G)	
130	* 4-941-988-01	BRACKET (GROUND) (G)	
131	* 1-639-370-11	VS (E) BOARD (E)	
132	* 3-703-571-11	BUSHING (S) (4516), CORD (F222ESA)	
Q309	8-729-203-45	TRANSISTOR 2SC3423-0	
Q312	8-729-320-03	TRANSISTOR 2SC2921M-0	
Q313	8-729-320-01	TRANSISTOR 2SA1215M-0	
Q359	8-729-203-45	TRANSISTOR 2SC3423-0	
Q362	8-729-320-03	TRANSISTOR 2SC2921M-0	
Q363	8-729-320-01	TRANSISTOR 2SA1215M-0	
RV204	1-241-516-11	RES, VAR, CARBON 60K/60K (ATTENUATOR)	
T901	△. 1-450-500-11	TRANSFORMER, POWER (E)	
T901	△. 1-450-501-11	TRANSFORMER, POWER (AE2)	
T901	△. 1-450-502-11	TRANSFORMER, POWER (AE1, G)	
T901	△. 1-450-538-11	TRANSFORMER, POWER (Canadian)	

Note:

The components identified by mark △ or dotted line with mark △ are critical for safety. Replace only with part number specified.

Note:

Les composants identifiés par une marque △ sont critiques pour la sécurité. Ne les remplacer que par une pièce portant le numéro spécifié.



SECTION 5
ELECTRICAL PARTS LIST

EQ	SP	RELAY (J)
A/B (J)	VS (E)	OUTLET
		INPUT

NOTE:

- Due to standardization, replacements in the parts list may be different from the parts specified in the diagrams or the components used on the set.
- Items marked "∗" are not stocked since they are seldom required for routine service. Some delay should be anticipated when ordering these items.
- -XX, -X mean standardized parts, so they may have some differences from the original one.
- CAPACITORS
uF: μF

- RESISTORS
All resistors are in ohms
METAL: Metal-film resistor
METAL OXIDE: Metal Oxide-film resistor
F: nonflammable
- COILS
uH: μH
- SEMICONDUCTORS
In each case, u: μ, for example:
uA...: μA..., uPA...: μPA...,
uPB...: μPB..., uPC...: μPC...,
uPD...: μPD....
- CND: Canadian model
- G : Germany model
- AE 2: North European model

The components identified by mark  or dotted line with mark  are critical for safety. Replace only with part number specified.

Les composants identifiés par une marque  sont critiques pour la sécurité. Ne les remplacer que par une pièce portant le numéro spécifié.

When indicating parts by reference number, please include the board name.

Ref. No.	Part No.	Description	Remark	Ref. No.	Part No.	Description	Remark
	* A-4345-390-A	EQ BOARD, COMPLETE (EXCEPT G)		C308	1-101-880-00	CERAMIC 47PF 5%	50V
	* A-4345-391-A	EQ BOARD, COMPLETE (G)				(EXCEPT G)	
		*****		C308	1-110-335-11	FILM 100PF 5%	50V (G)
	* 1-639-367-11	SP BOARD		C309	1-130-483-00	MYLAR 0.01uF 5%	50V (G)
		*****		C310	1-126-066-11	ELECT 470uF 20%	63V
	* 1-639-368-11	RELAY (J) BOARD		C311	1-126-066-11	ELECT 470uF 20%	63V

	* 1-639-369-11	A/B (J) BOARD		C317	1-107-048-00	MICA 6.8PF	500V
		*****		C318	1-126-052-11	ELECT 100uF 20%	50V
	* 1-639-370-11	VS (E) BOARD (E)		C319	1-130-467-00	MYLAR 470PF 5%	50V (G)
		*****		C320	1-130-487-00	MYLAR 0.022uF 5%	50V (G)
	* 1-639-371-11	OUTLET BOARD (Canadian)		C321	1-130-487-00	MYLAR 0.022uF 5%	50V (G)
	* 1-639-761-11	OUTLET BOARD (E)					
		*****		C401	1-110-341-11	MYLAR 330PF 5%	50V
	* 1-639-372-11	INPUT BOARD				(EXCEPT G)	
		*****		C401	1-110-335-11	MYLAR 100PF 5%	50V (G)
				C402	1-123-369-00	ELECT 4.7uF 20%	50V
	* 1-533-213-31	HOLDER, FUSE		C403	1-126-103-11	ELECT 470uF 20%	16V
	* 4-946-336-01	BRACKET (GROUND)		C404	1-136-162-00	FILM 0.056uF 5%	50V
		< BUS BAR >		C405	1-137-471-91	FILM 0.016uF 5%	50V
BB1	* 1-560-242-61	BUS BAR 2P		C406	1-124-122-11	ELECT 100uF 20%	50V
BB2	* 1-560-242-61	BUS BAR 2P		C407	1-130-470-00	MYLAR 820PF 5%	50V
				C408	1-126-059-11	ELECT 10uF 20%	50V
		< CAPACITOR >		C409	1-123-345-00	ELECT 100uF 20%	35V
C102	1-162-282-31	CERAMIC 100PF 10%	50V (G)	C410	1-123-345-00	ELECT 100uF 20%	35V
C301	1-110-335-11	MYLAR 100PF 5%	50V	C413	1-124-913-11	ELECT 470uF 20%	50V
C302	1-123-369-00	ELECT 4.7uF 20%	50V	C414	1-124-913-11	ELECT 470uF 20%	50V
C303	1-110-339-11	MYLAR 220PF 5%	50V	C415	1-162-284-31	CERAMIC 150PF 10%	50V (G)
C304	1-124-122-11	ELECT 100uF 20%	50V	C420	1-161-379-00	CERAMIC 0.01uF 20%	25V (G)
C305	1-124-122-11	ELECT 100uF 20%	50V	C421	1-161-379-00	CERAMIC 0.01uF 20%	25V (G)
C306	1-107-159-00	MICA 33PF 5%	500V	C422	1-106-367-00	MYLAR 0.01uF 5%	200V (G)
		(EXCEPT G)		C423	1-106-367-00	MYLAR 0.01uF 5%	200V (G)
C306	1-162-815-11	CERAMIC 47PF 5%	500V (G)	C425	1-162-282-31	CERAMIC 100PF 10%	50V (G)
C307	1-124-910-11	ELECT 47uF 20%	50V	C601	 1-161-741-00	CERAMIC 0.001uF 10%	400V

EQ **SP** **RELAY (J)** **A/B (J)** **VS (E)** **OUTLET** **INPUT**

Ref. No.	Part No.	Description	Remark
< OUTLET >			
CNJ601	△. 1-540-062-31	OUTLET, AC (POLAR) (AC OUTLET) (Canadian)	
CNJ601	△. 1-540-039-11	OUTLET, AC (NONPOLAR) (1P) (AC OUTLET) (E)	
< CONNECTOR >			
CNP6	1-560-941-00	PIN, CONNECTOR 4P	
CP3	1-506-906-11	PIN, CONNECTOR 5P	
CP7	* 1-568-202-11	PIN, CONNECTOR (PC BOARD) 10P	
CP8	* 1-568-202-11	PIN, CONNECTOR (PC BOARD) 10P	
CP9	* 1-568-202-11	PIN, CONNECTOR (PC BOARD) 10P	
CP10	* 1-580-854-11	PIN, CONNECTOR (PC BOARD) 6P	
CS9	* 1-562-334-00	SOCKET, CONNECTOR 10P	
CS10	1-561-115-00	SOCKET, CONNECTOR 6P	
CS12	1-562-087-00	SOCKET, CONNECTOR 4P	
< DIODE >			
D301	8-719-933-41	DIODE HZS6C3L	
D302	8-719-912-20	DIODE 1SS120	
D303	8-719-912-20	DIODE 1SS120	
D304	8-719-912-20	DIODE 1SS120	
D305	8-719-912-20	DIODE 1SS120	
D306	8-719-912-20	DIODE 1SS120	
D351	8-719-933-41	DIODE HZS6C3L	
D352	8-719-912-20	DIODE 1SS120	
D353	8-719-912-20	DIODE 1SS120	
D354	8-719-912-20	DIODE 1SS120	
D355	8-719-912-20	DIODE 1SS120	
D356	8-719-912-20	DIODE 1SS120	
D401	8-719-000-84	DIODE UZL-7M1	
D515	8-719-912-20	DIODE 1SS120	
D516	8-719-912-20	DIODE 1SS120	
D521	8-719-912-20	DIODE 1SS120	
< CONNECTOR >			
DR6	* 1-564-338-00	PIN, CONNECTOR 4P	
EH2	* 1-564-506-11	PLUG, CONNECTOR 3P	
< FUSE >			
F601	△. 1-532-350-00	FUSE, TIME-LAG (T4A) (AEP, G)	
F601	△. 1-532-749-11	FUSE, GLASS TUBE (8A 125V) (Canadian)	
F603	△. 1-532-350-00	FUSE, TIME-LAG (T4A) (E)	
F604	△. 1-532-350-00	FUSE, TIME-LAG (T4A) (E)	
< IC >			
IC401	8-759-981-98	IC RC4560DD	
IC402	8-759-231-59	IC TA7815S	
IC403	8-759-245-87	IC TA7915S	

Ref. No.	Part No.	Description	Remark
< COIL >			
L301	1-428-133-11	COIL, AIR-CORE	
L351	1-428-133-11	COIL, AIR-CORE	
L401	1-424-397-11	COIL, CHOKE 200uH (G)	
L402	1-424-397-11	COIL, CHOKE 200uH (G)	
L451	1-424-397-11	COIL, CHOKE 200uH (G)	
L452	1-424-397-11	COIL, CHOKE 200uH (G)	
< PIN JACK >			
PJ1	* 1-573-142-41	JACK, PIN 4P (TAPE1 IN/REC OUT)	
PJ2	* 1-573-142-41	JACK, PIN 4P (TAPE2 IN/REC OUT)	
PJ3	1-568-978-21	JACK 6P (TUNER, CD, AUX)	
PJ4	1-568-978-21	JACK 6P (DIRECT INPUT, ADAPTOR IN/OUT)	
PJ6	1-580-054-11	JACK, PIN 2P (PHONO)	
< TRANSISTOR >			
Q301	8-729-620-17	TRANSISTOR 2SC2259-FG	
Q302	8-729-140-82	TRANSISTOR 2SA988-PAFAEA	
Q303	8-729-140-82	TRANSISTOR 2SA988-PAFAEA	
Q304	8-729-142-01	TRANSISTOR 2SC1941-LK	
Q305	8-729-201-56	TRANSISTOR 2SK246-GR2	
Q306	8-729-140-82	TRANSISTOR 2SA988-PAFAEA	
Q307	8-729-803-76	TRANSISTOR 2SA1371-E	
Q308	8-729-142-01	TRANSISTOR 2SC1941-LK	
Q351	8-729-620-17	TRANSISTOR 2SC2259-FG	
Q352	8-729-140-82	TRANSISTOR 2SA988-PAFAEA	
Q353	8-729-140-82	TRANSISTOR 2SA988-PAFAEA	
Q354	8-729-142-01	TRANSISTOR 2SC1941-LK	
Q355	8-729-201-56	TRANSISTOR 2SK246-GR2	
Q356	8-729-140-82	TRANSISTOR 2SA988-PAFAEA	
Q357	8-729-803-76	TRANSISTOR 2SA1371-E	
Q358	8-729-142-01	TRANSISTOR 2SC1941-LK	
Q401	8-729-354-52	TRANSISTOR 2SC2545-E	
Q402	8-729-354-52	TRANSISTOR 2SC2545-E	
Q451	8-729-354-52	TRANSISTOR 2SC2545-E	
Q452	8-729-354-52	TRANSISTOR 2SC2545-E	
< RESISTOR >			
R101	1-246-545-00	CARBON 1.0M 5% 1/4W	
R102	1-246-545-00	CARBON 1.0M 5% 1/4W	
R103	1-246-545-00	CARBON 1.0M 5% 1/4W	
R104	1-246-545-00	CARBON 1.0M 5% 1/4W	
R105	1-246-545-00	CARBON 1.0M 5% 1/4W	
R106	1-247-713-11	CARBON 1K 5% 1/4W	
R107	1-247-713-11	CARBON 1K 5% 1/4W	
R108	1-246-545-00	CARBON 1.0M 5% 1/4W	
R109	1-246-545-00	CARBON 1.0M 5% 1/4W	
R110	1-247-739-11	CARBON 100 5% 1/2W	

<p>Note: The components identified by mark △ or dotted line with mark △ are critical for safety. Replace only with part number specified.</p>	<p>Note: Les composants identifiés par une marque △ sont critiques pour la sécurité. Ne les remplacer que par une pièce portant le numéro spécifié.</p>
--	---

EQ **SP** **RELAY (J)** **A/B (J)** **VS (E)** **OUTLINE** **INPUT**

Ref. No.	Part No.	Description	Remark
R301	1-247-713-11	CARBON	1K 5% 1/4W
R302	1-249-469-11	CARBON	100K 5% 1/4W
R303	1-247-704-11	CARBON	220 5% 1/4W
R304	1-247-704-11	CARBON	220 5% 1/4W
R305	1-247-704-11	CARBON	220 5% 1/4W
R306	1-247-717-11	CARBON	2. 2K 5% 1/4W
R307	1-249-490-11	CARBON	27K 5% 1/2W
R308	1-247-704-11	CARBON	220 5% 1/4W
R309	1-247-721-11	CARBON	4. 7K 5% 1/4W
R310	1-249-516-11	CARBON	33 5% 1/4W
R311	1-247-700-11	CARBON	100 5% 1/4W
R332	1-247-727-11	CARBON	10 5% 1/2W (G)
R333	1-247-727-11	CARBON	10 5% 1/2W (G)
R326	1-249-721-11	CARBON	100K 5% 1/2W
R327	1-249-668-11	CARBON	620 5% 1/2W
R328	1-247-727-11	CARBON	10 5% 1/2W
R405	1-247-706-11	CARBON (EXCEPT G)	330 5% 1/4W
R406	1-247-700-11	CARBON	100 5% 1/4W
R407	1-249-469-11	CARBON	100K 5% 1/4W
R408	1-249-469-11	CARBON	100K 5% 1/4W
R409	1-247-710-11	CARBON	560 5% 1/4W
R410	1-247-710-11	CARBON	560 5% 1/4W
R411	1-247-725-11	CARBON	10K 5% 1/4W
R412	1-247-700-11	CARBON	100 5% 1/4W
R413	1-260-661-11	CARBON	6. 8 5% 1/4W
R414	1-247-138-00	CARBON	2K 5% 1/4W
R415	1-247-700-11	CARBON (EXCEPT G)	100 5% 1/4W
R415	1-249-542-11	CARBON	390 5% 1/4W (G)
R416	1-246-545-00	CARBON	1. 0M 5% 1/4W
R417	1-249-844-11	CARBON	56K 1% 1/2W
R418	1-249-818-11	CARBON	4. 7K 1% 1/2W
R419	1-247-713-11	CARBON	1K 5% 1/4W
R420	1-249-421-11	CARBON	2. 2K 5% 1/4W (G)
R421	1-249-421-11	CARBON	2. 2K 5% 1/4W (G)
R422	1-247-713-11	CARBON	1K 5% 1/4W
R423	1-247-713-11	CARBON	1K 5% 1/4W
R424	1-247-713-11	CARBON	1K 5% 1/4W
R425	1-247-713-11	CARBON	1K 5% 1/4W
R426	1-247-713-11	CARBON	1K 5% 1/4W
R427	1-247-713-11	CARBON	1K 5% 1/4W
R428	1-247-713-11	CARBON	1K 5% 1/4W
R429	1-247-713-11	CARBON	1K 5% 1/4W
R430	1-247-249-00	CARBON	2. 4K 5% 1/2W
R431	1-247-249-00	CARBON	2. 4K 5% 1/2W

Ref. No.	Part No.	Description	Remark
< RELAY >			
RY502	1-515-727-11	RELAY	
RY503	1-515-501-00	RELAY	
RY504	1-515-501-00	RELAY	
< SWITCH >			
S101	1-571-115-11	SWITCH, SLIDE (INPUT SELECTOR)	
S102	1-571-115-11	SWITCH, SLIDE (REC OUT SELECTOR)	
S401	1-571-111-11	SWITCH, PUSH (1 KEY) (CARTRIDGE)	
S601	△. 1-554-920-11	SWITCH, PUSH (AC POWER) (1 KEY) (POWER)	
< CONNECTOR >			
SE1	1-564-320-00	PIN, CONNECTOR 2P	
SE2	1-564-320-00	PIN, CONNECTOR 2P	
SE3	1-564-321-00	PIN, CONNECTOR 2P (E)	
SE4	1-564-321-00	PIN, CONNECTOR 2P (E)	
< TERMINAL >			
TM301	1-537-227-11	TERMINAL BOARD (SP) (SPEAKER) (AE2)	
TM301	1-537-228-11	TERMINAL BOARD (SP) (SPEAKER) (G)	
TM301	1-537-235-11	TERMINAL BOARD (SP) (SPEAKER) (Canadian, AE1, E)	
< CONNECTOR >			
VH9	* 1-564-321-00	PIN, CONNECTOR 2P	
VH10	* 1-564-321-21	PIN, CONNECTOR 2P (EXCEPT E)	
VH11	* 1-564-687-11	PIN, CONNECTOR 3P (Canadian)	
VH15	* 1-566-664-11	PIN, CONNECTOR 4P (E)	
VH16	* 1-568-226-11	PIN, CONNECTOR 2P (E)	
< SWITCH >			
VS1	△. 1-572-009-11	SELECTOR, VOLTAGE (VOLTAGE SELECTOR) (E)	

<p>Note: The components identified by mark △ or dot- ted line with mark △ are critical for safety. Replace only with part number specified.</p>	<p>Note: Les composants identifiés par une marque △ sont critiques pour la sécurité. Ne les remplacer que par une pièce portant le numéro spéci- fié.</p>
--	--

MAIN

TONE

VR

H. P

TONE (J)

MUT

MUT LED

POWER LED

VR J

Ref. No.	Part No.	Description	Remark
*	A-4345-377-A	MAIN BOARD, COMPLETE (Canadian, AE1, E)	
*	A-4345-378-A	MAIN BOARD, COMPLETE (AE2)	
*	A-4345-665-A	MAIN BOARD, COMPLETE (G)	

*	A-4345-379-A	TONE BOARD, COMPLETE (EXCEPT AE2)	
*	A-4345-380-A	TONE BOARD, COMPLETE (AE2)	

*	1-639-360-11	VR BOARD	

*	1-639-361-11	H. P BOARD	

*	1-639-362-11	TONE (J) BOARD	

*	1-639-363-11	MUT BOARD	

*	1-639-364-11	MUT LED BOARD	

*	1-639-365-11	POWER LED BOARD	

*	1-639-382-11	VR J BOARD	

*	4-942-408-01	SPACER (DIA. 30)	
< CAPACITOR >			
C201	1-106-363-00	MYLAR 6800PF	5% 200V
C202	1-130-489-00	MYLAR 0.033uF	5% 50V
C203	1-130-491-00	MYLAR 0.047uF	5% 50V
C204	1-136-171-00	FILM 0.33uF	5% 50V
C206	1-136-172-00	FILM 0.39uF	5% 50V
C312	1-126-051-11	ELECT 47uF	20% 50V
C313	1-102-233-00	CERAMIC 33PF	10% 500V
C314	1-102-233-00	CERAMIC 33PF	10% 500V
C315	1-130-487-00	MYLAR 0.022uF	5% 50V
(EXCEPT AE2)			
C315	1-130-491-00	MYLAR 0.047uF	5% 50V (AE2)
C316	1-130-491-00	MYLAR 0.047uF	5% 50V (AE2)
C501	1-125-695-11	ELECT 12000uF	20% 63V
C502	1-125-695-11	ELECT 12000uF	20% 63V
C503	1-125-694-11	ELECT 5600uF	20% 63V
C504	1-125-694-11	ELECT 5600uF	20% 63V
C508	1-136-880-11	FILM 2.2uF	10% 160V
C509	1-126-069-11	ELECT 1uF	20% 100V
C510	1-126-064-81	ELECT 220uF	20% 63V
C511	1-126-062-11	ELECT 47uF	20% 63V
C512	1-126-219-11	ELECT 3.3uF	20% 63V
C513	1-126-163-11	ELECT 4.7uF	20% 50V
C517	1-126-023-11	ELECT 100uF	20% 25V
C518	1-130-487-00	MYLAR 0.022uF	5% 50V
C519	1-126-023-11	ELECT 100uF	20% 25V
C520	1-130-471-00	MYLAR 0.001uF	5% 50V
C521	1-130-483-00	MYLAR 0.01uF	5% 50V

Ref. No.	Part No.	Description	Remark
C522	1-130-483-00	MYLAR 0.01uF	5% 50V
< CONNECTOR >			
CP1	* 1-568-202-11	PIN, CONNECTOR (PC BOARD)	10P
CP2	* 1-560-552-00	PIN, CONNECTOR	5P
CP4	* 1-568-202-11	PIN, CONNECTOR (PC BOARD)	10P
CP5	1-568-577-11	PIN, CONNECTOR (PC BOARD)	3P
CP11	* 1-560-531-00	PIN, CONNECTOR	5P
CS1	* 1-562-334-00	SOCKET, CONNECTOR	10P
CS2	* 1-562-334-00	SOCKET, CONNECTOR	10P
CS4	* 1-562-334-00	SOCKET, CONNECTOR	10P
CS6	* 1-563-106-11	CONNECTOR (SOCKET)	10P
CS7	* 1-565-835-11	SOCKET, CONNECTOR	3P
< DIODE >			
D307	8-719-912-20	DIODE	1SS120
D308	8-719-912-20	DIODE	1SS120
D309	8-719-912-20	DIODE	1SS120
D357	8-719-912-20	DIODE	1SS120
D358	8-719-912-20	DIODE	1SS120
D359	8-719-912-20	DIODE	1SS120
D501	8-719-230-02	DIODE	30DF2
D502	8-719-230-02	DIODE	30DF2
D503	8-719-230-02	DIODE	30DF2
D504	8-719-230-02	DIODE	30DF2
D505	8-719-200-82	DIODE	11ES2
D506	8-719-200-82	DIODE	11ES2
D507	8-719-200-82	DIODE	11ES2
D508	8-719-200-82	DIODE	11ES2
D509	8-719-200-82	DIODE	11ES2
D510	8-719-200-82	DIODE	11ES2
D511	8-719-200-82	DIODE	11ES2
D512	8-719-313-40	DIODE	SEL1516W
D513	8-719-912-20	DIODE	1SS120
D514	8-719-912-20	DIODE	1SS120
D517	8-719-912-20	DIODE	1SS120
D518	8-719-301-49	DIODE	SEL2810A
D519	8-719-301-49	DIODE	SEL2810A
D520	8-719-912-20	DIODE	1SS120
< CONNECTOR >			
DR4	* 1-564-339-61	PIN, CONNECTOR	5P
DR5	* 1-564-337-00	PIN, CONNECTOR	3P
EH1	* 1-564-506-11	PLUG, CONNECTOR	3P
< IC >			
IC501	8-759-111-68	IC	uPC1237HA

MAIN

TONE

VR

H. P

TONE (J)

MUT

MUT LED

POWER LED

VR J

Ref. No.	Part No.	Description	Remark
		< JACK >	
J301	1-507-796-71	JACK (HEADPHONES)	
		< TRANSISTOR >	
Q309	8-729-203-45	TRANSISTOR 2SC3423-0	
Q310	8-729-107-53	TRANSISTOR 2SC2275A-P	
Q311	8-729-141-10	TRANSISTOR 2SA985A-OP	
Q312	8-729-320-03	TRANSISTOR 2SC2921M-0	
Q313	8-729-320-01	TRANSISTOR 2SA1215M-0	
Q314	8-729-140-82	TRANSISTOR 2SA988-PAFAEA	
Q359	8-729-203-45	TRANSISTOR 2SC3423-0	
Q360	8-729-107-53	TRANSISTOR 2SC2275A-P	
Q361	8-729-141-10	TRANSISTOR 2SA985A-OP	
Q362	8-729-320-03	TRANSISTOR 2SC2921M-0	
Q363	8-729-320-01	TRANSISTOR 2SA1215M-0	
Q364	8-729-140-82	TRANSISTOR 2SA988-PAFAEA	
Q501	8-729-194-57	TRANSISTOR 2SC945-P	
Q502	8-729-141-03	TRANSISTOR 2SA733-OP	
Q503	8-729-141-03	TRANSISTOR 2SA733-OP	
Q504	8-729-140-96	TRANSISTOR 2SD774-34	
Q505	8-729-620-05	TRANSISTOR 2SC2603-EF	
Q506	8-729-620-05	TRANSISTOR 2SC2603-EF	
		< RESISTOR >	
R111	1-259-580-11	CARBON 11K 5%	1/2W
R201	1-247-721-11	CARBON 4.7K 5%	1/4W
R202	1-247-712-11	CARBON 820 5%	1/4W
R203	1-246-545-00	CARBON 1.0M 5%	1/4W
R204	1-247-716-11	CARBON 1.8K 5%	1/4W
R205	1-259-502-11	CARBON 4.7M 5%	1/4W
R206	1-259-502-11	CARBON 4.7M 5%	1/4W
R207	1-247-128-00	CARBON 750 5%	1/4W
R208	1-249-577-11	CARBON 11K 5%	1/4W
R209	1-247-138-00	CARBON 2K 5%	1/4W
R210	1-247-152-00	CARBON 8.2K 5%	1/4W
R211	1-259-580-11	CARBON 11K 5%	1/2W
R314	△. 1-247-713-11	CARBON 1K 5%	1/4W F
R315	1-247-707-11	CARBON 390 5%	1/4W
R316	△. 1-212-990-00	FUSIBLE 220 5%	1/2W F
R317	△. 1-212-950-00	FUSIBLE 4.7 5%	1/2W F
R318	△. 1-212-950-00	FUSIBLE 4.7 5%	1/2W F
R319	1-217-151-00	METAL PLATE 0.22	
R320	1-217-151-00	METAL PLATE 0.22	
R321	△. 1-247-721-11	CARBON 4.7K 5%	1/4W F
R322	1-249-460-11	CARBON 15K 5%	1/4W
R323	△. 1-212-962-00	FUSIBLE 15 5%	1/2W F
R324	△. 1-212-962-00	FUSIBLE 15 5%	1/2W F
R325	1-247-891-00	CARBON 330K 5%	1/4W

Ref. No.	Part No.	Description	Remark
R329	1-247-747-11	CARBON 470 5%	1/2W
R501	△. 1-212-849-00	FUSIBLE 4.7 5%	1/4W F
R502	1-247-721-11	CARBON 4.7K 5%	1/4W
R503	1-247-251-00	CARBON 3K 5%	1/2W
R504	1-247-251-00	CARBON 3K 5%	1/2W
R505	1-247-251-00	CARBON 3K 5%	1/2W
R506	1-247-251-00	CARBON 3K 5%	1/2W
R507	1-247-251-00	CARBON 3K 5%	1/2W
R508	1-247-251-00	CARBON 3K 5%	1/2W
R509	1-247-251-00	CARBON 3K 5%	1/2W
R510	1-247-725-11	CARBON 10K 5%	1/4W
R511	1-249-462-11	CARBON 22K 5%	1/4W
R512	1-249-465-11	CARBON 47K 5%	1/4W
R513	1-249-465-11	CARBON 47K 5%	1/4W
R515	1-247-706-11	CARBON 330 5%	1/4W
R516	1-247-706-11	CARBON 330 5%	1/4W
R517	1-247-249-00	CARBON 2.4K 5%	1/2W
R518	1-247-249-00	CARBON 2.4K 5%	1/2W
R519	1-247-092-00	CARBON 24 5%	1/4W
R520	1-247-721-11	CARBON 4.7K 5%	1/4W
R521	1-249-461-11	CARBON 18K 5%	1/4W
R522	1-247-881-00	CARBON 120K 5%	1/4W
R523	1-247-725-11	CARBON 10K 5%	1/4W
R524	1-247-887-00	CARBON 220K 5%	1/4W
R525	1-247-757-11	CARBON 2.7K 5%	1/2W
R526	1-247-757-11	CARBON 2.7K 5%	1/2W
R527	1-249-462-11	CARBON 22K 5%	1/4W
R529	1-247-742-11	CARBON 180 5%	1/2W
		(EXCEPT AE2)	
R529	1-247-211-00	CARBON 62 5%	1/2W (AE2)
R530	1-247-717-11	CARBON 2.2K 5%	1/4W
R531	1-247-251-00	CARBON 3K 5%	1/2W
R540	1-247-721-11	CARBON 4.7K 5%	1/4W
R541	1-247-721-11	CARBON 4.7K 5%	1/4W
R542	1-247-758-11	CARBON 3.3K 5%	1/2W
		(EXCEPT AE2)	
R542	1-247-757-11	CARBON 2.7K 5%	1/2W (AE2)
R543	1-247-758-11	CARBON 3.3K 5%	1/2W
		(EXCEPT AE2)	
R543	1-247-757-11	CARBON 2.7K 5%	1/2W (AE2)
		< VARIABLE RESISTOR >	
RT301	1-237-455-11	RES. ADJ. CARBON 500	
RT351	1-237-455-11	RES. ADJ. CARBON 500	
RV201	1-241-517-11	RES. VAR. CARBON 250K/250K (BALANCE)	
RV202	1-241-518-11	RES. VAR. CARBON 25K/100K (TREBLE)	
RV203	1-241-519-11	RES. VAR. CARBON 25K/250K (BASS)	
RV204	1-241-516-11	RES. VAR. CARBON 60K/60K (ATTENUATOR)	

Note:
The components identified by mark △ or dotted line with mark △ are critical for safety. Replace only with part number specified.

Note:
Les composants identifiés par une marque △ sont critiques pour la sécurité. Ne les remplacer que par une pièce portant le numéro spécifié.

MAIN

tone

VR

H. P

tone (J)

MUT

MUT LED

POWER LED

VR J

Ref. No.	Part No.	Description	Remark
		< RELAY >	
RY501	1-515-727-11	RELAY	
RY505	1-515-787-11	RELAY	
		< SWITCH >	
S201	1-572-738-11	SWITCH, PUSH (3 KEY) (SUBSONIC)	
S202	1-572-741-11	SWITCH, PUSH (1 KEY) (SOURCE DIRECT)	
S203	1-572-738-11	SWITCH, PUSH (3 KEY) (MODE)	
S204	1-572-738-11	SWITCH, PUSH (3 KEY) (DIRECT INPUT)	
S205	1-572-740-11	SWITCH, PUSH (1 KEY) (MUTING-20dB)	
S206	1-572-739-11	SWITCH, PUSH (2 KEY) (SPEAKER A)	
S207	1-572-739-11	SWITCH, PUSH (2 KEY) (SPEAKER B)	
S208	1-572-143-11	SWITCH, SLIDE (SOURCE DIRECT)	
		< CONNECTOR >	
VH1	* 1-564-241-00	PIN, CONNECTOR 4P	
VH2	1-564-320-00	PIN, CONNECTOR 2P	
VH5	* 1-564-241-00	PIN, CONNECTOR 4P	

MISCELLANEOUS

70	1-572-742-11	SWITCH, ROTARY	
71	1-572-743-11	SWITCH, ROTARY	
120	△. 1-574-805-11	CORD, POWER (AEP, G)	
121	1-535-706-11	PLUG, JUMPER	
126	△. 1-574-381-11	CORD, POWER (E)	
127	△. 1-575-975-11	CORD, POWER (Canadian)	
128	△. 1-526-565-00	AC PLUG ADAPTOR (E)	
T901	△. 1-450-500-11	TRANSFORMER, POWER (E)	
T901	△. 1-450-501-11	TRANSFORMER, POWER (AE2)	
T901	△. 1-450-502-11	TRANSFORMER, POWER (AE1, G)	
T901	△. 1-450-538-11	TRANSFORMER, POWER (Canadian)	

ACCESSORY & PACKING MATERIAL

3-753-600-11	MANUAL, INSTRUCTION (ENGLISH, FRENCH, SPANISH, PORTUGUESE) (Canadian, AE1, E)
3-753-600-41	MANUAL, INSTRUCTION (GERMAN, DUTCH, SWEDISH, ITALIAN) (AE1, AE2, G)
* 4-929-219-01	CUSHION
* 4-945-284-01	INDIVIDUAL CARTON (F570ES)
* 4-945-286-01	INDIVIDUAL CARTON (F222ESA)

Ref. No.	Part No.	Description	Remark
----------	----------	-------------	--------

HARDWARE LIST

#1	7-685-234-19	SCREW +KTP 2.6X8 TYPE2NON-SLIT	
#2	7-682-547-09	SCREW +BVTT 3X6 (S)	
#3	7-685-647-79	SCREW +BTP 3X10 TYPE2 N-S	
#4	7-685-650-79	SCREW +BVTP 3X16 TYPE2 SLIT	
#5	7-682-548-09	SCREW (3X8)	
#6	7-682-565-09	SCREW +B 4X16 (G)	
#6	7-682-566-09	SCREW +B 4X20 (Canadian, AEP, E)	
#7	7-684-024-04	N 4, TYPE 2	
#8	7-685-648-79	SCREW +BVTP 3X12 TYPE2 IT-3	
#9	7-685-876-09	SCREW +BVTT 3X16 (S)	
#10	7-621-849-00	SCREW, TAPPING (G)	

Note:
The components identified by mark △ or dotted line with mark △ are critical for safety. Replace only with part number specified.

Note:
Les composants identifiés par une marque △ sont critiques pour la sécurité. Ne les remplacer que par une pièce portant le numéro spécifié.