

TA-N511/N611

SERVICE MANUAL

US Model
TA-N511/N611

Canadian Model
E Model
Australian Model
TA-N511

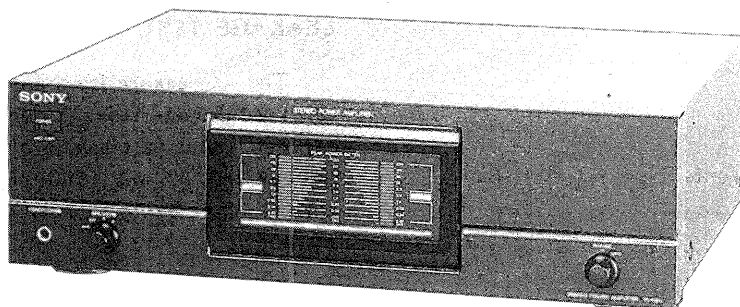

Photo : TA-N511

SPECIFICATIONS

AUDIO POWER SPECIFICATIONS

POWER OUTPUT AND TOTAL HARMONIC DISTORTION:

With 8-ohm loads, both channels driven, from 20 - 20,000 Hz; rated 135 watts (TA-N511) or 150 watts (TA-N611) per channel minimum RMS power, with less than 0.9% total harmonic distortion from 250 milliwatts to rated output.

Amplifier section

Power bandwidth (IHF)

7 Hz - 30 kHz (8 ohms)

Overall output (1 kHz, 8-ohm load)

TA-N511: 135 W + 135 W (front)

15 W + 15 W (rear)

TA-N611: 150 W + 150 W (front)

15 W + 15 W (rear/DRLC)

Harmonic distortion

TA-N511: Less than 0.9% (at 1 kHz, 8-ohm load, front: 135 W + 135 W, rear: off)

TA-N611: Less than 0.9% (at 1 kHz, 8-ohm load, front: 150 W + 150 W, rear/DRLC: off)

Intermodulation (IM) distortion (60 Hz : 7 kHz)

Less than 0.9% at rated output

Frequency response

INPUT (FRONT/REAR): 10 Hz - 70 kHz \pm 3 dB

Input sensitivity 1 V (50 kohms)
Damping factor 40 (8 ohms, 1 kHz)
Signal-to-noise ratio

115 dB

Output

FRONT SPEAKER, REAR SPEAKER, and DRLC SPEAKER (TA-N611 only):
Accepts speakers of 8 - 16 ohms.
HEADPHONES: Accepts low and high impedance headphones.

General

Power requirements

TA-N511/N611 : 120V AC, 60Hz (US)

TA-N511 : 120V AC, 60Hz (Canadian)

TA-N511 : 220V AC, 50/60Hz (Australian)

TA-N511 : 120V, 220V, 240V

AC, 50/60Hz (E)

Power consumption

TA-N511: 230 W

TA-N611: 250 W

Dimensions

Approx. 430 x 130 x 345 mm (w/h/d)
(17 x 5 $\frac{1}{8}$ x 13 $\frac{3}{4}$ inches)

Weight

TA-N511: Approx. 9.1 kg (20 lb 1 oz)
TA-N611: Approx. 10.0 kg (22 lb 1 oz)

Design and specifications subject to change without notice.

STEREO POWER AMPLIFIER
SONY®

TABLE OF CONTENTS

Section	Title	Page
Specifications		1
Model Identification		2
1. GENERAL		3
2. ADJUSTMENTS		5
3. DIAGRAMS		
3-1. Semiconductor Lead Layouts		6
3-2. IC Block Diagram		6
3-3. Printed Wiring Boards		7
3-4. Schematic Diagram		11
4. EXPLODED VIEWS		14
5. ELECTRICAL PARTS LIST		16

MODEL IDENTIFICATION

- Specification Labels -

TA-N511
TA-N611

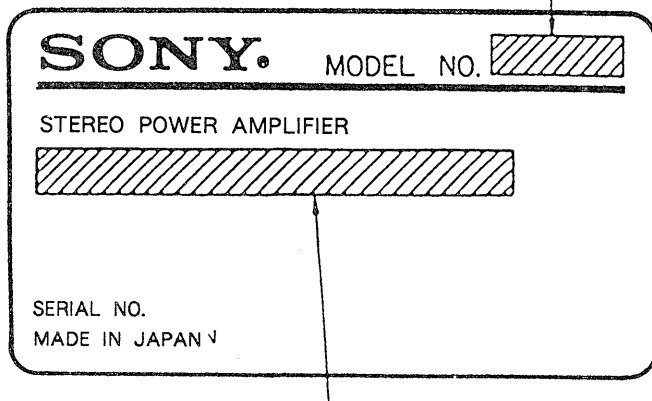

US, Canadian models : 120V AC, 60Hz
 Australian model : 220V AC, 50/60Hz
 E model : 120V, 220V, 240V AC, 50/60Hz

SAFETY-RELATED COMPONENT WARNING!!

COMPONENTS IDENTIFIED BY MARK Δ OR DOTTED LINE WITH MARK Δ ON THE SCHEMATIC DIAGRAMS AND IN THE PARTS LIST ARE CRITICAL TO SAFE OPERATION. REPLACE THESE COMPONENTS WITH SONY PARTS WHOSE PART NUMBERS APPEAR AS SHOWN IN THIS MANUAL OR IN SUPPLEMENTS PUBLISHED BY SONY.

SAFETY CHECK-OUT

After correcting the original service problem, perform the following safety check before releasing the set to the customer:

Check the antenna terminals, metal trim, "metallized" knobs, screws, and all other exposed metal parts for AC leakage. Check leakage as described below.

LEAKAGE TEST

The AC leakage from any exposed metal part to earth ground and from all exposed metal parts to any exposed metal part having a return to chassis, must not exceed 0.5 mA (500 microampers). Leakage current can be measured by any one of three methods.

1. A commercial leakage tester, such as the Simpson 229 or RCA WT-540A. Follow the manufacturers' instructions to use these instruments.
2. A battery-operated AC milliammeter. The Data Precision 245 digital multimeter is suitable for this job.
3. Measuring the voltage drop across a resistor by means of a VOM or battery-operated AC voltmeter. The "limit" indication is 0.75 V, so analog meters must have an accurate low-voltage scale. The Simpson 250 and Sanwa SH-63Trd are examples of a passive VOM that is suitable. Nearly all battery operated digital multimeters that have a 2V AC range are suitable. (See Fig. A)

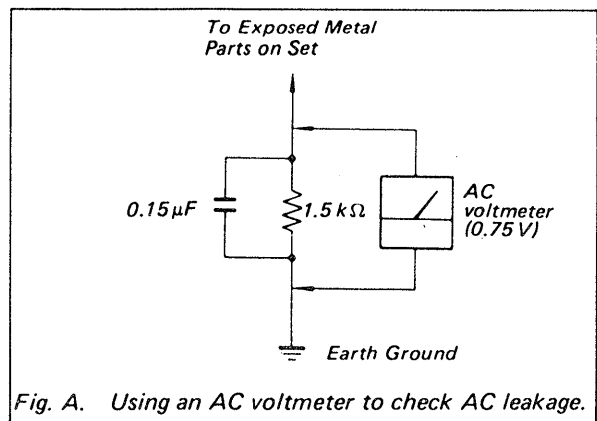

Fig. A. Using an AC voltmeter to check AC leakage.

ATTENTION AU COMPOSANT AYANT RAPPORT À LA SÉCURITÉ!

LES COMPOSANTS IDENTIFIÉS PAR UNE MARQUE Δ SUR LES DIAGRAMMES SCHÉMATIQUES ET LA LISTE DES PIÈCES SONT CRITIQUES POUR LA SÉCURITÉ DE FONCTIONNEMENT. NE REMPLACER CES COMPOSANTS QUE PAR DES PIÈCES SONY DONT LES NUMÉROS SONT DONNÉS DANS CE MANUEL OU DANS LES SUPPLÉMENTS PUBLIÉS PAR SONY.

Connections for Dual Room Link Control Kit and Speakers (TA-N611 only)

The DRLC (Dual Room Link Control) allows you to "link" a second room to your main or primary listening room. When the Dual Room Link Control Kit RM-S2020K or RM-S2070K (optional) and optional speakers are connected to your audio system and they are placed in the second room, either the same program source being played in the main room or a different program source can be heard in the second room.

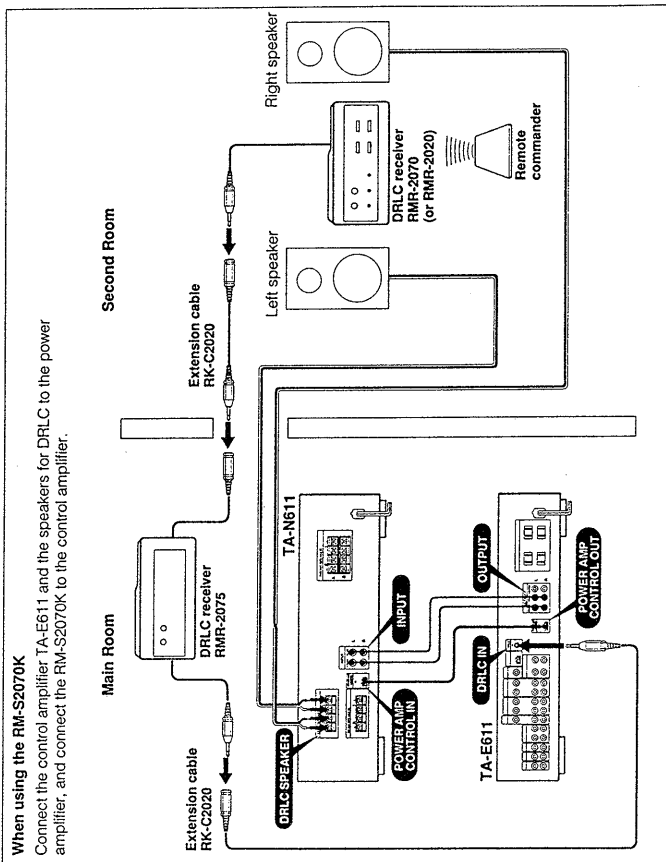

- Notes**
- To select surround mode or DRLC function, be sure to connect POWER AMP CONTROL jacks.
 - The surround system in the main room and DRLC function cannot be operated simultaneously.

For details, refer to the operating instructions of TA-E611 and RM-S2020K or RM-S2070K.

Function of Controls

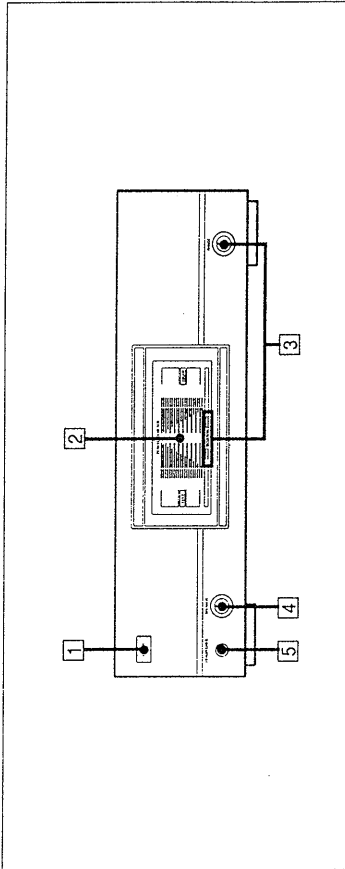

1 POWER switch

Press to turn ON or OFF the unit. To control the power of the unit with the power switch (SYSTEM POWER) of the control amplifier, connect the power cord of the unit to the switched AC outlet of the control amplifier and usually set the POWER switch of the unit to ON.

2 PEAK POWER METERS

Indicate the peak power levels of the LEFT and RIGHT channels independently.

3 RANGE selector and indicator

Select the range of the PEAK POWER METERS:
x1: Peak power level is indicated by the scales (for use when listening at the high volume level).
x1/10: Peak power level is indicated by 1/10 of the scales (for use when listening at the low volume level).

4 SPEAKERS selector

Select the speaker system to be used.
A: To drive speaker system A.
B: To drive speaker system B.
A+B: To drive both speaker systems A and B.
OFF: For headphones listening only.

Notes

- Speaker systems A and B are series connected. No sound can be heard if the SPEAKERS selector is set to A+B when only one speaker system is connected.
- The sound of the rear (surround) or DRLC (Dual Room Link Control) speakers can be heard only when surround mode or DRLC is selected on the control amplifier or DRLC units.

5 HEADPHONES jack (stereo phone jack)

Connect headphones for listening the sound of front speakers.

Notes

- After setting the volume level to minimum on the control amplifier, connect headphones.
- The sound of rear and DRLC speakers cannot be heard from headphones.

SECTION 1 GENERAL

This section is extracted from instruction manual.

Connections

- Connect the AC power cord last. Make sure power is off.
- Cord plugs and jacks are color coded. Red plugs and jacks are for right channel (R) and white ones for the left channel (L).
- The cable connectors should be fully inserted into the jacks. A loose connection may cause hum and noise.
- The + and - cords of the speaker systems should be correctly connected to the + and - terminals of the amplifier respectively.

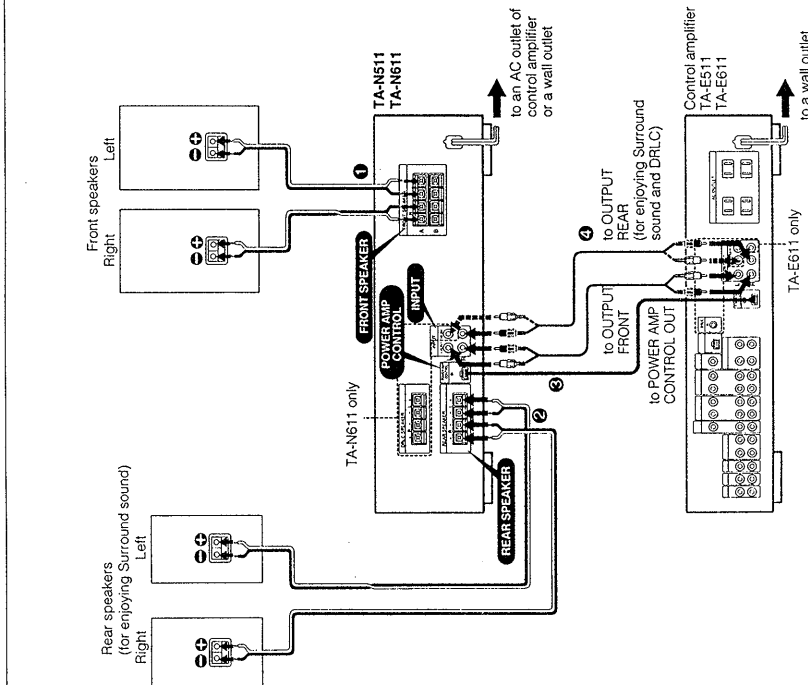

1 Front speaker cords

You can connect two pairs of speaker systems: system A and system B. They can be selected individually or simultaneously with the selector on the front panel.

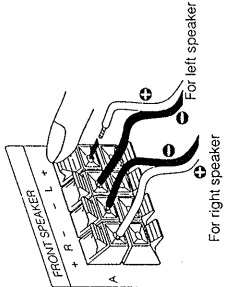

2 Rear speaker cords

Connect a pair of rear speaker systems for enjoying surround sound.

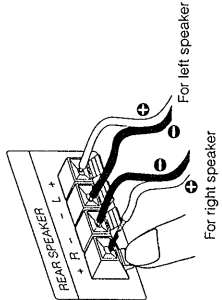

3 Power amplifier control cord (not supplied)

Connect to the POWER AMP CONTROL OUT jack of the AV control amplifier TA-E511 or TA-E611 with the control cord.

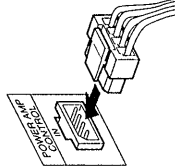

To disconnect.

4 Audio connection cords

TA-N511 has one REAR INPUT terminal for rear speakers. Connect to the REAR OUTPUT terminal of TA-E511 with a monaural connection cord. TA-N611 has left and right REAR INPUT terminals. Connect to the left and right REAR OUTPUT terminals of TA-E611 with a stereo connection cord respectively.

SECTION 2 ELECTRICAL ADJUSTMENTS

ELECTRICAL ADJUSTMENTS

Note :

1. DC BIAS adjustments should be made four minutes after the POWER switch is turned on (POWER ON).
2. After replacing the power transistors, DC BIAS adjustments should be made.

DC Bias Adjustment (with no signal input)

Procedure :

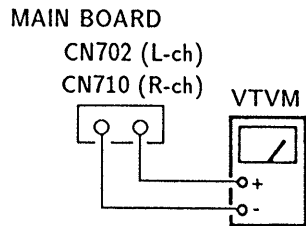

	Adjustment part	Reading on VTVM	
		TA-N511 : US, Canadian	TA-N511 : E, Australian TA-N611
L ch	RV701	3mV	6.6mV
R ch	RV751	3mV	6.6mV

【MAIN BOARD】

— COMPONENT SIDE —

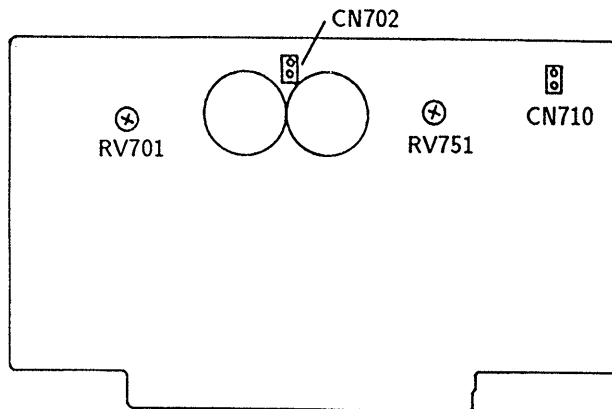

SECTION 3 DIAGRAMS

3-1. SEMICONDUCTOR LEAD LAYOUTS

2SD2012
2SA1215
2SC2921

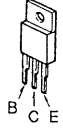

2SC2603
2SA1175
DTA124

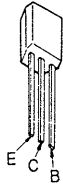

2SC4431
2SA1684

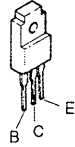

SEL2210R

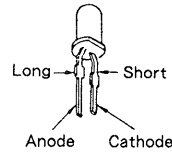

2SC4387
2SA1672

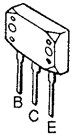

2SA979

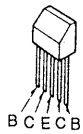

D300



IR2E31A

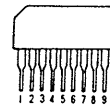

2SC1841
2SA988

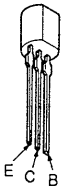

2SA1142
2SC2682

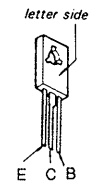

RBA-402

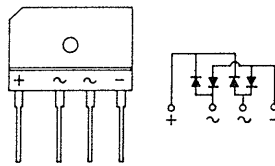

SI-18752N

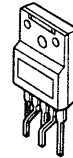

1S120
1S1585
10E2

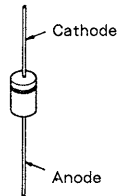

3-2. IC BLOCK DIAGRAMS

IC101, 102, 152, 151,
IR2E31A

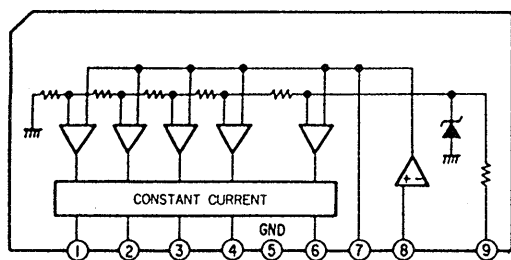

IC751
 μ PC1237HA

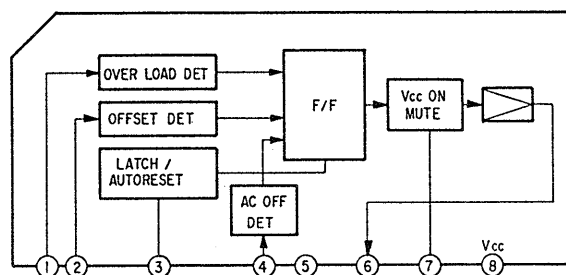

3-3-PRINTED WIRING BOARDS

• Semiconductor Location

Ref. No.	Location	Ref. No.	Location
D101	H-18	Q705	A-10
D102	H-18	Q706	B-9
D103	H-18	Q707	B-12
D104	H-18	Q708	B-10
D105	H-18	Q709	B-11
D106	G-18	Q710	B-10
D107	G-18	Q711	B-11
D108	G-18	Q712	A-9
D109	G-18	Q713	A-12
D110	H-18	Q714	A-9
D151	H-21	Q715	A-11
D152	H-21	Q716	B-12
D153	H-21	Q717	D-5
D154	H-21	Q718	D-5
D155	H-21	Q719	D-5
D156	G-21	Q751	C-4
D157	G-21	Q752	C-4
D158	G-21	Q753	C-4
D159	G-21	Q754	B-4
D160	H-21	Q755	A-5
D161	I-20	Q756	B-3
D162	I-19	Q757	C-6
D601	D-7	Q758	B-5
D602	F-7	Q759	B-5
D603	E-6	Q760	B-4
D604	E-12	Q761	B-6
D605	F-4	Q762	A-4
D606	G-11	Q763	A-7
D607	F-4	Q764	A-4
D608	F-10	Q765	A-6
D609	E-7	Q766	C-6
D610	D-7	Q767	D-12
D701	C-11	Q768	D-11
D702	C-9	Q769	D-11
D703	B-12		
D704	C-12		
D705	F-3		
D705B	F-3		
D706	F-4		
D707	F-12		
D751	C-4		
D752	C-4		
D753	C-6		
D754	D-6		
D755	D-11		
D756	D-10		
D756B	D-10		
D757	D-10		
IC101	H-19		
IC102	G-19		
IC151	H-20		
IC152	G-20		
IC601	G-8		
IC602	G-8		
IC751	D-11		
Q601	E-12		
Q602	G-3		
Q603	F-11		
Q701	C-9		
Q702	C-10		
Q703	C-11		
Q704	B-9		

Note on Mounting Diagram:
 • : Pattern on the side which is seen.

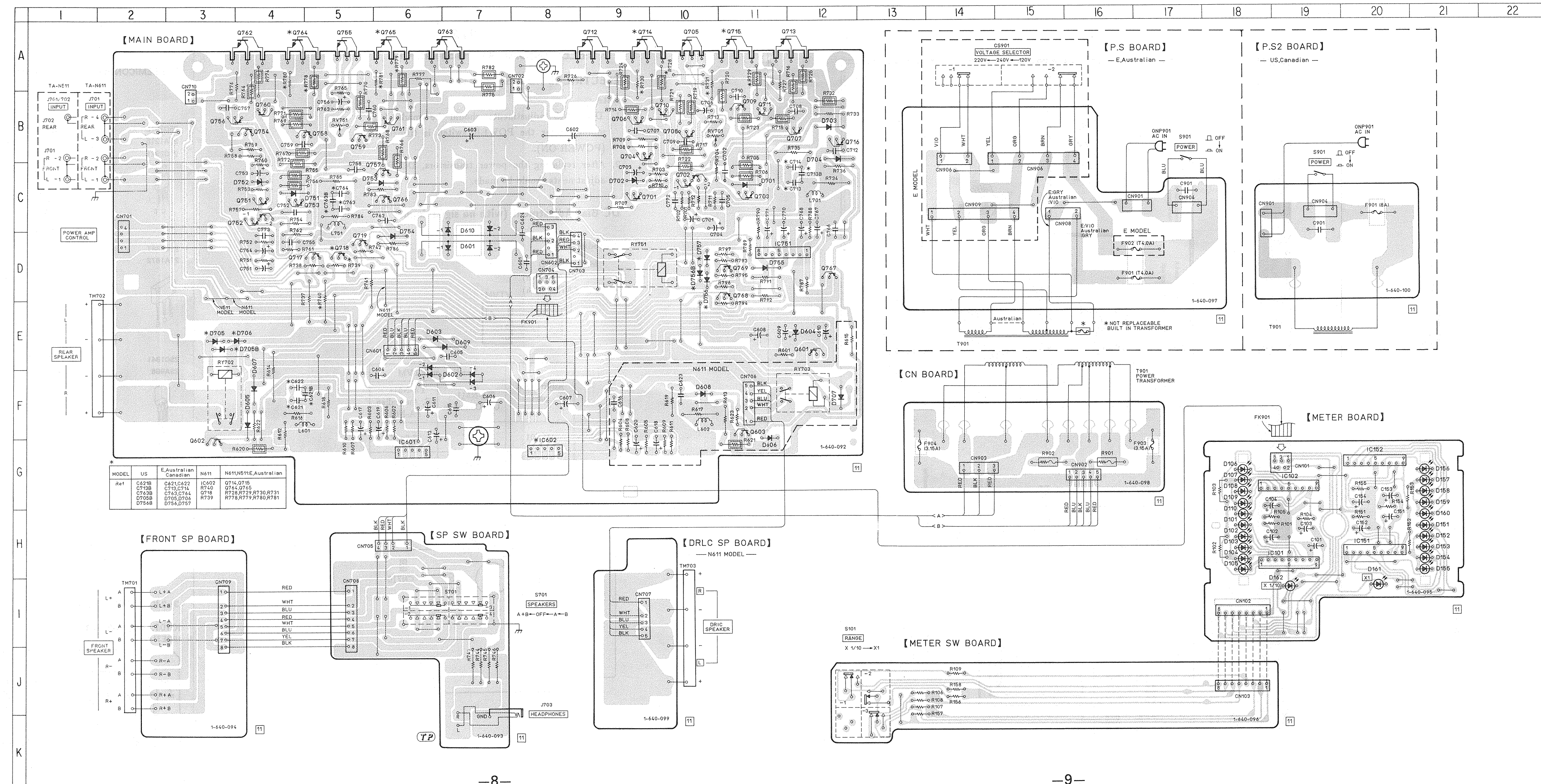

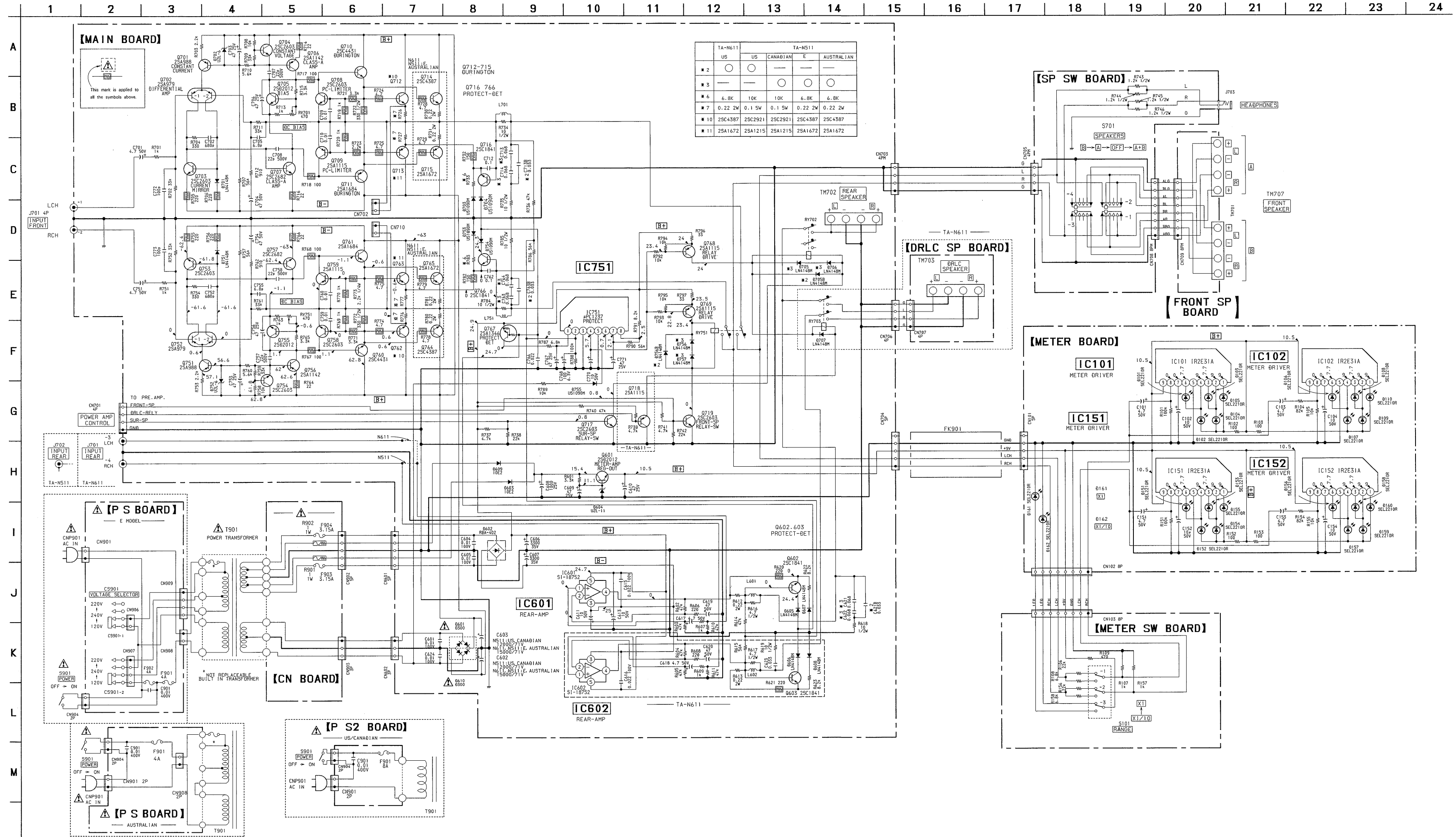

	TA-N611		TA-N511	
	US	CANADIAN	E	AUSTRALIAN
# 2	○	○	○	○
# 3	—	—	—	—
# 6	6.8K	10K	10K	6.8K
# 7	0.22 2W	0.1 5W	0.1 5W	0.22 2W
# 10	25C4387	25C2921	25C2921	25C4387
# 11	25A1672	25A1215	25A1215	25A1672

Note on Schematic Diagram:

- All capacitors are in μF unless otherwise noted. pF : μF 50WV or less are not indicated except for electrolytics and tantalums.
- All resistors are in Ω and $1/4\text{W}$ or less unless otherwise specified.
- : nonflammable resistor.
- : fusible resistor.

Note:
The components identified by mark or dotted line with mark are critical for safety. Replace only with part number specified.

Note:
Les composants identifiés par une marque sont critiques pour la sécurité. Ne les remplacer que par une pièce portant le numéro spécifié.

- **B+** : B+ Line
- **B-** : B- Line
- : adjustment for repair.
- Voltage and waveforms are dc with respect to ground under no-signal (detuned) conditions.
- Voltages are taken with a VOM (input impedance 10M Ω) Voltage variations may be noted due to normal production tolerances.

SECTION 4 EXPLODED VIEWS

NOTE :

- - XX, - X mean standardized parts, so they may have some differences from the original one.
- Color Indication of Appearance Parts
Example :
KNOB, BALANCE (WHITE)...(RED)
 ↑ ↑
Parts color Cabinet's color

- Items marked "*" are not stocked since they are seldom required for routine service. Some delay should be anticipated when ordering these items.
- The mechanical parts with no reference number in the exploded views are not supplied.
- Hardware (# mark) list is given in the last of this parts list.

The components identified by mark or dotted line with mark are critical for safety. Replace only with part number specified.

Les composants identifiés par une marque sont critiques pour la sécurité. Ne les remplacer que par une pièce portant le numéro spécifié.

OVERALL SECTION

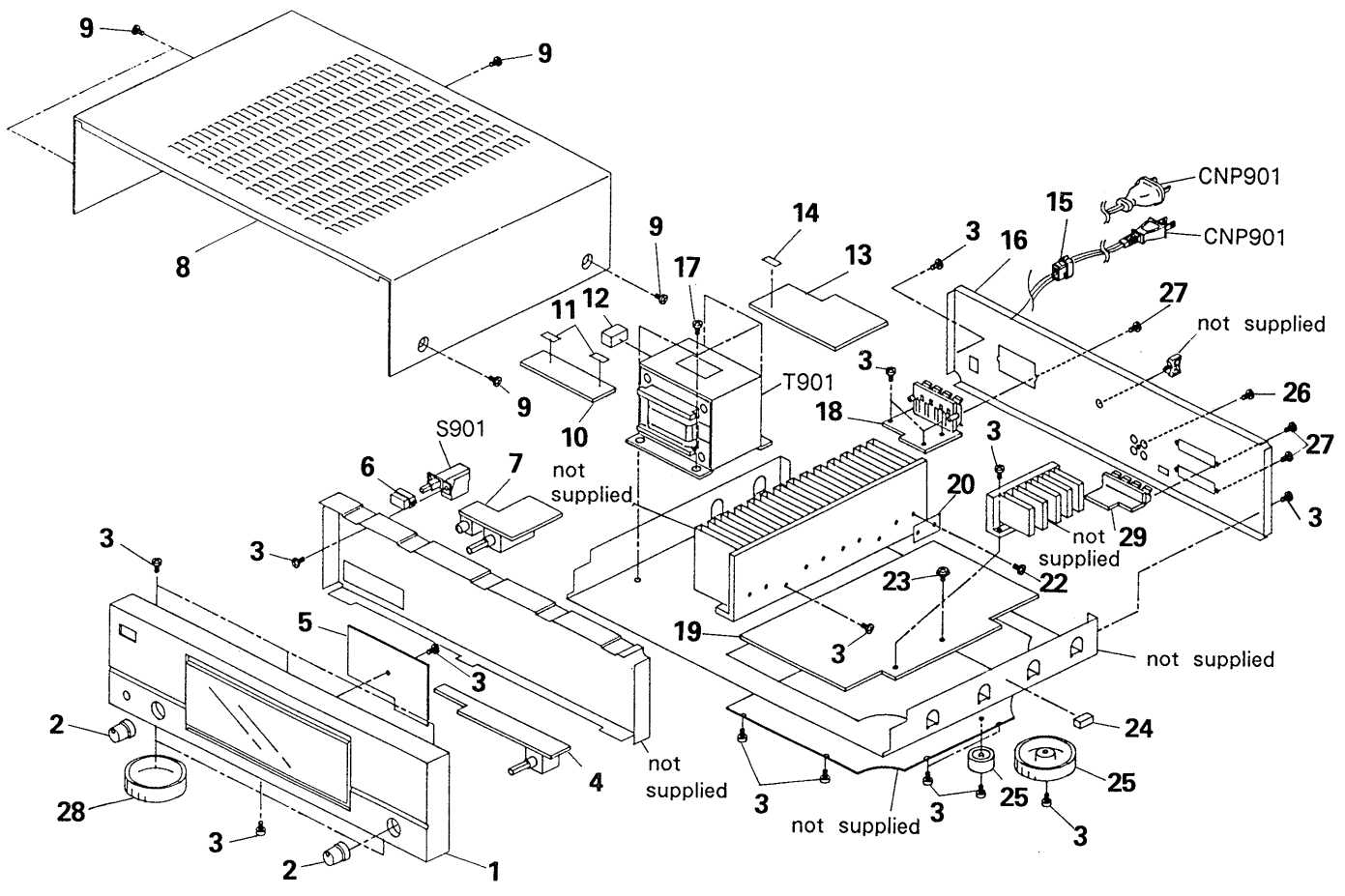

Ref. No.	Part No.	Description	Remark
1	X-4941-705-1	PANEL ASSY, FRONT (N611)	
1	X-4941-706-1	PANEL ASSY, FRONT (N511:US)	
1	X-4941-707-1	PANEL ASSY, FRONT (N511:Canadian)	
1	X-4941-708-1	PANEL ASSY, FRONT (N511:E, AUS)	
2	4-943-420-11	KNOB (DIA. 19)	
3	7-682-548-09	SCREW +B 3X8	
4	* 1-640-096-11	METER SW BOARD	
5	* A-4345-150-A	METER BOARD, COMPLETE	
6	3-354-912-01	KNOB, POWER	
7	* 1-640-093-11	SP SW BOARD	
8	* 4-924-920-71	CASE	
9	3-704-366-01	SCREW (CASE) (M3X8)	
10	* 1-640-098-11	CN BOARD	
11	△ 3-701-947-16	LABEL (T3.15A), FUSE (N511:E)	
12	* 3-720-698-01	SPACER (SMALL), NA	
13	* 1-640-100-11	P. S2 BOARD (N511:US, Canadian/N611)	
13	* 1-640-097-11	P. S BOARD (N511:E, AUS)	
14	△ 3-701-947-18	LABEL (T4A), FUSE (N511:E)	
15	* 3-703-244-00	BUSHING (2104), CORD (N511:US, Canadian, AUS/N611)	
15	* 3-703-571-11	BUSHING (S) (4516), CORD (N511:E)	
16	* 4-945-754-01	PANEL, BACK (N611)	
16	* 4-945-754-11	PANEL, BACK (N511:US)	
16	* 4-945-754-21	PANEL, BACK (N511:Canadian)	
16	* 4-945-754-31	PANEL, BACK (N511:E)	
16	* 4-945-754-41	PANEL, BACK (N511:AUS)	

Ref. No.	Part No.	Description	Remark
17	7-682-561-04	SCREW +BVTT 4X8 (S)	
18	* 1-640-094-11	FRONT SP BOARD	
19	* A-4345-118-A	MAIN BOARD, COMPLETE (N511:US)	
19	* A-4345-119-A	MAIN BOARD, COMPLETE (N511:Canadian)	
19	* A-4345-120-A	MAIN BOARD, COMPLETE (N511:E, AUS)	
19	* A-4345-146-A	MAIN BOARD, COMPLETE (N611)	
20	4-885-901-31	SHEET, RADIATION (N511:US, Canadian)	
22	7-682-549-09	SCREW +B 3X10 (N511:US, Canadian)	
23	4-886-821-11	SCREW, S TIGHT, +PTTWH 3X6	
24	9-911-840-XX	CUSHION	
25	4-933-601-01	FOOT (N511:US, E, AUS/N611)	
25	X-4885-950-1	FOOT ASSY (N511:Canadian)	
25	4-923-836-11	CUSHION (FOR FOOT ASSY) (N511:Canadian)	
26	7-621-849-00	SCREW, TAPPING	
27	7-685-646-79	SCREW +BVTP 3X8 TYPE2 N-S	
28	* 4-929-030-11	RING (DIA. 58A), ORNAMENTAL (N511:E, AUS)	
29	* 1-640-099-11	DRLC SP BOARD (N611)	
CNP901	△ 1-574-902-11	CORD, POWER (N511:E)	
CNP901	△ 1-590-083-11	CORD, POWER (N511:AUS)	
CNP901	△ 1-590-771-11	CORD, POWER (N511:US, Canadian/N611)	
S901	△ 1-554-538-00	SWITCH, PUSH (AC POWER) (1 KEY)	
T901	△ 1-450-599-11	TRANSFORMER, POWER (N611)	
T901	△ 1-450-600-11	TRANSFORMER, POWER (N511:US, Canadian)	
T901	△ 1-450-601-11	TRANSFORMER, POWER (N511:E, AUS)	

Note:
The components identified by mark △ or dotted line with mark △ are critical for safety. Replace only with part number specified.

Note:
Les composants identifiés par une marque △ sont critiques pour la sécurité. Ne les remplacer que par une pièce portant le numéro spécifié.

NOTE:

The components identified by mark Δ or dotted line with mark Δ are critical for safety. Replace only with part number specified.

Les composants identifiés par une marque Δ sont critiques pour la sécurité. Ne les remplacer que par une pièce portant le numéro spécifié.

When indicating parts by reference number, please include the board name.

- Due to standardization, replacements in the parts list may be different from the parts specified in the diagrams or the components used on the set.
- -XX, -X mean standardized parts, so they may have some difference from the original one.
- RESISTORS
All resistors are in ohms.
METAL: metal-film resistor
METAL OXIDE: Metal Oxide-film resistor
F: nonflammable
- Items marked "*" are not stocked since they are seldom required for routine service. Some delay should be anticipated when ordering these items.
- SEMICONDUCTORS
In each case, u: μ , for example:
uA...: μ A..., uPA..., μ PA...,
uPB..., μ PB..., uPC..., μ PC...,
uPD..., μ PD...
- CAPACITORS:
uF: μ F
- COILS
uH: μ H

Ref.No.	Part No.	Description	Remark	Ref.No.	Part No.	Description	Remark
*	A-4345-118-A	MAIN BOARD, COMPLETE (N511:US) *****		C602	1-125-430-11	ELECT (BLOCK) 15000uF 20% 71V (N511:E, AUS/N611)	
*	A-4345-119-A	MAIN BOARD, COMPLETE (N511:Canadian) *****		C602	1-125-573-11	ELECT (BLOCK) 12000uF 20% 71V (N511:US, Canadian)	
*	A-4345-120-A	MAIN BOARD, COMPLETE (N511:E, AUS) *****		C603	1-125-430-11	ELECT (BLOCK) 15000uF 20% 71V (N511:E, AUS/N611)	
*	A-4345-146-A	MAIN BOARD, COMPLETE (N611) *****		C603	1-125-573-11	ELECT (BLOCK) 12000uF 20% 71V (N511:US, Canadian)	
*	1-640-093-11	SP SW BOARD *****		C604	1-106-367-00	MYLAR 0.01uF 5% 200V	
*	1-640-094-11	FRONT SP BOARD *****		C605	1-106-367-00	MYLAR 0.01uF 5% 200V	
*	1-640-096-11	METER SW BOARD *****		C606	1-126-860-11	ELECT 3300uF 20% 35V	
*	1-640-097-11	P. S BOARD (N511:E, AUS) *****		C607	1-126-860-11	ELECT 3300uF 20% 35V	
*	1-640-098-11	CN BOARD *****		C608	1-124-557-11	ELECT 1000uF 20% 25V	
*	1-640-099-11	DRLC SP BOARD (N611) *****		C609	1-124-477-11	ELECT 47uF 20% 25V	
*	1-640-100-11	P. S2 BOARD (N511:US, Canadian/N611) *****		C610	1-124-477-11	ELECT 47uF 20% 25V	
Δ	1-533-225-11	HOLDER, FUSE		C611	1-124-907-11	ELECT 10uF 20% 50V	
*	4-942-204-01	PLATE, GROUND		C613	1-124-907-11	ELECT 10uF 20% 50V	
*	4-945-829-01	HOLDER, LED		C615	1-106-375-12	MYLAR 0.022uF 5% 200V	
	7-682-548-09	SCREW +B 3X8		C616	1-106-375-12	MYLAR 0.022uF 5% 200V (N611)	
	< CAPACITOR >			C617	1-124-927-11	ELECT 4.7uF 20% 100V	
C101	1-126-163-11	ELECT 4.7uF 20% 50V		C618	1-124-927-11	ELECT 4.7uF 20% 100V (N611)	
C102	1-124-261-00	ELECT 10uF 20% 50V		C619	1-124-910-11	ELECT 47uF 20% 50V	
C103	1-126-163-11	ELECT 4.7uF 20% 50V		C620	1-124-910-11	ELECT 47uF 20% 50V (N611)	
C104	1-124-261-00	ELECT 10uF 20% 50V		C621B	1-130-489-00	MYLAR 0.033uF 5% 50V (US)	
C151	1-126-163-11	ELECT 4.7uF 20% 50V		C621	1-130-493-00	MYLAR 0.068uF 5% 50V (N511:Canadian, E, AUS)	
C152	1-124-261-00	ELECT 10uF 20% 50V		C622	1-130-493-00	MYLAR 0.068uF 5% 50V (N511:Canadian, E, AUS)	
C153	1-126-163-11	ELECT 4.7uF 20% 50V		C623	1-130-489-00	MYLAR 0.033uF 5% 50V (N611)	
C154	1-124-261-00	ELECT 10uF 20% 50V		C624	1-106-367-00	MYLAR 0.01uF 5% 200V	
C601	1-106-367-00	MYLAR 0.01uF 5% 200V		C701	1-124-927-11	ELECT 4.7uF 20% 100V	

MAIN	SP SW	FRONT SP	METER SW	P.S	CN	DRLC SP	P.S2
------	-------	----------	----------	-----	----	---------	------

Ref. No.	Part No.	Description	Remark	Ref. No.	Part No.	Description	Remark
C702	1-162-292-31	CERAMIC	680PF 10% 50V	CN710	* 1-560-530-00	PIN, CONNECTOR 2P	
C703	1-126-750-91	ELECT	47uF 20% 25V	CN901	* 1 1-564-321-00	PIN, CONNECTOR 2P	
C704	1-124-910-11	ELECT	47uF 20% 50V	CN904	* 1 1-564-321-21	PIN, CONNECTOR 2P	
C705	1-162-197-31	CERAMIC	6.8PF 10% 50V	CN906	* 1 1-535-139-00	BASE POST 19MM (10MM PITCH) 2P	(N511:E)
C706	1-126-750-91	ELECT	47uF 20% 25V				
C707	1 1-161-959-00	CERAMIC	22PF 10% 500V	CN907	* 1 1-535-141-00	BASE POST 19MM (10MM PITCH) 4P	(N511:E)
C708	1 1-161-959-00	CERAMIC	22PF 10% 500V				
C709	1-130-483-00	MYLAR	0.01uF 5% 50V	CN908	* 1 1-535-139-00	BASE POST 19MM (10MM PITCH) 2P	(N511:E)
C710	1-130-483-00	MYLAR	0.01uF 5% 50V				
C712	1-130-495-00	MYLAR	0.1uF 5% 50V	CN909	* 1 1-535-141-00	BASE POST 19MM (10MM PITCH) 4P	(N511:E)
C713B	1-130-489-00	MYLAR	0.033uF 5% 50V (US)				
C713	1-130-493-00	MYLAR	0.068uF 5% 50V (N511:Canadian, E. AUS)			< DIODE >	
C714	1-130-493-00	MYLAR	0.068uF 5% 50V (N511:Canadian, E. AUS)	D101	8-719-304-80	DIODE SEL2210R-D-TP	
C751	1-124-927-11	ELECT	4.7uF 20% 100V	D102	8-719-304-80	DIODE SEL2210R-D-TP	
C752	1-162-292-31	CERAMIC	680PF 10% 50V	D103	8-719-304-80	DIODE SEL2210R-D-TP	
C753	1-126-750-91	ELECT	47uF 20% 25V	D104	8-719-304-80	DIODE SEL2210R-D-TP	
C754	1-124-910-11	ELECT	47uF 20% 50V	D105	8-719-304-80	DIODE SEL2210R-D-TP	
C755	1-162-197-31	CERAMIC	6.8PF 10% 50V	D106	8-719-304-80	DIODE SEL2210R-D-TP	
C756	1-126-750-91	ELECT	47uF 20% 25V	D107	8-719-304-80	DIODE SEL2210R-D-TP	
C757	1 1-161-959-00	CERAMIC	22PF 10% 500V	D108	8-719-304-80	DIODE SEL2210R-D-TP	
C758	1 1-161-959-00	CERAMIC	22PF 10% 500V	D109	8-719-304-80	DIODE SEL2210R-D-TP	
C759	1-130-483-00	MYLAR	0.01uF 5% 50V	D110	8-719-304-80	DIODE SEL2210R-D-TP	
C760	1-130-483-00	MYLAR	0.01uF 5% 50V	D151	8-719-304-80	DIODE SEL2210R-D-TP	
C762	1-130-495-00	MYLAR	0.1uF 5% 50V	D152	8-719-304-80	DIODE SEL2210R-D-TP	
C763B	1-130-489-00	MYLAR	0.033uF 5% 50V (US)	D153	8-719-304-80	DIODE SEL2210R-D-TP	
C763	1-130-493-00	MYLAR	0.068uF 5% 50V (N511:Canadian, E. AUS)	D154	8-719-304-80	DIODE SEL2210R-D-TP	
C764	1-130-493-00	MYLAR	0.068uF 5% 50V (N511:Canadian, E. AUS)	D155	8-719-304-80	DIODE SEL2210R-D-TP	
C766	1-161-494-00	CERAMIC	0.022uF 25V	D156	8-719-304-80	DIODE SEL2210R-D-TP	
C767	1-124-477-11	ELECT	47uF 20% 25V	D157	8-719-304-80	DIODE SEL2210R-D-TP	
C768	1-124-443-00	ELECT	100uF 20% 10V	D158	8-719-304-80	DIODE SEL2210R-D-TP	
C770	1-124-907-11	ELECT	10uF 20% 50V	D159	8-719-304-80	DIODE SEL2210R-D-TP	
C771	1-124-477-11	ELECT	47uF 20% 25V	D160	8-719-304-80	DIODE SEL2210R-D-TP	
C772	1-162-282-31	CERAMIC	100PF 10% 50V	D161	8-719-304-80	DIODE SEL2210R-D-TP	
C773	1-162-282-31	CERAMIC	100PF 10% 50V	D162	8-719-304-80	DIODE SEL2210R-D-TP	
C901	1 1-161-744-00	CERAMIC	0.01uF 400V	D601	1 8-719-200-80	DIODE D300	
		< CONNECTOR >		D602	8-719-312-09	DIODE RBA-402	
CN101	* 1-568-848-11	SOCKET, CONNECTOR 5P		D603	8-719-200-77	DIODE 10E2N	
CN102	* 1-562-573-11	SOCKET, CONNECTOR 8P		D604	8-719-001-51	DIODE UZL-11H1	
CN103	* 1-564-599-11	PIN, CONNECTOR 8P		D605	8-719-912-20	DIODE 1SS120	
CN701	1-566-211-11	PIN, CONNECTOR 4P (POWER AMP CONTROL)		D606	8-719-912-20	DIODE 1SS120 (N611)	
CN702	* 1-560-530-00	PIN, CONNECTOR 2P		D607	8-719-912-20	DIODE 1SS120	
CN704	* 1-568-824-11	SOCKET, CONNECTOR 5P		D608	8-719-912-20	DIODE 1SS120 (N611)	
CN705	* 1-564-507-11	PLUG, CONNECTOR 4P		D609	8-719-200-77	DIODE 10E2N	
				D610	1 8-719-200-80	DIODE D300	
				D701	8-719-912-20	DIODE 1SS120	
				D702	8-719-933-36	DIODE HZS6B1L	
				D703	8-719-815-85	DIODE 1S1585	
				D704	8-719-815-85	DIODE 1S1585	

Note:
The components identified by mark ~~1~~ or dotted line with mark ~~1~~ are critical for safety. Replace only with part number specified.

Note:
Les composants identifiés par une marque ~~1~~ sont critiques pour la sécurité. Ne les remplacer que par une pièce portant le numéro spécifié.

MAIN

SP SW

FRONT SP

METER SW

P.S

CN

DRLC SP

P.S2

Ref. No.	Part No.	Description	Remark
D705	8-719-912-20	DIODE 1SS120 (AUS, Canadian, E)	
D705B	8-719-912-20	DIODE 1SS120 (US)	
D706	8-719-912-20	DIODE 1SS120 (N511:Canadian, E, AUS)	
D707	8-719-912-20	DIODE 1SS120 (N611)	
D751	8-719-912-20	DIODE 1SS120	
D752	8-719-933-36	DIODE HZS6B1L	
D753	8-719-815-85	DIODE 1S1585	
D754	8-719-815-85	DIODE 1S1585	
D755	8-719-815-85	DIODE 1S1585	
D756	8-719-912-20	DIODE 1SS120 (AUS, Canadian, E)	
D756B	8-719-912-20	DIODE 1SS120 (US)	
D757	8-719-912-20	DIODE 1SS120 (N511:Canadian, E, AUS)	
< FUSE >			
F901	△ 1-532-350-00	FUSE (T 4A) (N511:E, AUS)	
F901	△ 1-532-749-11	FUSE, GLASS TUBE (8A) (N511:US, Canadian/N611)	
F902	△ 1-532-350-00	FUSE T (4A) (N511:E)	
F903	△ 1-532-237-00	FUSE, TIME LAG (T 3. 15A) (N511:E, AUS)	
F903	△ 1-576-107-11	FUSE (3. 15A) (N511:US, Canadian/N611)	
F904	△ 1-532-237-00	FUSE, TIME LAG (T 3. 15A) (N511:E, AUS)	
F904	△ 1-576-107-11	FUSE (3. 15A) (N511:US, Canadian/N611)	
< IC >			
IC101	8-759-917-42	IC IR2E31A	
IC102	8-759-917-42	IC IR2E31A	
IC151	8-759-917-42	IC IR2E31A	
IC152	8-759-917-42	IC IR2E31A	
IC601	8-759-502-32	IC SI-18752N	
IC602	8-759-502-32	IC SI-18752N (N611)	
IC751	8-759-111-68	IC uPC1237HA	
< JACK >			
J701	1-565-258-11	JACK, PIN 4P (N611)	
J701	1-565-352-11	JACK, PIN 2P (INPUT FRONT) (N511)	
J702	1-565-406-21	JACK, PIN 1P (INPUT REAR) (N511)	
J703	1-563-347-11	JACK, LARGE TYPE (HEADPHONES)	
< COIL >			
L601	* 1-420-872-00	COIL, AIR CORE	
L602	* 1-420-872-00	COIL, AIR CORE (N611)	
L701	* 1-420-872-00	COIL, AIR CORE	
L751	* 1-420-872-00	COIL, AIR CORE	
< TRANSISTOR >			
Q601	8-729-209-15	TRANSISTOR 2SD2012	
Q602	8-729-140-84	TRANSISTOR 2SC1841-PAFAEA	
Q603	8-729-140-84	TRANSISTOR 2SC1841-PAFAEA (N611)	

Ref. No.	Part No.	Description	Remark
Q701	8-729-140-82	TRANSISTOR 2SA988-PAFAEA	
Q702	8-729-620-18	TRANSISTOR 2SA979-FG	
Q703	8-729-620-05	TRANSISTOR 2SC2603-EF	
Q704	8-729-620-05	TRANSISTOR 2SC2603-EF	
Q705	8-729-209-15	TRANSISTOR 2SD2012	
Q706	8-729-141-06	TRANSISTOR 2SA1142-QPE	
Q707	8-729-141-05	TRANSISTOR 2SC2682-QPE	
Q708	8-729-620-05	TRANSISTOR 2SC2603-EF	
Q709	8-729-119-76	TRANSISTOR 2SA1175-HFE	
Q710	8-729-141-46	TRANSISTOR 2SC4431-LK	
Q711	8-729-141-37	TRANSISTOR 2SA1684-LK	
Q712	8-729-320-97	TRANSISTOR 2SC2921M-OPY (N511:US, Canadian)	
Q712	8-729-321-21	TRANSISTOR 2SC4387-OY (N511:E, AUS/N611)	
Q713	8-729-320-73	TRANSISTOR 2SA1215-OY (N511:US, Canadian)	
Q713	8-729-321-24	TRANSISTOR 2SA1672-OY (N511:E, AUS/N611)	
Q714	8-729-321-21	TRANSISTOR 2SC4387-OY (N511:E, AUS/N611)	
Q715	8-729-321-24	TRANSISTOR 2SA1672-OY (N511:E, AUS/N611)	
Q716	8-729-140-84	TRANSISTOR 2SC1841-PAFAEA	
Q717	8-729-620-05	TRANSISTOR 2SC2603-EF	
Q718	8-729-119-76	TRANSISTOR 2SA1175-HFE (N611)	
Q719	8-729-620-05	TRANSISTOR 2SC2603-EF	
Q751	8-729-140-82	TRANSISTOR 2SA988-PAFAEA	
Q752	8-729-620-18	TRANSISTOR 2SA979-FG	
Q753	8-729-620-05	TRANSISTOR 2SC2603-EF	
Q754	8-729-620-05	TRANSISTOR 2SC2603-EF	
Q755	8-729-209-15	TRANSISTOR 2SD2012	
Q756	8-729-141-06	TRANSISTOR 2SA1142-QPE	
Q757	8-729-141-05	TRANSISTOR 2SC2682-QPE	
Q758	8-729-620-05	TRANSISTOR 2SC2603-EF	
Q759	8-729-119-76	TRANSISTOR 2SA1175-HFE	
Q760	8-729-141-46	TRANSISTOR 2SC4431-LK	
Q761	8-729-141-37	TRANSISTOR 2SA1684-LK	
Q762	8-729-320-97	TRANSISTOR 2SC2921M-OPY (N511:US, Canadian)	
Q762	8-729-321-21	TRANSISTOR 2SC4387-OY (N511:E, AUS/N611)	
Q763	8-729-320-73	TRANSISTOR 2SA1215-OY (N511:US, Canadian)	
Q763	8-729-321-24	TRANSISTOR 2SA1672-OY (N511:E, AUS/N611)	
Q764	8-729-321-21	TRANSISTOR 2SC4387-OY (N511:E, AUS/N611)	
Q765	8-729-321-24	TRANSISTOR 2SA1672-OY (N511:E, AUS/N611)	
Q766	8-729-140-84	TRANSISTOR 2SC1841-PAFAEA	
Q767	8-729-900-63	TRANSISTOR DTA124ES	
Q768	8-729-119-76	TRANSISTOR 2SA1175-HFE	
Q769	8-729-119-76	TRANSISTOR 2SA1175-HFE	

Note:

The components identified by mark △ or dotted line with mark △ are critical for safety. Replace only with part number specified.

Note:

Les composants identifiés par une marque △ sont critiques pour la sécurité. Ne les remplacer que par une pièce portant le numéro spécifié.

MAIN

SP SW

FRONT SP

METER SW

P.S

CN

DRLC SP

P.S2

Ref.No.	Part No.	Description	Remark			Ref.No.	Part No.	Description	Remark		
< RESISTOR >											
R101	1-249-441-11	CARBON	100K	5%	1/4W	R707	1-249-438-11	CARBON	56K	5%	1/4W
R102	1-249-405-11	CARBON	100	5%	1/4W	R708	1-249-429-11	CARBON	10K	5%	1/4W
R103	1-249-405-11	CARBON	100	5%	1/4W	R709	1-249-435-11	CARBON	33K	5%	1/4W
R104	1-249-440-11	CARBON	82K	5%	1/4W	R710	1-249-426-11	CARBON	5.6K	5%	1/4W
R105	1-249-429-11	CARBON	10K	5%	1/4W	R711	1-249-435-11	CARBON	33K	5%	1/4W
R106	1-249-433-11	CARBON	22K	5%	1/4W	R712	1-247-830-11	CARBON	910	5%	1/4W
R107	1-249-417-11	CARBON	1K	5%	1/4W	R713	1-249-417-11	CARBON	1K	5%	1/4W
R108	1-249-427-11	CARBON	6.8K	5%	1/4W	R714	△ 1-247-692-11	CARBON	22	5%	1/4W
R109	1-249-413-11	CARBON	470	5%	1/4W	R715	1-249-423-11	CARBON	3.3K	5%	1/4W
R151	1-249-441-11	CARBON	100K	5%	1/4W	R716	△ 1-247-692-11	CARBON	22	5%	1/4W
R152	1-249-405-11	CARBON	100	5%	1/4W	R717	△ 1-247-700-11	CARBON	100	5%	1/4W
R153	1-249-405-11	CARBON	100	5%	1/4W	R718	△ 1-247-700-11	CARBON	100	5%	1/4W
R154	1-249-440-11	CARBON	82K	5%	1/4W	R719	△ 1-247-713-11	CARBON	1K	5%	1/4W
R155	1-249-429-11	CARBON	10K	5%	1/4W	R720	△ 1-247-713-11	CARBON	1K	5%	1/4W
R156	1-249-433-11	CARBON	22K	5%	1/4W	R721	△ 1-247-719-11	CARBON	3.3K	5%	1/4W
R157	1-249-417-11	CARBON	1K	5%	1/4W	R722	△ 1-247-745-11	CARBON	330	5%	1/2W
R158	1-249-427-11	CARBON	6.8K	5%	1/4W	R723	△ 1-247-717-11	CARBON	2.2K	5%	1/4W
R601	1-249-423-11	CARBON	3.3K	5%	1/4W	R724	△ 1-249-455-11	CARBON	4.7	5%	1/4W
R602	1-249-437-11	CARBON	47K	5%	1/4W	R725	△ 1-249-455-11	CARBON	4.7	5%	1/4W
R603	1-249-437-11	CARBON	47K	5%	1/4W	R726	△ 1-214-789-00	RES. METAL PLATE	0.1	5W	(N511:US, Canadian)
R604	1-249-437-11	CARBON	47K	5%	1/4W (N611)	R726	△ 1-217-151-00	RES. METAL PLATE	0.22	2W	(N511:E, AUS/N611)
R605	1-249-437-11	CARBON	47K	5%	1/4W (N611)	R727	△ 1-214-789-00	RES. METAL PLATE	0.1	5W	(N511:US, Canadian)
R606	1-249-409-11	CARBON	220	5%	1/4W	R727	△ 1-217-151-00	RES. METAL PLATE	0.22	2W	(N511:E, AUS/N611)
R607	1-249-417-11	CARBON	1K	5%	1/4W	R728	△ 1-249-455-11	CARBON	4.7	5%	1/4W
R608	1-249-409-11	CARBON	220	5%	1/4W (N611)	R729	△ 1-249-455-11	CARBON	4.7	5%	1/4W
R609	1-249-417-11	CARBON	1K	5%	1/4W (N611)						(N511:E, AUS/N611)
R610	1-249-437-11	CARBON	47K	5%	1/4W	R730	△ 1-217-151-00	RES. METAL PLATE	0.22	2W	(N511:E, AUS/N611)
R611	1-249-437-11	CARBON	47K	5%	1/4W (N611)	R731	△ 1-217-151-00	RES. METAL PLATE	0.22	2W	(N511:E, AUS/N611)
R612	△ 1-217-151-00	RES. METAL PLATE	0.22	2W	(N611)	R732	△ 1-247-702-11	CARBON	150	5%	1/4W
R613	△ 1-217-151-00	RES. METAL PLATE	0.22	2W	(N611)	R733	1-249-427-11	CARBON	6.8K	5%	1/4W
R614	1-249-437-11	CARBON	47K	5%	1/4W						(N511:E, AUS/N611)
R615	1-249-438-11	CARBON	56K	5%	1/4W (N611)	R733	1-249-429-11	CARBON	10K	5%	1/4W
R616	1-260-072-11	CARBON	4.7	5%	1/2W						(N511:US, Canadian)
R617	1-260-072-11	CARBON	4.7	5%	1/2W (N611)	R734	1-260-076-11	CARBON	10	5%	1/2W
R618	1-260-076-11	CARBON	10	5%	1/2W	R735	1-260-076-11	CARBON	10	5%	1/2W
R619	1-260-076-11	CARBON	10	5%	1/2W (N611)	R736	1-249-437-11	CARBON	47K	5%	1/4W
R620	△ 1-247-704-11	CARBON	220	5%	1/4W	R737	1-249-425-11	CARBON	4.7K	5%	1/4W
R621	△ 1-247-704-11	CARBON	220	5%	1/4W (N611)	R738	1-249-433-11	CARBON	22K	5%	1/4W
R622	1-249-428-11	CARBON	8.2K	5%	1/4W	R739	1-249-425-11	CARBON	4.7K	5%	1/4W (N611)
R623	1-249-428-11	CARBON	8.2K	5%	1/4W (N611)	R740	1-249-437-11	CARBON	47K	5%	1/4W (N611)
R701	1-249-417-11	CARBON	1K	5%	1/4W	R741	1-249-425-11	CARBON	4.7K	5%	1/4W
R702	1-249-435-11	CARBON	33K	5%	1/4W						
R703	1-249-421-11	CARBON	2.2K	5%	1/4W						
R704	1-249-411-11	CARBON	330	5%	1/4W						
R705	△ 1-247-704-11	CARBON	220	5%	1/4W						
R706	△ 1-247-704-11	CARBON	220	5%	1/4W						

Note:

The components identified by mark △ or dotted line with mark △ are critical for safety. Replace only with part number specified.

Note:

Les composants identifiés par une marque △ sont critiques pour la sécurité. Ne les remplacer que par une pièce portant le numéro spécifié.

MAIN **SP SW** **FRONT SP** **METER SW** **P.S** **CN** **DRLC SP** **P.S2**

Ref.No.	Part No.	Description	Remark
R742	1-249-433-11	CARBON	22K 5% 1/4W
R743	1-260-100-11	CARBON	1.2K 5% 1/2W
R744	1-260-100-11	CARBON	1.2K 5% 1/2W
R745	1-260-100-11	CARBON	1.2K 5% 1/2W
R746	1-260-100-11	CARBON	1.2K 5% 1/2W
R751	1-249-417-11	CARBON	1K 5% 1/4W
R752	1-249-435-11	CARBON	33K 5% 1/4W
R753	1-249-421-11	CARBON	2.2K 5% 1/4W
R754	1-249-411-11	CARBON	330 5% 1/4W
R755	△ 1-247-704-11	CARBON	220 5% 1/4W
R756	△ 1-247-704-11	CARBON	220 5% 1/4W
R757	1-249-438-11	CARBON	56K 5% 1/4W
R758	1-249-429-11	CARBON	10K 5% 1/4W
R759	1-249-435-11	CARBON	33K 5% 1/4W
R760	1-249-426-11	CARBON	5.6K 5% 1/4W
R761	1-249-435-11	CARBON	33K 5% 1/4W
R762	1-247-830-11	CARBON	910 5% 1/4W
R763	1-249-417-11	CARBON	1K 5% 1/4W
R764	△ 1-247-692-11	CARBON	22 5% 1/4W
R765	1-249-423-11	CARBON	3.3K 5% 1/4W
R766	△ 1-247-692-11	CARBON	22 5% 1/4W
R767	△ 1-247-700-11	CARBON	100 5% 1/4W
R768	△ 1-247-700-11	CARBON	100 5% 1/4W
R769	△ 1-247-713-11	CARBON	1K 5% 1/4W
R770	△ 1-247-713-11	CARBON	1K 5% 1/4W
R771	△ 1-247-719-11	CARBON	3.3K 5% 1/4W
R772	△ 1-247-745-11	CARBON	330 5% 1/2W
R773	△ 1-247-717-11	CARBON	2.2K 5% 1/4W
R774	△ 1-249-455-11	CARBON	4.7 5% 1/4W
R775	△ 1-249-455-11	CARBON	4.7 5% 1/4W
R776	△ 1-214-789-00	RES. METAL PLATE 0.1	5W (N511:US, Canadian)
R776	△ 1-217-151-00	RES. METAL PLATE 0.22	2W (N511:E, AUS/N611)
R777	△ 1-214-789-00	RES. METAL PLATE 0.1	5W (N511:US, Canadian)
R777	△ 1-217-151-00	RES. METAL PLATE 0.22	2W (N511:E, AUS/N611)
R778	1-249-455-11	CARBON	4.7 5% 1/4W (N511:E, AUS/N611)
R779	△ 1-249-455-11	CARBON	4.7 5% 1/4W (N511:E, AUS/N611)
R780	△ 1-217-151-00	RES. METAL PLATE 0.22	2W (N511:E, AUS/N611)
R781	△ 1-217-151-00	RES. METAL PLATE 0.22	2W (N511:E, AUS/N611)
R782	1-247-702-11	CARBON	150 5% 1/4W

Ref.No.	Part No.	Description	Remark
R783	1-249-427-11	CARBON	6.8K 5% 1/4W (N511:E, AUS/N611)
R783	1-249-429-11	CARBON	10K 5% 1/4W (N511:US, Canadian)
R784	1-260-076-11	CARBON	10 5% 1/2W
R785	1-260-076-11	CARBON	10 5% 1/2W
R786	1-249-438-11	CARBON	56K 5% 1/4W
R787	1-249-427-11	CARBON	6.8K 5% 1/4W
R788	1-249-441-11	CARBON	100K 5% 1/4W
R789	1-249-429-11	CARBON	10K 5% 1/4W
R790	1-249-438-11	CARBON	56K 5% 1/4W
R791	1-249-428-11	CARBON	8.2K 5% 1/4W
R792	1-249-429-11	CARBON	10K 5% 1/4W
R793	1-249-429-11	CARBON	10K 5% 1/4W
R794	1-249-429-11	CARBON	10K 5% 1/4W
R795	1-249-429-11	CARBON	10K 5% 1/4W
R796	1-249-399-11	CARBON	33 5% 1/4W
R797	1-249-399-11	CARBON	33 5% 1/4W
R901	△ 1-217-469-00	FUSIBLE	1 5% 1W F
R902	△ 1-217-469-00	FUSIBLE	1 5% 1W F
< VARIABLE RESISTOR >			
RV701	1-238-596-11	RES. ADJ. CAREBON 470	(DC BIAS)
RV751	1-238-596-11	RES. ADJ. CAREBON 470	(DC BIAS)
< RELAY >			
RY702	1-515-790-11	RELAY	
RY703	1-515-790-11	RELAY (N611)	
RY751	1-515-356-00	RELAY	
< SWITCH >			
S101	1-572-816-11	SWITCH, ROTARY (RANGE)	
S701	1-572-812-11	SWITCH, ROTARY SLIDE (SPEAKERS)	
< TERMINAL >			
TM701	1-536-706-00	TERMINAL BOARD (SP) (FRONT SP)	
TM702	1-537-238-11	TERMINAL BOARD (REAR SP)	
TM703	1-537-238-11	TERMINAL BOARD (DRLC SPEAKER) (N611)	

Note:
The components identified by mark △ or dotted line with mark △ are critical for safety. Replace only with part number specified.

Note:
Les composants identifiés par une marque △ sont critiques pour la sécurité. Ne les remplacer que par une pièce portant le numéro spécifié.

MAIN **SP SW** **FRONT SP** **METER SW** **P.S** **CN** **DRLC SP** **P.S2**

Ref. No. Part No. Description Remark

MISCELLANEOUS

- 13 * 1-640-097-11 P. S BOARD (N511:E, AUS)
- 29 * 1-640-099-11 DRLC SP BOARD (N611)
- CNP901 Δ 1-574-902-11 CORD, POWER (N511:E)
- CNP901 Δ 1-590-083-11 CORD, POWER (N511:AUS)
- CNP901 Δ 1-590-771-11 CORD, POWER (N511:US, Canadian/N611)
- CS901 Δ 1-570-307-11 SWITCH (VOLTAGE, SELECTOR) (N511:E)
- S901 Δ 1-554-538-00 SWITCH, PUSH (AC POWER) (1 KEY)
- T901 Δ 1-450-599-11 TRANSFORMER, POWER (N611)
- T901 Δ 1-450-600-11 TRANSFORMER, POWER (N511:US, Canadian)
- T901 Δ 1-450-601-11 TRANSFORMER, POWER (N511:E, AUS)

ACCESSORY & PACKING MATERIAL

- Δ 1-569-007-11 ADAPTER, CONVERSION 2P (N511:E)
- 3-753-462-11 MANUAL, INSTRUCTION (ENGLISH, FRANCH,
SPANISH, CHINESE) (N511:E, AUS)
- 3-753-462-21 MANUAL, INSTRUCTION (ENGLISH)
(N511:US/N611)
- * 4-923-820-02 CUSHION
- * 4-944-043-01 INDIVIDUAL CARTON (N511:US, E, AUS)
- * 4-944-045-01 INDIVIDUAL CARTON (N611)

<p>Note: The components identified by mark Δ or dotted line with mark Δ are critical for safety. Replace only with part number specified.</p>	<p>Note: Les composants identifiés par une marque Δ sont critiques pour la sécurité. Ne les remplacer que par une pièce portant le numéro spécifié.</p>
--	--

