SOUNDCRAFT CPS250 CPS275

Console Power Supply

User and Technical Manual

For your own safety and to avoid invalidation of the warranty all text marked with these Warning Symbols should be read carefully.



IMPORTANT: please read this manual carefully before connecting your Soundcraft console power supply to the mains for the first time.





© Harman International Industries Ltd. 1997, 2001

All rights reserved

Parts of the design of this product may be protected by worldwide patents.

Part No. ZM0195 Issue 4

Soundcraft is a trading division of Harman International Industries Ltd.

Information in this manual is subject to change without notice and does not represent a commitment on the part of the vendor. Soundcraft shall not be liable for any loss or damage whatsoever arising from the use of information or any error contained in this manual, or through any mis-operation or fault in hardware contained in the product.

No part of this manual may be reproduced, stored in a retrieval system, or transmitted, in any form or by any means, electronic, electrical, mechanical, optical, chemical, including photocopying and recording, for any purpose without the express written permission of Soundcraft.

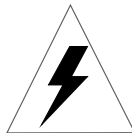

It is recommended that all maintenance and service on the product should be carried out by Soundcraft or its authorised agents. Soundcraft cannot accept any liability whatsoever for any loss or damage caused by service, maintenance or repair by unauthorised personnel.



Harman International Industries Ltd.
Cranborne House
Cranborne Industrial Estate
Cranborne Road
Potters Bar
Herts.
EN6 3JN
England

Tel: 01707 665000
Fax: 01707 660482

Table of Contents

Introduction	1
<i>Introduction</i>	2
<i>Short-circuit Protection</i>	2
<i>Mains Voltage Selection</i>	3
<i>Replacing Mains Fuse</i>	3
<i>Warranty</i>	4
Recommendations For Installation	5
<i>Recommendations For Installation</i>	6
<i>General</i>	7
<i>Dimensions</i>	8
<i>PSU Linking (CPS275 Only)</i>	8
Technical Specification	9
Technical Description	11
<i>Circuit Diagram (1)</i>	12
<i>Circuit Diagram (2)</i>	13
<i>Circuit Description</i>	14
<i>Servicing</i>	17
<i>PCB Layout</i>	20
<i>Output Pinouts</i>	21
Parts List	23

Introduction

Introduction



WARNING: THIS APPARATUS MUST BE EARTHED

The CPS250/CPS275 are linear power supplies which, like other linear supplies, produce DC voltages by rectifying, smoothing and regulating AC voltages from the secondary windings of a mains transformer. Soundcraft mixing consoles employ a number of dc voltage supply levels in their operation and these are all provided at the output of each supply unit.

The CPS275 provides higher currents than the CPS250. The CPS275 also has the capability of being linked to a second CPS275 to provide automatic power backup in the event of one of the units failing.

In regulating these voltages there is considerable heat generated, the dissipation of which is achieved through a substantial internal heat sink. A fan is incorporated which draws air over the heatsinks to provide adequate heat dissipation for the regulators and reduce the outer case temperature.

The CPS250/CPS275 is designed for installation in a 19" rack unit, occupying 2U of rack height. Refer to the section "RECOMMENDATIONS FOR INSTALLATION" on Page 5.

LED indication is provided on the front panel to show operation of the regulating circuits.

SHORT-CIRCUIT PROTECTION

The +/-17V rails can withstand a short to ground or each other for up to one second; if the short circuit remains for longer than one second then both of the 17V rails will be shut down. To reset them the supply must be switched off for 6 seconds and then switched on again.

The +5V and +48V are current limited and will self recover when any short circuit is removed.

MAINS VOLTAGE SELECTION

Special attention should be paid to the following information:



Do not change the voltage setting without first turning the unit off and unplugging the mains lead.

This unit is capable of operating over a range of mains voltages by means of a 4-position mains input fuse carrier. It is important to ensure that the correct voltage setting is selected for the level of local mains voltage supply, for safe, uninterrupted operation of the unit. Voltage selection is achieved by positioning the fuse carrier so that the required voltage appears next to the arrow which is moulded in the connector. In this way the unit is set up for operation at one of the following ranges of mains supply:

NOMINAL VOLTAGE	OPERATING VOLTAGE RANGE (+10/-15%)
<i>V_{rms} AC</i>	<i>V_{rms} AC</i>
230	196 - 253
115	98 - 126
100	85 - 110
85	73 - 93

To remove the fuse use a small screwdriver to prise the fuse carrier from its location in the connector.



To avoid risk of fire use the correct value fuse, as indicated on the unit.

REPLACING MAINS FUSE

Switch the ON/OFF switch to the OFF position. Remove the mains lead from the connector. Use a small screwdriver to prise the fuse carrier from its location in the connector. Check the fuse and replace if necessary; also check that the voltage selection is correct for the mains supply level before switching the unit ON again.

In the event of repeated failure of the mains fuse consult the Soundcraft dealer from where the unit was purchased.



This unit contains no user serviceable parts. Refer all servicing to a qualified service engineer, through the appropriate Soundcraft dealer.

Warranty

1 **Soundcraft** is a trading division of Harman International Industries Ltd.

End User means the person who first puts the equipment into regular operation.

Dealer means the person other than Soundcraft (if any) from whom the End User purchased the Equipment, provided such a person is authorised for this purpose by Soundcraft or its accredited Distributor.

Equipment means the equipment supplied with this manual.

2 If within the period of twelve months from the date of delivery of the Equipment to the End User it shall prove defective by reason only of faulty materials and/or workmanship to such an extent that the effectiveness and/or usability thereof is materially affected the Equipment or the defective component should be returned to the Dealer or to Soundcraft and subject to the following conditions the Dealer or Soundcraft will repair or replace the defective components. Any components replaced will become the property of Soundcraft.

3 Any Equipment or component returned will be at the risk of the End User whilst in transit (both to and from the Dealer or Soundcraft) and postage must be prepaid.

4 This warranty shall only be available if:

a) the Equipment has been properly installed in accordance with instructions contained in Soundcraft's manual; and

b) the End User has notified Soundcraft or the Dealer within 14 days of the defect appearing; and

c) no persons other than authorised representatives of Soundcraft or the Dealer have effected any replacement of parts maintenance adjustments or repairs to the Equipment; and

d) the End User has used the Equipment only for such purposes as Soundcraft recommends, with only such operating supplies as meet Soundcraft's specifications and otherwise in all respects in accordance Soundcraft's recommendations.

5 Defects arising as a result of the following are not covered by this Warranty: faulty or negligent handling, chemical or electro-chemical or electrical influences, accidental damage, Acts of God, neglect, deficiency in electrical power, air-conditioning or humidity control.

6 The benefit of this Warranty may not be assigned by the End User.

7 End Users who are consumers should note their rights under this Warranty are in addition to and do not affect any other rights to which they may be entitled against the seller of the Equipment.

Recommendations For Installation

FOR UK USERS ONLY



**IMPORTANT WARNING
THIS APPLIANCE MUST BE EARTHED**

The wires in the mains lead are coloured in accordance with the following code:

Green and Yellow:	Earth
Blue:	Neutral
Brown:	Live

As the colours of the wires in the mains lead may not correspond with the coloured markings identifying the terminals in your plug, proceed as follows:

- The wire which is coloured Green and Yellow must be connected to the terminal in the plug which is marked with the letter E or by the earth symbol.
- The wire which is coloured Blue must be connected to the terminal in the plug which is marked with the letter N or coloured Black.
- The wire which is coloured Brown must be connected to the terminal in the plug which is marked with the letter L or coloured Red.

Recommendations for Installation

The CPS250/CPS275 power supply is provided with front panel fixing holes for 19" rack-mounting and will occupy 2U of rack space.

As with any power supply that contains a large mains-voltage transformer, it is preferable to provide a degree of physical isolation of the unit from other electronic equipment, particularly that which carries low level audio signals, to avoid any possible hum pick-up. For this reason the unit is used with a long (7 metres) output cable to enable it to be positioned away from the mixing console.

For the same reason, when rack-mounting it is preferable to avoid locating the unit adjacent to signal processing equipment.

It should be noted that if a complete rack containing a CPS250/CPS275 unit is to be operated from a different mains supply level, then the unit should be withdrawn from the rack in order to reselect the mains voltage setting, at the same time as resetting any other equipment.

The other important consideration when rack-mounting the unit is the need for natural convection of air over the case and an unrestricted air flow through the unit. Note that air is drawn in at the rear of the unit and expelled through the front panel.

Good ventilation BELOW the unit, in the floor or back of the rack, and similarly ABOVE the unit, at the top of the rack, will ensure a path for continuous air flow.

Other equipment in the rack which is known NOT to produce a significant amount of heat should be mounted BELOW the unit. Equipment that also relies on good air flow within the rack (ie. most power amplifiers and other power supplies) should be given due consideration and some space should be provided between such units and between these and the CPS250/CPS275 unit. Forced convection, by means of a fan-tray, may be desirable in this situation.



The CPS250/CPS275 will operate as a free-standing unit without requiring any special cooling arrangement, but should not be allowed to be accidentally or deliberately covered over in any way.



Do not operate the unit with the top cover removed.



The air intake and outflow holes must be inspected regularly and cleaned if necessary to maintain good airflow through the unit. This will be particularly important if the unit is used in a dusty environment.

Finally, some consideration should be given to the earthing arrangement of the system at the centre of which are the console and the CPS250/CPS275 (and any other Soundcraft power supply units). The console chassis is earthed, through the mains earth, via the power supply. When rack-mounting the CPS250/CPS275 (and any other Soundcraft power supply units) care should be taken to avoid any possible 'ground loops' in the system which would introduce audible hum to otherwise clean audio signals. Ground loops may occur where signal processing equipment, patched to the console, has its signal earth commoned to the equipment chassis. The ground loop is

formed if this chassis and the power supply chassis are in electrical contact through the fixing rails they share in the rack. To avoid this situation, standard isolating washers may be employed when fixing the power supply (or supplies) or any other unit into the rack.



W A R N I N G : THIS APPARATUS MUST BE EARTHED. Under no circumstances should the mains earth be disconnected from the CPS250/CPS275 power supply unit.

GENERAL

As with all electrical/electronic equipment care should be taken when handling this unit. Avoid general mishandling and do not drop. Avoid storage and operation in dusty locations and do not expose to corrosive atmospheres.



To avoid risk of fire do not expose this unit to rain or moisture.

Retain all packaging for transportation in the event of the unit requiring servicing. Retain this manual safely, along with all other relevant documents.

For touring/mobile transportation it is advisable to install the CPS250/CPS275 in a flight case to provide mechanical protection. Refer to your Soundcraft dealer for a suitable case.

Where the CPS250/CPS275 is enclosed in a touring case, provision must be made for adequate ventilation to the rear of the unit to ensure unrestricted supply of air for the cooling fan.



Use only the high-current mains lead supplied, not the more common 5A type supplied with other equipment.

PSU Linking (CPS275 Only)

The output voltages from the CPS275 are fed via diodes as shown in the adjacent diagram. This allows a standby CPS275 to automatically takeover in the event of a power rail failing.

When a spare CPS275 is ordered it comes with a 1metre linking cable. This should be connected between the link connectors as shown in the diagram.

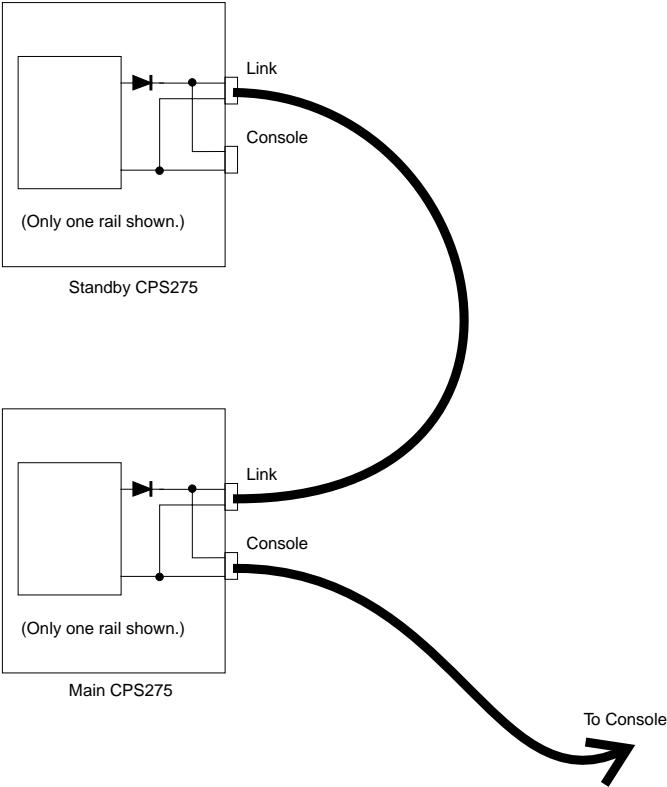

Dimensions

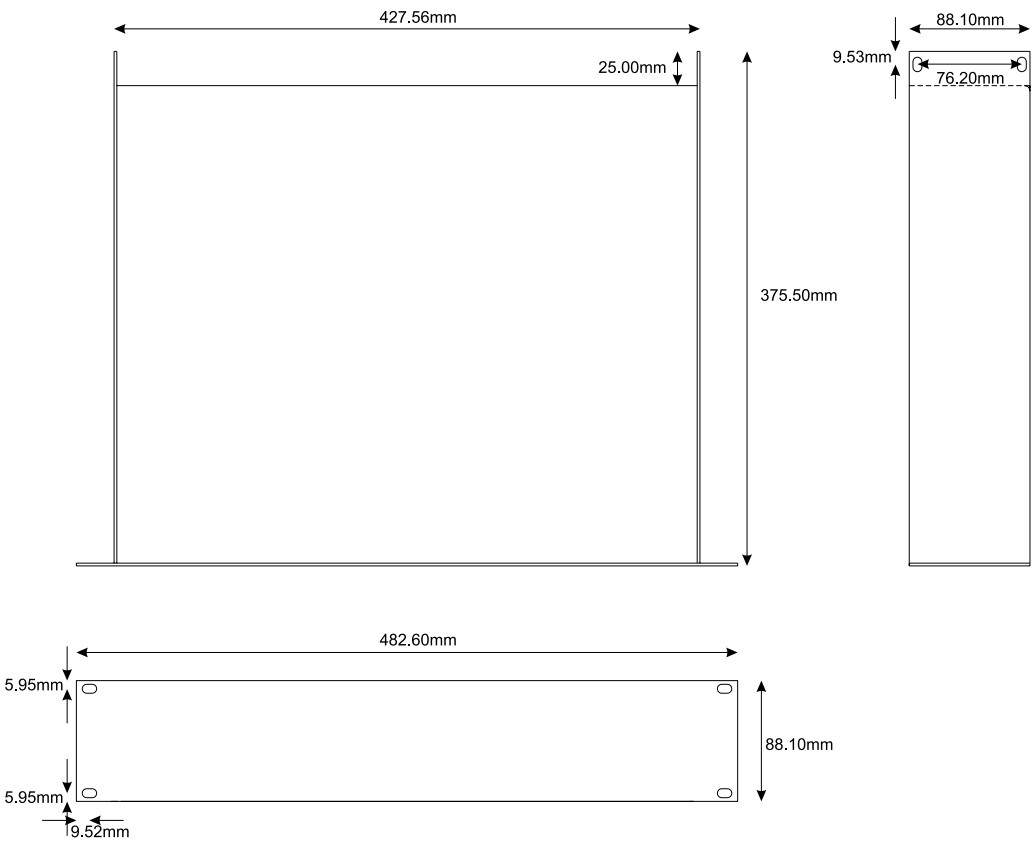

Technical Specification

Technical Specification

MAINS INPUT VOLTAGE RANGE:

85/100/115/230 V AC +10%/-15% @ 50/60Hz

RATED INPUT POWER (Max):

CPS250 - 350 WATTS

CPS275 - 450 WATTS

MAINS FUSE RATING:

Use T3.15A/250V (slow-blow) for 230V

Use T6.3A/250V (slow-blow) for 85/100/115V

OUTPUTS

DC. VOLTAGE RAIL	MAX. OUTPUT CURRENT	
	CPS250	CPS275
+17.5V	4.00 AMPS	5.25 AMPS
-17.5V	4.00 AMPS	5.25 AMPS
+5V	1.00 AMPS	1.00 AMPS
+48V	0.30 AMPS	0.30 AMPS



All voltage and current measurements are to be taken at the console-end of the power supply cable.

OPERATING TEMPERATURE RANGE (Ambient):

-10 TO +40°C.

HUMIDITY:

Similar unit tested at 0-90% RH non-condensing +/-5% Relative Humidity at 40 °C for 16 hours. Load switched between 20% and 100% at regular 30 minute intervals.

OVERALL DIMENSIONS:

HEIGHT: (exc. feet)		88.10mm. (2U)
WIDTH:	Chassis	427.56mm.
	Front panel	482.60mm.
DEPTH: (excl. connectors)		350.50mm.

WEIGHT:

(Excl. packing): 11Kg

Technical Description

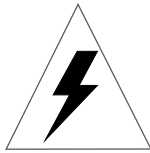

**Servicing should only be carried out by a competent service engineer.
SEE THE WARNINGS STARTING ON PAGE 17.**

Circuit Diagram (2)

INITIAL	ISSUE	DATE
DRG5	7.01	28-10-97

DRG NO. ED 3803B

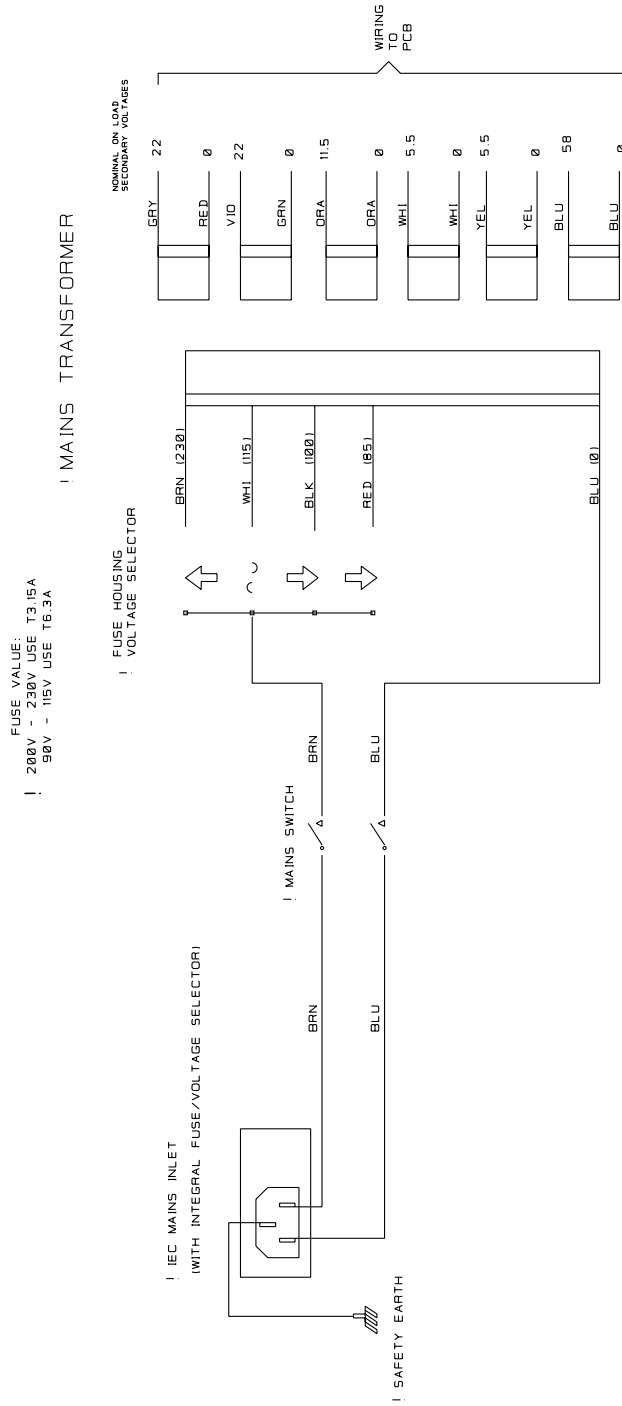

DRN	MDC	TITLE	CPS250/275
		POWER SUPPLY MAINS INPUT CCT	
DRG NO.	ED	3803B	SHT. 2 OF 2
NOTES	NOTES		

Circuit Description

The CPS250 and CPS275 power supplies provide +/-17V at 4 Amps and 5.25 Amps respectively. Both give +5V at 1 Amp, and +48V at 0.3 Amp. The PCB is SC3803.

THE +/- 17V RAILS.

This consists of two identical +17V supplies connected together to give +/-17V. Each 17V supply is a linear regulator with conventional fullwave rectification and 20,000uF reservoir capacitors. This is combined with a second power supply that sits on top to power the driver transistors and the control IC; this reduces the minimum voltage drop across the series-pass device and so improves efficiency.

The main series-pass element is a 250W discrete bipolar transistor mounted on a fan-cooled heatsink. The voltage reference and servo control amplifier are provided by a 723 regulator IC.

The circuitry of the +17V regulator is described in detail below:

The +17V Supply.

The transformer secondary is fused by F1. Secondary fuses will normally only blow in the event of serious failure, such as a major short in the AC wiring or a failed bridge rectifier.

The fullwave bridge rectifier is mounted on the heatsink, at the hottest end as it is the most heat-tolerant of the semiconductors. For safety reasons, the reservoir capacitor is discharged by bleeder resistors R39,40 at switchoff; this takes about 10 seconds. The unregulated DC voltage is approx +26 to +29V.

The 723 IC contains a 7.15V nominal Zener diode, defining the voltage that appears at Pin 6. R5 is in series with the positive input of the servo opamp (Pin 5) and is made roughly equal in resistance to the feedback divider R7,11 etc to minimise bias-current offsets.

The feedback divider R7,8,11, & PR1 derives a fraction of the output voltage and delivers it to the negative input of the servo opamp. (Pin 4) The negative feedback keeps this point also at 17.15V, so the actual output voltage is determined by the feedback divider ratio, which is trimmed over a narrow range by PR1.

The output of the servo opamp controls the output through TR1, an emitter follower driving the series-pass device TR3. The power supply to TR1 is taken from the +12V supply developed across C23. This has its 0V side connected to the positive unregulated DC supply of 26 - 29V, (at nominal mains) giving a total voltage of approx 38 - 41V for the driver; this also powers the 723 IC via R1. This subrail markedly reduces the minimum drop across the pass elements and therefore increases the efficiency.

10 Amp Schottky diode D25 on the output allows supplies to be paralleled for redundancy. This is only fitted for the CPS275 option.

Overcurrent Protection.

The power supply is protected against short-circuits and overload by a dual-mode protection system; brief overloads are dealt with by constant-current protection, while prolonged overload causes both 17V rails to shutdown. Reset is by turning the mains power off for not less than 6 seconds.

The constant-current protection system works in the standard way; when an attempt is made to draw excessive current, the output voltage is reduced so that no more than a fixed maximum can be drawn. However, the high current capability of this PSU means that long-term constant-current protection alone is not practical as the dissipation in the pass devices is too high for the cooling system to deal with, and in time they will overheat.

The constant-current system measures the output current by sensing the voltage drop across resistors R18,19 in parallel. When it reaches approx 0.60 V the internal protection transistor in IC1 is turned via R41, and the output voltage on pin 10 pulled down to limit the current supplied.

If this condition persists for longer than one second, then both rails of the +/-17V supply are shut down by the Mutual Shutdown System, described below.

The Mutual Shutdown System.

Equipment containing some kinds of op-amp is vulnerable to damage when only one of the +/-17V rails fails, as in this case excessive supply currents can be drawn, damaging fuse resistors on the modules.

When both 17V supplies are working normally, DZ1,DZ2 are conducting, LED1 is on and opto-couplers OP1,2 have their photo-transistors conducting. Therefore TR5 does not conduct, and the supply works normally.

If the -17V rail collapses, there is no longer enough voltage to keep DZ1,DZ2 on, and OP1 switches off. TR5 is turned on by R16, with R28,30 and C40 providing a time-delay to prevent spurious operation on transients, or brief overloads which are dealt with by the constant-current protection system. TR5 now pulls down an internal node of IC1 via pin 13, and the +17V supply is shut down.

In the same way, if the +17V supply fails, OP2 switches off, TR6 is turned on by R17, and the -17V supply is shut down.

The -17V Supply.

This is identical in operation to the +17V section described above.

The +48V Supply.

Max current rating is 0.3 Amps. The +48V phantom supply is based on the special high-voltage regulator TL783C. (REG1) The AC input is fused by F3 and fullwave rectified by D15-18; C31 is the reservoir capacitor. C32 ensures HF stability of REG1. The TL783C maintains a fixed 1.27 V between its ADJ and OUT pins, so the adjustable voltage-divider R22-PR3-R23 gives an output of approx 48V. This can be finely adjusted by PR3. C33 minimises output ripple. Rail indicator LED2 is powered through DZ3,4, which total 30V, so even a partial fall in rail voltage will extinguish it.

Two protection diodes are included. D13 protects the regulator from reverse voltage if there is a charged capacitor across the output but the voltage on C31 has collapsed. D20 prevents the ADJ pin from rising above the OUT pin (due to the charge on C33) if the output is shorted.

Diode D22 on the output (CPS275 only) allows supplies to be paralleled for redundancy.

The +5V Supply.

Max current rating 1.0 Amps. This supply is primarily intended for powering console internal computers; it also powers the cooling fan.

The AC input is fused by F4 and fullwave rectified by D9-12, with C36 as the reservoir capacitor. The LM340 regulator has a fixed 5.0V output. C35 ensures regulator stability.

A protection diode is included; D14 protects the regulator from reverse voltage if there is a charged capacitor across the output but the voltage on C36 has collapsed.

Diode D23 on the output (CPS275 only) allows supplies to be paralleled for redundancy.

Servicing



SAFETY.

These safety notes are directed to those testing and repairing this power supply. **Legal requirements mean that we must not encourage untrained personnel to take the lid off.**



Servicing should only be carried out by a competent service engineer.

This supply contains mains voltages on the voltage select PCB, the mains switch, etc, and the usual precautions must be taken.

The main reservoir capacitors have a capacity of 20,000 uF, and are charged to +26V.

THIS CAN BE DANGEROUS.

The danger lies not in the voltage, but in the large currents that will flow if the capacitor terminals are shorted. A small screwdriver will simply disappear in a violent explosion. The main bodily danger is from metal watchstraps, etc. Serious burns are very likely if these contact the capacitor.

For safety reasons, the reservoir capacitors are discharged by bleeder resistors at switchoff; this takes about 10 seconds.

The unregulated supply to the +48V regulator can reach +90V on high mains, and should be treated with some respect.

Initial operational tests on the power supply can be carried out by switching the unit ON and checking the voltages present on the output connectors on the back of the unit. While the unit remains disconnected from the mixing console some of the DC voltage rails are floating with respect to each other, that is they do not all have a common reference within the unit. When connection is made to the mixing console various output pins become earthed to a common star-point, which has a mains earth return in the power supply cable itself.

An indication of obvious fault condition is the failure of one or more of the front-panel LED's to light.

Any fault condition, with the exception of simple mains fuse failure due to underrating or an unusual mains input condition, will require removal of the top cover to enable fault correction. This is achieved using a cross-head screwdriver to remove the six retaining screws and washers. Carefully lift the cover to avoid the earth connecting lead to the cover from snagging. Place the cover face down behind the unit.

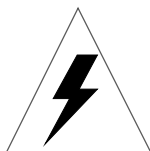

WARNING: At the front of the unit just behind the front panel is the MAINS SWITCH, which carries HIGH VOLTAGES directly from the mains input. Similarly on the rear panel is the MAINS INPUT SOCKET/MAINS VOLTAGE SELECTOR. Care MUST be taken when carrying out any servicing operation with the top cover removed.

FAULTFINDING NOTES.

+/- 17V RAILS.

If one side of the +/-17V supply is not working, the mutual shutdown system will close down both sides of the supply. This makes faultfinding difficult as it is often not obvious which side has failed. The mutual shutdown can be disabled by linking pins 4 and 5 on BOTH opto-isolators

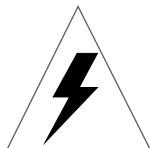

IT IS ESSENTIAL THAT THIS IS REMOVED AFTER SERVICING IS COMPLETED! FAILURE TO DO THIS MAY CAUSE SEVERE CONSOLE DAMAGE IF ONLY ONE 17V RAIL SHUTS DOWN.

If there is no power to the 723 IC (eg if R1 or R2 is open- circuit) the output will remain low, but no damage occurs.

+8V SUPPLY.

This is a completely standard IC regulator circuit. The regulator REG3 is the only part that is likely to fail.

REPLACING COMPONENTS



Replacement of any components should be undertaken only after switching the power supply unit OFF and disconnecting the mains supply lead from the power supply unit.

Replacement of any of the fuses in the power supply units is possible without the removal of the circuit board.

The fuses are held in open fuseholders on the top of the board. These can be carefully removed by hand. Ensure that the insulating fuse covers are replaced with the new fuses.

Various components are mounted along the heatsink extrusion. The extrusion/pcb assembly must be removed from the case to gain access to the underside of the pcb in order to unsolder and/or undo the appropriate component. They can be removed by desoldering the pins, where appropriate, and unscrewing the fixing nuts or the fixing screws, taking care to retain the small insulating bush(es).



Retain carefully the mounting pads and plastic insulating bushes where fitted. **THESE MUST BE CORRECTLY REFITTED TO AVOID DAMAGE TO THE UNIT.**

The correct high efficiency mounting pad must be used, and this should be replaced if it appears to be damaged (see the Parts Lists for the relevant Soundcraft Part Numbers). When refixing or replacing the device, it is important to screw the device down before resoldering the pins to avoid stressing the pads on the circuit board.

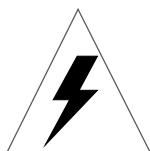

NOTE : The heatsink bracket is earthed through its mechanical contact with the rest of the chassis and so a faulty mounting pad may cause the output of its regulator to be connected to earth.



Take care not to bend the pins on the regulators, or to strain the corresponding pads on the circuit board

Reassembly is simply a reverse of the procedure above. Particular care should be taken when fixing the regulators, ensuring that the pins are not bent or the circuit board pads strained when the fixing screws are tightened. The regulator screws are tapped into a relatively soft aluminium heatsink. **DO NOT OVER-TIGHTEN** or you will strip the thread in the heatsink. High performance mounting pads must be fitted between the regulators and the heatsink. The regulators must be checked for isolation from the heatsink using a multimeter.

Re-dress cable forms in their original positions and secure where applicable with cable ties.

OUTPUT VOLTAGE ADJUSTMENTS

The +/-17V and +48V rails are adjustable via trimpots on the pcb. After any repair these should be checked **on load** and adjusted if necessary. Set the 17V rails to 17.5V +/- 0.1V, and the 48V rail to 48.3 +/- 0.1V. The 5V rail is not adjustable.

GENERAL

Before replacing the top cover on the unit, carefully remove any dust from surfaces within the unit.



Carefully check all wiring connections and ensure that there are no loose parts lying around inside the unit.

PCB Layout

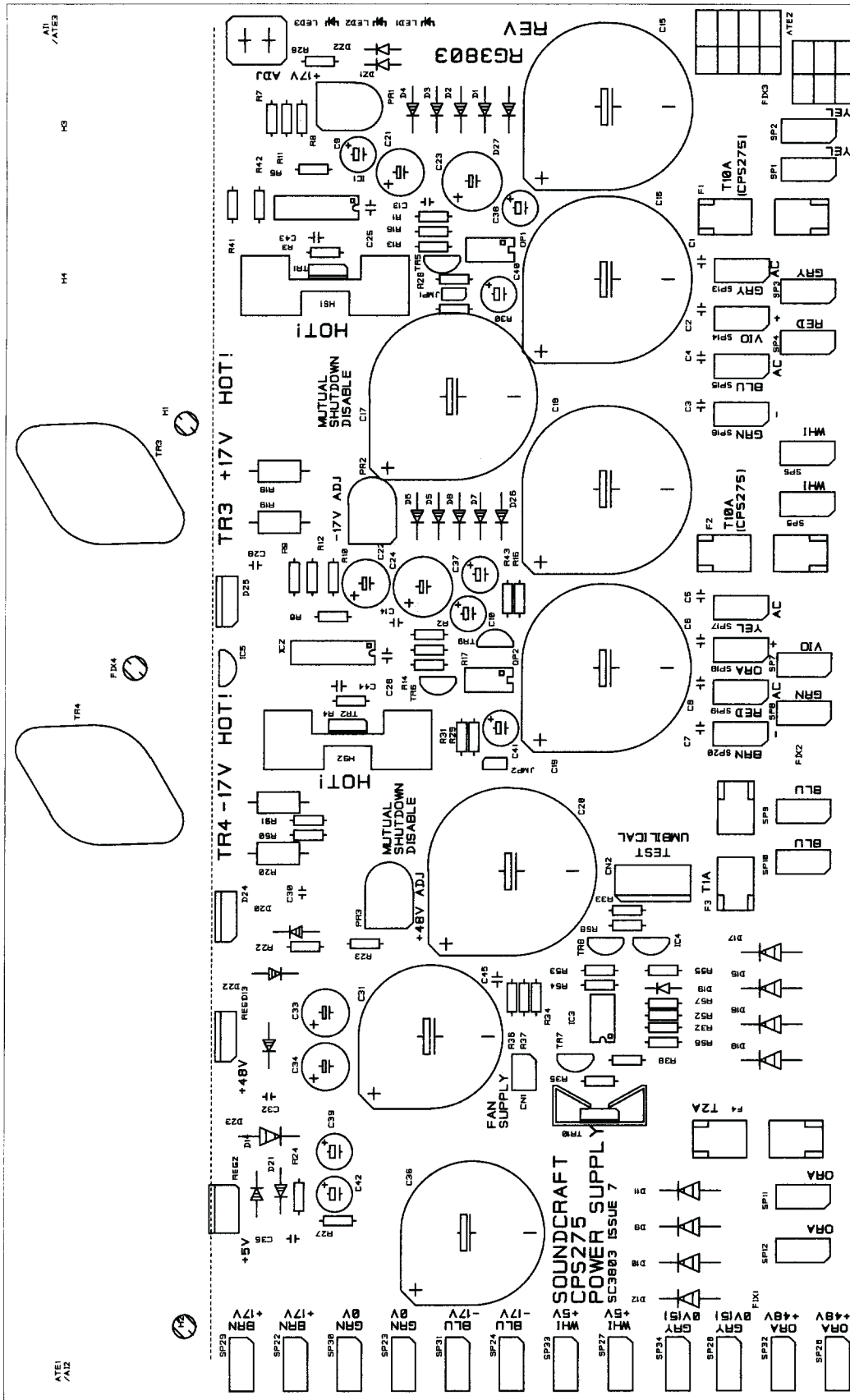

Output Pinouts

Wire List		
SRC	Voltage	Wire Colour
PIN 1	+17 V DC	BROWN
PIN 2	+5 V DC	WHITE
PIN 3	-17 V DC	BLUE
PIN 4	Chassis Earth	GRN/YEL
PIN 5	0V (+/-17V & 48V)	GREEN
PIN 7	0V (5V)	GREY
PIN 10	+48 V DC	ORANGE

REAR VIEW OF SRC
(VIEWED FROM INSIDE PSU)

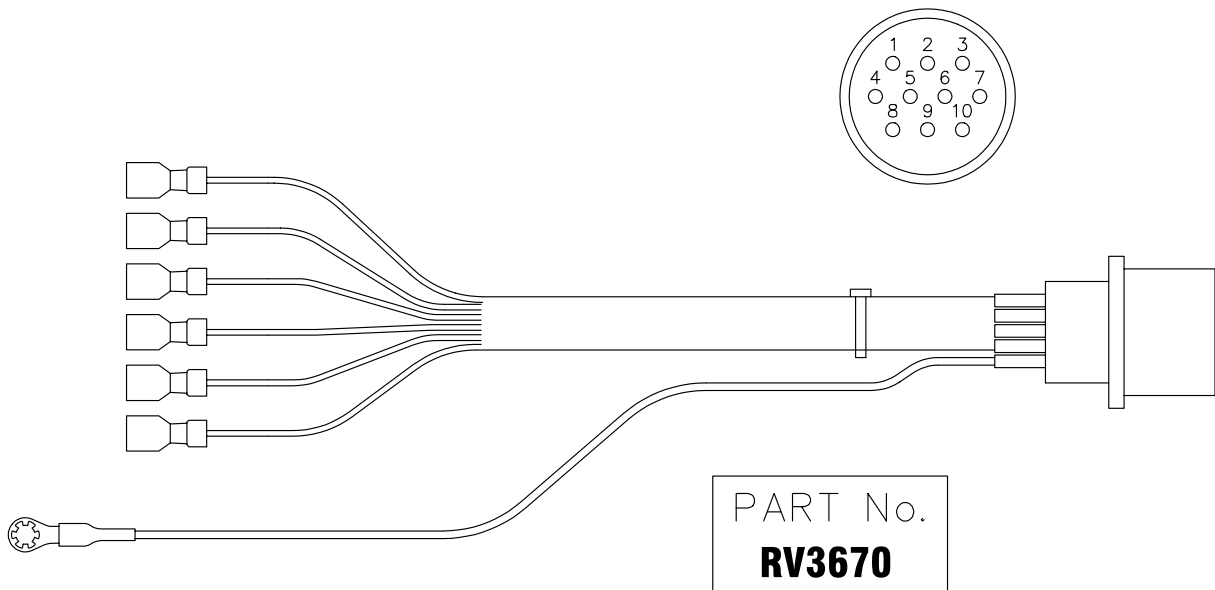

Parts List

Spare Parts

Notes:

- 1) The 'Module/PCB Assemblies' section is indented to show those items which are part of another, higher level, item.
- 2) Some of the descriptions are followed by one of the following 3 symbols:
 - # - STATIC SENSITIVE. Anti-static precautions must be taken whilst handling this part.
 - ! - SAFETY CRITICAL PART. A part of a different type may not be substituted.
 - @ - A part from a specific Manufacturer. Using an equivalent from another manufacturer may lead to loss of performance.

Top-Level Structures

CPS250 POWER SUPPLY UNIT

RW8019

---	!NON ILL.RK SWT DPST(2600M11E) !	DL8000
---	!IEC MAINS SKT 10A CPS250/275 !	FJ8029
---	CABLE TIE 4.3"	LF0501
---	CABLE TIE BASE 19X19MM	LF0567
---	M4X8MM PAN POZI SCRW BLCK	NA0241
---	NO6 X 5/8" TYPE B PAN POZI BLK	NA0258
---	M3X6 PN PZI W/CAPT WASHER ZNC	NA0401
---	M5 X 60MM HEX BOLT SET BLACK	NA0420
---	NO8X3/8" CSK POZ BLK TYPE B	NA0427
---	M4 NYLON INSERT NUT TYPE T	NB0127
---	M5 S/PROOF WASHER	NC0217
---	M4 PLAIN STEEL WASHER ZNC CLR	NC0249
---	M4 BLACK PLASTIC WASHER	NC0250
---	M3X12.7MM THRD HEX SPACER	ND0382
---	RIVET 1/8"X0.310" DOME HEAD	NF0505
---	NYLON PLUG 25.5 DIA(LOCKING)	NZ2360
---	CPS250 POWER SUPPLY CHASSIS	PH1400-01
---	CPS250/275 POWER SUPPLY LID	PJ1500-01
---	CPS250 ELEC MECH ASSY	RS5961
---	DCP200 LID EARTH WFM	RV3491
---	CPS250 TRANSFORMER WFM	RV3666
---	CPS250/275 RECTIFIER WFM	RV3668
---	CPS250/275 MAINS SWT WFM	RV3669
---	CPS275/250 DC OUTPUT WFM	RV3670
---	CPS250/275 CARTON	TA0416
---	CPS250/275 CABLE TRAY	TA0417
---	CPS250/275 FOAM ENDCAPS SET	TB0276
---	PSU EARTH SYMBOL SLF-ADH	ZA0078
---	!5X20MM T6.3A/250V AS FUSE !	ZD8106
---	RICHO SCREW ON PLASTIC FEET	ZZ2541

CPS275 POWER SUPPLY UNIT

RW8020

---	!NON ILL.RK SWT DPST(2600M11E) !	DL8000
---	!IEC MAINS SKT 10A CPS250/275 !	FJ8029
---	CABLE TIE 4.3"	LF0501
---	CABLE TIE BASE 19X19MM	LF0567
---	M4X8MM PAN POZI SCRW BLCK	NA0241
---	NO6 X 5/8" TYPE B PAN POZI BLK	NA0258
---	M3X6 PN PZI W/CAPT WASHER ZNC	NA0401
---	M5 X 60MM HEX BOLT SET BLACK	NA0420
---	NO8X3/8" CSK POZ BLK TYPE B	NA0427
---	M4 NYLON INSERT NUT TYPE T	NB0127
---	M5 S/PROOF WASHER	NC0217
---	M4 PLAIN STEEL WASHER ZNC CLR	NC0249
---	M4 BLACK PLASTIC WASHER	NC0250
---	M3X12.7MM THRD HEX SPACER	ND0382
---	RIVET 1/8"X0.310" DOME HEAD	NF0505
---	CPS275 POWER SUPPLY CHASSIS	PH1401-01
---	CPS250/275 POWER SUPPLY LID	PJ1500-01
---	CPS275 ELEC MECH ASSY	RS5962

---	DCP200 LID EARTH WFM	RV3491
---	CPS275 TRANSFORMER WFM	RV3667
---	CPS250/275 RECTIFIER WFM	RV3668
---	CPS250/275 MAINS SWT WFM	RV3669
---	CPS275/250 DC OUTPUT WFM	RV3670
---	CPS250/275 CARTON	TA0416
---	CPS250/275 CABLE TRAY	TA0417
---	CPS250/275 FOAM ENDCAPS SET	TB0276
---	PSU EARTH SYMBOL SLF-ADH	ZA0078
---	!5X20MM T6.3A/250V AS FUSE !	ZD8106
---	RICHO SCREW ON PLASTIC FEET	ZZ2541

Main Assemblies

---	CPS250 ELEC MECH ASSY	RS5961
---	BDG RECT BR152 200V 15A	BC0210
---	MJ15024 NPN POWER TRANS TO3 @	BD0373
REG1,	VOLTAGE REG TL783CKC	BE0455
REG2,	REG LM340AT 5.0V	BE0491
---	M5X30MM PAN POZI SCREW	NA0094
REG1,2,	M3 X 8MM PAN POZI BLCK SCRW	NA0130
---	NO6X5/8 PAN CROSS REC B ZINC	NA0373
---	M5 NYLON INSERT NUT	NB0116
---	NYLOCK NUT ZINC 6-32 UNIFIED	NB0173
---	NO6 PLASTIC WASHER 1.58MM	NC0295
---	FAN GASKET 80.00MM	NZ2357-02
---	CPS250/275 PSU HEATSINK	PN1261-01
---	CPS250 PSU PCB ASSY	RC3803A
---	UNIVERSAL FAN WFM	RV3142
REG1,2,	TIP INS BUSH	ZC0215
REG1,2,	KOOL PAD LM317T/337T	ZC0217
---	30CMX30CM THERMALLY CNDCTV SHT	ZC0223
---	KERATHERM 86/10 PAD	ZC0230
---	!FUSE COVER SCHURTER 853-9561 !	ZD8013
F3	!5X20MM T1A/250V AS FUSE !	ZD8101
F4	!5X20MM T2A/250V AS FUSE !	ZD8102
F1, F2	!5X20MM T6.3A/250V AS FUSE !	ZD8106

---	CPS275 ELEC MECH ASSY	RS5962
D24, D25	DIODE SCHOTTKY 10A 45V	BA0027
---	BDG RECT BR152 200V 15A	BC0210
---	MJ15024 NPN POWER TRANS TO3 @	BD0373
REG1,	VOLTAGE REG TL783CKC	BE0455
REG2,	REG LM340AT 5.0V	BE0491
---	M5X30MM PAN POZI SCREW	NA0094
---	M3 X 8MM PAN POZI BLCK SCRW	NA0130
---	NO6X5/8 PAN CROSS REC B ZINC	NA0373
---	M5 NYLON INSERT NUT	NB0116
---	NYLOCK NUT ZINC 6-32 UNIFIED	NB0173
---	M4 PLAIN STEEL WASHER ZNC CLR	NC0249
---	M4X9 1MM THICK RUBBER WASHER	NC0293
---	NO6 PLASTIC WASHER 1.58MM	NC0295
---	M3.5 NYLON BUSH	ND0392
---	FAN GASKET 80.00MM	NZ2357-02
---	CPS250/275 PSU HEATSINK	PN1261-01
---	CPS275 PSU PCB ASSY	RC3803B
---	UNIVERSAL FAN WFM	RV3142
---	TIP INS BUSH	ZC0215
---	KOOL PAD LM317T/337T	ZC0217
---	30CMX30CM THERMALLY CNDCTV SHT	ZC0223
---	KERATHERM 86/10 PAD	ZC0230
---	!FUSE COVER SCHURTER 853-9561 !	ZD8013
F3	!5X20MM T1A/250V AS FUSE !	ZD8101
F4	!5X20MM T2A/250V AS FUSE !	ZD8102
F1, F2	!5X20MM T10A/250V AS FUSE !	ZD8110

Module/PCB Assemblies

CPS250 PSU PCB ASSY

RC3803A

R22	MF 0.25W RES 2% 82R	AD0423
R34	MF 0.25W RES 2% 150R	AD0429
R32	MF 0.25W RES 2% 220R	AD0433
R3, R4	MF 0.25W RES 2% 270R	AD0435
R26	MF 0.25W RES 2% 510R	AD0442
R1, R2	MF 0.25W RES 2% 1K	AD0449
R15	MF 0.25W RES 2% 1K6	AD0454
R13, R14	MF 0.25W RES 2% 2K2	AD0457
R25	MF 0.25W RES 2% 2K7	AD0459
R35, R36, R37, R39, R40, R41 R42, R43, R50, R51, R52, R53 R54, R55	MF 0.25W RES 2% 3K3	AD0461
R23	MF 0.25W RES 2% 3K9	AD0463
R5, R6, R7, R8, R9, R10	MF 0.25W RES 2% 4K7	AD0465
R30, R31	MF 0.25W RES 2% 6K8	AD0469
R11, R12, R24	MF 0.25W RES 2% 7K5	AD0470
R16, R17, R28, R29	MF 0.25W RES 2% 100K	AD0497
R33	WW 4W 5% 33R	AH0739
R18, R19, R20, R21	WW RES 4W 10% OR22	AH0741
STD,	RES MF 10R 2% 0.25W RADIAL	AV0001
R46, R47, R48, R49	ZERO OHM RESISTOR (METAL SLUG)	AZ2222
D21	DIODE 1N4148	BA0001
D1, D2, D3, D4, D5, D6 D7, D8, D13, D14, D20	DIODE 1N4001	BA0005
D9, D10, D11, D12, D15, D16 D17, D18	DIODE 1N5402 200V 3A PRFMD .6"	BA0009
DZ1, DZ2	ZENER DIODE 400MW 9V1	BB0105
DZ5	ZENER DIODE 400MW 11V	BB0106
DZ3, DZ4	ZENER DIODE 400MW 15V	BB0107
TR5, TR6	NPN TRANS 2SC2240BL(TAPED)	BD0302
TR1, TR2, TR7	NPN TRANS BD135	BD0317
OP1, OP2	CNY17-1 OPTO-COUPLER	@ BD0348
IC1, IC2	V.REG LM723	BE0414
C25, C26	C/C0.2" TAPED 100V 470PF(N47)	CA0008
C1, C2, C3, C4, C5, C6 C7, C8, C9, C10, C11, C12 C13, C14, C27, C28, C29, C30 C32, C35, C37, C38	POLY-CAP 5MM 5% 63V 100N	CC0252
C42	VERT ELEC 0.2" TPD 47MF 25V	CE0401
C33	VERT ELEC 0.2" 47UF 63V	CE0402
C40, C41	VERT ELEC 0.2" TPD 100MF 10V	CE0403
C31	VERT ELEC 10MM 1000MF/100V	CE0426
C21, C22, C34	VERT ELEC 5MM 220MF/63V	CE0429
C15, C16, C18, C19	VERT ELEC 10MM 10,000MF/35V	CE0431
C39	VERT ELEC 1000MF 6.3V	CE0433
C23, C24	VERT ELEC 2200/25V 26X12MM	CE0460
C36	VERT ELEC 4700UF 35V 18X42MM	CE0481
PR1, PR2, PR3	CERMET TRIMMER HORIZ 9OH 2K2	DE0401
CN1	MTHD .1" 2WY VERT LCKNG ML HDR	FF0641
SP1,2,3	1/4" PC MNTNG BLADE VERT	FF0676
LED1,2,	MV5453 5MM GREEN LED DIFF	JA0065
D22, D23, D24, D25, STD	0.6MM DIA RL TIN COPPER WIRE	LF0568A

H1, H2, TR3, TR3C, TR4, TR4C	SELF CLINCHING FASTENER	NZ2317
TR1, TR2	POWER STATION DRIVER HEATSINK	PN1241
---	CPS250/275 PSU PCB	SC3803-03
LED1,2,	HOLDER FOR 5MM LED PC MNT	ZC0222
TR1, TR2	DRIVER MOUNTING CLIP	ZC0231
2 per f	!SCHURTER FUSE CLIP !	ZD0317

CPS275 PSU PCB ASSY

RC3803B

R22	MF 0.25W RES 2% 82R	AD0423
R34	MF 0.25W RES 2% 150R	AD0429
R32	MF 0.25W RES 2% 220R	AD0433
R3, R4	MF 0.25W RES 2% 270R	AD0435
R26	MF 0.25W RES 2% 510R	AD0442
R1, R2	MF 0.25W RES 2% 1K	AD0449
R15	MF 0.25W RES 2% 1K6	AD0454
R13, R14	MF 0.25W RES 2% 2K2	AD0457
R25	MF 0.25W RES 2% 2K7	AD0459
R35, R36, R37, R39, R40, R41 R42, R43, R50, R51, R52, R53 R54, R55	MF 0.25W RES 2% 3K3	AD0461
R23	MF 0.25W RES 2% 3K9	AD0463
R5, R6, R7, R8, R9, R10	MF 0.25W RES 2% 4K7	AD0465
R30, R31	MF 0.25W RES 2% 6K8	AD0469
R11, R12, R24	MF 0.25W RES 2% 7K5	AD0470
R16, R17, R28, R29	MF 0.25W RES 2% 100K	AD0497
R18, R19, R20, R21	W/W RES 4W 10% OR22	AH0741
OPA,	RES MF 10R 2% 0.25W RADIAL	AV0001
R38	ZERO OHM RESISTOR (METAL SLUG)	AZ2222
D21	DIODE 1N4148	BA0001
D1, D2, D3, D4, D5, D6 D7, D8, D13, D14, D20	DIODE 1N4001	BA0005
D9, D10, D11, D12, D15, D16 D17, D18	DIODE 1N5402 200V 3A PRFMD .6"	BA0009
D23	DIODE SCHOTTKY 3A 20V IN5820	BA0028
D22	DIODE SCHOTTKY 1.1A 60V 11DQ06	BA0029
DZ1, DZ2	ZENER DIODE 400MW 9V1	BB0105
DZ5	ZENER DIODE 400MW 11V	BB0106
DZ3, DZ4	ZENER DIODE 400MW 15V	BB0107
TR5, TR6	NPN TRANS 2SC2240BL(TAPED)	BD0302
TR1, TR2, TR7	NPN TRANS BD135	BD0317
OP1, OP2	CNY17-1 OPTO-COUPLER @	BD0348
IC1, IC2	V.REG LM723	BE0414
C25, C26	C/C0.2" TAPED 100V 470PF(N47)	CA0008
C1, C2, C3, C4, C5, C6 C7, C8, C9, C10, C11, C12 C13, C14, C27, C28, C29, C30 C32, C35, C37, C38	POLY-CAP 5MM 5% 63V 100N	CC0252
C42	VERT ELEC 0.2" TPD 47MF 25V	CE0401
C33	VERT ELEC 0.2" 47UF 63V	CE0402
C40, C41	VERT ELEC 0.2" TPD 100MF 10V	CE0403
C31	VERT ELEC 10MM 1000MF/100V	CE0426
C21, C22, C34	VERT ELEC 5MM 220MF/63V	CE0429
C15, C16, C17, C18, C19, C20	VERT ELEC 10MM 10,000MF/35V	CE0431
C39	VERT ELEC 1000MF 6.3V	CE0433
C36	VERT ELEC 4700MF/50V(22MM DIA)	CE0450
C23, C24	VERT ELEC 2200/25V 26X12MM	CE0460
PR1, PR2, PR3	CERMET TRIMMER HORIZ 9OH 2K2	DE0401

CN1	MTHD .1" 2WY VERT LCKNG ML HDR	FF0641
SP1,2,3	1/4" PC MNTNG BLADE VERT	FF0676
LED1,2,	MV5453 5MM GREEN LED DIFF	JA0065
OPA,	0.6MM DIA RL TIN COPPER WIRE	LF0568A
H1, H2, TR4, H4C, H3, H3C	SELF CLINCHING FASTENER	NZ2317
TR1, TR2	POWER STATION DRIVER HEATSINK	PN1241
---	CPS250/275 PSU PCB	SC3803-03
LD1, LD2, LD3	HOLDER FOR 5MM LED PC MNT	ZC0222
TR1, TR2	DRIVER MOUNTING CLIP	ZC0231
F1, F2, F3, F4	!SCHURTER FUSE CLIP	! ZD0317