

ALIGNMENT INSTRUCTIONS

A) EQUIPMENT NEEDED

1. AM Signal Generator
2. FM Signal Generator
3. IF Sweep Generator
4. FM Stereo Signal Generator
5. Marker Generator
6. Oscilloscope
7. Output Meter (VTVM)
8. Distortion Meter
9. Frequency Counter

B) IMPORTANT

1. For AM Alignment apply 400 Hz modulation on the Signal Generator and radiated signal.
2. Connect a VTVM or a circuit tester to voice coil.
 Connection may be made by means of a stiff wire in the speaker pin jack, and by using lead wire with plug.
 Adjust as in the tables below, for maximum meter reading.
 When necessary, reduce the oscillator output so that meter reading does not exceed 2 V.
3. Be sure to see the performance after casing the unit re-aligned.
4. After alignment had been completed all coil slugs and trimmers that have been moved during alignment should be rewaxed to insure stability of operation.
5. Use only nonmetallic alignment tools to insure proper alignment.

C) AM Section

Circuit Alignment	Equipment Connection	Step	Gen. Freq.	Dial Setting	Adjustments
IF	AM SIGNAL GENERATOR Radiated Signal. OUTPUT METER (VTVM) Across 8 ohm (See Fig. - 1)	1	455 kHz (Mod.)	Tuning gang fully closed	AM IFT – T202, T203, T205 Adjust for maximum output.
		2	—	—	Repeat until no further improvement can be made.
BAND	AM SIGNAL GENERATOR Radiated Signal. OUTPUT METER (VTVM) Across 8 ohm (See Fig. - 1)	3	525 kHz (Mod.)	Tuning gang fully closed	T102 (AM Osc. coil) Adjust for maximum output.
		4	1650 kHz (Mod.)	Tuning gang fully opened	TC102 (AM Osc. trimmer) Adjust for maximum output.
		5	—	—	Repeat steps 3 and 4.

TRACKING	AM SIGNAL GENERATOR Radiated Signal. OUTPUT METER (VTVM) Across-8 ohm (See Fig. - 1)	6	600 kHz	Tune to signal	L105 (AM Ant. coil) Adjust coil on ferrite core for maximum output.
		7	1400 kHz	— " —	TC101 (AM Ant. trimmer) Adjust for maximum output.
		8	—	— " —	Repeat steps 6 and 7.

D) FM Section

Circuit Alignment	Equipment Connection	Step	Gen. Freq.	Dial Setting	Adjustments
IF	IF SWEEP GENERATOR FM ANT TERMINAL MARKER GENERATOR The same as Sweep Generator OSCILLOSCOPE Across Point TP202 (See Fig. - 2)	1	10.7MHz	Tuning gang fully closed.	FM IFT - T201, T204, T206. Adjust for maximum symmetrical response. (10.7 MHz at the center point)
		2			Repeat Step 1.
RATIO DET.		3	10.7MHz (Mod.)	Tuning gang fully closed	FM IFT - T207 Adjust for suitable "S" curve.
		4			Repeat Step 3.
BAND	FM SIGNAL GENERATOR FM ANT TERMINAL OUTPUT METER (VTVM) Across 8 ohm Load. (See Fig. - 3)	5	86 MHz (Mod.)	Tuning gang fully closed	(FM OSC. coil L104) Adjust for maximum output.
		6	110MHz (Mod.)	Tuning gang fully opened	(FM OSC. Trimmer) TC104 Adjust for maximum output.
		7			Repeat Step 5 and 6.
TRACKING		8	90 MHz (Mod.)	Tune to signal	(FM. RF Coil) L102 Adjust for maximum output.
		9	106MHz (Mod.)	Tune to signal	(FM. RF. trimmer) TC104 Adjust for maximum output.
		10			Repeat steps 8 and 9 obtain suitable sensitivity at 90 MHz and 106 MHz.

E) FM MPX.

Circuit Alignment	Equipment Connection	Step	Gen. Freq.	Dial Setting	Alignment
19 KHz Adjustment	Connect the Freq. Counter to TP301. (Test point) (See Schematic Diagram) (See Fig. - 4)	1		Tune away from stereo station	First make sure FM Section is properly aligned. Adjust VR302 till the Freq. Counter indicates 19 kHz.
CHANNEL SEPARATION	FM STEREO GEN. FM SIGNAL GEN. Composite out connect to Ext. Mod. of FM Signal Generator. FM SIGNAL GEN. Connect to T101 (Ant. Terminal). DIST. METER (VTVM) Across 8 ohm (See Fig. - 5)	2	98 MHz	98 MHz	Adjust VR301 for minimum. Output from left (right) Channel when right (left) Channel is modulated. Channel separation should be not less than 20dB.

F) TUNING METER

Circuit Alignment	Dial Setting	Step	Alignment
Zero Setting	Set Function Switch to A.M. Tuning gang Fully Closed	1	Adjust VR201 for zero reading on tuning meter.

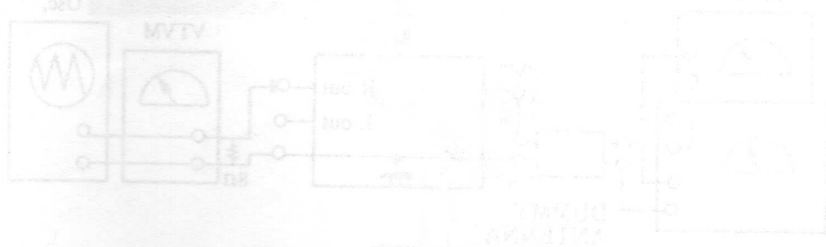

EQUIPMENT CONNECTION

(Fig. - 1)
AM BAND TRACKING

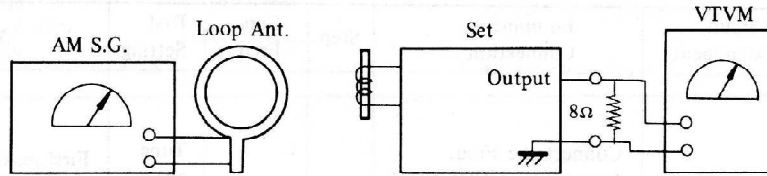

(Fig. - 2)
FM IF RATIO DET.

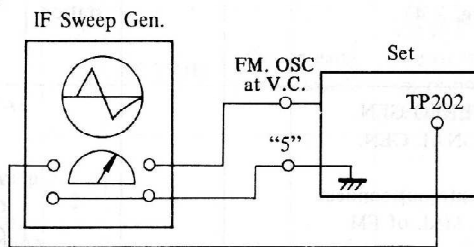

(Fig. - 3)
FM BAND TRACKING

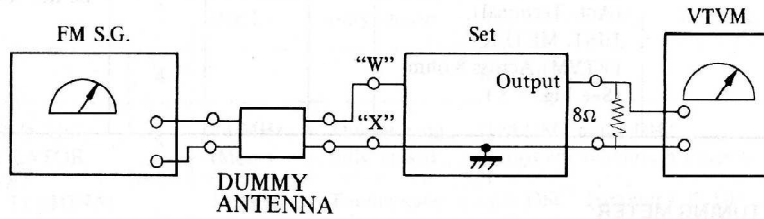

(Fig. - 4)
19KHz Adjustment

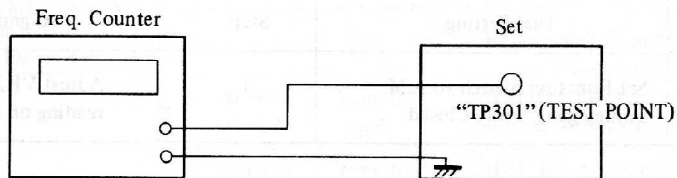

(Fig. - 5)
MPX SEPARATION

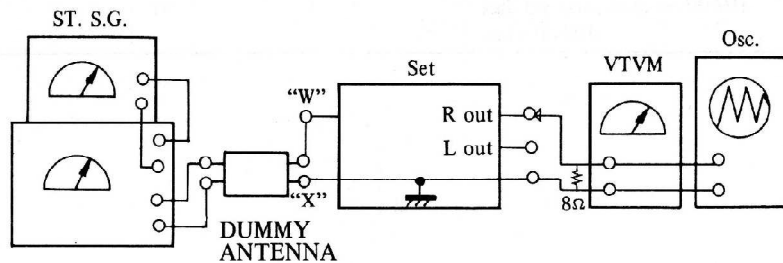

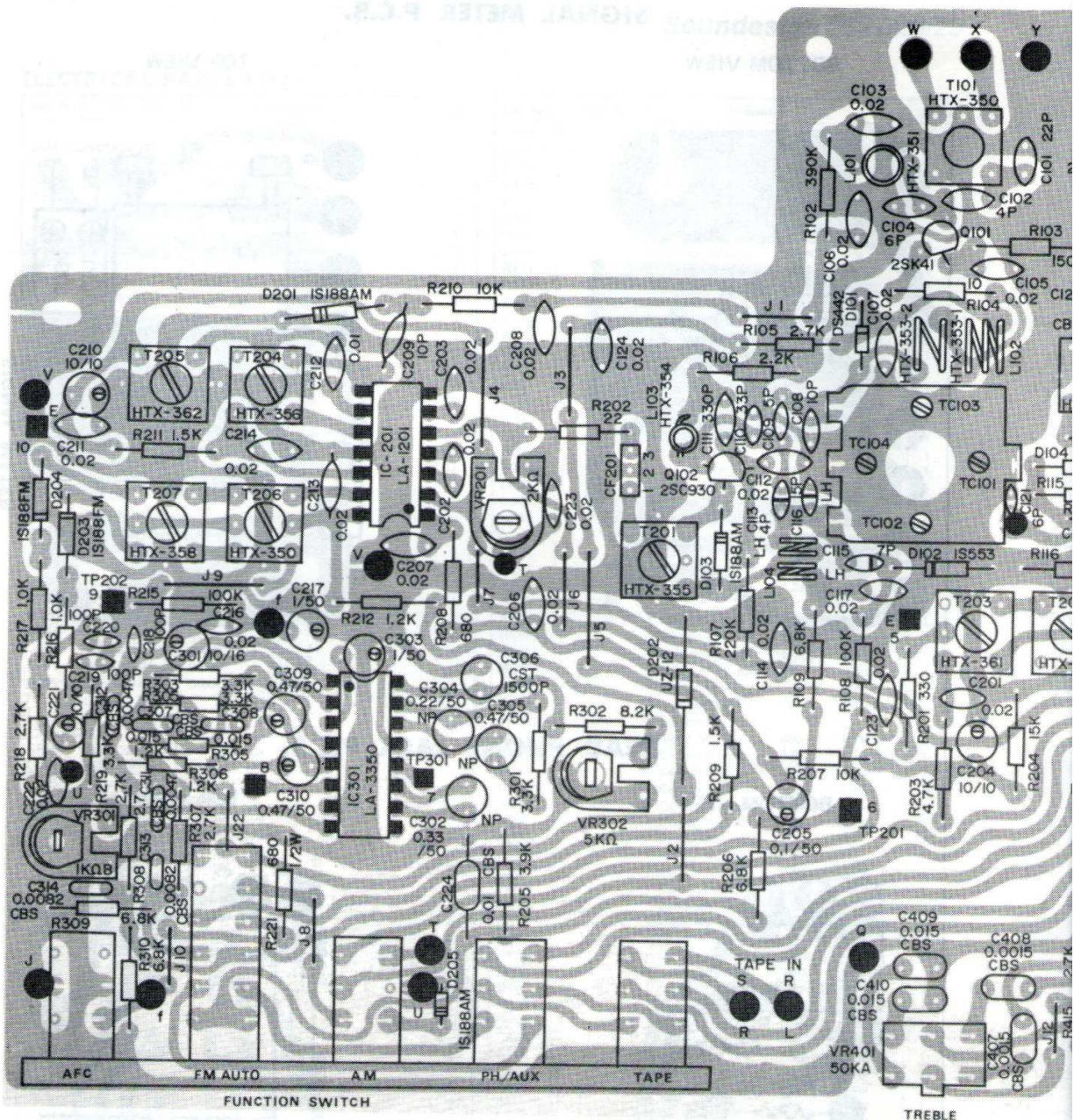

1M-345-WT

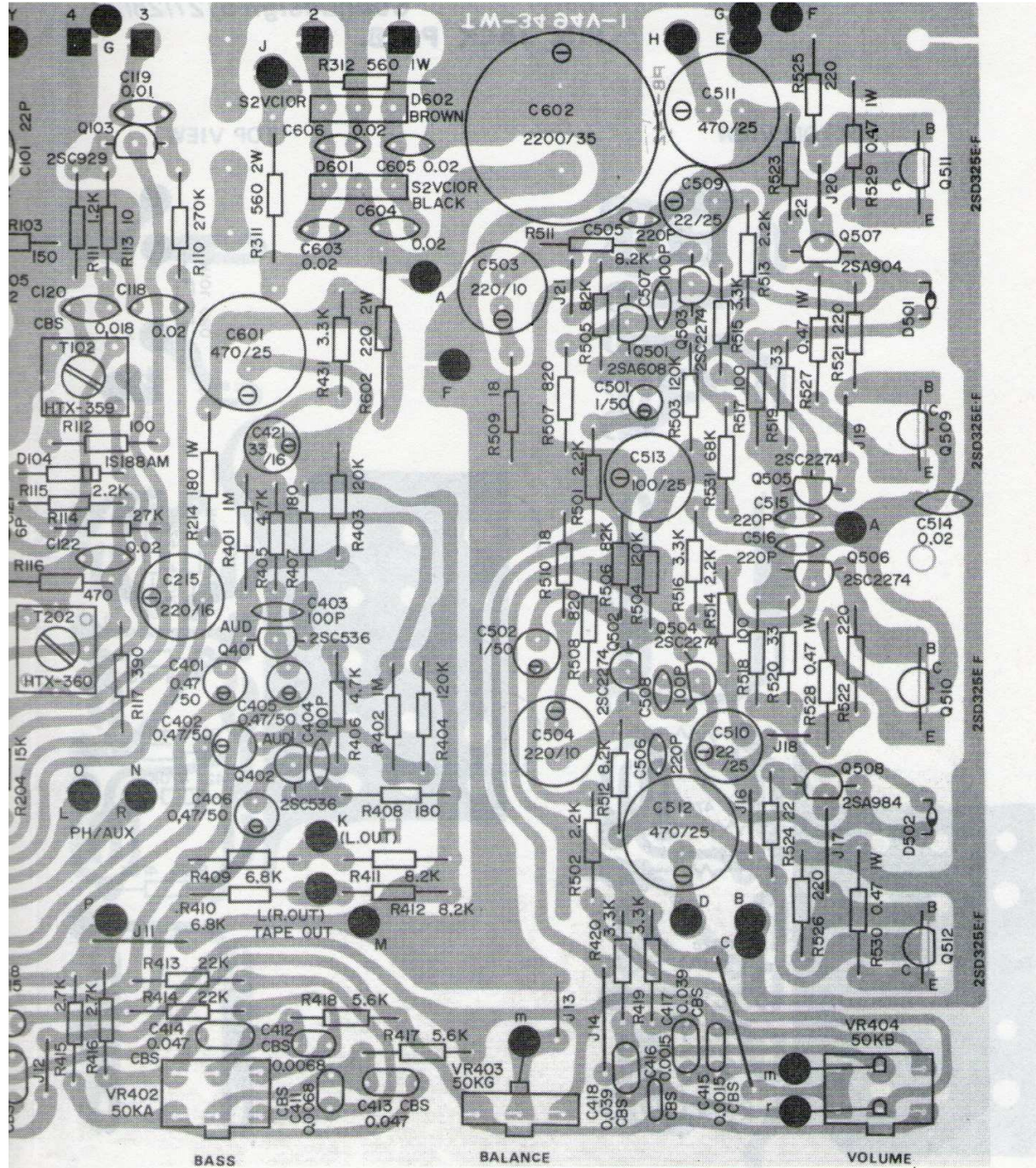

BASS

BALANCE

VOLUME

2SD325E-F

2SD325E-F

2SD325E-F

2SD325E-F

Soundesign 5127/28/29
PIN JACK P.C.B.

BOTTOM VIEW

TOP VIEW

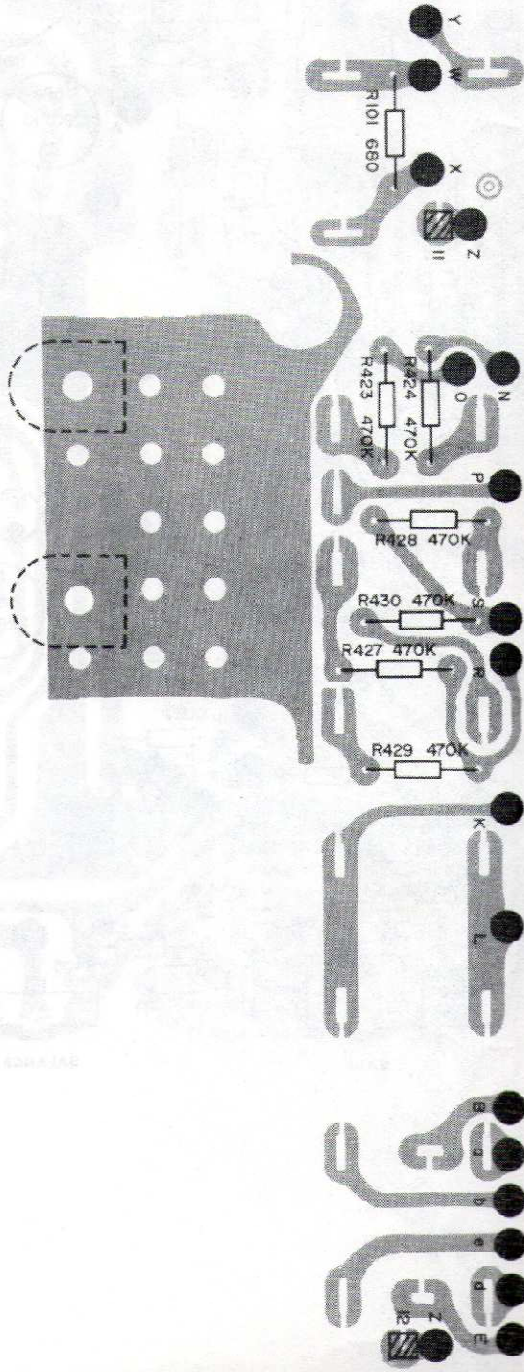
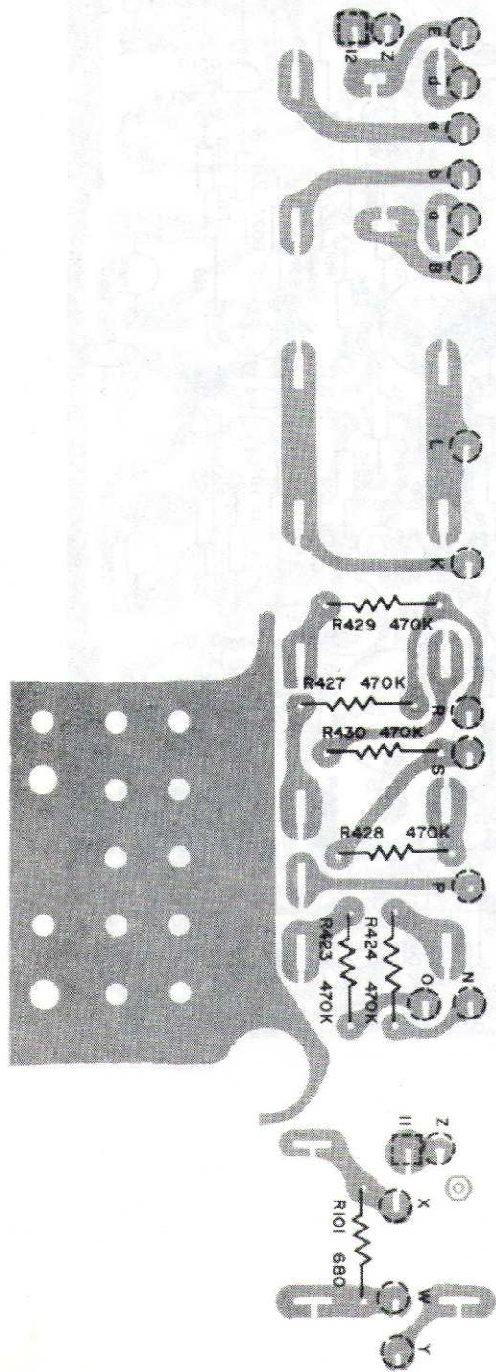

SIGNAL METER P.C.B.

BOTTOM VIEW

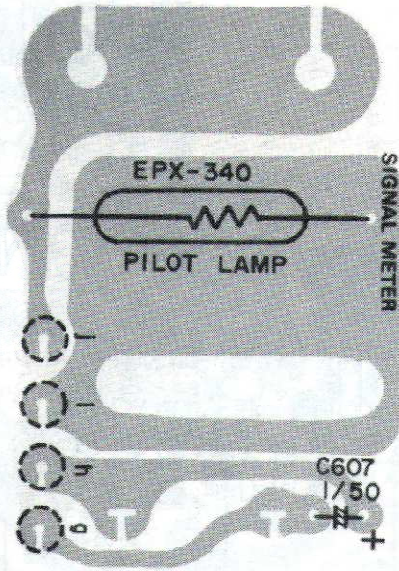

TOP VIEW

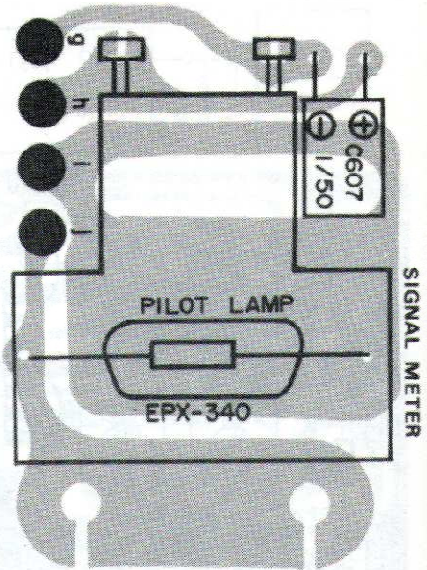

HEAD PHONE JACK P.C.B.

BOTTOM VIEW

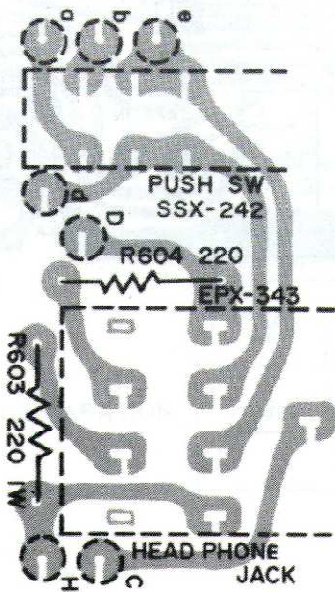

TOP VIEW

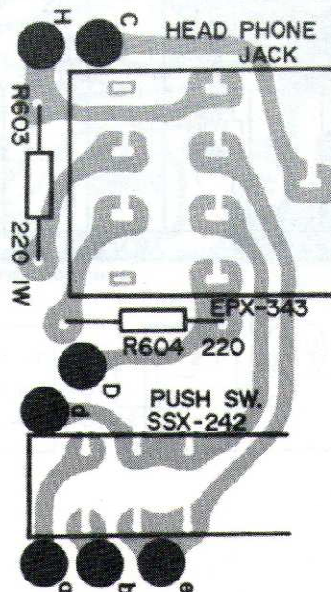

Ref. No.	Part No.	Description	Qty.	Ref. No.	Part No.	Description	Qty.
R419		Carbon Resistor 3.3K 1/4W	1	C118		Ceramic Capacitor 0.02μF	1
R420		Carbon Resistor 3.3K 1/4W	1	C119		Ceramic Capacitor 0.01μF	1
R421		—		C120		Mylar 0.018μF	1
R422		—		C121		Ceramic Capacitor 6PF	1
R423		Carbon Resistor 470K 1/4W	1	C122		Ceramic Capacitor 0.02μF	1
R424		Carbon Resistor 470K 1/4W	1	C123		Ceramic Capacitor 0.02μF	1
R425		—		C124		Ceramic Capacitor 0.02μF	1
R426		—		C201		Ceramic Capacitor 0.02μF	1
R427		Carbon Resistor 470K 1/4W	1	C202		Ceramic Capacitor 0.02μF	1
R428		Carbon Resistor 470K 1/4W	1	C203		Ceramic Capacitor 0.02μF	1
R429		Carbon Resistor 470K 1/4W	1	C204		Elec. Capacitor 10μF/10V	1
R430		Carbon Resistor 470K 1/4W	1	C205		Elec. Capacitor 0.1μF/50V	1
R431		Carbon Resistor 3.3K 1/4W	1	C206		Ceramic Capacitor 0.02μF	1
R501		Carbon Resistor 2.2K 1/4W	1	C207		Ceramic Capacitor 0.02μF	1
R502		Carbon Resistor 2.2K 1/4W	1	C208		Ceramic Capacitor 0.02μF	1
R503		Carbon Resistor 120K 1/4W	1	C209		Ceramic Capacitor 10PF	1
R504		Carbon Resistor 120K 1/4W	1	C210		Elec. Capacitor 10μF/10V	1
R505		Carbon Resistor 82K 1/4W	1	C211		Ceramic Capacitor 0.02μF	1
R506		Carbon Resistor 82K 1/4W	1	C212		Ceramic Capacitor 0.01μF	1
R507		Carbon Resistor 820 1/4W	1	C213		Ceramic Capacitor 0.02μF	1
R508		Carbon Resistor 802 1/4W	1	C214		Ceramic Capacitor 0.02μF	1
R509		Carbon Resistor 18 1/4W	1	C215		Elec. Capacitor 220μF/16V	1
R510		Carbon Resistor 18 1/4W	1	C216		Ceramic Capacitor 0.02μF	1
R511		Carbon Resistor 8.2K 1/4W	1	C217		Elec. Capacitor 1μF/50V	1
R512		Carbon Resistor 8.2K 1/4W	1	C218		Ceramic Capacitor 100PF	1
R513		Carbon Resistor 2.2K 1/4W	1	C219		Ceramic Capacitor 100PF	1
R514		Carbon Resistor 2.2K 1/4W	1	C220		Ceramic Capacitor 100PF	1
R515		Carbon Resistor 3.3K 1/4W	1	C221		Elec. Capacitor 10μF/10V	1
R516		Carbon Resistor 3.3K 1/4W	1	C222		Ceramic Capacitor 0.02μF	1
R517		Carbon Resistor 100 1/4W	1	C223		Ceramic Capacitor 0.02μF	1
R518		Carbon Resistor 100 1/4W	1	C224		Mylar 0.01μF	1
R519		Carbon Resistor 33 1/4W	1	C301		Elec. Capacitor 10μF/16V	1
R520		Carbon Resistor 33 1/4W	1	C302		Elec. Capacitor 0.33μF/50V (H.P)	1
R521		Carbon Resistor 220 1/4W	1	C303		Elec. Capacitor 1μF/50V	1
R522		Carbon Resistor 220 1/4W	1	C304		Elec. Capacitor 0.22μF/50V (H.P)	1
R523		Carbon Resistor 22 1/4W	1	C305		Elec. Capacitor 0.47μF/50V (H.P)	1
R524		Carbon Resistor 22 1/4W	1	C306		Styrol 1500PF	1
R525		Carbon Resistor 220 1/4W	1	C307		Mylar 0.015μF	1
R526		Carbon Resistor 220 1/4W	1	C308		Mylar 0.015μF	1
R527		Metal Resistor 0.47 1W	1	C309		Elec. Capacitor 0.47μF/50V	1
R528		Metal Resistor 0.47 1W	1	C310		Elec. Capacitor 0.47μF/50V	1
R529		Metal Resistor 0.47 1W	1	C311		Mylar 0.0047μF	1
R530		Metal Resistor 0.47 1W	1	C312		Mylar 0.0047μF	1
R531		Carbon Resistor 68K 1/4W	1	C313		Mylar 0.0082μF	1
R601		Solid Resistor 2.2MΩ 1/2W	1	C314		Mylar 0.0082μF	1
R602		Metal Resistor 220 2W	1	C401		Elec. Capacitor 0.47μF/50V	1
R603		Metal Resistor 220 1W	1	C402		Elec. Capacitor 0.47μF/50V	1
R604		Metal Resistor 220 1W	1	C403		Ceramic Capacitor 100PF	1
C101		Ceramic Capacitor 22PF	1	C404		Ceramic Capacitor 100PF	1
C102		Ceramic Capacitor 4PF	1	C405		Elec. Capacitor 0.47μF/50V	1
C103		Ceramic Capacitor 0.02μF	1	C406		Elec. Capacitor 0.47μF/50V	1
C104		Ceramic Capacitor 6PF	1	C407		Mylar 0.0015μF	1
C105		Ceramic Capacitor 0.02μF	1	C408		Mylar 0.0015μF	1
C106		Ceramic Capacitor 0.02μF	1	C409		Mylar 0.015μF	1
C107		Ceramic Capacitor 0.02μF	1	C410		Mylar 0.015μF	1
C108		Ceramic Capacitor 10PF	1	C411		Mylar 0.0068μF	1
C109		Ceramic Capacitor 5PF	1	C412		Mylar 0.0068μF	1
C110		Ceramic Capacitor 33PF	1	C413		Mylar 0.047μF	1
C111		Ceramic Capacitor 330PF	1	C414		Mylar 0.047μF	1
C112		Ceramic Capacitor 0.02μF	1	C415		Mylar 0.0015μF	1
C113		Ceramic Capacitor 4PF	1	C416		Mylar 0.0015μF	1
C114		Ceramic Capacitor 0.02μF	1	C417		Mylar 0.039μF	1
C115		Ceramic Capacitor 7PF	1	C418		Mylar 0.039μF	1
C116		Ceramic Capacitor 15PF	1	C419			
C117		Ceramic Capacitor 0.02μF	1	C420			
				C421		Elec. Capacitor 33μF/16V	1

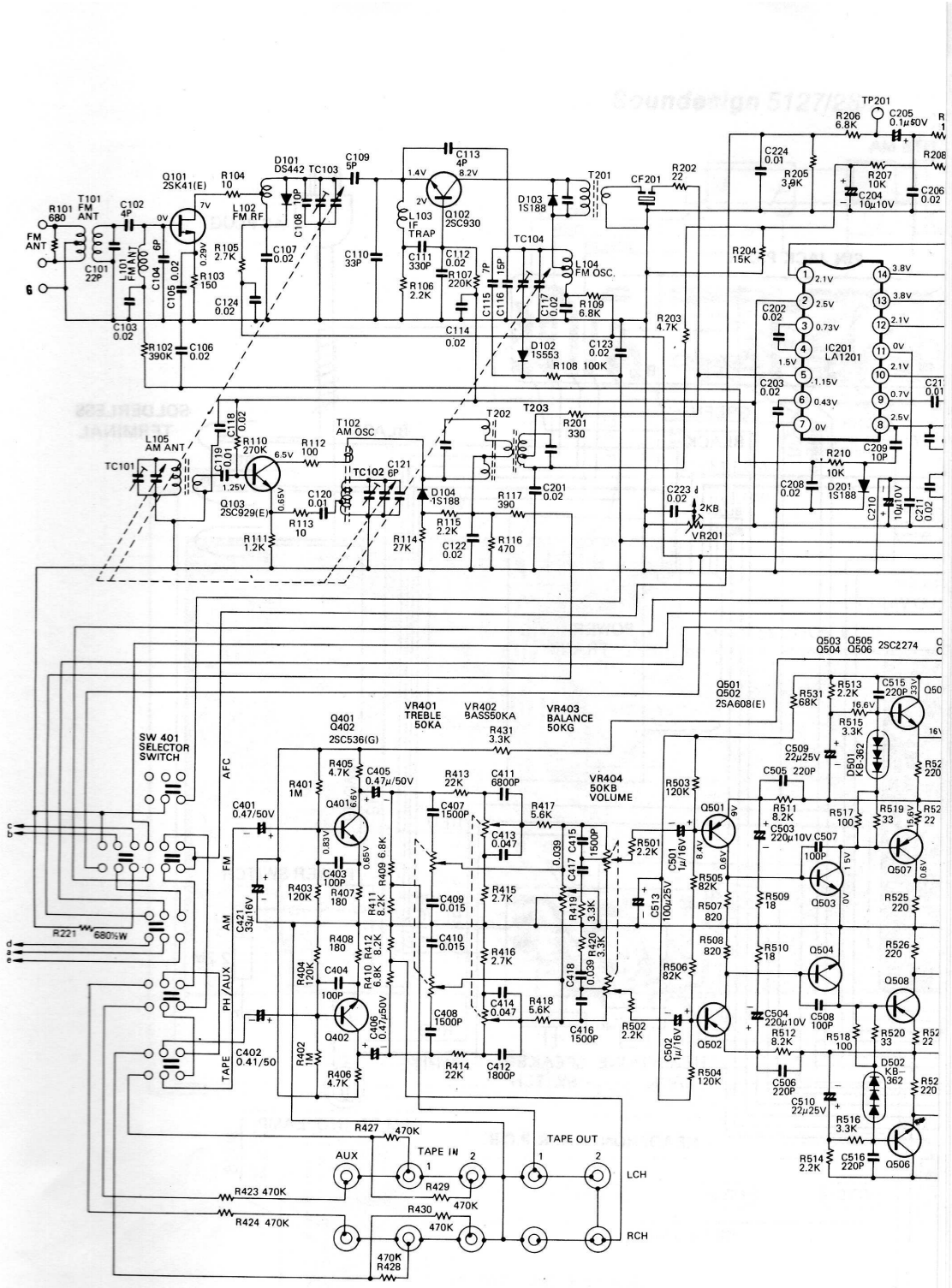

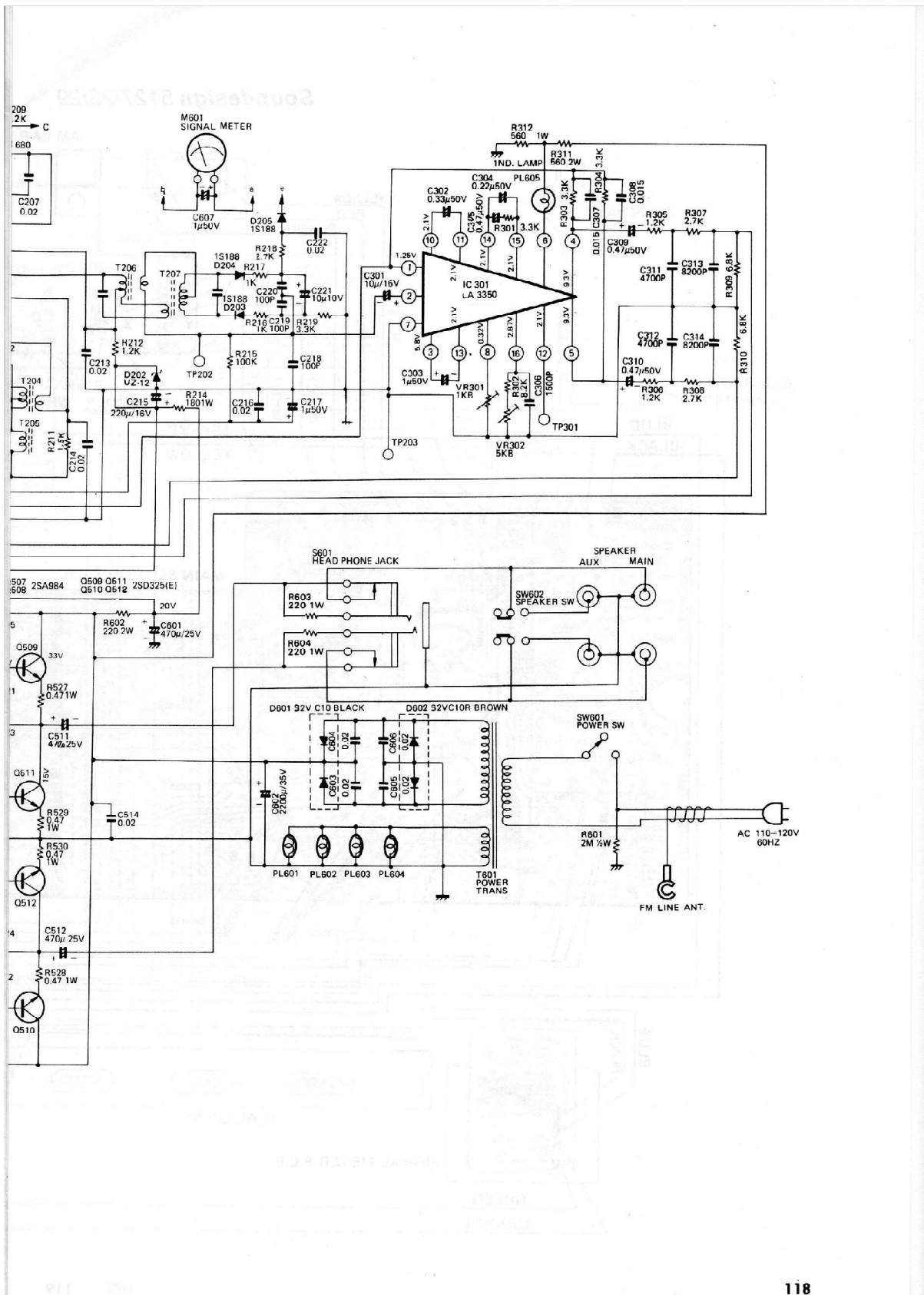

Soundesign 5127/28/29

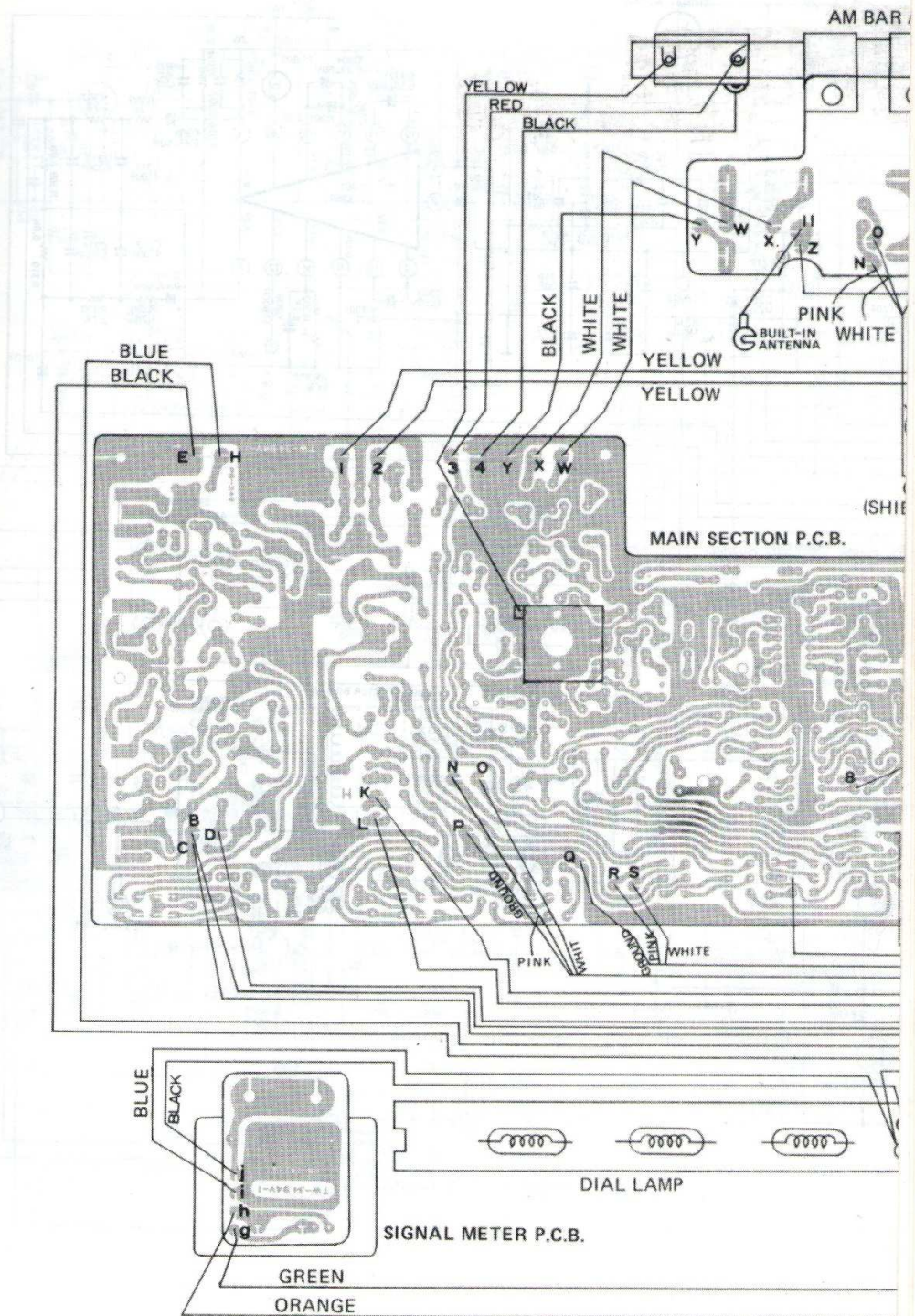

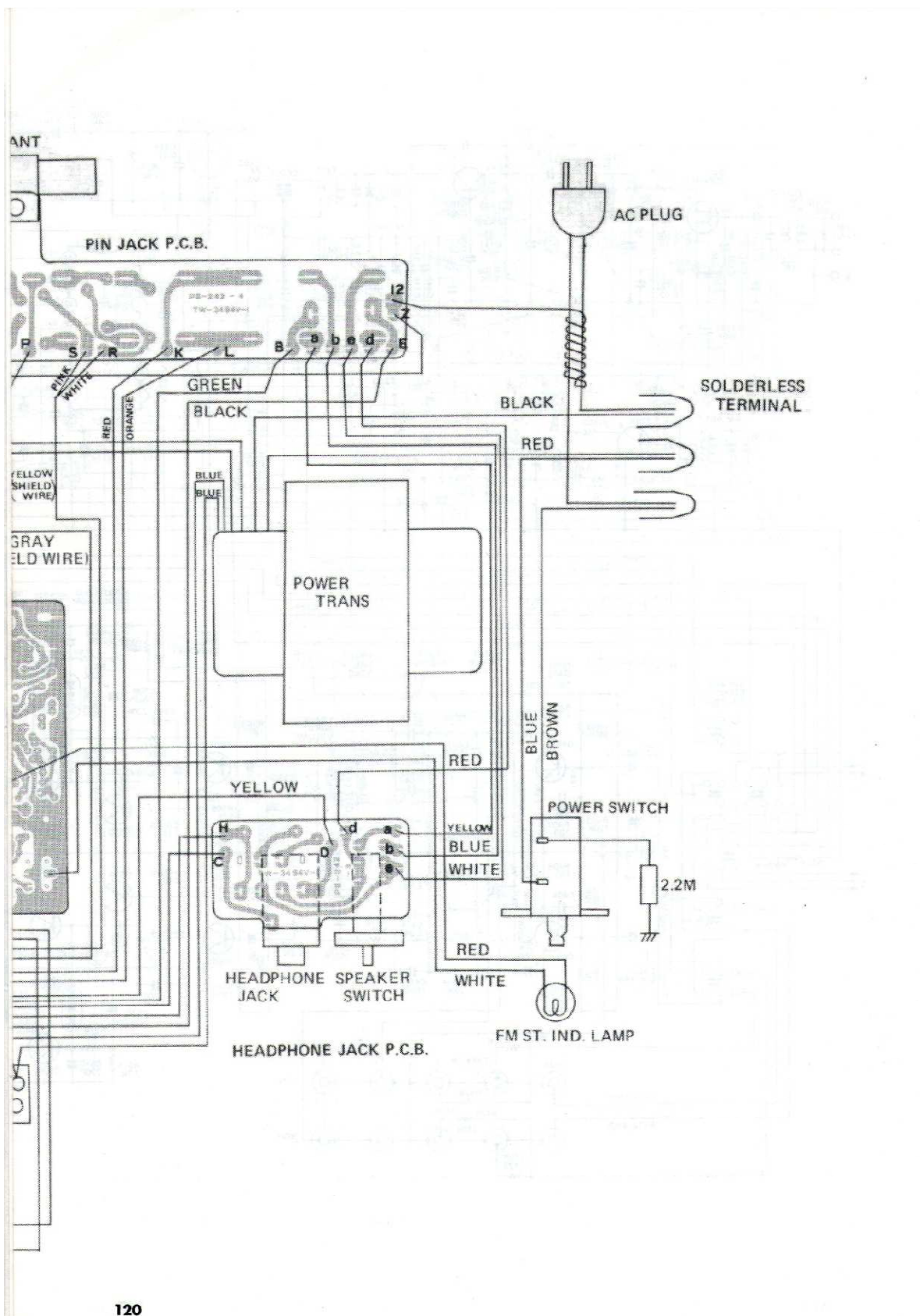

MECHANICAL PARTS LIST
CHASSIS GROUP

Ref. No.	Part No.	Description	Qty.	Item No.	Part No.	Description	Qty.
C501		Ele. Capacitor 1μF/50V	1		CHS-1003H	Front Chassis	1
C502		Ele. Capacitor 1μF/50V	1		DLM-229	Dial Pulley (Doubler)	2
C503		Ele. Capacitor 220μF/10V	1		DLS-389	Pully Shaft	2
C504		Ele. Capacitor 220μF/10V	1		DLM-235	Dial Scale /5127 only	1
C505		Ceramic Capacitor 220PF	1		DLM-235-B	Dial Scale/5128 only	1
C506		Ceramic Capacitor 220PF	1		DLM-235-C	Dial Scale/5129 only	1
C507		Ceramic Capacitor 100PF	1		MPM-424	Lens	1
C508		Ceramic Capacitor 100PF	1		DLA-243	Driving Shaft Ass.	1s
C509		Ele. Capacitor 22μF/25V	1			9N	1
C510		Ele. Capacitor 22μF/25V	1			9.5 x 14 x 0.5t W	1
C511		Ele. Capacitor 470μF/25V	1		DLS-396H	G.W. Bracket (R)	1
C512		Ele. Capacitor 470μF/25V	1		DLS-397H	G.W. Bracket (L)	1
C513		Ele. Capacitor 100μF/25V	1		DLM-204	Pulley	2
C514		Ceramic Capacitor 0.02μF	1		DLS-293	Pulley Screw	2
C515		Ceramic Capacitor 220PF	1		DLM-231H	Pointer	1
C516		Ceramic Capacitor 220PF	1		DLS-340	Tension Spring	1
C601		Ele. Capacitor 470μF/25V	1		DLM-232	Dial Wheel (Drum)	1
C602		Ele. Capacitor 2200μF/35V	1			Dial String	1
C603		Ceramic Capacitor 0.02μF	1		CHS-1004H	Trans Supporter	1
C604		Ceramic Capacitor 0.02μF	1		CHS-1005H	Side Plate	1
C605		Ceramic Capacitor 0.02μF	1		CHS-1006H	Rear Plate	1
C606		Ceramic Capacitor 0.02μF	1		CHS-1007	Radiator (Heat Sink)	1
C607		Ele. Capacitor 1μF/10V	1		CFM-315H	Decoration Panel /5127 only	1
					CFM-315H-B	Decoration Panel/5128 only	1
					CFM-315H-C	Decoration Panel/5129 only	1
					CHS-982	Reflector	1
					MPM-135H	Antenna Holder	2
					CHS-1008	Scale Support	1
					WAS-102	Square Washer	2
						4 x 12 CPS	2
						4 N	2
						4 Sw	2
						3 x 6 CPS	6
						2.5 x 4 CPS	2
						2.6 x 6 CPS	1
						2.6 SW	1
					CHS-1009H	Screw Angle	2
						3 x 8 CBrTS	4
						3 x 8 CBrTS	1
						3 x 8 CBrTS	4
						3 x 8 CBrTS	5
						3 x 8 CBrTS	2
						3 x 8 CBrTS	2
						3 x 8 CBrTS	2
						3 x 6 CPTS	3
						3 x 6 CPS	1
						3 x 8 CPS	1
						3 N	5
						3 x 20 CPS	6
						3 N	2
						3 TW-A	2
						2.6 x 5 CPTS	2
							1
					MPH-168-A	Lamp Holder	1
						3 x 6 CPS	1
						Wood Spacer 42x12x9 m/m	1
					RDX-103	Meter Scale/5127 only	1
					RDX-103B	Meter Scale/5128 only	1
					RDX-103C	Meter Scale/5129 only	1
							1

CABINET GROUP

Item No.	Part No.	Description	Qty.
	CFS-296H	Ornament Panel/5127 only	1
	CFS-296H-B	Ornament Panel/5128 only	1
	CFS-296H-C	Ornament Panel/5129 only (BRONZE)	1
	CFM-314	Dial Cover	1
	CFS-286	Decoration Plate/5127 only	1
	CFS-286-B	Decoration Plate/5128 only	1
	CFS-286-C	Decoration Plate/5129 only (BRONZE)	1
	MPM-435	Push Knob Guide	1
	CMF-313	Decoration Plate Holder	1
	MPM-436	Tuning Knob /5127 only	1
	MPM-436-B	Tuning Knob /5128 only	1
	MPM-436-C	Tuning Knob /5129 only (BRONZE)	1
	MPM-437	Rotary Knob (A)/5127 only	3
	MPM-437-B	Rotary Knob (A)/5128 only	3
	MPM-437-C	Rotary Knob (A)/5129 only (BRONZE)	3
	MPM-438	Rotary Knob (B)/5127 only	1
	MPM-438-B	Rotary Knob (B)/5128 only	1
	MPM-438-C	Rotary Knob (B)/5129 only (BRONZE)	1
	MPM-439	Push Knob (A)/5127 only	6
	MPM-439-B	Push Knob (A)/5128 only	6
	MPM-439-C	Push Knob (A)/5129 only (BRONZE)	6
	MPM-440	Push Knob (B)/5127 only	1
	MPM-440-B	Push Knob (B)/5128 only	1
	MPM-440-C	Push Knob (B)/5129 only (BRONZE)	1
	CAW-303	Main Cabinet/5127 & 5129 only	1
	CAW-303-B	Main Cabinet/5128 only	1
	CFW-271	Back Board/5127 only	1
	CFW-271-B	Back Board/5128 only	1
	CFW-272	Back Board/5129 only	1
	MPM-288H	Foot	4
		3 x 13 ¹⁰ x 0.5t W	2
		3 x 13 CPTS	2
		4 x 25 CPS	6
	WAS-104	Claw Washer	4
		4 x 13 ¹⁰ x 0.8t W	2
		3 x 6 CPTS	6
	PAW-72D	Fiber	2

