

CONTENTS :

1	Safety and warranty.....	2
	1.1 Safety.....	2
	1.2 Warranty.....	2
2	Description of the SA 1600/800.....	5
3	Taking the SA 1600/800 apart.....	6
4	Basic diagram and internal wiring.....	8
5	Basic operation of the electronics.....	10
	5.1 Input and protection circuitry.....	10
	5.2 Power supply circuit.....	11
	5.3 Power amplifier.....	12
6	Circuit layouts	
	Front board.....	15
	Power supply board.....	17
	SA 1600 power amplifier board.....	20
	SA 800 power amplifier board.....	23
	Connector board.....	25
7	Adjustments.....	27
8	Final tests.....	29
9	Specifications.....	32
10	List of drawings.....	34
11	Modifications (supplement 1).....	35
	11.1 Power Supply.....	35
	11.2 Power Amplifier.....	35
12	80 MM fan update.....	36
	12.1 General description.....	36
	12.2 Power supply board.....	36
	12.3 Front board.....	36

This manual contains confidential information. Any form of duplication is prohibited !

1 SAFETY AND WARRANTY

1.1 SAFETY

-Warning

Inside the SA 1600/800, AC voltages up to 240 V may be present !

-Connection to the mains voltage

The SA 1600/800 chassis is connected to ground by the grounding conductor in the power cord. To avoid electrical shock, plug the power cord into a properly wired receptacle. When this ground connection is not present or interrupted, all accessible parts of the amplifier can cause an electrical shock.

-Fuses

To avoid fire hazard, only replace fuses by the same type and value.

-Servicing

Do not perform internal service or adjustments unless there is another person present, capable of rendering first aid and reanimation.

Try to perform all service work with mains power off. Remove mains plug to be sure that there are no internal voltages present.

1.2 WARRANTY

SUMMARY

Stage Accompany warrants to the original commercial purchaser of each new Stage Accompany product, from the date of purchase by the original purchaser until the end of the warranty period, that the product is free of defects in materials or workmanship.

WARRANTY PERIOD

The warranty period on all Stage Accompany products is five years from the date of the first consumer purchase, with the exception of:

- all electrical products: three years from the date of the first consumer purchase;
- cone assemblies in the loudspeaker and diaphragms in the Compact Drivers: one year from the date of the first consumer purchase;

- movable parts, such as castors, locks, handles, hinges, fans, etc: one year from the date of the first consumer purchase;
- computers and associated peripherals: six months from the date of the first consumer purchase.

HOW TO VALIDATE THE WARRANTY

To validate warranty, customers should fill out the enclosed warranty card and return it to Stage Accompany within ten days of the purchase date.

The purchaser must always keep the original bill of sale to establish the date of purchase.

ITEMS EXCLUDED FROM WARRANTY

Appeal on warranty will be voided in case :

- of defects caused by influence from the outside, accident, misuse, neglect or influence of water;
- the serial number on the warranty and/or product has been defaced, altered or removed;
- of damage due to shipment;
- of damage resulting from neglection of instructions listed in the user manual;
- of damage caused by incorrect, abnormal or abuse during delivery;
- the unit has been repaired (or shown signs of repair) by someone not authorised by Stage Accompany;
- if the warranty registration card has not been returned to Stage Accompany within 10 days of purchase;
- the original bill of sale can not be presented whenever warranty service is required;
- the cause of damage is unknown

WHAT WE WILL DO

Shipment of the product to a Stage Accompany dealer is at the risk and responsibility of the customer.

Stage Accompany will pay all labour and material expenses for all repairs covered by this warranty. Stage Accompany will not pay the cost of shipment to the Stage Accompany dealer or to the factory. However Stage Accompany will pay the return shipping charges if repairs are covered by the warranty.

SA 1600/800
SERVICE MANUAL

page: 4
date: 20-08-1990
issue: 1

CAUTION

Warranty work can only be performed at our authorised service centers or at our factory. Every repair or attempted repair by a non authorised party will void the warranty.

Stage Accompany reserves the right to alter specifications without prior notice.

2 DESCRIPTION OF THE SA 1600/800

The SA 1600/800 is a high power, high efficiency power amplifier. It features:

-high power

Peak power output varies from 2 x 440 W / 8 Ω to 2 x 1100 W / 2 Ω .

Continuous output power up to 2 x 640 W / 2 Ω .

The SA 800 features a peak output power from 2 x 220 W / 8 Ω to 2 x 550 W / 2 Ω and continuous power up to 2 x 300 W / 2 Ω .

-high efficiency

Heat dissipation is reduced by a 1000 Watts (SA 1600) compared to conventional designs.

-small size, medium weight

Very compact design, only 2 units high. The efficient design has reduced the weight to 17 kg (SA 800: 15 kg)!

-balanced input

The input is electronically balanced for excellent hum and noise rejection.

-speakon output connectors

Each channel is equipped with two high current 4 pole Neutrik Speakon output connectors.

-easy use of the bridge mode facility

Bridge mode switch and separate bridge mode output makes rewiring unnecessary.

-reduced inrush current

Mains inrush current is less than 5 Ampere! No need for delay turn on when multiple units are used.

3 TAKING THE SA 1600/800 APART

The SA 1600 and the SA 800 can be taken apart in the following way:

Access to the electronics can be obtained by removing the top panel. Remove the eight screws at the top and the two screws on the left and right side of the amplifier. See figure 1.

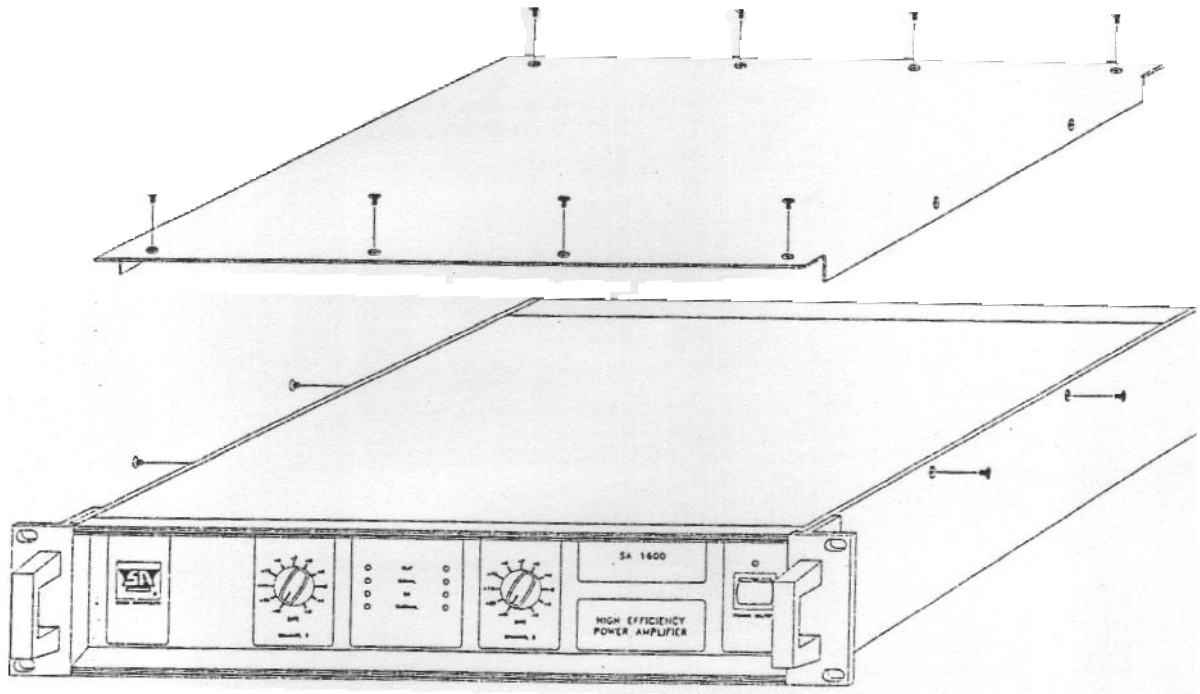

Fig 1 Removing the top panel.

Then, lift off the top panel.

To obtain access to the front panel, remove the bar on top of the front by removing a screw on the left and right side of the amplifier (see fig. 2).

After removing the connectors to the front board and the mains switch, the front panel can be taken out.

The back panel can be taken out in a similar way.

However, for most servicing work, this panel does not need to be removed.

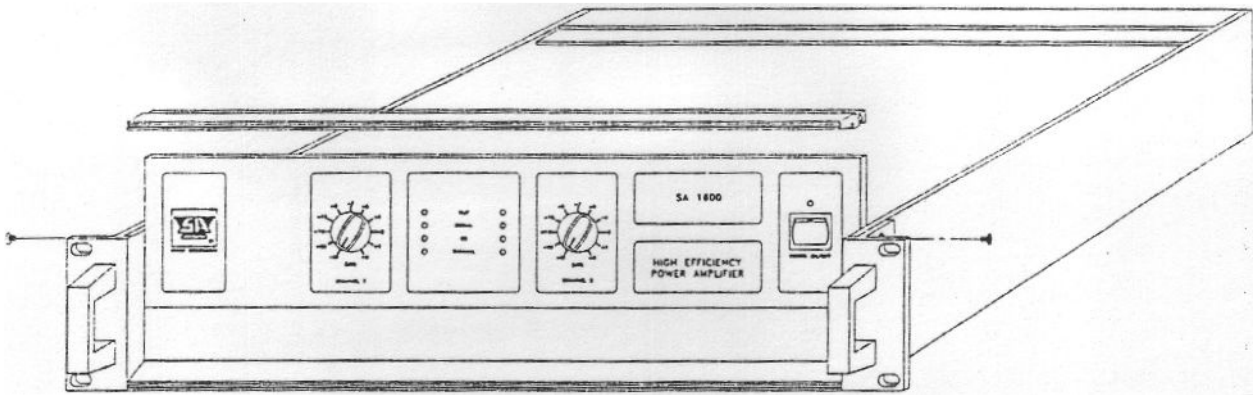
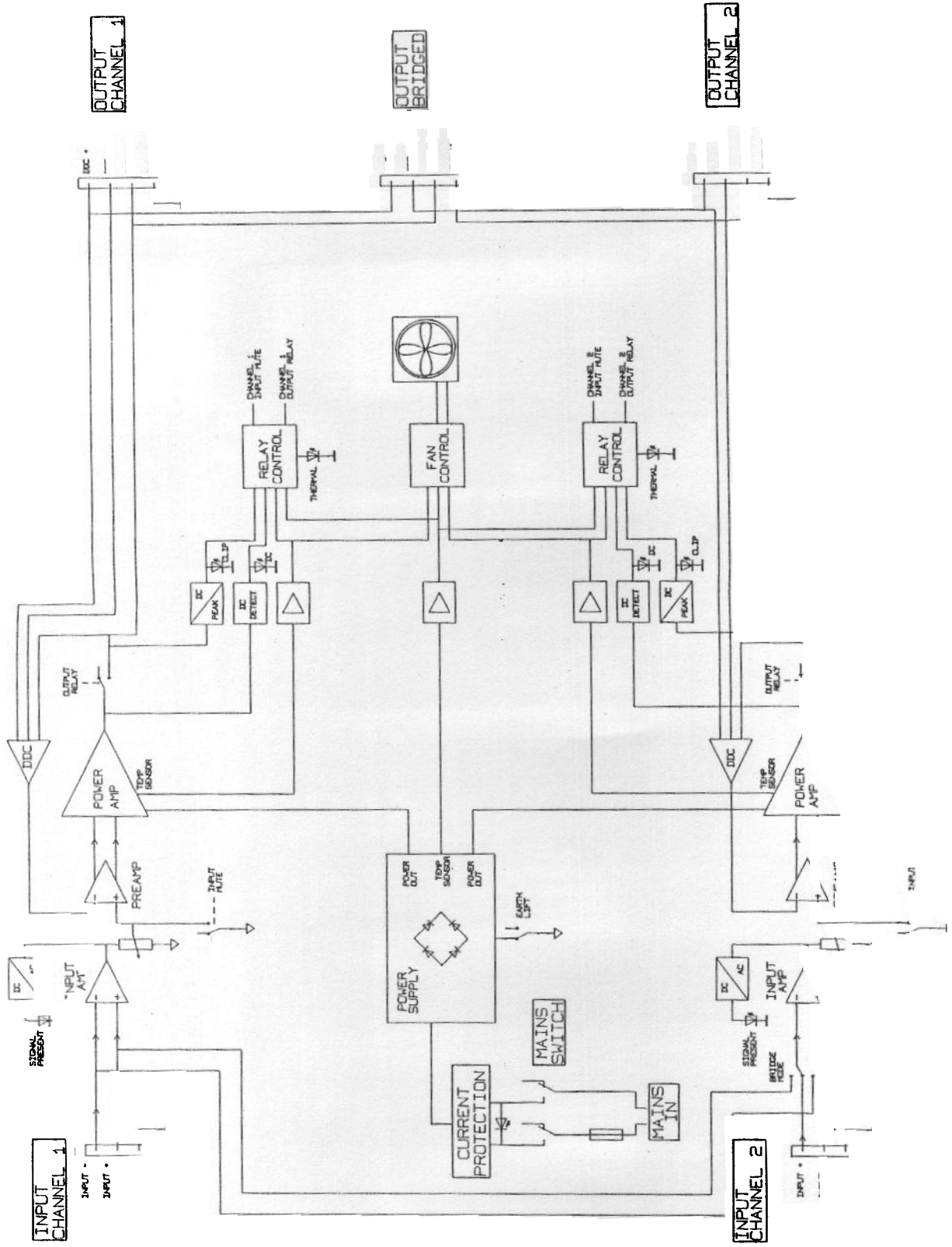
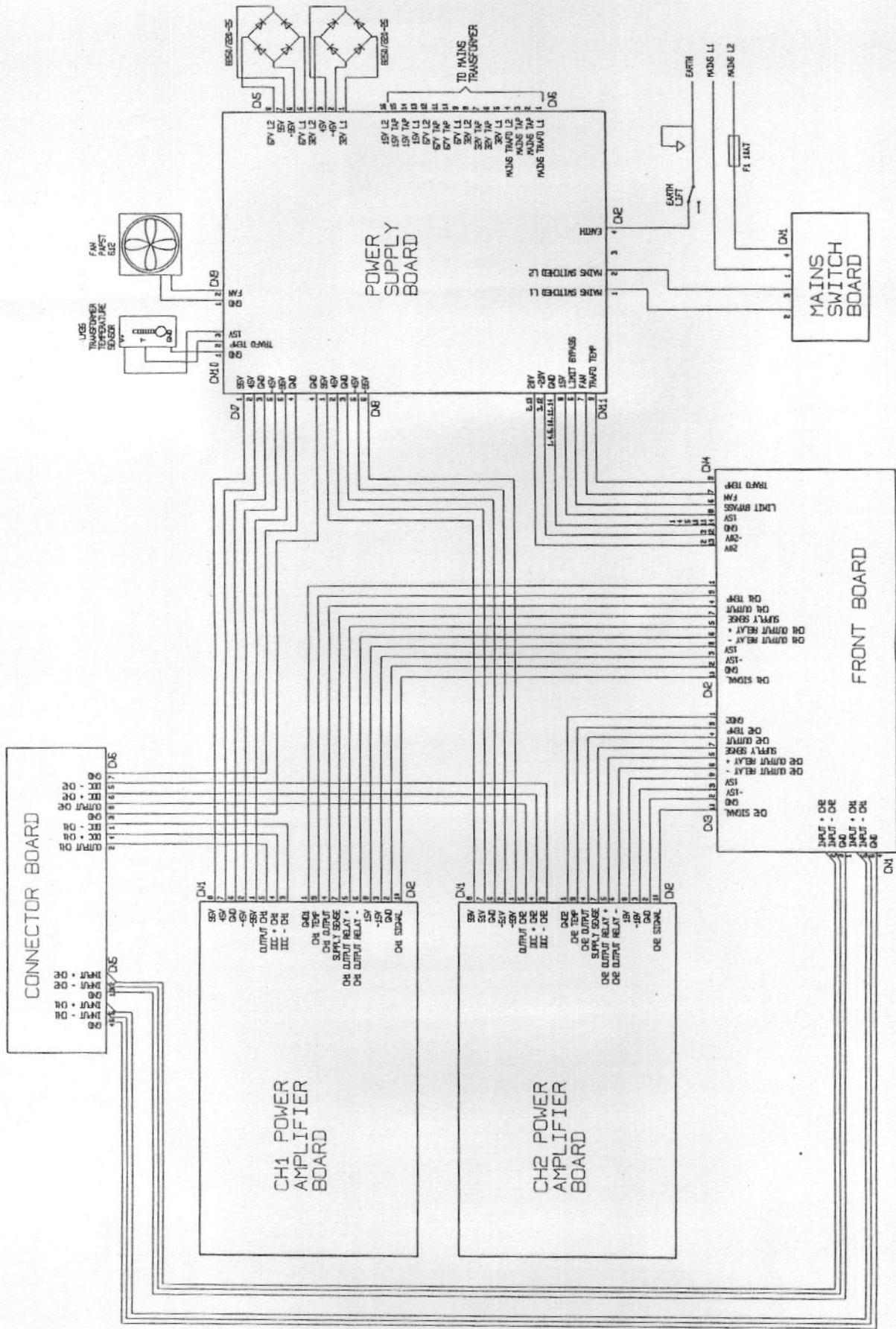

Fig. 2 Removing the front panel

Next you will find two schematic diagrams that explain the operation of the amplifier and the way the several boards are connected.



	PROJECT SA 187/188	HOORN
	CIRCUIT SCHEMATIC DIAGRAM	THE NETHERLANDS
	DRAWING NO. SA187/187	UPDATE FROM:
	DATE: 05-07-88	DRAUGHT: A. KUIJERS
REFURNS		
A3		



5 BASIC OPERATION OF THE ELECTRONICS

This chapter describes some of the key circuits of the SA 1600/800. The complete circuit drawings can be found on page 15 to 26.

5.1 INPUT AND PROTECTION CIRCUITRY

See page 16 for the schematics.

The front board contains the electronics for the input amplifier and the protection circuitry.

The input amplifier is a straightforward opamp differential amplifier.

Low frequency common mode rejection can be trimmed with TR2 and TR4, high frequency CMR with TR1 and TR5. These are the only adjustments to be made in the complete amplifier. See page 27 for the exact adjustment procedure. The input impedance is 20 k Ω for both input legs.

After the debalancing stage, the input signal can be attenuated by conductive plastic potentiometers. The signal is also fed to a network which detects the presence of input signal. A led will light if the input signal exceeds -34 dBu, regardless the setting of the attenuators.

For protection purposes, each input channel can be muted by relays (RL1 and RL2).

The protection circuitry contains:

- Thermal protection
- Fan speed control
- DC protection
- Inrush current protection

The thermal protection senses the temperature of each power amplifier as well as the transformer temperature. IC4-d calculates the appropriate fan speed. IC5-a/b compares the temperatures to the programmed limits and activates the input mute relays if necessary. The power amplifier temperature limit is 85 °C, the transformer limit is 95 °C. After a thermal overload, the temperature must drop ± 5 °C before the input signal is unmuted again. A power amplifier thermal overload only mutes the related channel. A transformer thermal overload mutes both channels.

The DC protection senses the amplifier output for DC and very low

frequency contents. The output relay is muted when more than 3 volts DC (positive or negative) is detected. The circuit also provides delayed turn on of the output relays.

IC10-c controls the mains inrush current limiter. One second after power turn on, the transformer series resistance is bypassed by means of a relay activated by IC10-c.

5.2 POWER SUPPLY CIRCUIT

See page 19 for schematics.

The power supply board contains all the electronics for rectifying and filtering 6 different supply voltages. ± 95 and ± 45 V voltages feed the power amplifiers (± 72 and ± 35 V for the SA 800) and ± 20 V supplies feed the relays and regulators for the ± 15 V supplies.

Inrush current reduction is obtained by R4 and RL1. When the power switch is turned on, RL1 is not active and R4 is in series with the mains transformer. Therefore, maximum inrush current cannot exceed $220/47 = 4.7$ A. After ± 1 second, RL1 is activated and the transformer is connected normally to the mains. TB1 protects R4 in case of failure of RL1.

The SA 1600/800 can internally be set for either 100-120 V or 220-240 V operation. The voltage range is determined by CN3 or CN4 on the supply board and CN12 or CN13 on the mains switch board. The correct jumper settings are:

	<u>100-120 V</u>	<u>220-240 V</u>
CN3	omitted	installed
CN4	installed	omitted
CN12	omitted	installed
CN13	installed	omitted

Note that the ± 20 V voltages are fused by so called "multifuses" (F1 and F2). These devices normally have a very low impedance. In case a current overload occurs (e.g. because of a faulty component), the internal impedance rises to a high value, simulating a "blown" fuse.

When this happens, turn the amplifier off and perform the needed repair. The multifuses reset automatically and do not have to be replaced.

5.3 THE POWER AMPLIFIER BOARD

The power amplifier board contains a preamplifier (driver) and the actual power amplifier. The basic electronics of the poweramp driver are shown in figure 3.

T21 forms a current source together with R50 and Z5. The collector current is ± 10 mA. This source provides drain current for the dual FET T19.

The input of the amplifier is connected to the gate of the left FET, the feedback network to the gate of the right one. In a steady state situation both input and feedback voltages are equal so both the gate-drain voltages are the same.

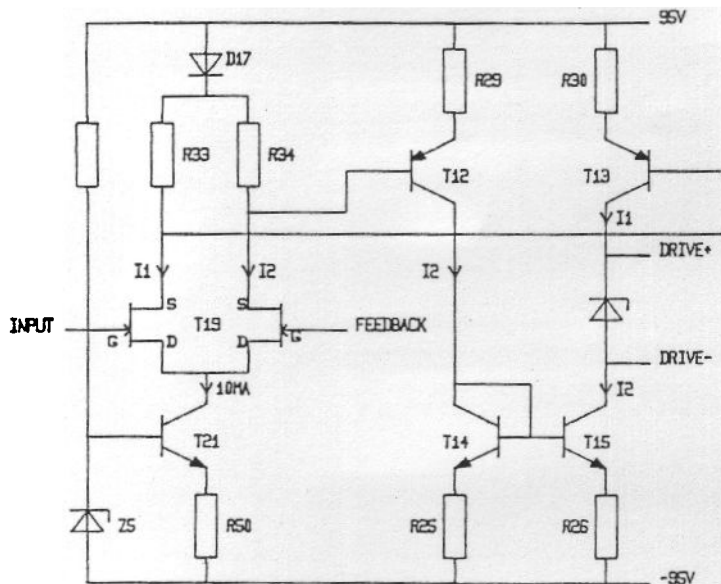

Fig 3 driver circuit

The current of T21 will be equally divided over the two fets, so $I1 = I2 = 5$ mA.

I1 passes a current mirror composed of R33, D17 and T13.

I2 passes two current mirrors, one composed of D17, R34, and T12 and the other of T14 and T15.

In a steady situation $I1 = I2$ so all current pushed out of T13 is pulled into T15 and both the drive currents will be zero.

With a rising input voltage, I1 becomes larger than I2, and not all the current produced by T13 will be pulled into T15. The residual current will be pushed into the power amplifier as drive current (source).

With a negative input voltage, I2 is larger than I1 and drive current will be pulled out of the power amplifier (sink).

DC stability is achieved by the circuit around IC3 (see page 21). To detect DC offset, the power amplifier's output signal is integrated and fed into the feedback loop.

Fig. 4 shows the basic setup of the power amplifier.

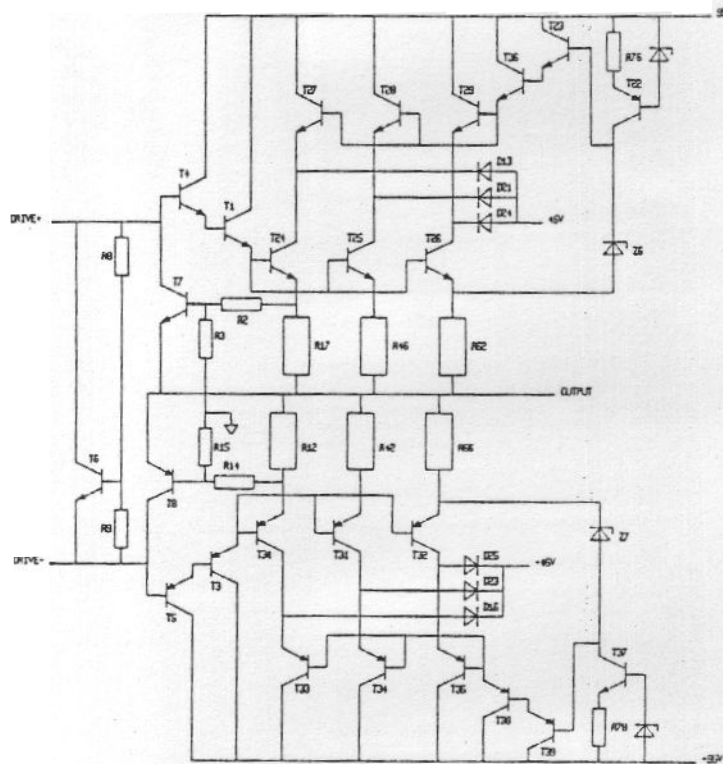

Fig 4 power amplifier setup

The driver circuit provides two signals, drive + and drive -. The positive drive current is boosted by T4 and T1 and fed to the NPN power transistors T24..T26. The negative drive current is boosted by T5 and T3 and fed to T30..T32. T6 is set as a constant voltage source and provides the bias current for the amplifier.

SA 1600/800
SERVICE MANUAL

page: 14
date: 20-08-1990
issue: 1

The amplifier normally works on the ± 45 V power supplies through diodes D13, D21, D24, D16 etc..

Current limiting is handled by T7 and T8. When the current drawn from the amplifier rises, the voltage across R26 and R27 rises too. At the moment this voltage reaches ± 0.65 V, T3 and T4 start conducting and limit the drive current for the power stage. Current limiting depends on the output voltage. At 0 V output the maximum current per transistor is ± 5 A rising to ± 12 A at 50 V.

The circuit around T22 is a current source that provides bias current for Z6. So Z6 is a constant voltage source of 6.2 volts. T23, T36 and T27..T29 form a high current gain amplifier. With T27 to T29 having a constant emitter voltage of 45 V, this current amplifier is biased through T22 when the output voltage is 42 V or more and the collector voltage of T24..T26 will rise linearly with the output voltage. So under 42 V output, the T24..T26 collector voltage is 45 V. Above 42 V, the collector voltage will be $V_{out} + 3$ Volts. Thus the maximum CE voltage of any conducting power transistor does not exceed 45 V, reducing dissipation significantly. Operation for negative output voltages is identical.

Basic functioning of the SA 800 power amplifier is identical. However, voltages and currents are smaller so the SA 800 power amplifier has 4 pairs of output transistors instead of 6.

The complete schematics can be found on page 21 and 22 for the SA 1600 and page 21 and 24 for the SA 800.

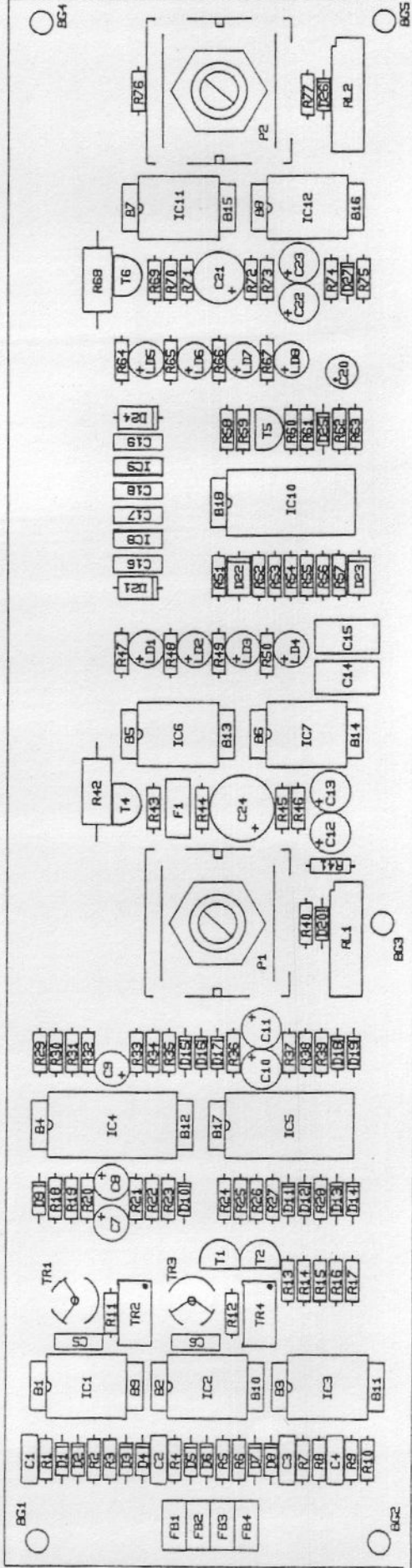
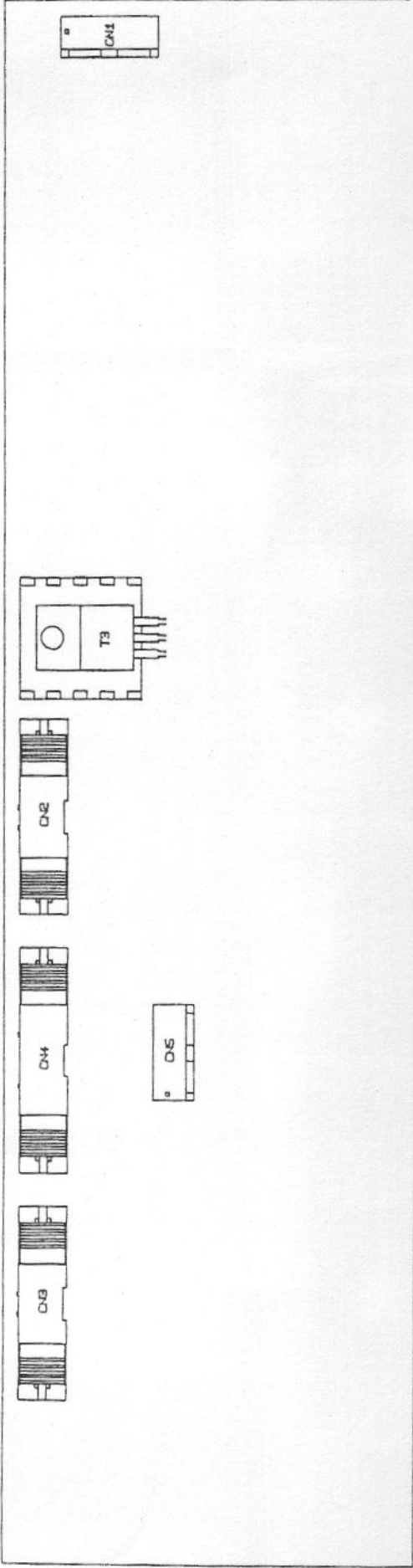

STAGE ACCOMPANY HOORN THE NETHERLANDS

PROJECT: SA 1600/800
 CIRCUIT: FRONT BOARD
 DRAWING NO: SA16/08-9
 PCB NO: 1531.1601/2
 UPDATE FROM: 0 SERIE
 DRAWN: R. RUIPERS
 DATE: 27-07-90

A4

REMARKS:
 COMPONENT LAYOUT



STAGE ACCOMPANY HORN THE NETHERLANDS

PROJECT: SA 1606/800
CIRCUIT: POWER SUPPLY BOARD
DRAWING NO: SA16708-11
FOR NO: 1531.1602/1
REMARKS:
UPDATE FROM: 0 SERIE
DRAWN: R. KUIPERS
DATE: 27-07-90
COMPONENT SIDE COMPONENT LAYOUT

A4

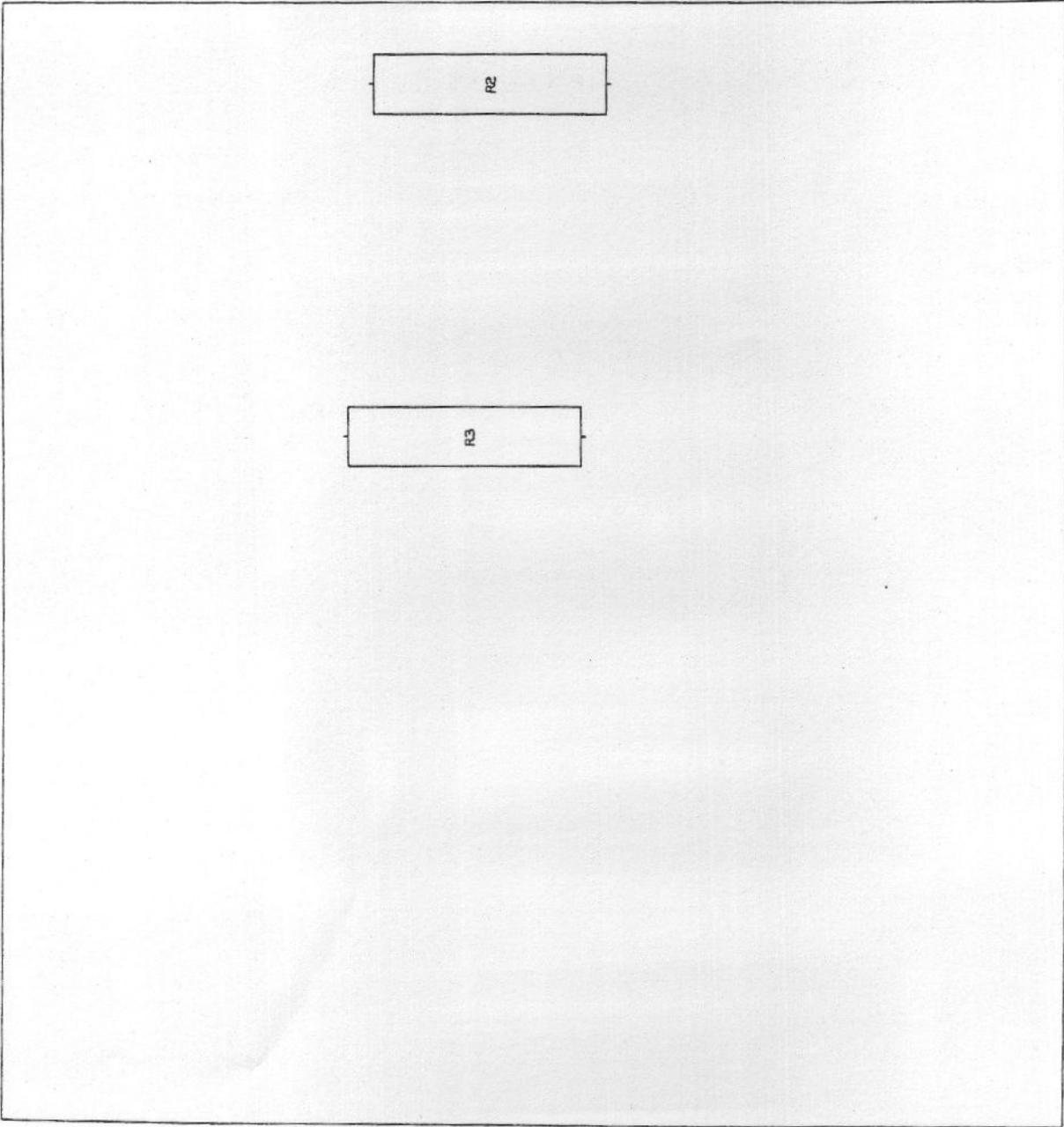

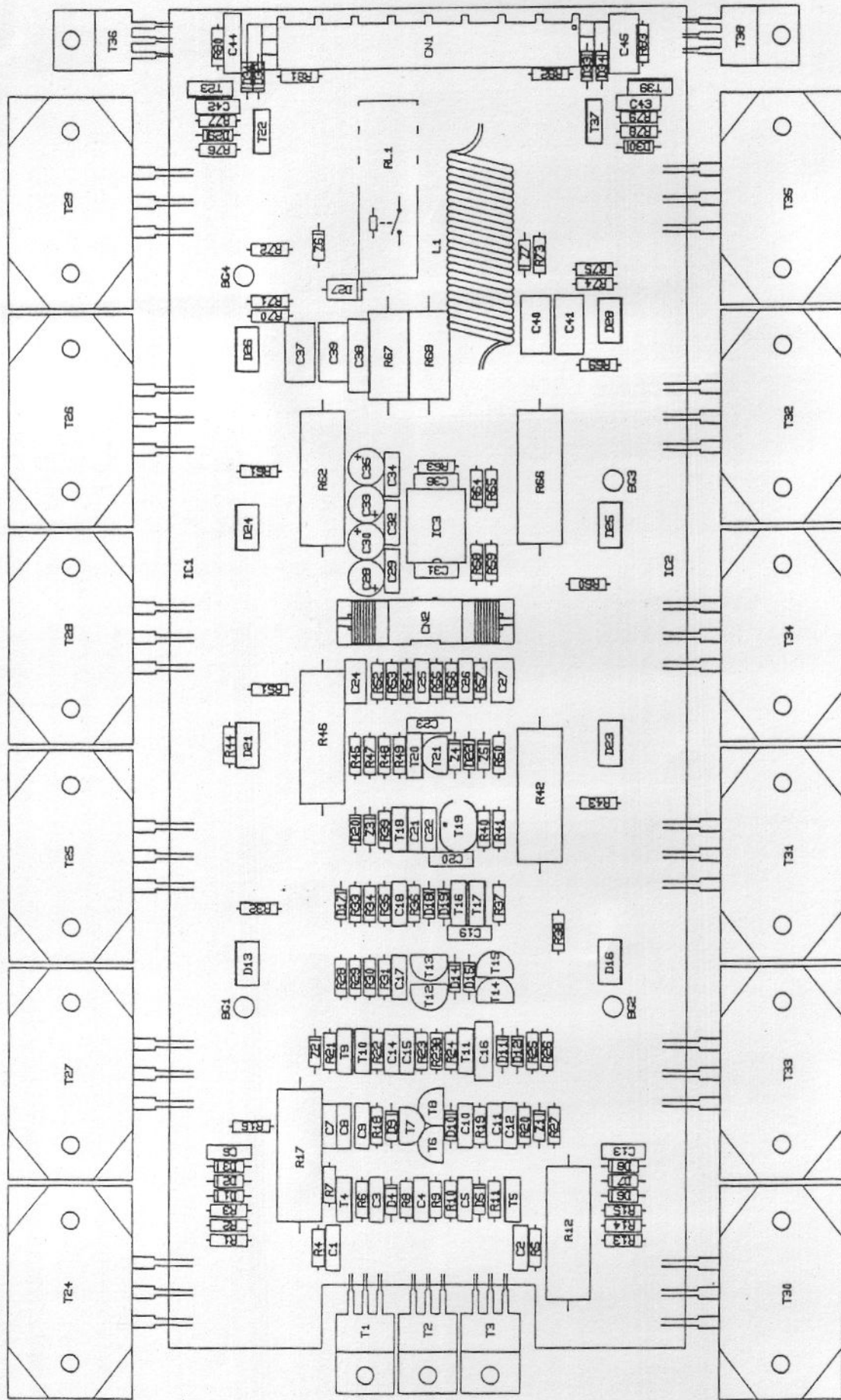

STAGE ACCOMPANY THE NETHERLANDS
 PROJECT: SA 1500
 CIRCUIT: POWER AMPLIFIER BOARD
 DRAWING NO: SA16708-12 UPDATE FROM: 0 SERIE
 PCB NO: 1531.160472 DRAWN: R. KUIPERS
 REMARKS: DATE: 06-11-90

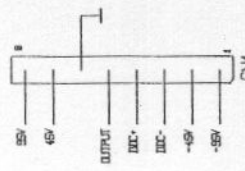
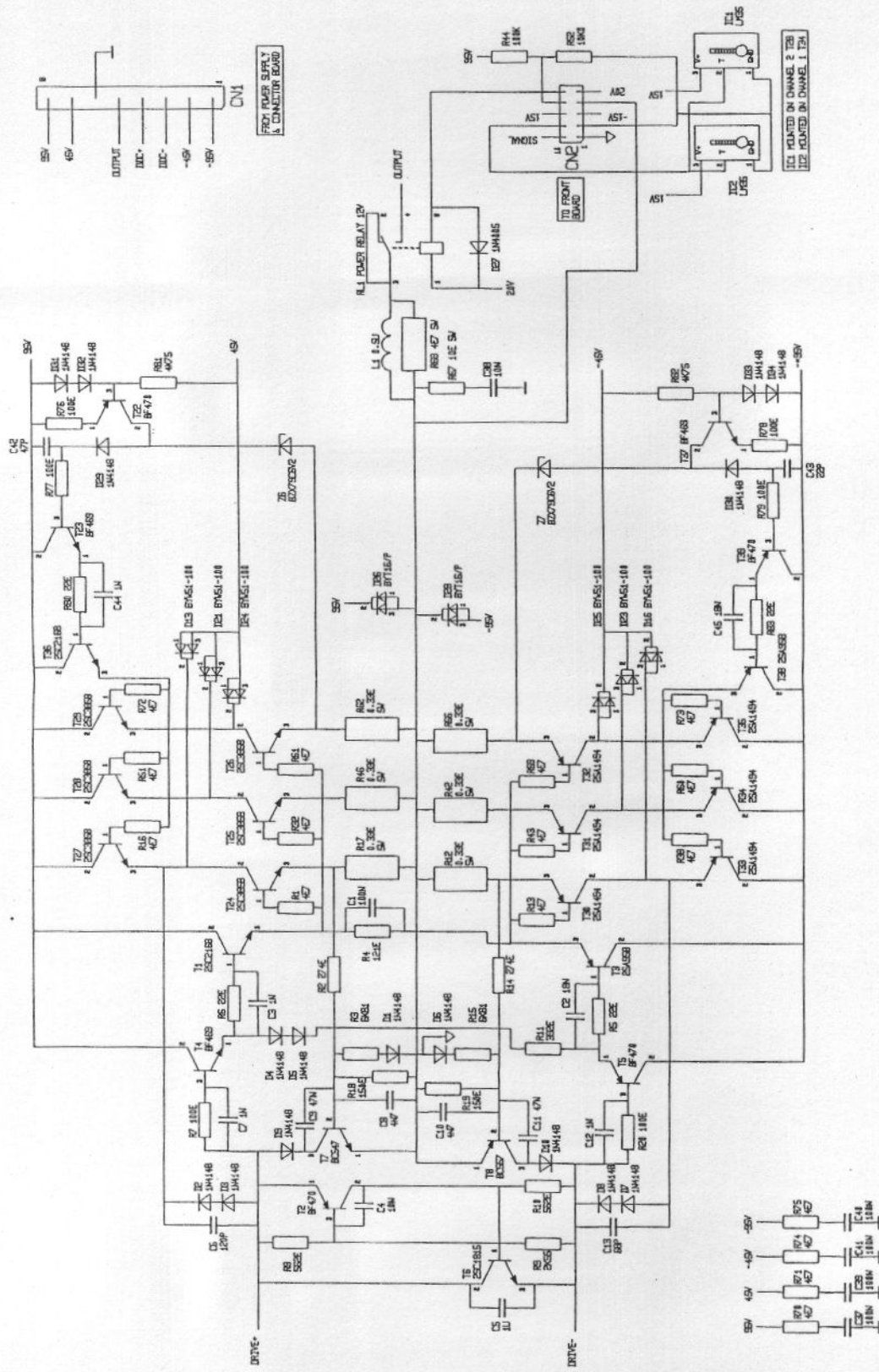

FROM POWER SUPPLY
CONNECTOR BOARD

IC1 MOUNTED ON CHANNEL 2 PCB
IC2 MOUNTED ON CHANNEL 1 PCB

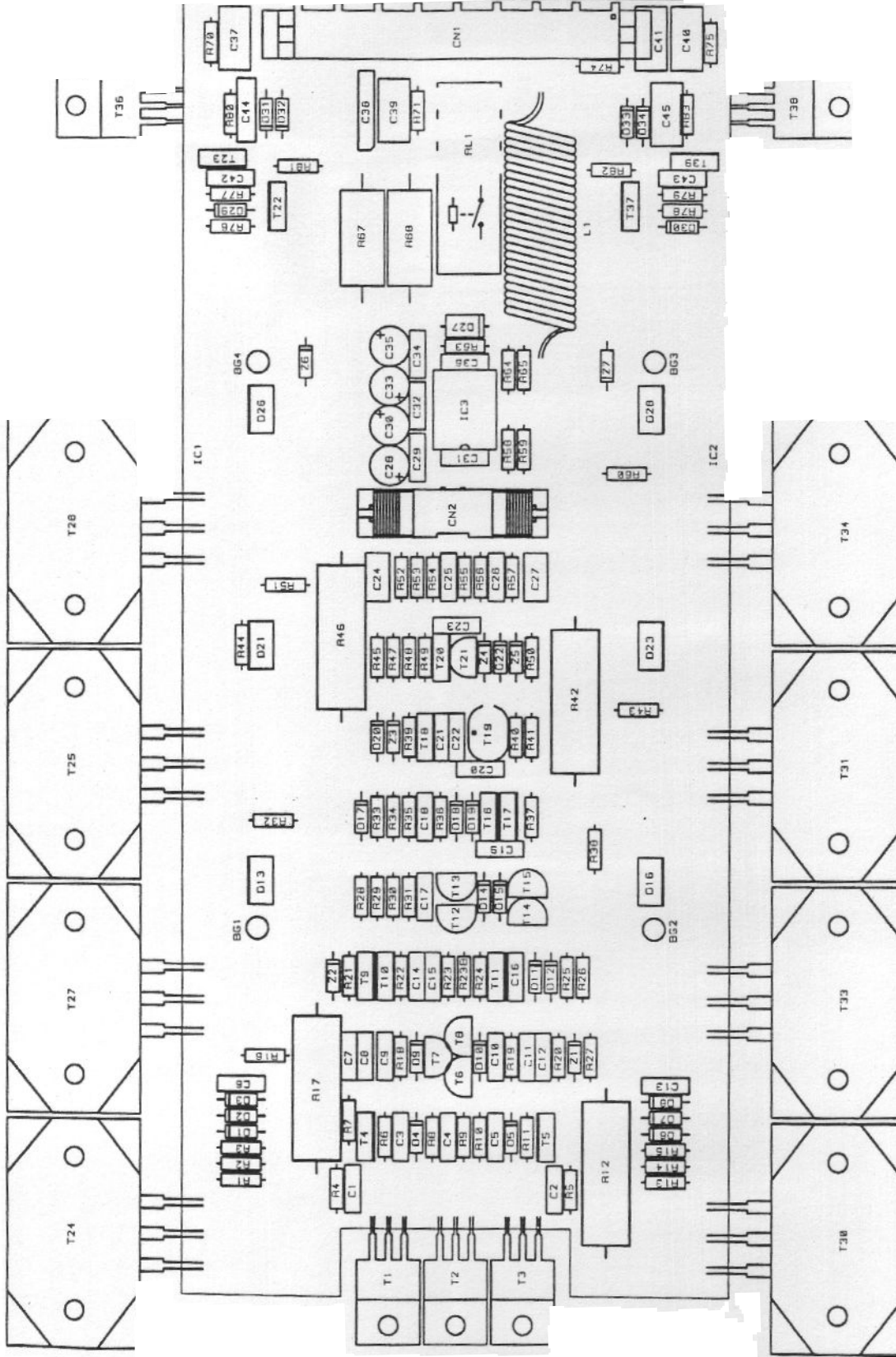

STAGE ACCOMPANY THE NETHERLANDS

A4	PROJECT: SA 800
	CIRCUIT: POWER AMPLIFIER BOARD
	DRAWING NO: SA16/08-13 UPDATE FROM: 0 SERIE
	PCB NO: 1531.1606 DRAWN: R. KUIPERS
REMARKS: DATE: 27-07-90	
COMPONENT LAYOUT	

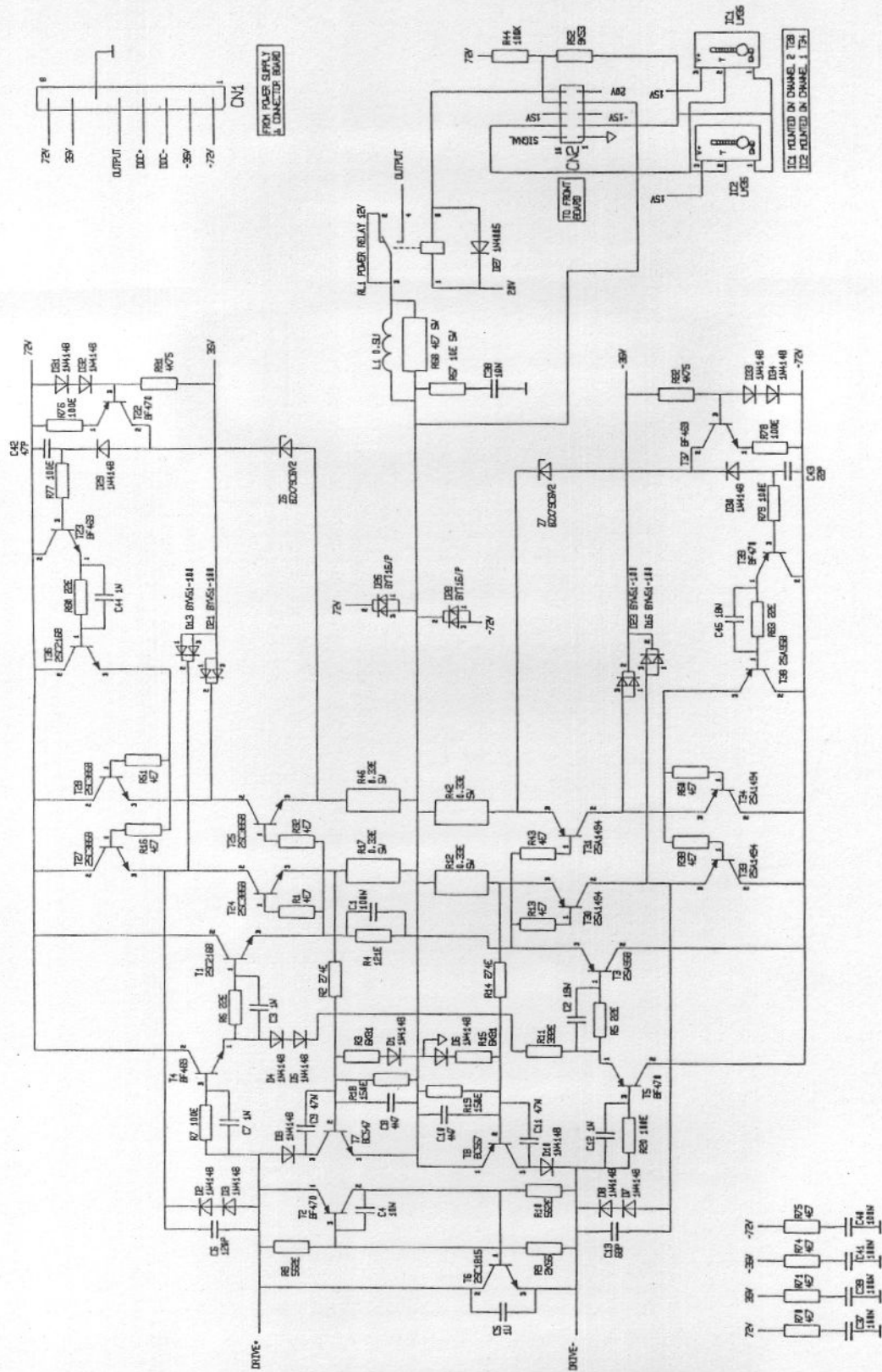

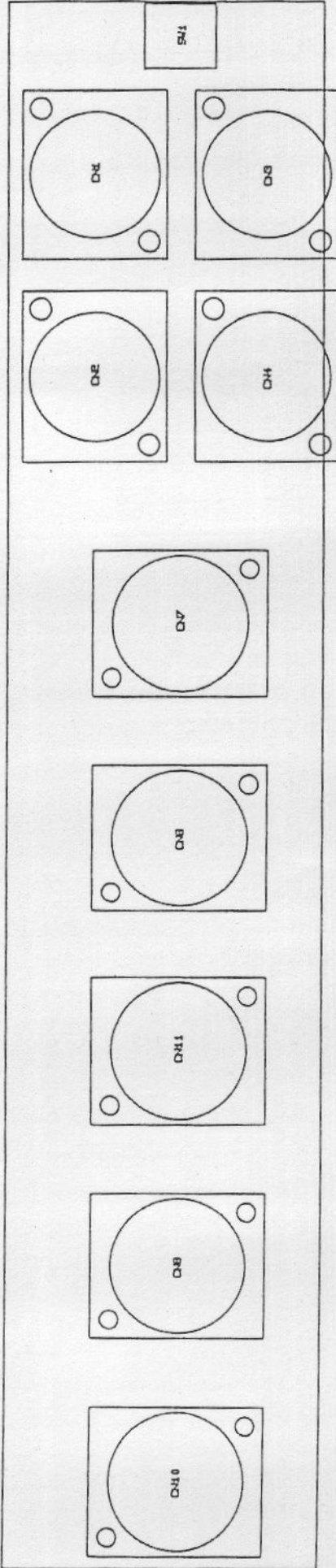
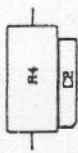
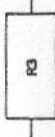
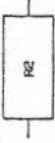
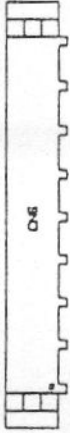
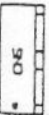

STAGE ACCOMPANY HOORN THE NETHERLANDS

PROJECT: SA 16007800
CIRCUIT: CONNECTOR BOARD
DRAWING NO: SA16708-14
PCB NO: 1531.1605/2
UPDATE FROM: 0 SERIE
DRAWN: R. RIJPEMS
DATE: 27-07-90

A4

REMARKS:
COMPONENT LAYOUT

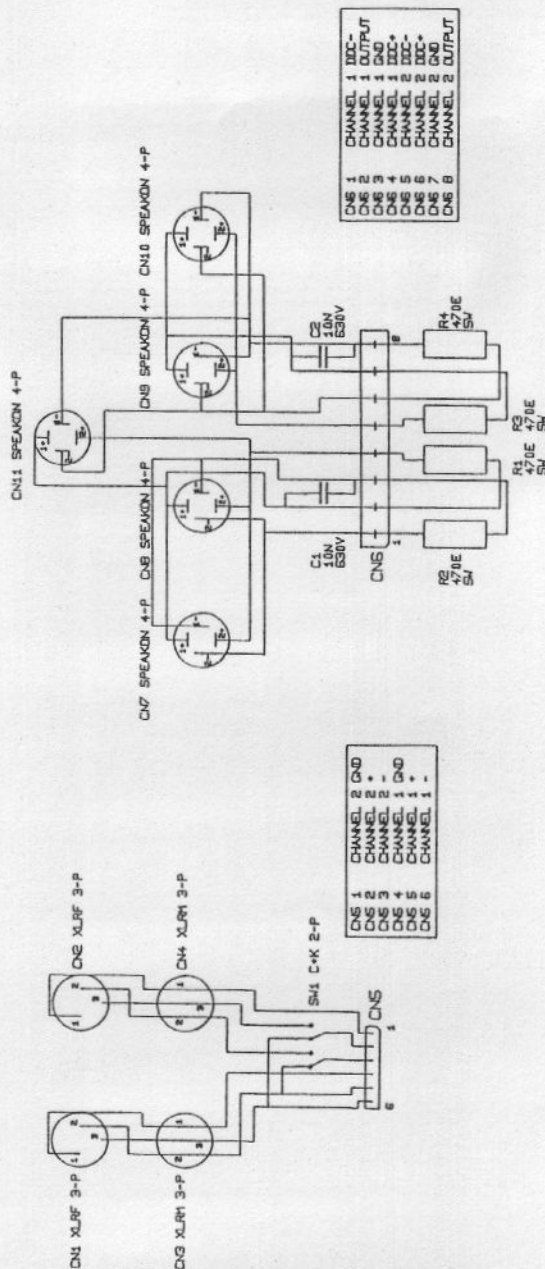

PROJECT: SA 1607801
© CREDIT: INPUT & OUTPUT CONNECTIONS
DRAWING NO: SA1607801-5
DATE: 1991.10.15
DRAWN BY: J. VAN DER WOUDE
REVISION: 1
DATE: 1991.10.15
SCALE: 1:1

7 ADJUSTMENTS

After repair, all adjustable signals should be checked and re-adjusted if necessary.

1 Channel 1 low frequency common mode rejection

input voltage: 0 dBu, 400 Hz sine, attenuator at 0 dB
output load: 8 Ω
adjustment location: TR4 on the front board
instrument: AC volt meter
measure location + : Channel 1 output connector pin 1+
measure location - : Channel 1 output connector pin 1-
value: minimum, typical < 7 mV

*2 Channel 1 high frequency common mode rejection

input voltage: 0 dBu, 20 kHz sine, attenuator at 0 dB
output load: 8 Ω
adjustment location: TR3 on the front board
instrument: AC volt meter
measure location + : Channel 1 output connector pin 1+
measure location - : Channel 1 output connector pin 1-
value: minimum, typical < 16 mV

*3 Channel 2 low frequency common mode rejection

input voltage: 0 dBu, 400 Hz sine, attenuator at 0 dB
output load: 8 Ω
adjustment location: TR2 on the front board
instrument: AC volt meter
measure location + : Channel 2 output connector pin 1+
measure location - : Channel 2 output connector pin 1-
value: minimum, typical < 7 mV

Channel 2 high frequency common mode rejection

input voltage: 0 dBu, 20 kHz sine, attenuator at 0 dB
output load: 8 Ω
adjustment location: TR1 on the front board
instrument: AC volt meter
measure location + : Channel 2 output connector pin 1+
measure location - : Channel 2 output connector pin 1-
value: minimum, typical < 16 mV

For an optimal setting, perform these adjustments twice in the following order: 1 - 2 - 1 - 2 - 3 - 4 - 3 - 4

The bias current of the power amplifier does not need to be adjusted. However, after repair work on the amplifier board, check the bias current of an output transistor pair. The bias current is equal for SA 1600 and SA 800 and must be approximately 100 mA ($\pm 25\%$) each pair.

The bias current can be checked by measuring voltage between the emitters of T24 and T30, T25 and T31 or (for the SA 1600 only) T26 and T32 at a temperature of ± 40 °C. The voltage must be approximately 65 mV.

If the bias current is not within the limits, it can be raised by increasing the value of R9 on the power amplifier board. Similarly, the bias current can be lowered by decreasing R9's value. Do not alter R9 more than 10% of the original value (2K55)! If this is needed, the power amplifier is damaged.

For replacements, only use original power transistors supplied by Stage Accompany. Other types may have poor Hfe or bandwidth specifications.

8 FINAL TEST AFTER SERVICING

For a final test of the amplifier, a signal generator and a level meter/distortion analyser are needed.

First check the maximum output power of the amplifier. Apply an 1 kHz input signal, connect two 8 Ω dummy loads to the output and measure the output voltage. This should at least be 55 V RMS single channel or 52 V RMS both channels driven for the SA 1600. The SA 800 should be able to deliver 40 V RMS single channel and 36 V RMS both channels driven (ref. correct 220 V mains voltage).

Next check the frequency response. This should be done at an output level of 10 V with an 8 Ω load on both the outputs. A typical frequency response is shown in figure 5.

The final result should be better than:

10 Hz \rightarrow 70 kHz -3 dB

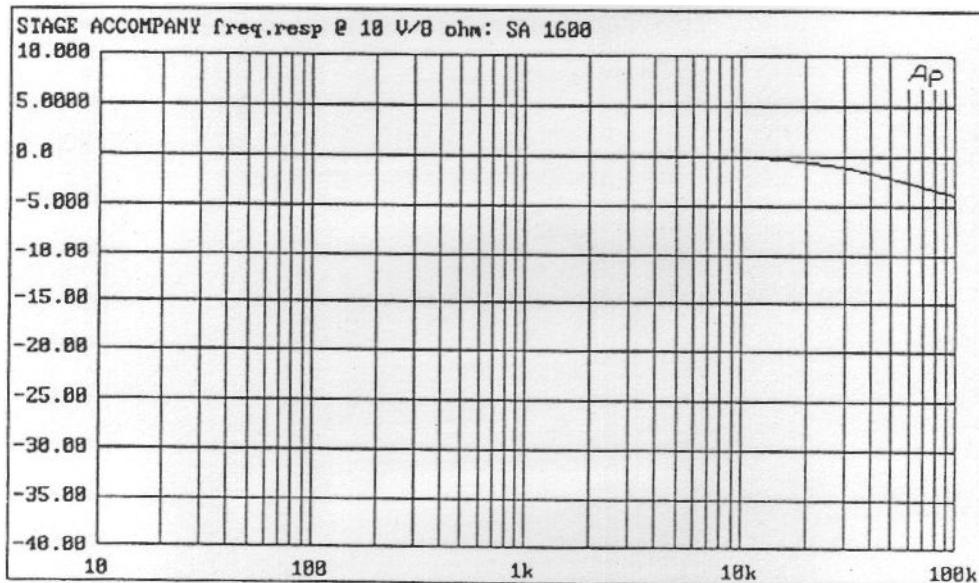

Fig 6 Typical frequency response

Next check harmonic distortion. Final test specs are:

U_{out} = 40 V (SA 800: 30V) into 8 Ω
THD + N 10 Hz \rightarrow 20 kHz ≤ 0.08 %

U_{out} = 40 V (SA 800: 30V) into 4 Ω
THD + N 10 Hz \rightarrow 20 kHz ≤ 0.2 %

Typical distortion graphs are shown in fig. 7. An 80 kHz low pass filter is applied to eliminate unwanted HF products.

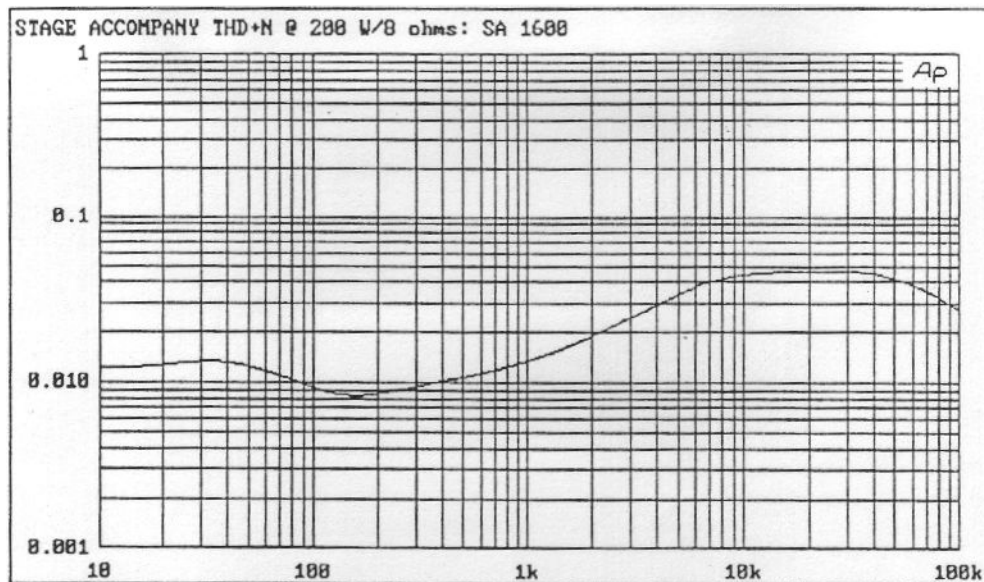

Fig 7 Typical harmonic distortion at 40 V (SA 800: 30V)

The total noise level of the SA 1600/800 should be less than 110 dB under 50 V output level (1 kHz). For this test, a 600 Ω resistor should be placed between pin 2 and pin 3 of the XLR input connector. The best way to test output noise is to measure frequency response without an input signal. A typical graph is shown in fig. 8.

Next test the common mode rejection. A typical performance graph is shown in fig. 12. The norms are:

CMRR: ≥ 70 dB 400 Hz
 ≥ 55 dB 20 kHz

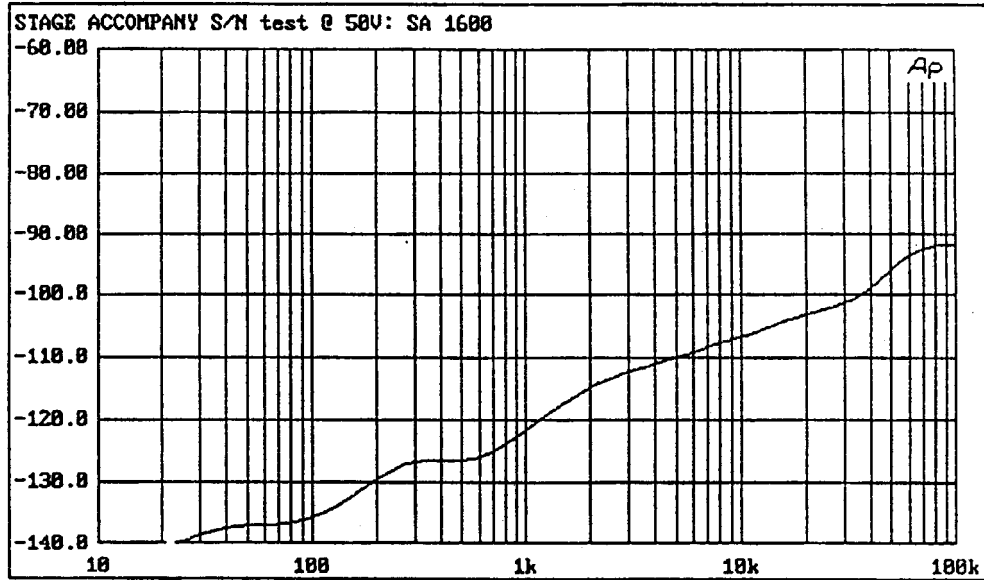

Fig 11 Output noise versus frequency, @ 50 V

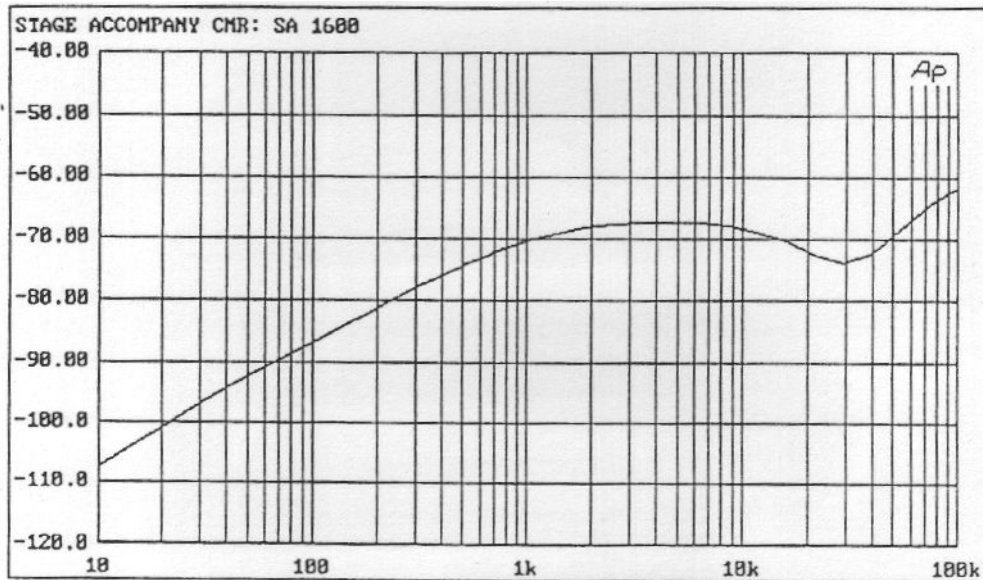

Fig 12 Typical CMR versus frequency

9 SPECIFICATIONS SA 1600 / SA 800

Maximum input level:	+20 dBu (0 dBu = 0.775 V)
Input sensitivity:	+ 6 dBu
Input impedance:	20 k Ω each leg (20 k Ω unbalanced)
Common mode rejection:	> 75 dB, 20 Hz - 20 kHz
Frequency response:	10 Hz - 70 kHz, -3 dB
Gain SA 1600:	28x (29 dB)
SA 800 :	20x (26 dB)
Channel separation:	> 70 dB, 1 kHz, 150 W into 8 Ω > 50 dB, 20 kHz, 150 W into 8 Ω
Total Harmonic distortion: (THD)	< 0.2 %, load impedance \geq 2 Ω , all powers 10% below clipping level. < 0.02 %, 1 kHz, 200 W (SA 800: 100 W) into 8 Ω < 0.05 %, 20 kHz, 200 W (SA 800: 100 W) into 8 Ω < 0.01 %, 1 kHz, 1 W into 8 Ω
Intermodulation distortion: (IMD)	< 0.1 %, 2 kHz - 20 kHz F1 = 70 Hz, 4:1, 200 W (SA 800: 100 W) into 8 Ω
S/N ratio:	>110 dB
Slew rate:	40 V/ μ S
Damping:	>2500, 1 kHz, 10 V into 8 Ω
Continuous output power SA 1600:	2 x 340 W RMS into 8 Ω 2 x 520 W RMS into 4 Ω 2 x 640 W RMS into 2 Ω
Peak output power SA 1600:	2 x 450 W RMS into 8 Ω 2 x 800 W RMS into 4 Ω 2 x 1100 W RMS into 2 Ω
Continuous bridge mode output power SA 1600:	1 x 680 W RMS into 16 Ω 1 x 1040 W RMS into 8 Ω 1 x 1280 W RMS into 4 Ω

SA 1600/800
SERVICE MANUAL

page: 33
date: 20-08-1990
issue: 1

Peak bridge mode output power SA 1600:	1 x 900 W into 16 Ω 1 x 1600 W into 8 Ω 1 x 2200 W into 4 Ω
Continuous output power SA 800:	2 x 160 W RMS into 8 Ω 2 x 230 W RMS into 4 Ω 2 x 300 W RMS into 2 Ω
Peak output power SA 800:	2 x 220 W RMS into 8 Ω 2 x 400 W RMS into 4 Ω 2 x 550 W RMS into 2 Ω
Continuous bridge mode output power SA 800:	1 x 320 W RMS into 16 Ω 1 x 460 W RMS into 8 Ω 1 x 600 W RMS into 4 Ω
Peak bridge mode output power SA 800:	1 x 440 W into 16 Ω 1 x 800 W into 8 Ω 1 x 1100 W into 4 Ω
Power consumption:	100 VA standby 2200 VA max. continuous (SA 800: 1300 VA)
Weight:	17 kg (SA 800: 15 kg)
Housing:	19 inch rack mount 2 U height, 18 inches deep (without connectors)
Dimensions (hxwd):	88 x 482 x 462 mm (without connectors)

SA 1600/800
SERVICE MANUAL

page: 34
date: 20-08-1990
issue: 1

9 LIST OF DRAWINGS

<u>Title:</u>	<u>Drawing no:</u>	<u>Page:</u>
Front board component layout	SA16/08-9	15
Front board schematics	SA16/08-1	16
Power supply board component layout component side	SA16/08-10	17
Power supply board component layout soldering side	SA16/08-11	18
Power supply board schematics	SA16/08-4	19
SA 1600 power amplifier board component layout	SA16/08-12	20
Pre amplifier schematics	SA16/08-2	21
SA 1600 power amplifier board schematics	SA16/08-3	22
SA 800 power amplifier board component layout	SA16/08-13	23
SA 800 power amplifier board schematics	SA16/08-6	24
Connector board component layout	SA16/08-14	25
Connector board schematics	SA16/08-6	26

11 MODIFICATIONS

11.1 POWER SUPPLY

Since the start of production of the SA 800 / SA 1600, 4700uF 100V elcos have come available in the same package as the previous 3300uF 100V elcos.

So in some SA 1600 models, mixtures of 3300 and 4700 uF elcos might be found, with always a minimum of 16000 uF capacitance per 95 volts supply.

All models with serial number 9104160062 or higher use 4 4700 uF elcos per 95 volts supply, leaving the position of C2 and C14 empty to improve air flow through the unit.

In some models of the SA 1600 / SA 800, noise produced by the DC fan appeared on the outputs.

For this reason, a 100 uF 16 V elco is added to the power supply board. It is mounted on the soldering side of the board near CN9 (fan connector). The capacitor is placed across the fan supply voltage. See also figure 13. This update is factory installed from serial number 9012160022.

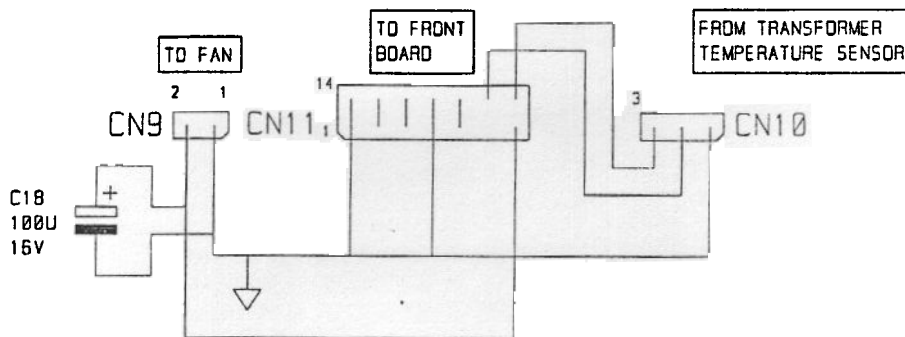

Fig 13. 100 uF / 16 V elco decoupling the fan

11.2 POWER AMPLIFIER

To reduce junction temperature, a clamp on heatsink is installed on driver transistors T10 and T11. This modification is standard on all SA 1600 amplifiers with SN 9104160062 and higher.

For older models, heatsinks can be ordered for at Stage Accompany (no 1331.0932).

This modification is not necessary for SA 800 amplifiers.

12 80 MM FAN UPDATE

12.1 General description

From serial number 207160122, the SA 1600 amplifier features the following changes:

- * The 60mm DC fan at the back of the amplifier is removed and replaced by an 80 mm DC fan at the front. The 80mm fan features an approximately 50% higher airflow than the 60 mm type, while mounting it on the front ensures optimal airflow while rackmounted.
- * The efficiency is optimised by raising the 45 V power supplies to 47 V.
- * The input debalancing opamps are replaced by SSM instrumentation amplifiers, which eliminates 4 adjustments on the front board.
- * The relay inrush current limiter is replaced by NTC surge guards.

Because of these changes, two boards have been redesigned, namely the front board and the power supply board.

12.2 Power supply board

Schematics and component layout of the power supply board are shown on page 37 to 39.

The inrush current limiter with relay and resistor are removed and replaced by two NTC's, placed in series. The worst case inrush current of the SA 1600 while being turned on is now approximately 30 amps.

The connector for the fan has moved to the front board

12.3 Front board

The front board schematics and component layout are shown on pages 40 and 41.

Because of the use of the SSM 2141 input amplifiers, all trimmers have disappeared. So the adjustment procedure of page 27 is no longer relevant for this board.

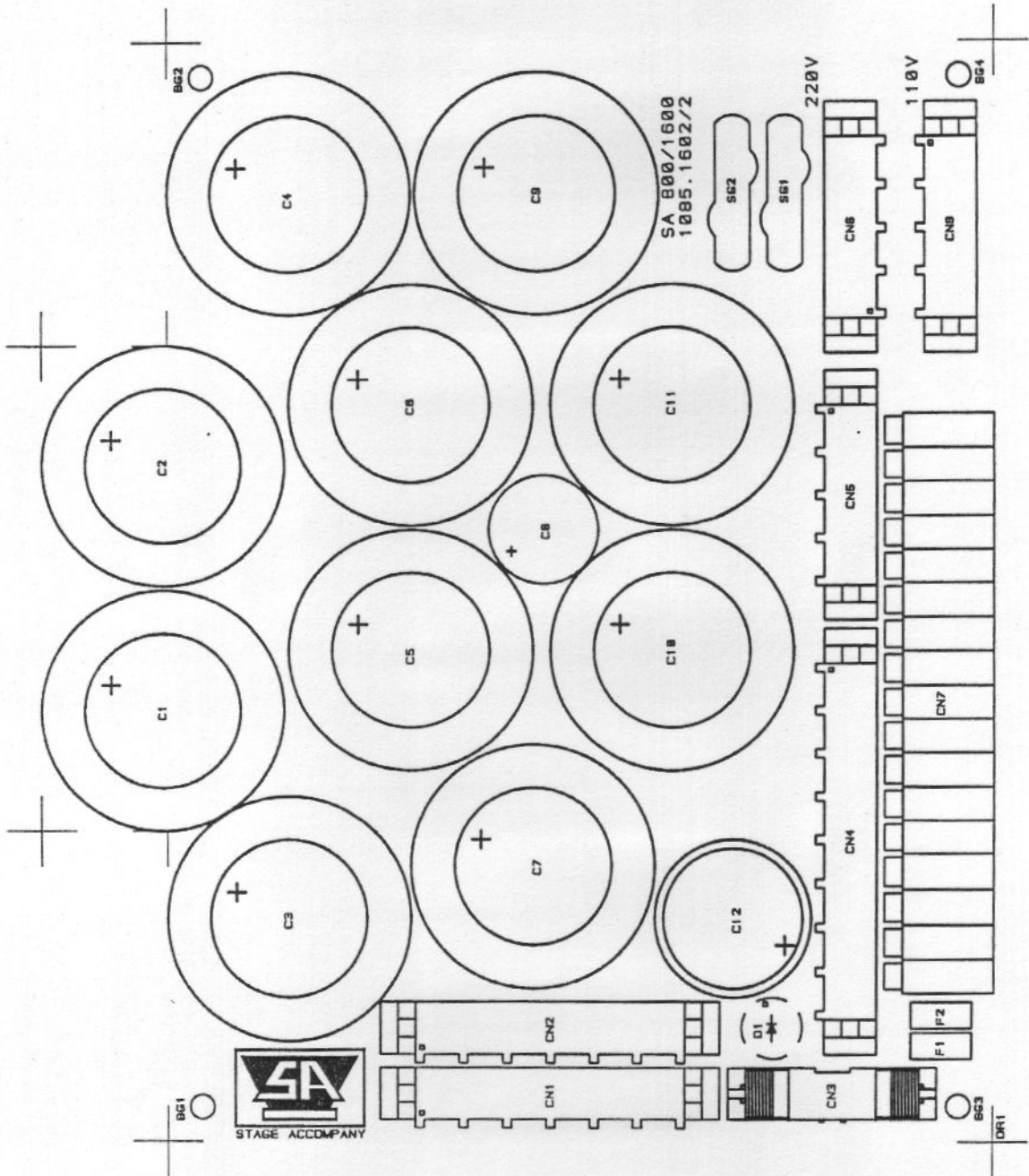

SA 800/1600
1085.1602/2

 A 4	STAGE ACCOMPANY <small>HODORN THE NETHERLANDS</small>	
	PROJECT: SA 1600/800	
	CIRCUIT: POWER SUPPLY	
	DRAWING NO: SA16/00-15	UPDATE FROM: 1085.1602/1
PCB NO: 1085.1602/2	DRAWN: R. KUIPERS	DATE: 13-07-92
REMARKS: COMPONENT SIDE COMPONENT LAYOUT		