

STUDER GC 990 dynamic Software Version 2.6 dyn



Prepared and edited by:
STUDER Professional Audio AG
Technical Documentation
Althardstrasse 30
CH - 8105 Regensdorf - Switzerland

Copyright by STUDER Professional Audio AG
printed in Switzerland
Order no. 10.27.3710 (Ed.0395)

We reserve the right to make alterations.

In this manual the following items will be discussed:

- GC version 2.6 dyn
- Automation Control Unit (ACU)
- Automation modes

For the static part of the program please refer to the operating manual GC Static 2.6.

Contents	Page
1. Scope of Functions	5
1.1 Functions	5
1.2 Definition of Terms	6
2. System Architecture and Configuration	9
2.1 System Architecture	9
2.2 Configurations	9
2.2.1 Tape Recorder	9
2.2.2 Video	10
2.2.3 Motionworker	10
3. System Setup / System Control	11
3.1 Mix Options	11
3.2 Time Code Settings	13
3.2.1 Time Code Reader	14
3.2.2 Time Code Generator	15
3.2.3 Move Clocks	16
4. Automation Page	17
4.1 Description of Functions	17
4.2 Creating a New Mix	25
4.3 Automation of the Small Faders	29
4.3.1 Operating the Small Faders	29
5. Automation Control Unit (ACU)	30
5.1 Introduction	30
5.2 Operation	31
5.2.1 Setting the Automation Modes	31
5.2.1.1 Example for Automation Mode Setting	32
5.2.2 Creating SUBSETs	33
5.2.3 Destination Area Keys SEL, SUB, ALL	34
5.2.3.1 Example with ALL Key active	34
5.2.3.2 Example Channel Selection	34
5.2.4 IN and OUT Keys	35
5.2.4.1 IN and OUT Keys in Conjunction with PUNCH IN/OUT	35
5.2.5 COPY Function	36
5.2.6 TRIM Function	37
5.2.6.1 Example with TRIM	37
5.2.6.2 Example without TRIM	37
5.2.7 GLIDE Function	38
.....	cont.

Contents (continued)	Page
5.3 Automation Modes	39
5.3.1 WRITE ENABLE Mode	39
5.3.2 WRITE Mode	40
5.3.2.1 Examples to WRITE Mode (Motor Faders)	40
5.3.2.2 Examples to WRITE Mode (Manual Faders)	42
5.3.2.3 Examples with Switches in WRITE Mode	44
5.3.3 UPDATE ENABLE Mode	46
5.3.4 UPDATE Mode	47
5.3.4.1 Examples for UPDATE Mode (Motor Faders)	48
5.3.4.2 Examples for UPDATE Mode (Manual Faders)	51
5.3.4.3 Examples with Switches in UPDATE Mode	52
5.3.5 ISOLATE ENABLE Mode	53
5.3.5.1 Examples for ISOLATE ENABLE Mode	54
5.3.5.2 Switches in ISOLATE ENABLE Mode	54
5.3.6 ISOLATE Mode	55
5.3.7 READ Mode	56
6 CUE List and Trigger / Signal Trigger	57
6.1 CUE List and Trigger	57
6.1.1 Setting the Cue Points	57
6.1.2 <i>Cue List and Trigger</i> Page	58
6.1.3 Editing Cue Points	59
6.2 <i>Signal Trigger</i> Page	61
6.2.1 Establishing a Signal Trigger	61
7 OFFLINE Functions	63
7.1 <i>Insert Mix</i>	63
7.2 <i>Move Mix</i>	65
7.3 <i>Fill Mix</i>	66

1 Scope of Functions

1.1 Functions

With this software version the dynamic automation is integrated into the existing static version of the graphical controller 990.

It contains the following functions:

- Version 2.6 dynamic**
- The complete scope of functions of the static version 2.6.
 - Dynamic automation of faders.
 - Dynamic automation of switch functions and input gain setting.
 - Cue points.
 - Signal triggers can be assigned to cue points.
 - Mix passes are stored onto the internal hard disk of the console. Previous mix passes can easily be loaded.
 - There are mix, cue, and trigger lists available.
 - The length of a mix is limited to 6 hours, the number of mixes is only limited by the mixing console's hard disk capacity.
 - The system works with all time code formats (24, 25, 30 drop frame, 30 frames)
 - Off-line functions, as move mix, insert mix, and fill mix.

Main faders, small faders, and VCA master can be automated.

The mix data of up to 80 main faders,
64 small faders,
16 group faders,
8 summing faders,
8 free VCA master faders, and
8 separate VCA master faders
can be processed.

All switch functions of

- Input Units 1.990.210 / 220 / 23x / 24x (including input gain adjustment),
- Group Units 1.990.25x, 26x, 27x, 28x, and
- Summing and Aux Master 1.990.310
can be automated,

except switches on

- Snapshot Unit
- Central Assign Unit
- ACU
- CR Monitor and its source selectors
- Studio Monitor and its source selectors
- PFL / TB / Headphone Panel,

as well as the following switches on the Fader Units:

- PFL keys
- SOLO keys
- Shift keys.

1.2 Definition of Terms

Dynamic Automation

Recording and replaying of fader movements and switch actions against a time axis.

Automation Modes

See also section 5.

For automation of faders and switches the following modes are available:

WRITE MODE Writing (overwriting) of fader/switch data.

The WRITE mode will be completed by the WRITE ENABLE mode (WRT ENA).

This mode is a precondition for the change to the WRT mode. In WRT ENA mode the console or channels are ready to be put into the WRT mode and recording mix data.

In WRT ENA mode no mix data will be written, but existing mix data will be replayed.

For writing fader data it is necessary to switch from WRT ENA mode to WRT mode, that is, the mixing console must be "armed".

The WRT mode is a status of the mixing console in which mix data can be written or overwritten.

UPDATE MODE Writing relative to existing mix data (UPDATE; UPD-Mode).

Similar to WRT mode, the UPD mode is completed by the UPD ENA mode.

Before fader movements relative to existing mix data can be recorded, the mixing console/channel must be switched to UPD ENA mode. In UPD ENA mode no data are written (but existing mix data will be replayed).

The console is now ready to be changed through specific action from UPD ENA mode (console is "armed") to the UPD mode.

When the mixing console is in UPD mode, the fader movements are recorded relative to the existing movements.

ISOLATE MODE The mixing console is decoupled from the mix data (ISOLATE; ISO).

In ISO mode no mix data are replayed. The mixing console behaves as if the automation were disabled.

The so-called ISO ENA mode replays recorded mix data.

In ISO ENA mode no mix data can be written or modified at any time. However, when recorded mix data are replayed, modifications or direct interventions into the replay parameters are possible.

When replaying a mix it is possible to modify the VCA replay values of a channel (e.g. by closing the fader) without influencing the actual mix data.

When the same mix is used the next time, the original mix data are replayed.

READ-MODE Read only (replay) of mix data (READ mode).

This mode applies only to the faders. There is no READ mode for switch data.

In READ mode the fader mix data can no longer be influenced by changing a potentiometer.

The VCA responds only to the automation data.

In conjunction with motor faders the "rubber band" effect should be noted, that is, when a fader knob is held and then let loose, it immediately jumps to the position corresponding to the VCA value.

Online

If the "Graphical Controller" PC software (in the following text referred to as "GC") is set ONLINE, in contrast to OFFLINE, SMPTE time code information is recognized and displayed by the system.

The ONLINE function is mandatory for working with the automation.

Trigger, Signal Trigger

A signal trigger can be, for example, a fader start, red light, or solo-in-place.

These trigger events can be linked to a cue point, and be initiated automatically at the desired moment.

CUE-Punkte

Cue points can be set on the time axis as desired. It is possible to label the cue points with a name.

The cue points can subsequently be used in the system for defining the punch in/out, WRITE zone, etc.

ACU (Automation Control Unit)

With the ACU the various automation modes of the switch and fader automation can be defined.

The ACU can be operated as soon as automation is enabled (DYN ON).

Storing of Mix Passes

Each mix pass is stored on the hard disk of the mixing console.

A mix pass is defined when:

- a) A new mix is created
- b) Additional or modified data have been created.

Caution: When quitting the GC these mix passes are lost. It is assumed that the desired, "good" mix passes have been stored as mix files on the PC hard disk.

The mix currently residing in the mixing console memory can be saved on the PC hard disk by initiating a SAVE function, if necessary under a different name. All desired mix passes can be saved on the PC hard disk in this way (load the mix pass from the list into the mixing console memory).

Mix Start Snapshot

At the beginning of a mix, a mix start snapshot must always be defined. This snapshot can subsequently be modified. The mix start snapshot is called each time the mix start time is counted down. By default the current mixing console setting is loaded as the mix start snapshot, if no other snapshot has been defined.

Mix Start Time

When a new mix is created the start time must be specified, otherwise the currently active time code setting is used automatically as the mix start time. It is not possible to write or replay mix data *before* the mix start time.

TRIM

The TRIM function applies to the (non-motor controlled) manual faders only. So any jumps of the VCA values are avoided when entering one of the active write modes.

GLIDE

When the GLIDE function is active, a defined ramp - from the momentary value to the value valid before - is executed when leaving an active write mode.

2 System Architecture and Configuration

2.1 System Architecture

For operating the 990 automation the following preconditions must be satisfied:

- The ACU (Automation Control Unit) is required for copying/setting fader and switch modes
- The graphical user interface with software version 2.x dynamic
- A time code source for controlling the automation is required, that is, the mixing console is a slave in a system.

2.2 Configurations

2.2.1 Tape Recorder

In this configuration the time code originates from an additional TC track that controls the system.

Studer tape recorders can transmit additional information such as play and stop statuses, or move clocks to the automation system.

In fast wind mode the GC indicates the TC information with the help of the move clocks. This eliminates longer delay times during synchronization, and the criteria that lead to the mix stop, such as STOP or REWIND, are detected immediately.

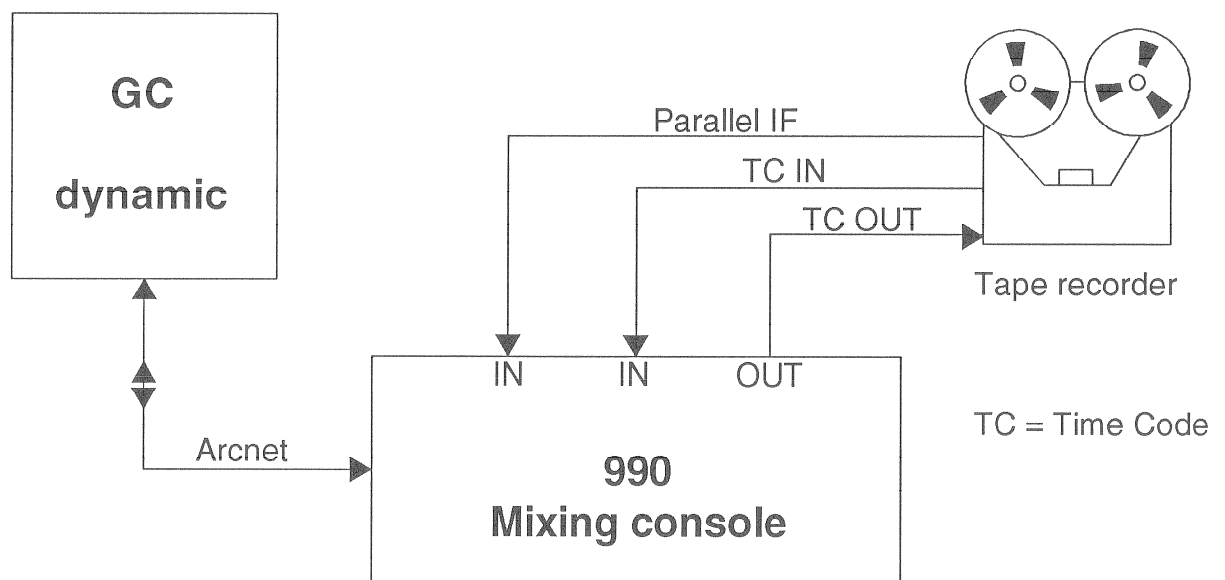

- The TC input/output of the tape recorder and the mixing console are interconnected.
- Tape recorder = master / mixing console = slave
- The automation system detects the incoming TC and will synchronize to it after approx. 2 seconds.

If no TC is received for over one second, the system interprets this condition as a STOP.

2.2.2 Video

If a video machine is the TC master in a system, its time code is used for controlling the mixin console automation.

As a rule the control functions in the same way as with an analog tape recorder.

2.2.3 Motionworker (Studer recorder control)

When the Graphical Controller is used together with Motionworker, additional specific instructions are to be followed - please refer to the corresponding sections in the Motionworker manual.

3 System Setup / System Control

3.1 Mix Options

⇒ via the *Config - Mix Options...* menu.

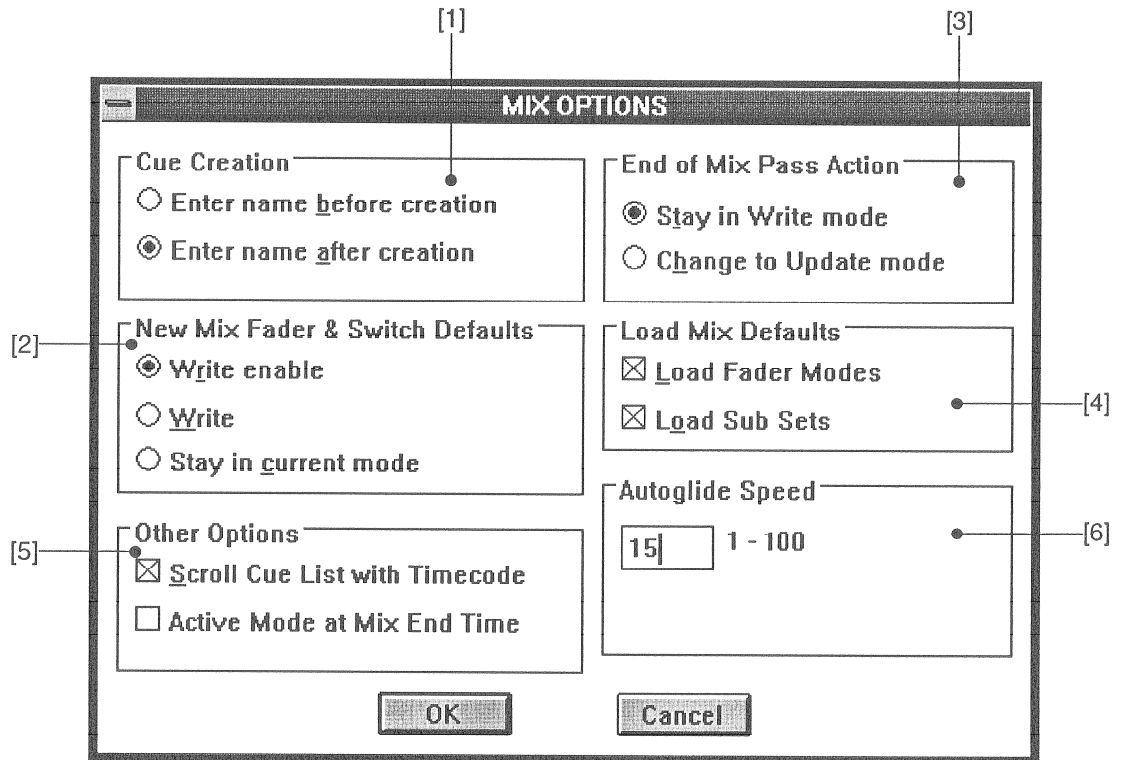

The mix options are stored as user-specific data.

These presets define the following functions:

- [1] **Cue Creation:** Naming of the cue point before or after the cue points are set.
- [2] **New Mix Fader & Switch Defaults:** Default mode of the automation after a new mix has been opened.
- [3] **End of Mix Pass Action:** Automation mode after termination of a mix process (WRITE or UPDATE). Determines whether the mixing console should remain in WRITE mode or switch to UPDATE mode after a mix pass.
- [4] **Load Mix Defaults:** Should the modes of the stored mix also be loaded or should the modes of the current mixing console setting remain as they were. Existing modes and/or subsets already set on the system are overwritten when the corresponding checkboxes are marked.
- [5] **Other Options:** The cue list follows the time code, when the box **Scroll Cue List with Timecode** is checked. When the box **Active Mode at Mix End Time** is checked, all channels being in WRITE ENABLE or UPDATE ENABLE mode change over to active write mode when reaching the mix end. When creating a mix step-by-step, gaps with missing mix data can thus be prevented.

- [6] **Autoglide Speed:** Defines the speed at which the fader position changes when a transition from WRITE (active write) to WRITE ENABLE or from UPDATE to UPDATE ENABLE occurs when the OUT key on the ACU or STAT on the channel is pressed. The function is active when the GLIDE key on the ACU is illuminated. This function is used when an existing mix is partially rewritten and a slow restoration from the momentary value to the existing fader value is desired. This function has no effect when a mix is newly written.

3.2 Time Code Settings

Access via *Pages - Sys Control* menu (Ctrl F3) or SYS function key on the keyboard.
 While saving the titles, TC information is saved as well.

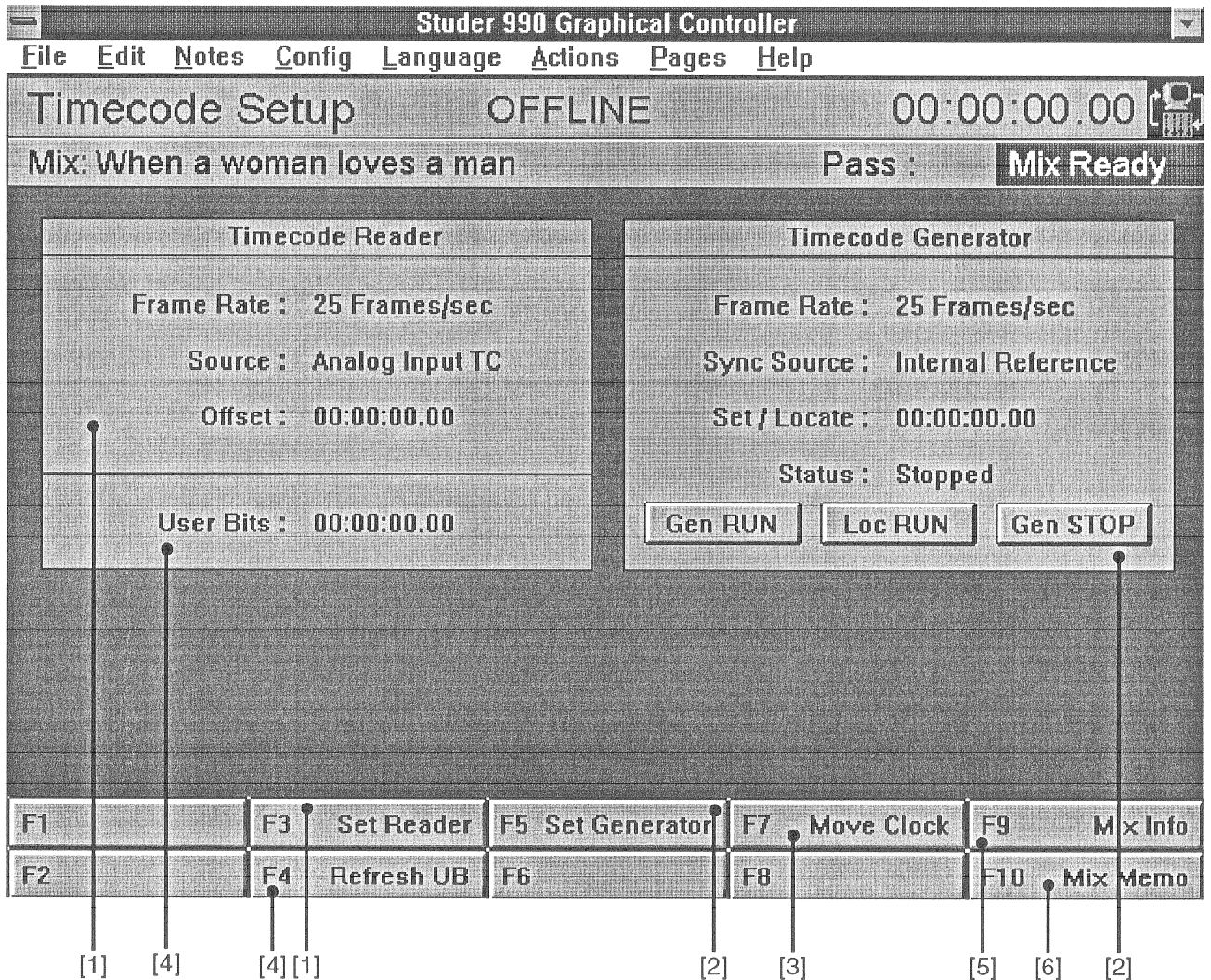

On the *Timecode Setup* page the necessary adjustments for:

- [1] TC reader (F3, *Set Reader*; by clicking to the *Timecode Reader* field, a setup field is opened),
- [2] TC generator (F5, *Set Generator*; by clicking to the *Timecode Generator* field, a setup field is opened), or
- [3] Matching to the move clock of the tape recorder (F7, *Move Clock*) can be made. In addition the following functions are available:
- [4] *Refresh UB* (F4). The supplementary user bit information contained in the time code can be displayed and refreshed as required.
- [5] *Mix Info* (F9). Contains all important information that apply to the current mix in the console.
- [6] *Mix Memo* (F10) opens an input field for attaching notes to the current mix.

3.2.1 Time Code Reader

To ensure correct reading of the time code (TC), the following points must be adapted in the system:

Select **Pages - Sys Control** menu and then press either **Set Reader** (F3) or click on the **Timecode Reader** field with the mouse.

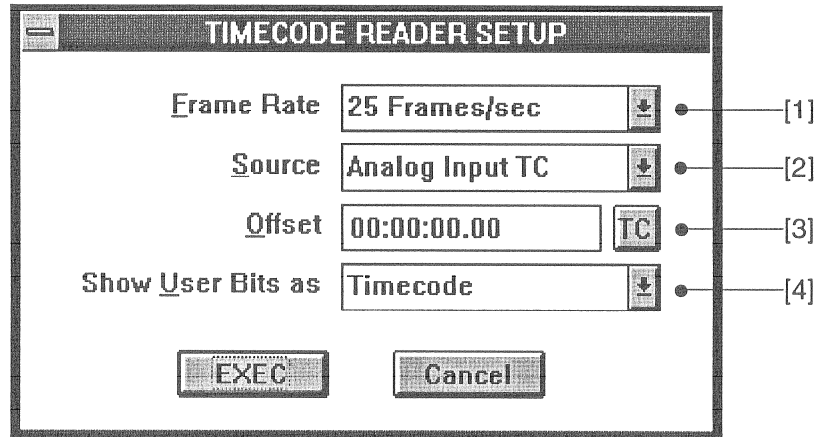

The following parameters can be set:

- [1] **Frame Rate**
 - ⇒ 24 Frames / s
 - ⇒ 25 Frames / s
 - ⇒ 30 Frames / s
 - ⇒ 30 Drop Frames / s

- [2] **Source**
 - ⇒ TC analog input (e.g. SMPTE from tape)
 - ⇒ UB analog input (time code as user bit)
 - ⇒ Time code generator (TC generator integrated in mixing console)

- [3] **Offset**
 - ⇒ opens an input field for editing a time code offset (with respect to either the external or the internally generated time code)

- [4] **Show User Bits as**
 - ⇒ Time code
 - ⇒ Text
 - ⇒ Hexadecimal value

3.2.2 TC Generator

With the built-in time code generator, erased (with bulk eraser) or blank multitrack tapes can be formatted with time code.

It can also be used for rehearsals or for short dynamic sequences that are replayed by starting the generator.

The generator can also be used for setting scenes according to a cue list and playing each of them for a short time in order to write fader data.

For this application the time code generator must be selected as the source of the time code reader.

⇒ TC-IN / TC-OUT are terminated on 9-pin D-type connectors, see pinout in the wiring lists.

The time code level corresponds to the line level of the mixing console.

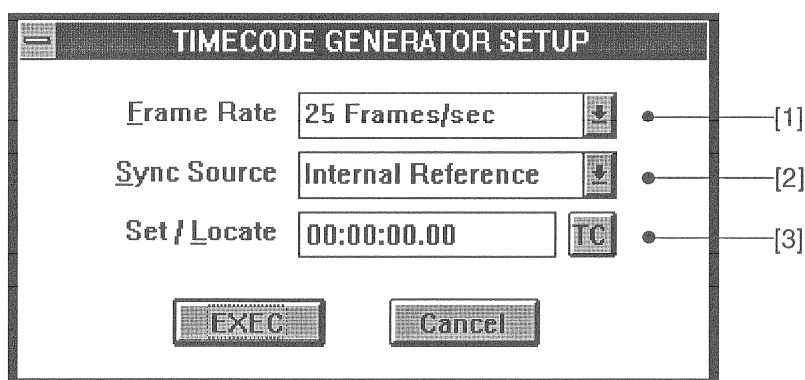

The following parameters can be set:

- [1] **Frame Rate**
 - ⇒ 24 Frames / s
 - ⇒ 25 Frames / s
 - ⇒ 30 Frames / s
 - ⇒ 30 Drop Frames / s
- [2] **Sync Source**
 - ⇒ Internal reference
 - ⇒ Video
 - ⇒ External reference
- [3] **Set / Locate**
 - ⇒ opens an input field for editing the time code.

The time code generator is controlled via the three command buttons **Gen RUN**, **Loc RUN**, and **Gen STOP**.

With **Loc RUN** the generator starts to generate time code values beginning with the specified position [3]; for example, from position 00:00:00:00 .

It can be interrupted with **Gen STOP**. The stopped time code value remains on the display (e.g. 00:01:32:00). When **Loc RUN** is reactivated, the generator restarts at 00:00:00:00:00 .

The **Gen RUN** command button starts the generator at the currently displayed time code address. If the stop occurred, e.g., at 00:01:32:00, **Gen RUN** restarts the generator at this position.

3.2.3 Move Clocks

On the *Timecode Setup* page, you can open the **MOVE CLOCK RESOLUTION** input field by pressing F7 or by clicking on the **Move Clock** command box in the menu bar at the bottom of the screen. The corresponding move clock rate can be set based on the choices in the list. With the aid of the move clock the system can calculate the actual time code position also in high-speed spooling mode without tape head contact, which accelerates the positioning through the automation system.

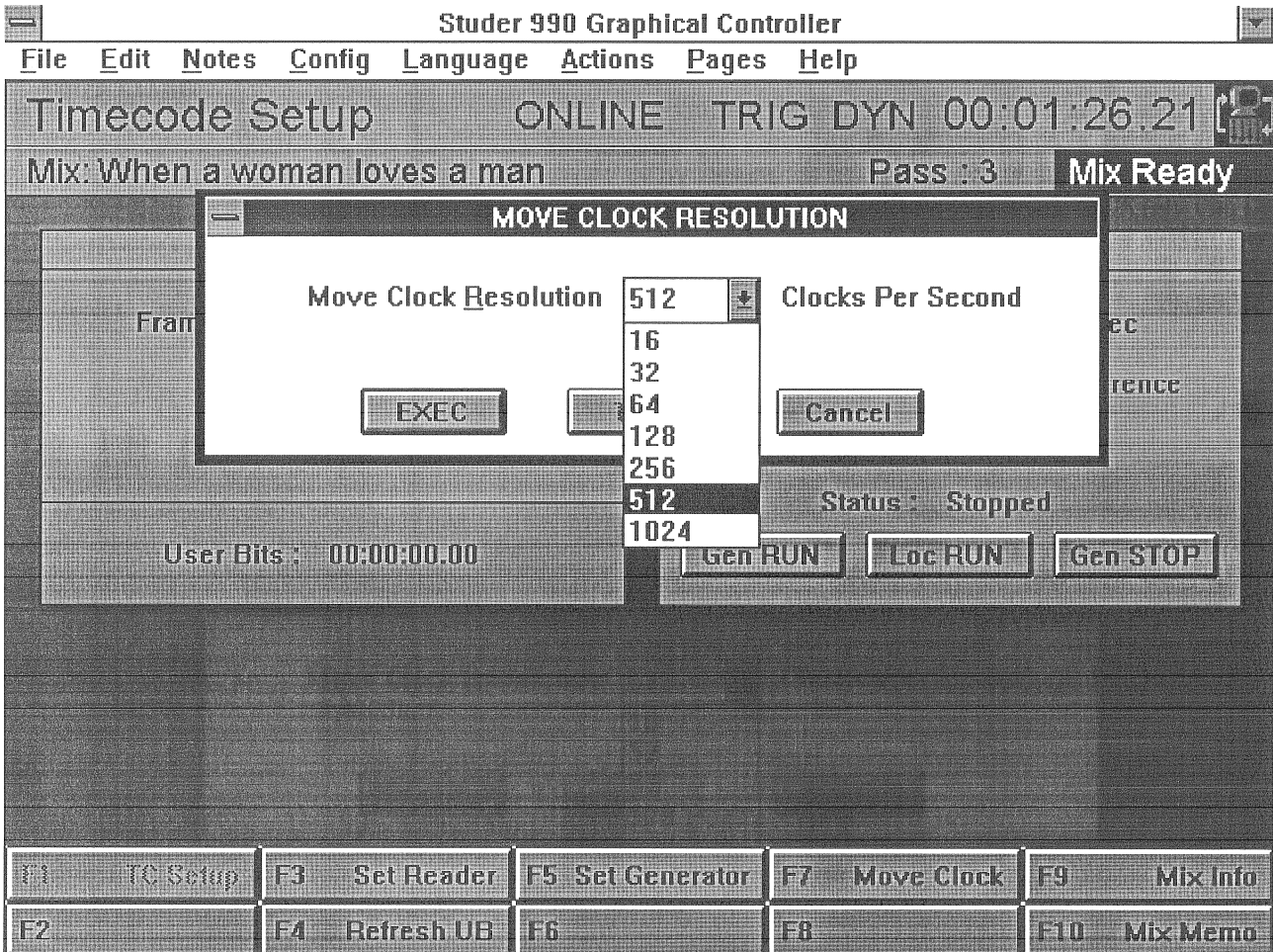

Studer tape recorder:	Tape speed:			
	7.5 ips	15 ips	30 ips	
A-807	64 Hz	128 Hz	256 Hz	
A-810	64 Hz	128 Hz	256 Hz	
A-812	64 Hz	128 Hz	256 Hz	
A-820	256 Hz	512 Hz	1024 Hz	
A-820 MCH	16/256 Hz	32/512 Hz	64/1024 Hz	(selectable)
A-827 MCH	16/256 Hz	32/512 Hz	64/1024 Hz	(selectable)
D-820 MCH	-	-	64/1024 Hz	@ 48 kHz (sel.)
	-	-	58.8/940.8 Hz	@ 41.1 kHz (sel.)
D-827 MCH	-	-	64/1024 Hz	@ 48 kHz (sel.)
	-	-	58.8/940.8 Hz	@ 41.1 kHz (sel.)

4 Automation Mode Page

4.1 Description of functions

A new mix is set up by switching to the **Automation Mode** page.

Switching to Automation Mode page:

- Keyboard: Press the DYN AUTO function key
- Menu: **Pages - Dyn Auto** (Ctrl F6)
- Enable automation via the DYN ON/OFF function key.

Switching the Automation on/off:

- Keyboard: with DYN ON/OFF function key
- Menu: **Actions - Dyn On** or **Actions - Dyn Off** (Shift F3)

When the **Dyn On** function is called from a different page, the **Automation Mode** page is automatically called up and automation is switched on.

The **Automation Control Unit (ACU)** will only be active when automation has been switched on (DYN ON) via the GC.

Switching to the **Automation Mode** page does not suffice for activating the ACU.

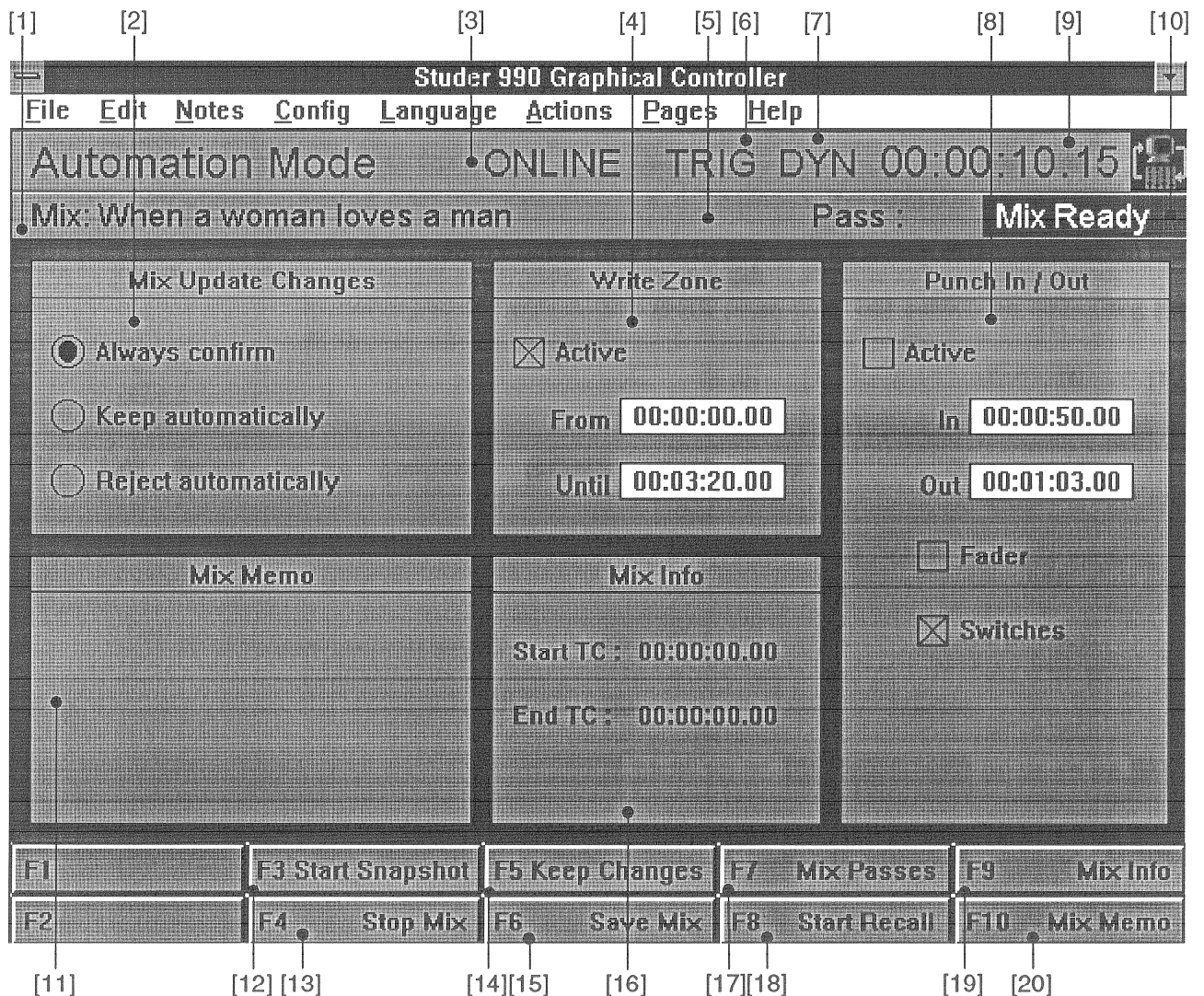

- [1] **Mix**; Mix title; entered when the mix is set up. Can be modified when a mix pass is stored.
- [2] **Mix Update Changes**; here you can select whether the mix pass is to be stored automatically or first to be confirmed.

Every mix pass is first stored on the hard disk integrated in the mixing console (not to be confused with the hard disk of the PC on which the program runs).

The mix passes stored on the hard disk in the mixing console are entered in the **Mix Passes** list (F7).

The current mix pass can be saved on the hard disk of the PC with

- Save Mix** (F6)
- or by choosing the menu option **File - Save** (context-dependent).

When the title is closed, the system asks whether or not the current mix is to be saved on the PC hard disk.

- Always confirm**
- After a mix pass a dialog box **KEEP CHANGES** is displayed.
 - Here the pass can be stored on the desk-internal hard disk with **EXEC**, or be rejected with **Cancel**.

A mix pass is regarded as completed when

- The tape recorder is stopped (= no TC stop)
- Function switch **Stop Mix** (F4) is clicked on.

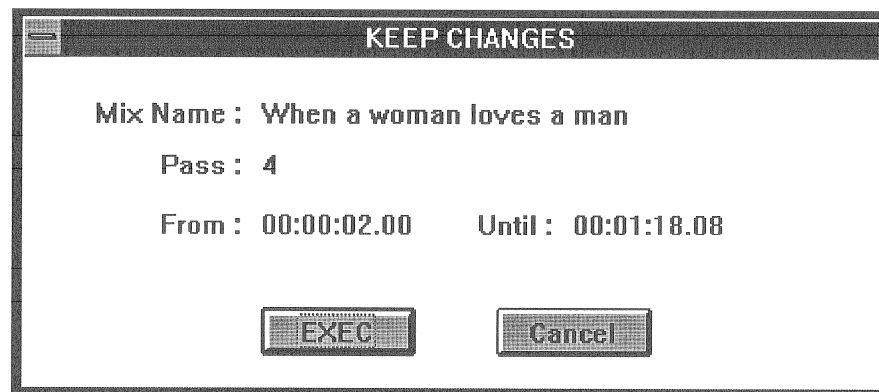

- Keep automatically**
- The created mix pass is automatically stored on the hard disk of the mixing console and is entered in the **Mix Passes** list (F7).

- Reject automatically**
- The mix pass is rejected (rehearse mode).
 - Nevertheless a so-called "scratch file" is stored. It may take several seconds before the system returns to the ready state.
 - With the **Keep Changes** function (F5) it is possible to save a successful pass.

- [3] **ONLINE**; this indicates that the system is ready to receive time code information. Alternative: **OFFLINE**.

The **ONLINE/OFFLINE** changeover is performed either via the keyboard with the **ONLINE** function key or by choosing one of the menu options **Actions - On Line** or **Actions - Off Line** (Shift F1).

- [4] **Write Zone**; a certain time window *From...Until* can be defined here in which the writing of mix data (WRITE / UPDATE) is possible.

When *From* or *Until* is clicked on, an input field is opened in which the desired times can be entered or edited. Existing cue points can be used.

Example: For a song that has already been mixed down to the end, the first verse is to be mixed down again. The rest of the mixdown must remain unchanged.

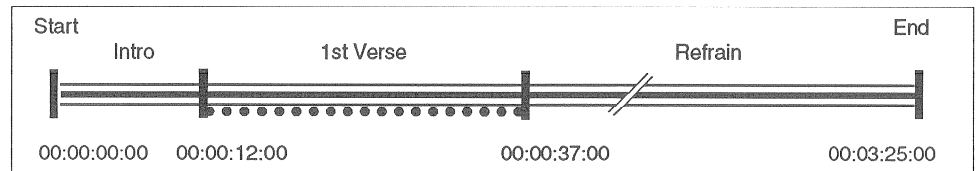

In the above case the **Write Zone** would be defined as follows:

Active Write zone enabled

From 00:00:12:00 Moment at which writing is allowed. Before this moment it is not possible to switch to WRITE or UPDATE.

Until 00:00:37:00 At this moment the system automatically terminates the WRITE or UPDATE mode. It is no longer possible, too, to switch to the WRITE or UPDATE mode.

- [5] **Pass**; All mix passes are numbered and the current mix pass is displayed (in our example: No. 3).
- [6] **TRIG**; signal triggers linked to the time code are initiated. If nothing is displayed the function is not active.
Function call via the TRIG ON/OFF key on the keyboard, or by choosing the menu option **Actions - Triggers On** or **Actions - Triggers Off** (Shift F2).
- [7] **DYN**; Automation is active.
Function call via DYN ON key on the keyboard, or by choosing the menu option **Actions - Dyn On** (Shift F3).
- [8] **Punch In / Out**; for faders and/or switches an automatic punch-in to WRITE or UPDATE can be implemented in a previously defined time window, similar to the procedure known from tape recorders or sequencers.
It is recommended to define the **Write Zone** in such a way that unintentional writing after the punch-out (for example by touching a motor fader button) is prevented.

When clicking on the time display *In* or *Out*, an input field is displayed, and the desired *In* or *Out* markers can be entered.

Time values of existing cue points can be used (see also 5.2.4).

Example with switches: In this example a noise in the pause of a guitar solo is to be muted with *Punch In / Out*.
The function is very useful in this case, because the pause is very short, and it would be difficult to make the correction manually.

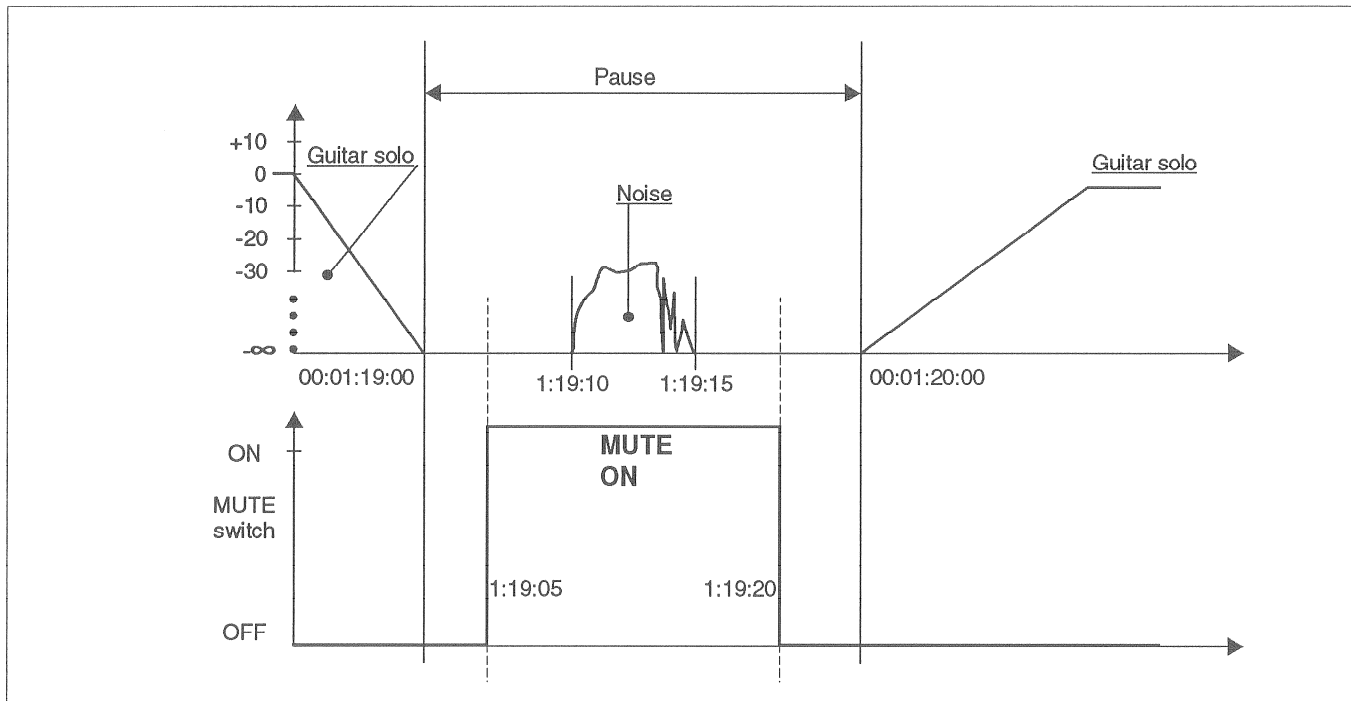

For this case the setting is as follows:

Active *Punch In / Out* activated.

In 00:01:19:05 Automatic punch in, WRITE / UPDATE previously defined with ACU. If necessary set write zone *From...* to the same value.

Out 00:01:19:20 Punch out.

Fader *Punch In / Out* does not relate to fader.

Switches Active, because *Punch In / Out* should relate only to switches.

- [9] Time code display; the current or running time code is displayed when **ONLINE** is active.
The display is only updated when the system is switched to **ONLINE**.
The display is also visible in other pages.

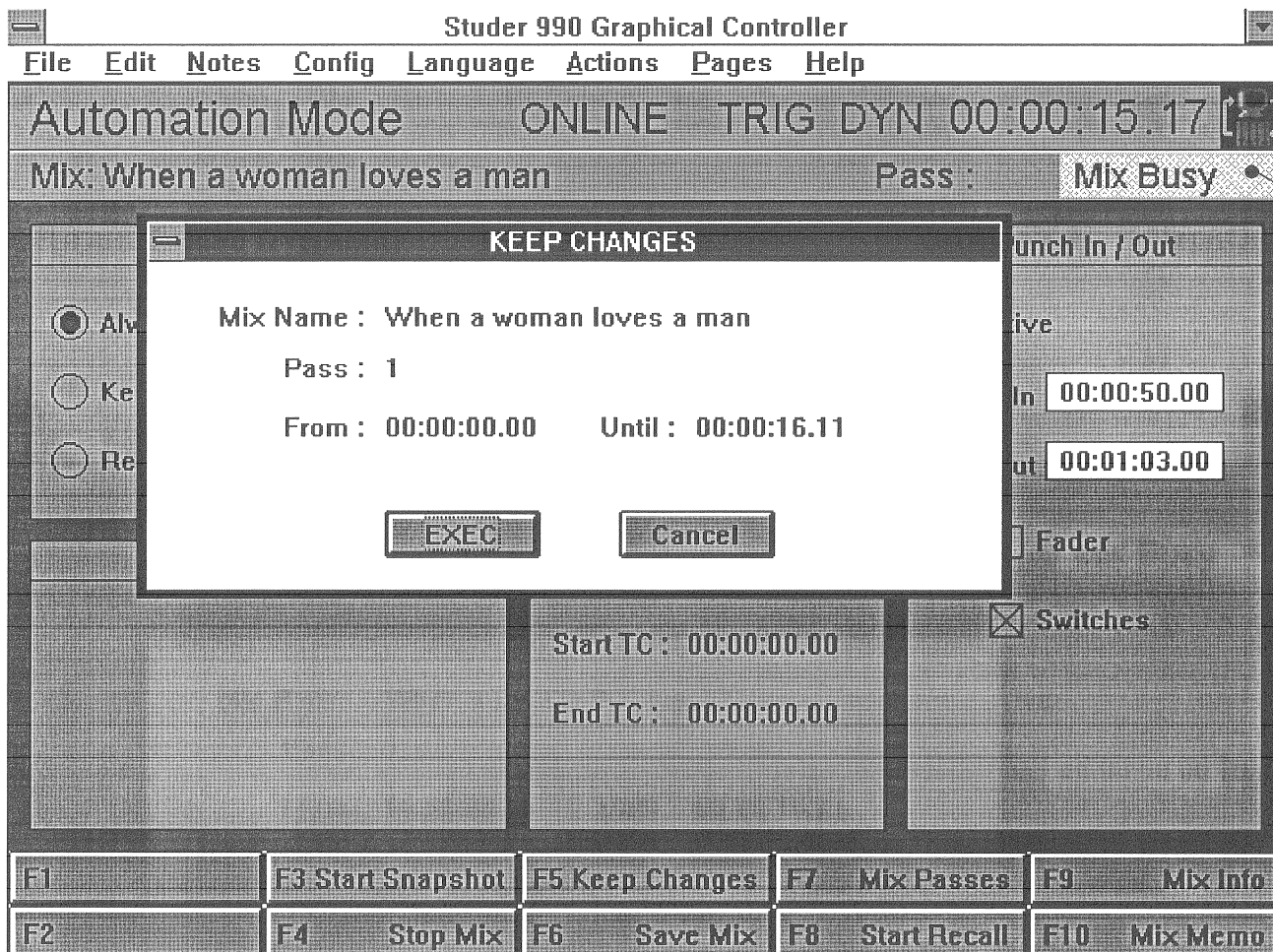

[10] The automation state during **KEEP CHANGES** is **Mix Busy**. This box remains on the screen as long as the dialog is not confirmed by **EXEC**(ute) or **Cancel**.

Other states are:

Mix Ready	Displayed when system is ready
Mix Running	Displayed when system is in use
Mix Busy	Displayed during save operations
Not Loaded	Mix cannot be loaded

[11] **Mix Memo**. When clicking into this field an input field is opened for entering notes to the current mix. See also **Mix Memo** (F10). These memos are stored together with the mix. See also **Save Mix** (F6).

[12] **Start Snapshot** (F3). The beginning of each mix is the start snapshot which is defined whenever a new mix is created. Alternatively you can open a selection box with **Start Snapshot** (F3) in which all existing snapshots and presets are listed. One of these can be opened and used as the new start snapshot.

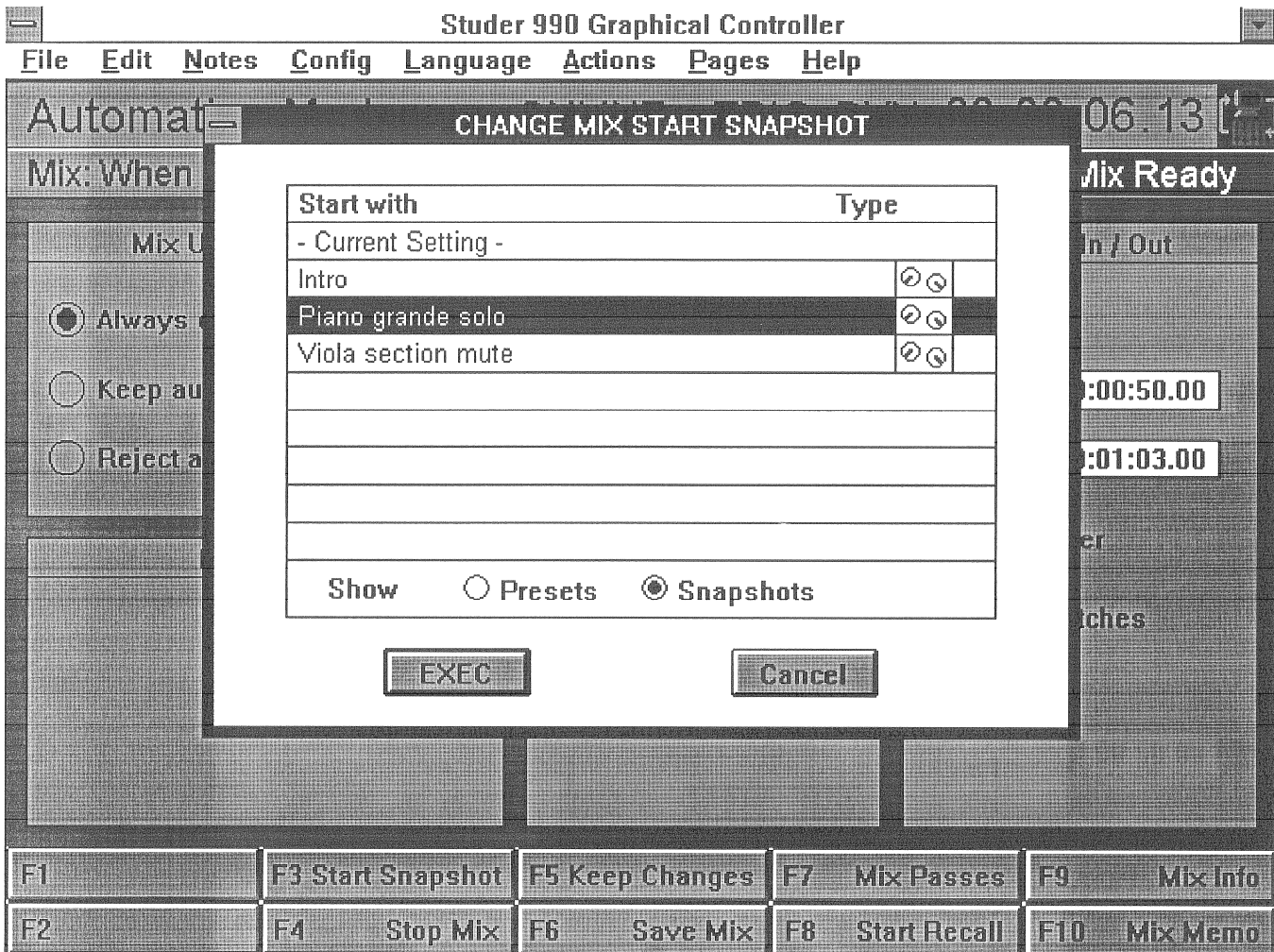

- [13] **Stop Mix** (F4); this function cancels the current mix pass (write or replay). If mix data have been generated, the box **KEEP CHANGES** is called in accordance with the preselection under [2] **Mix Update Changes**.
- [14] **Keep Changes** (F5); if **Keep automatically** is selected under [2] **Mix Update Changes**, this mix pass is not saved on the hard disk of the mixing console and not saved as an entry in the list. However, since a so-called scratch file is created on completion of each mix operation that produced mix data, it is still possible to save a successful mix pass with the function **Keep Changes** (F5).
- [15] **Save Mix** (F6); with this function key you can store the mix pass (= current mix) existing in memory on the PC hard disk of the GC.

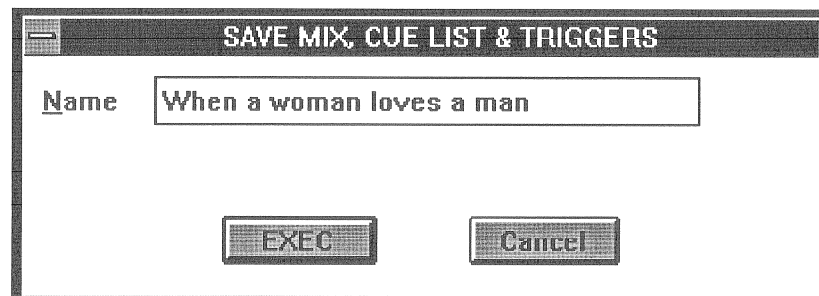

At the same time the cue list and triggers are saved.

In the confirmation box also the mix name is displayed which can be changed, if desired.

An inquiry whether or not the current mix is to be saved (on the PC hard disk) is also displayed when:

- A new mix is opened or created
- A new title or production is opened
- Auto save time has run down
- The menu items **File - Save** (Ctrl S) or **File - Save Title...** (Ctrl T) are called
- GC is terminated.

[16] **Mix Info** (F9); clicking in this field opens the input field (see also [19]).

[17] **Mix Passes** (F7); when this function is called a list containing all mix passes is opened.

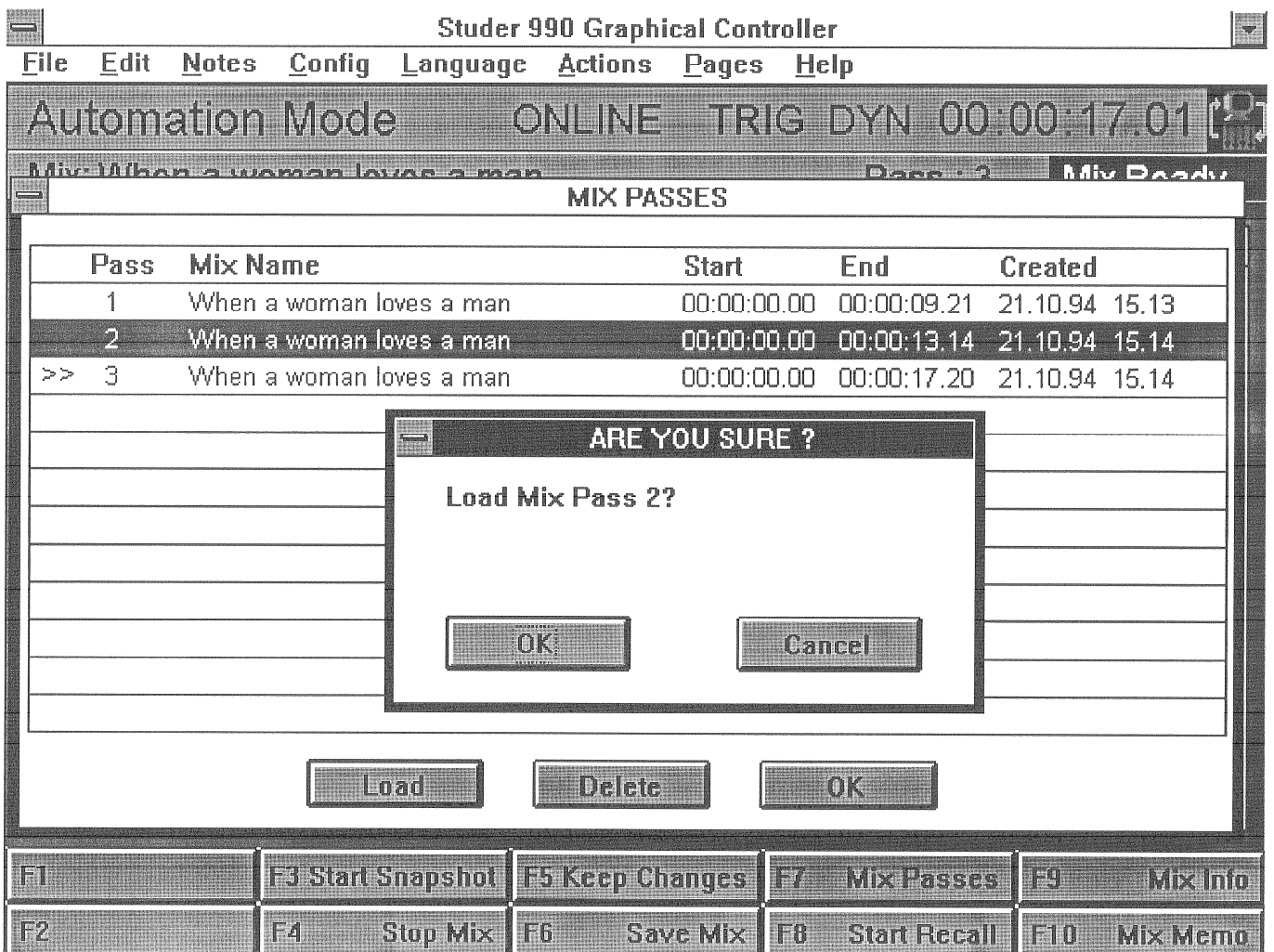

The mix passes are numbered and identified with the mix name, start and end value, as well as the date and time of creation. The current mix pass is identified with a double arrow >>.

Using this list you can load mix passes from the hard disk of the mixing console into working memory (function **Load**), either by clicking on the desired mix pass (black background) followed by **Load**, or by selecting the desired mix pass with a double click.

Mix passes can be deleted with **Delete** (first click on the desired mix pass).

The "Load" and "Delete" functions must be confirmed. In the confirmation window you can choose either "Cancel" or "OK".

- [18] **Start Recall** (F8); this key initiates a recall of the potentiometers. The recall relates to the selected mix start snapshot.
This recall is not possible, for example, when a mix is being saved (status *Mix Busy*), or when a mix is being created and replaced (status *Mix Running*).
- [19] **Mix Info** (F9); opens a box in which all relevant data concerning the current mix are displayed.

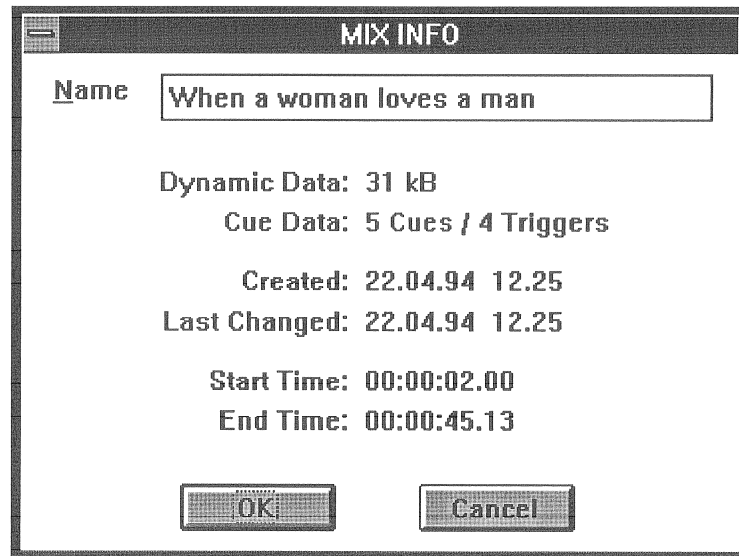

The name of the mix pass can be edited as well.

The same box is opened when *File - Information...* is chosen; in order to do this, automation mode must be active, because this menu option is context dependent.

- [20] **Mix Memo** (F10); opens an input field in which notes can be attached to the current mix pass.
Corresponds to [11].

4.2 Creating a New Mix

The procedure for creating a mix is described.

Reference is made to ACU (Automation Control Unit) operating procedures. It is assumed that a production and a title have been opened.

Configure the mix options, if this has not been done yet (see 3.1).
The mix options settings are part of the personal configuration and are saved under the name of the corresponding user.

The necessary system settings must be made (see also 3.2):

- Time code format
- Time code source
- Move clock setting.

All these system settings are saved together with the current title.

In a check box you can select whether or not the time code settings are to be saved together with the title. A corresponding check box is also offered when a title is opened.

In this way you can define whether or not the saved system settings are to be opened together with the title.

The opened time code settings overwrite any existing system settings.

Creating a new mix is possible only from the **Automation Mode** page. Changing to the **Automation Mode** page is performed as follows:

- Menu option **Pages - Dyn Auto** (Ctrl F6)
- On the keyboard: DYN AUTO
- On the keyboard: DYN ON/OFF (automation is simultaneously active; also refer to 4.1).

A new mix can only be created from the menu option *File - New* (Ctrl N).
The box **NEW MIX** is displayed.

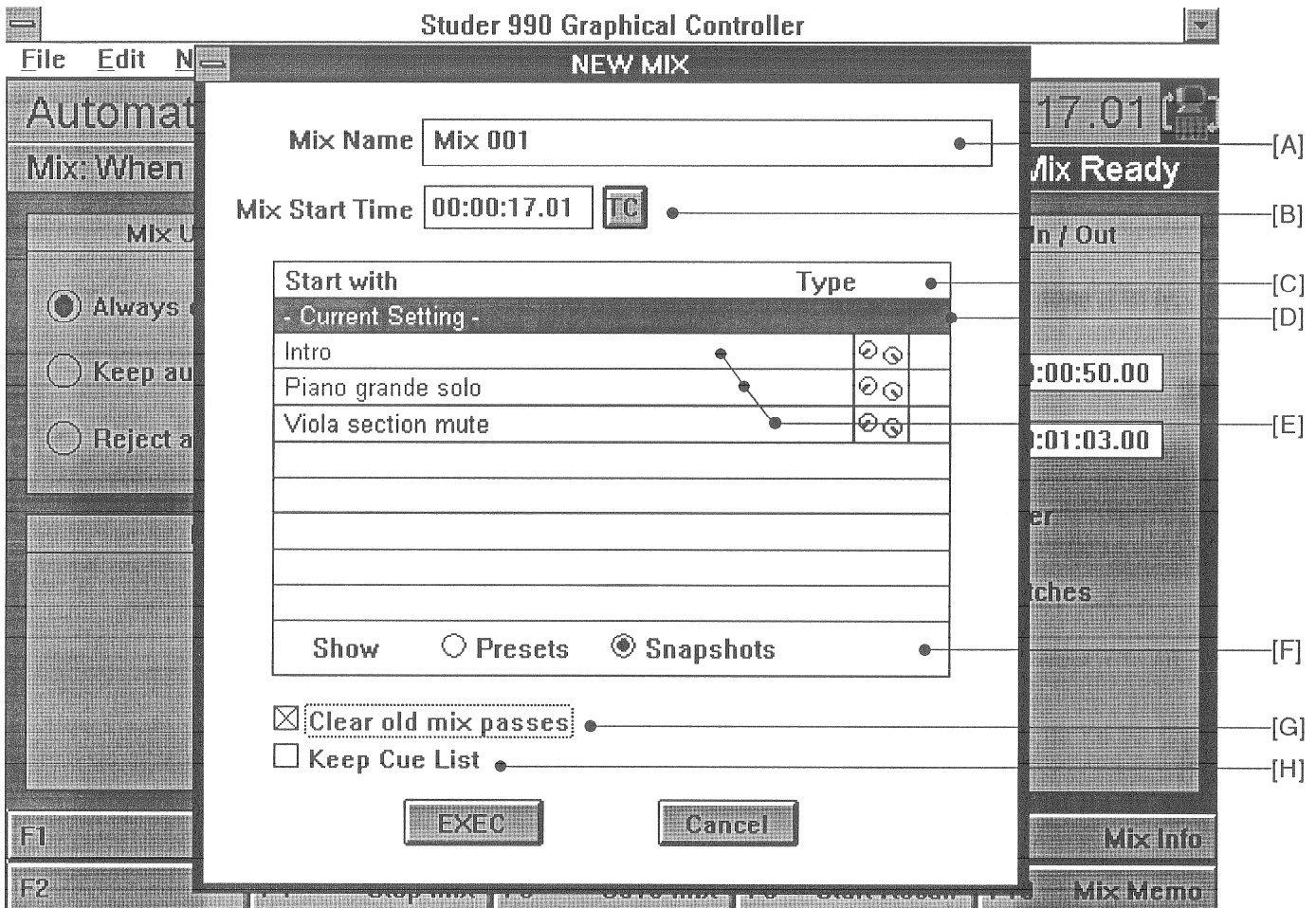

In this box define the following parameters:

- [A] **Mix Name.** A default name is suggested which can be modified if desired.
The **Mix Start Time** field is focussed after the definition of the name (default or new). The user is prompted to insert a new start time or to confirm the one already existing.
- [B] Clicking on the **TC** command button will open an input field.

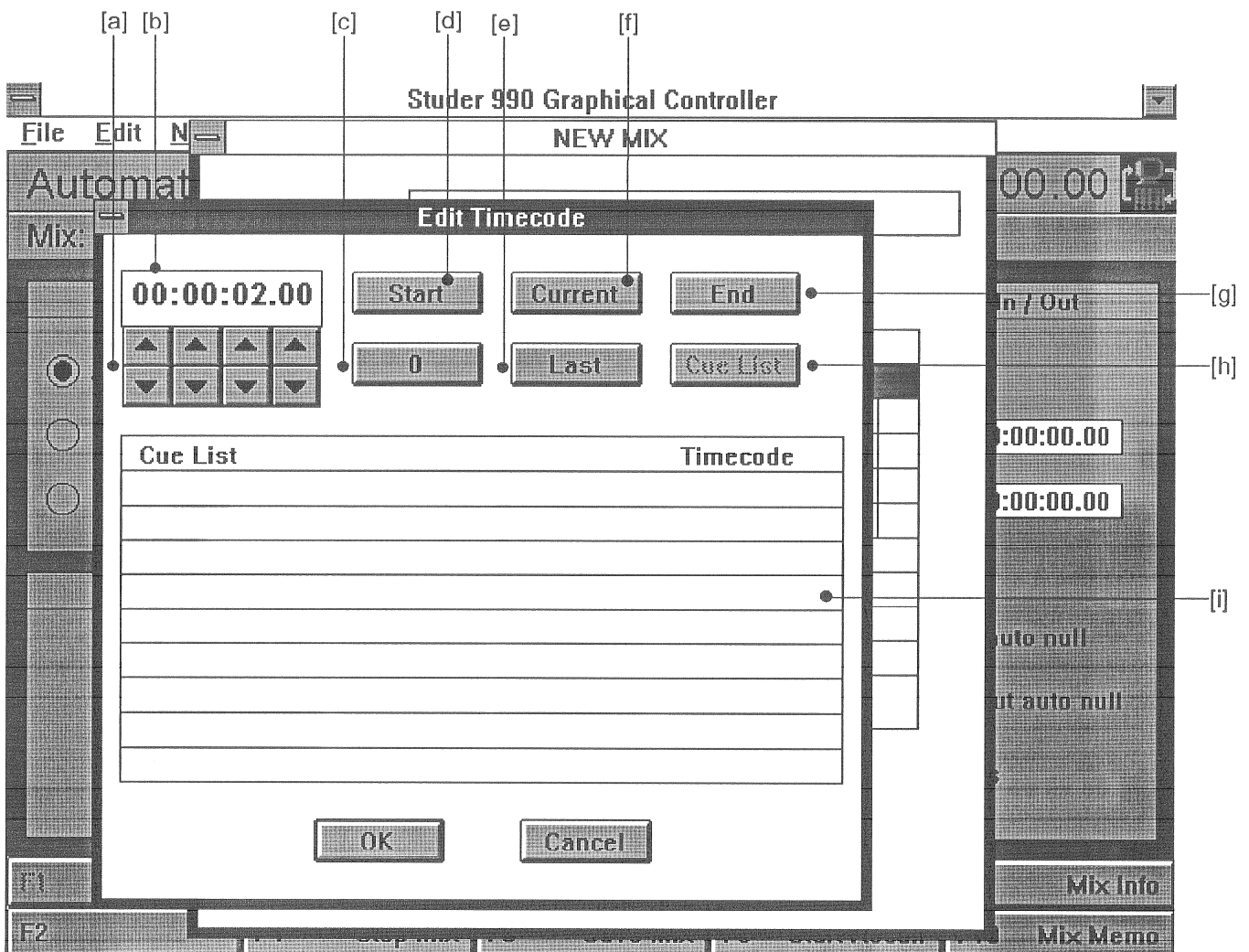

The time code in the time code window [b] can be edited via the keyboard, or with the arrows [a] below.

Another convenient method of accepting time code information, for example, from cue points, is offered by the command buttons [c] to [h].

Command button **0** [c] sets the time code to 00:00:00:00. **Start** [d] transfers the start time, and **End** [g] the end time of the title into the time code window (defined in the title info, can be called up via the *File - Title Info...* menu option, or with command button F3 starting from the list page). With **Last** [e] you can recall the last time value that has been used. With **Current** [f] the currently available time code is loaded.

With command button **Cue List** [h] time code values can be loaded from the cue list [i]. This command button is inactive in our example because no cue points have been defined yet.

With a double-click on an entry in the cue list its time code value is loaded as the start time for the mix.

The **Edit Timecode** box is displayed in various other applications, practically each time when time code is edited.

- [C] **Start with - Type:** The start snapshot can now be defined.
This list contains all snapshots that can be used as Start Snapshots. Presets can also be selected as start snapshots. Only one of the snapshots can be defined as the start snapshot.
- [D] When you click on - **Current Setting** - the system uses the current mixing console configuration as the start snapshot.
- [E] Of course, all snapshots that belong to the title are available for selection.
- [F] **Show:** Here you can select whether **Presets** or **Snapshots** are to be displayed. If **Presets** is chosen, the presets appear in the list and are available for selection.
- [G] **Clear old mix passes:** When this check box is active, all mix passes which have been created, but not stored to the hard disk of the mixing console will be deleted.
- [H] **Keep Cue List:** Here you can define whether the possibly existing cue list (from a previous mix) is to be used for the new mix, or rejected.
(In this example this item is not active because there are no cue point entries in the cue list).

With **EXEC(ute)** the entries are accepted. The box is then closed. **Cancel** rejects all entries and closes the box.

The GC must now be set to the **ONLINE** state so that the incoming time code will be read (displayed in the status line).

- Menu item **Actions - On Line** (Shift F1), or
- via the keyboard: ON / OFF LINE
(see also 4.1, [3]).

The automation must now be activated as follows:

- Menu item **Actions - Dyn On** (Shift F3), or
- via the keyboard: DYN ON/OFF
(see also 4.1, [7]).

In the last step, before the mixdown can begin by starting the time code, the desired fader and switch modes must be defined via the ACU.

However, this still depends on the selected mix options.
(Mode settings: see 5.3 and subsequent sections).

4.3 Automation of the Small Faders

4.3.1 Operating the Small Faders

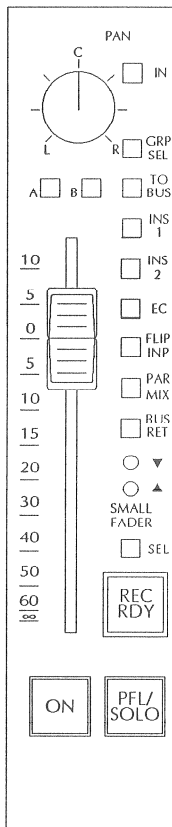

In order to automate a Small Fader (SF) it has to be switched over to the Main Fader (MF).

The Small Fader can be used the same way as the Main Fader to control a VCA, except that only the two arrows are provided to indicate the VCA mode. The complete Small Fader state can be operated with the display elements and the controls of the Main Fader (routing excepted).

The display elements and controls of the Main Fader indicate the VCA state of the Small Fader when the <SF> indication is on. In this situation the Main Fader cannot be operated. Should an offset indication on the SF be active it is related to the knob position of the Main Fader.

Switchover from SF to MF:

After having swapped the faders the Main Fader display indicates the Small Fader state. All VCA-related functions of the Main Fader keys GRP, STAT, SEL, and ON can be operated; they will be effective on the Small Fader. All other fader functions remain in the Small Fader display and can be operated from there, too.

Keys:

GRP (Main Fader)
+ SEL (Small Fader)

Functions:

Pressing the Main Fader GROUP key and the Small Fader SELECT key simultaneously will edit the Small Fader state on the Main Fader. The <SF> indication on the Main Fader is on. Pressing the two keys a second time switches back to the original state. Should a motorized fader be used, it temporarily adjusts to the Small Fader VCA position.

As soon as the SF is switched over to the MF it can be automated exactly as the Main Fader. Functions adjusted on the ACU are now effective for the Small Fader. After having written the SF mix data the faders can be swapped again.

- SF and MF cannot be written simultaneously.
- It is of advantage to create a snapshot with the standard MF positions and swapped SF→MF functions.
- At Small Faders automation the start snapshot has to be set with the swapped functions (SF to MF).
- Main Faders being in the background are either in the ISOLATE or the ISOLATE ENABLE mode. This depends on the mode setting during the fader exchange.
- If the fader exchange is executed while the MF is in READ, WRITE, or UPDATE mode, the MF is set to the background in ISOLATE ENABLE mode (MF mix data are replayed).
- Generally, a fader being in the background can never be in an active WRITE mode.
- The Small Fader adopts the MF mode.
- If the faders are swapped while the MF is in ISOLATE mode, the MF will remain in this mode while being in the background (no MF mix data will be replayed).
- If ISOLATE mode is selected on the ACU while the MF is being in the background, it will be set to ISOLATE mode as well.

5 Automation Control Unit (ACU)

5.1 Introduction

The various automation modes of the switches and faders are set with the ACU.

This unit remains inactive until automation is activated in the GC program (*DYN ON*).

The ACU serves as an input and display device.

It is subdivided into three areas:

- Control of fader modes and functions
- Control of switch modes and functions
- Global functions and displays

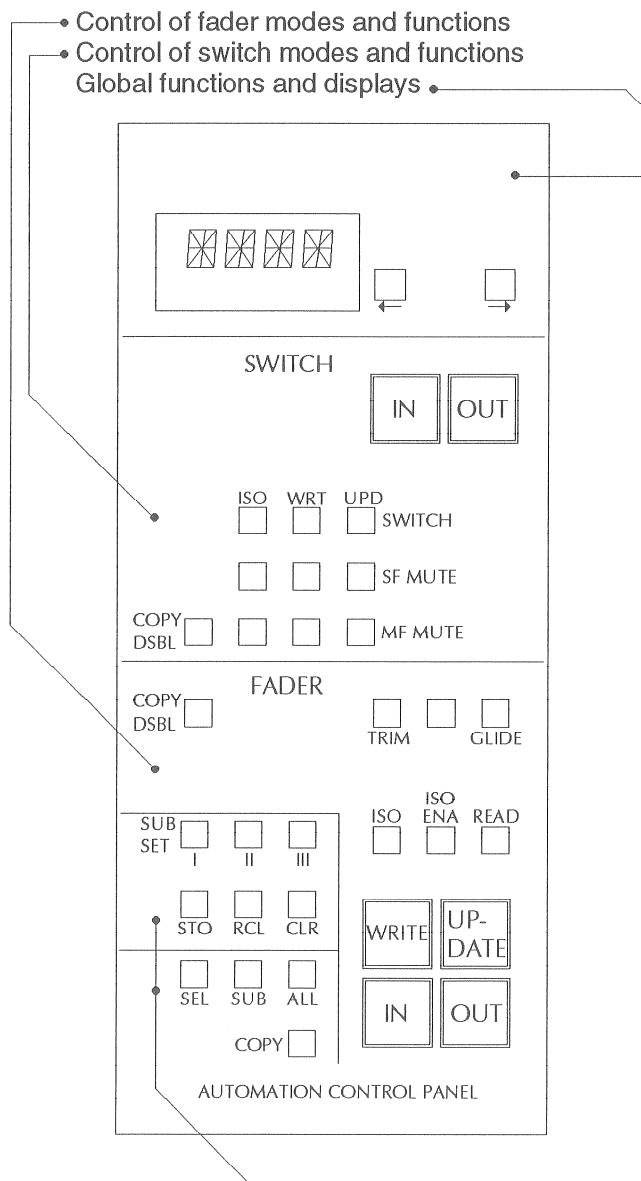

5.2 Operation

5.2.1 Setting the Automation Modes

The following automation modes are available: (see also 5.3)

<input type="checkbox"/> WRITE ENABLE	(WRT ENA)	Preparation for writing
<input type="checkbox"/> WRITE	(WRT)	Active writing (overwriting)
<input type="checkbox"/> UPDATE ENABLE	(UPD ENA)	Preparation for relative writing
<input type="checkbox"/> UPDATE	(UPD)	Active relative writing
<input type="checkbox"/> ISOLATE ENABLE	(ISO ENA)	Replay of mix data
<input type="checkbox"/> ISOLATE	(ISO)	Mix data are not executed
<input type="checkbox"/> READ		Replay of fader data only

Except for the READ mode which applies only to the faders, all other modes are available for faders and switches.

The automation mode setting depends always on the selected destination area [3].

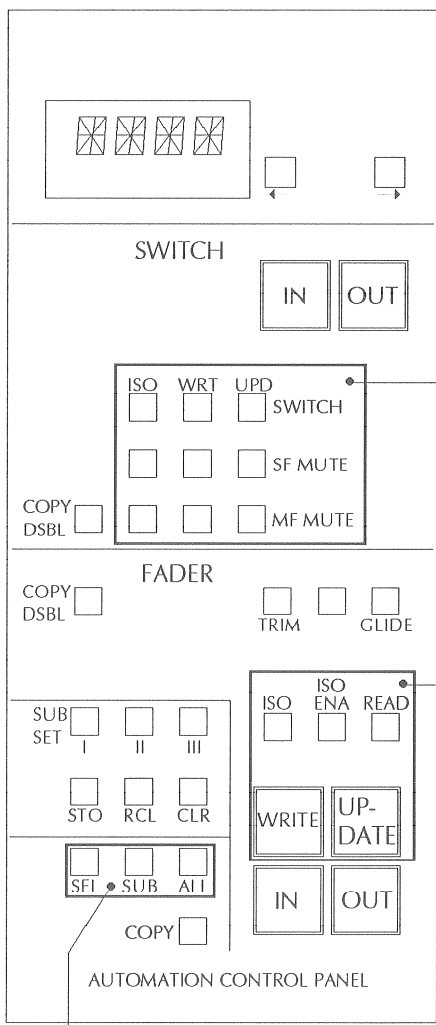

The mode for faders and switches is set by pressing the desired mode key in the fader area [1]. The corresponding keys light up.

Independently of the selected fader mode a different mode can be set for the switches by means of the keys in switch field [2].

The switches are subdivided into three fields.

- MF MUTE Mute function of the Main Faders
- SF MUTE Mute function of the Small Faders
The Small Faders exist only in inline consoles. On inline consoles without Small Faders the small fader mode can be activated on the ACU, but without effect.
- SWITCH All other switches (EQ, INS, etc.; including input gain)

For each of these switch groups a different automation mode can be selected.

On the channel, modes set differently for faders and switches are indicated by the LCK (LOCK) lamp.

5.2.1.1 Example for Automation Mode Setting

The faders shall operate in WRITE mode, MF MUTE in ISO mode.

Press WRITE in the FADER field: →

ISO in the SWITCH field:
Press MF MUTE

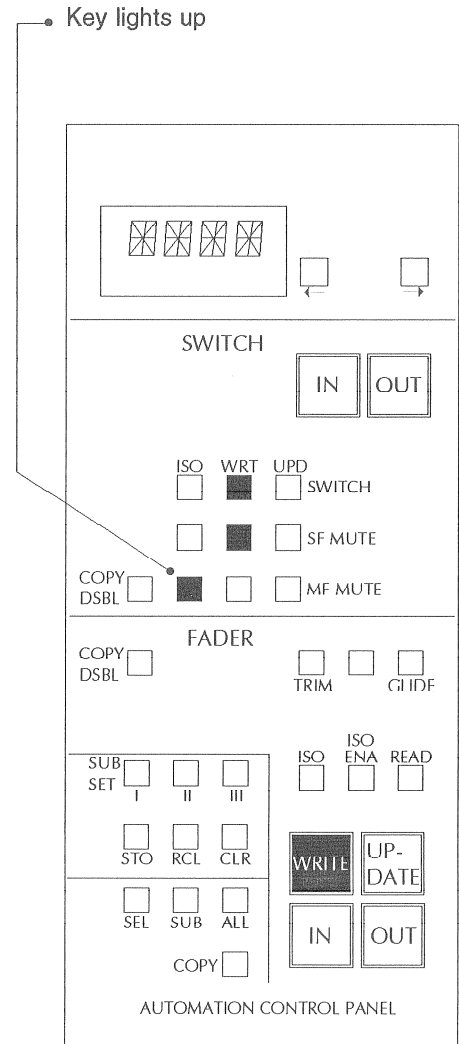
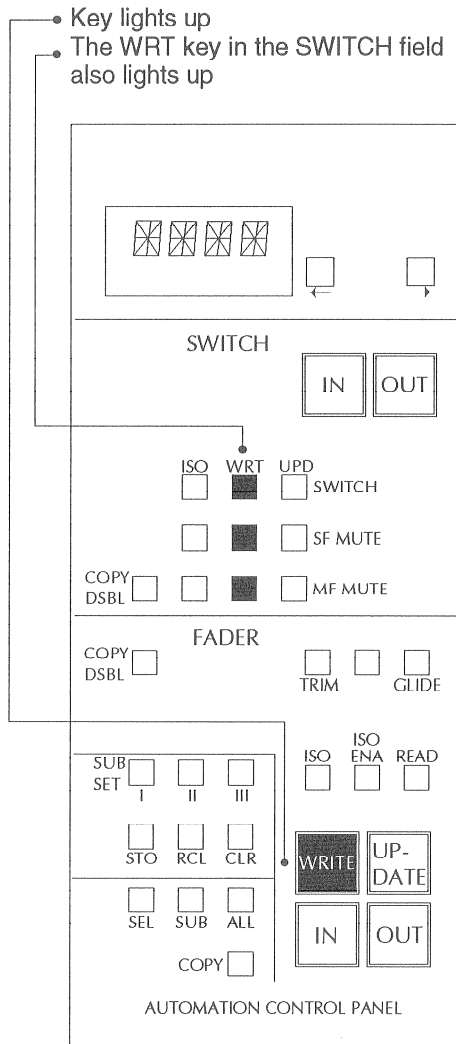

Depending on the destination area the modes set on the ACU are transferred to the faders.

5.2.2 Creating SUBSETs

Several channels can be grouped into max. 3 subsets.

When subsets are created, several channels can be processed simultaneously by the ACU (for example, setting and copying automation modes, activating/deactivating an active write mode).

The subsets can be stored and recalled as required..

Only one subset at a time can be established on the mixing console. As soon as the destination area SUB is active on the ACU (also refer to 5.2.3), the ACU is logically coupled to all channels on which the lamp in the SUB key [1] is on.

Creating a subset:

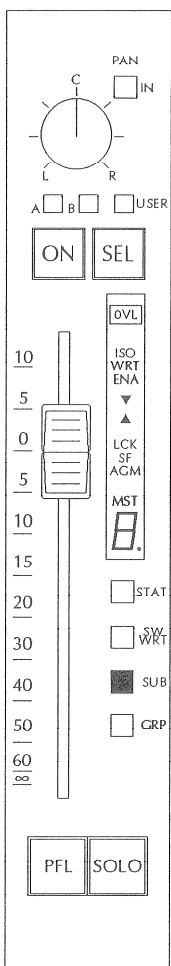

- Press the SUB key on the fader units to be included in the subset. The key lights up.

Storing the subsets in memory locations I, II, III

- Subset created on the console
- Press STO key, then the desired memory location I, II, III
- Existing subsets in the memory locations are overwritten

Recalling a subset

- Press RCL, then choose the desired subset I, II, III
- On the fader units the SUB keys belonging to the selected subset light up

Deleting a subset stored on the console

- Press CLR key

Deleting a subset stored in memory

- Press CLR key
- The subset on the mixing console is canceled
- Press STO key and the desired memory location

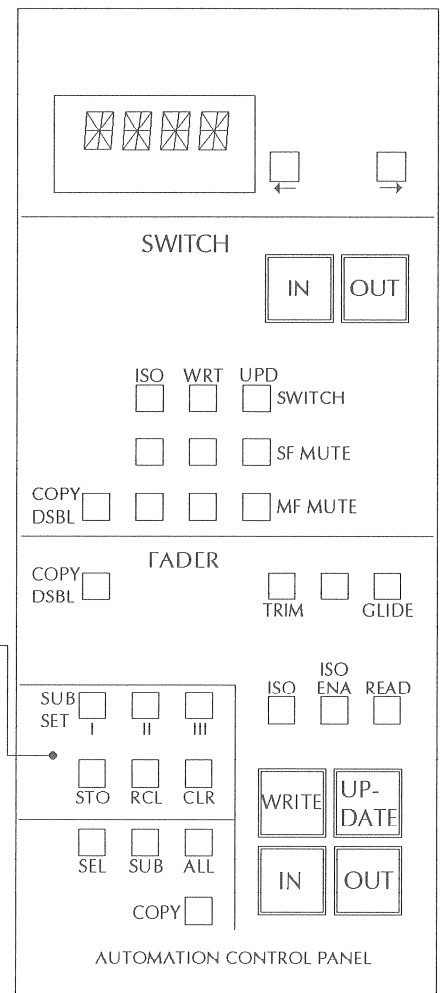

5.2.3 Destination Area Keys SEL, SUB, ALL [3]

These 3 keys define the destination areas for the following functions:

- Setting the fader and switch modes
- Copying ACU settings (also refer to 5.2.5)
- IN or OUT keys for faders and switches.

5.2.3.1 Example with ALL key [3] active

- ALL is indicated in the display [1]
- The mode (for example, WRT mode) selected on the ACU is set to all channels (inputs, groups, masters).

The entire mixing console is now in WRT ENA mode.

- When the IN key is pressed in the fader or switch field, all faders or switches are set to active WRT mode
- When the OUT key is pressed in the fader or switch field, all faders or switches are changed from active WRT mode to WRT ENA mode.

In the SUB and SEL destination areas the mixing console behaves in the same manner as described in the foregoing example, except that the actions relate to the selected subset or to the selected channel.

5.2.3.2 Example Channel Selection

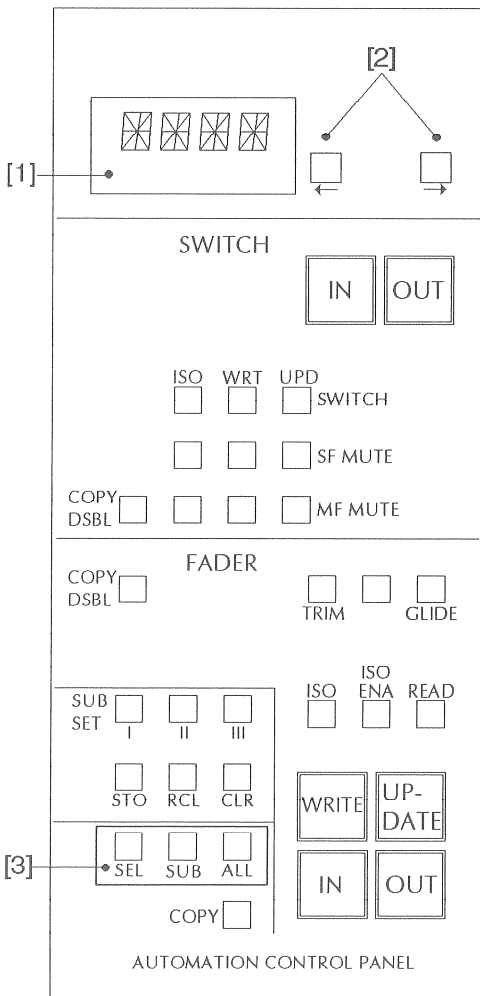

- On the ACU press the SEL key [3]
- On the desired channel press the SEL key [4] of the fader unit
 - The automation mode of the channel is shown on the ACU
 - The selected channel, i.e. input 30, is shown on the display [1]
- With the arrow keys [2] you can select a different channel. Each time the ← or → key is pressed, the channel number is decremented or incremented by one, starting from the displayed channel number.

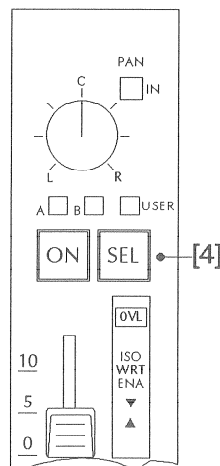

5.2.4 IN and OUT Keys

For changing the preparation mode (for example, WRT ENA) to an active write mode (WRT) the IN keys on the ACU can be used.

Returning from the active write mode (WRT) to the preparation mode is implemented with the OUT keys.

In addition to this central operation the active write mode can be switched on or off also on the fader units → also refer to 5.3.2.

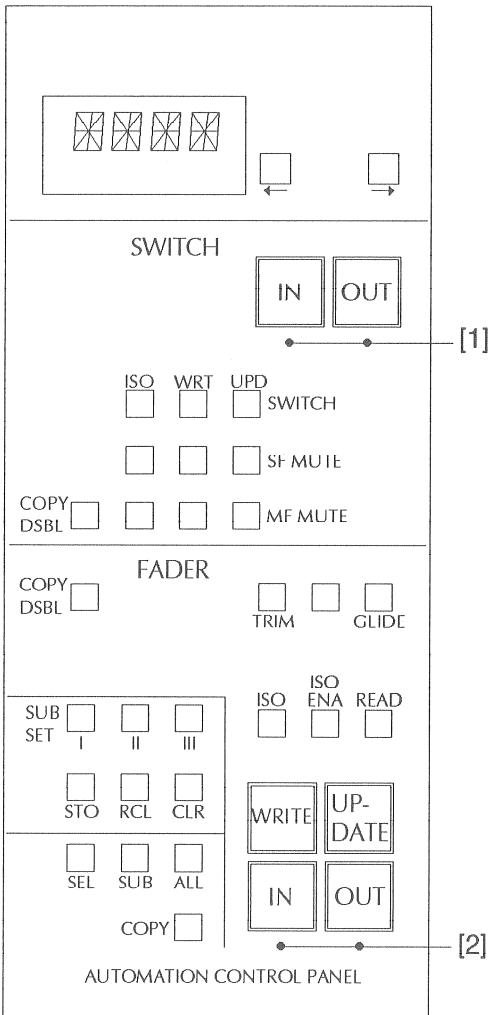

For the FADER [2] and SWITCH [1] areas separate IN and OUT keys are available. This prevents inadvertent writing of switch data if only faders are to be processed. The same applies analogously if only switch data are to be generated.

If fader and switch data are to be written simultaneously, both IN keys must be pressed. Conversely, both OUT keys must be pressed for switching off the write mode.

Exception: If in the mix option the active WRT mode was selected after the setup of a new mix (see 3.1), the switches and faders are already in active write mode.

- The effect of the IN and OUT keys depends on the destination keys SEL, SUB, ALL.
- The IN key lights up as soon as any channel of the mixing console is in an active write mode.

5.2.4.1 IN/OUT Keys in Conjunction with PUNCH IN/OUT (see also 4.1 [8])

The IN and OUT keys are also used for signaling the programmed PUNCH IN/OUT.

Before the automatic punch in, the IN key on the ACU flashes for approximately 5 seconds. After automatic (or manual) punch in, the lamp of the IN key is continuously on. When the automatic punch-in point has passed, the OUT key flashes to signal the impending automatic punch out.

5.2.5 Copy Function

Automation modes can be transferred from one channel to other channels.

- In conjunction with the copy function, the
- Destination keys SEL, SUB, and ALL [3],
 - COPY key [4], and
 - COPY DSBL keys [1], [2] are needed.

COPY DSBL (Copy disable) = copying not possible. This function can be individually selected for switches or faders.

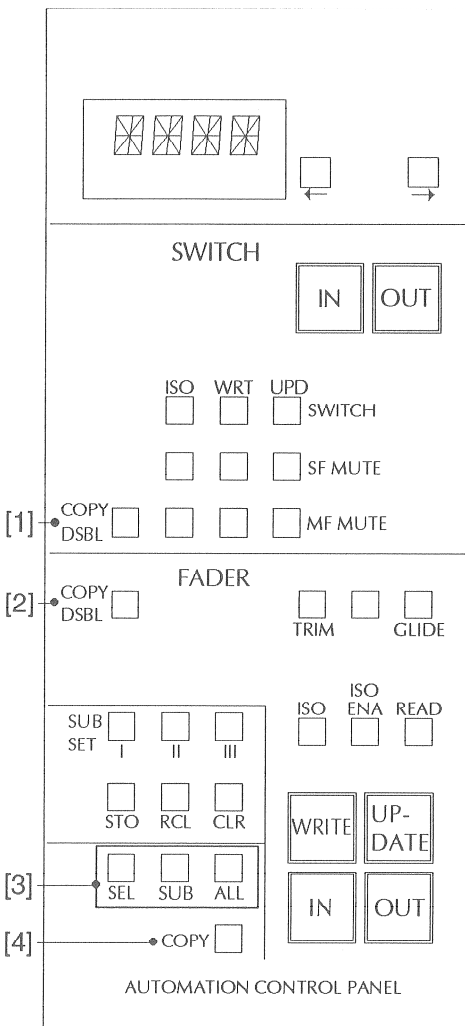

The COPY key [4] can only be operated if a channel is selected on the ACU [3].

If SUB or ALL [3] are active, the COPY key has no function.

Example:

The automation mode of channel no. 30 shall be copied to a subset (the subset is already set up on the mixing console).

- Press SEL key [3]
- Press SEL on the fader unit no. 30
- Activate the COPY key [4]
→ The key is illuminated
- Press SUB key [3]
→ The setting of channel no. 30 is copied to this subset.

When the COPY DSBL key is active, no automation modes are copied in the corresponding control field (SWITCH or FADER).

If the ALL key [3] is pressed instead of SUB, the setting of the corresponding channel is copied to the entire mixing console.

If the SEL key [3] is pressed during the last step of the copying process, the SEL [3] and COPY [4] keys flash.

→ By pressing the SEL keys on the fader units the setting of the selected ACU channel can now be copied to the corresponding channels.

5.2.6 TRIM function

The TRIM key on the ACU can only be operated if the mixing console is equipped with non-motorized manual faders.

The default setting for the TRIM function is ON.

When you switch from a preparation mode to the active write mode, the active TRIM function prevents a jump if the fader position and the VCA value of the automation are different.

5.2.6.1 Example with TRIM (also refer to 5.3.2.2)

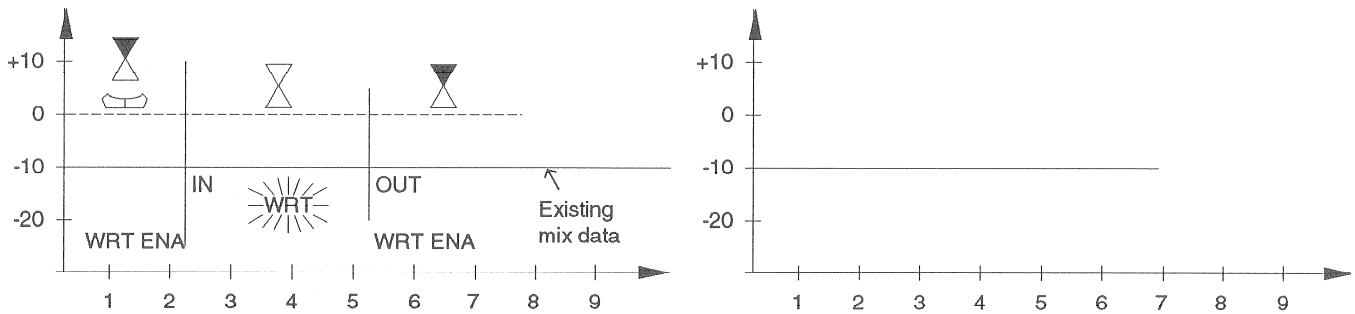

- Fader in 0 dB position
- Existing mix data: -10 dB
- Start TC
- Up to "2" in WRT ENA mode
→ arrow LED indicates the offset
- At "2" switch to active write
→ arrow LEDs do not indicate any offset
- Switch off with OUT
→ Offset is again displayed
- Replay the mix data
- No changes are written
- Important in this example is that activation with IN does not cause a jump even though the VCA value and the position of the fader are different.

5.2.6.2 Example without TRIM

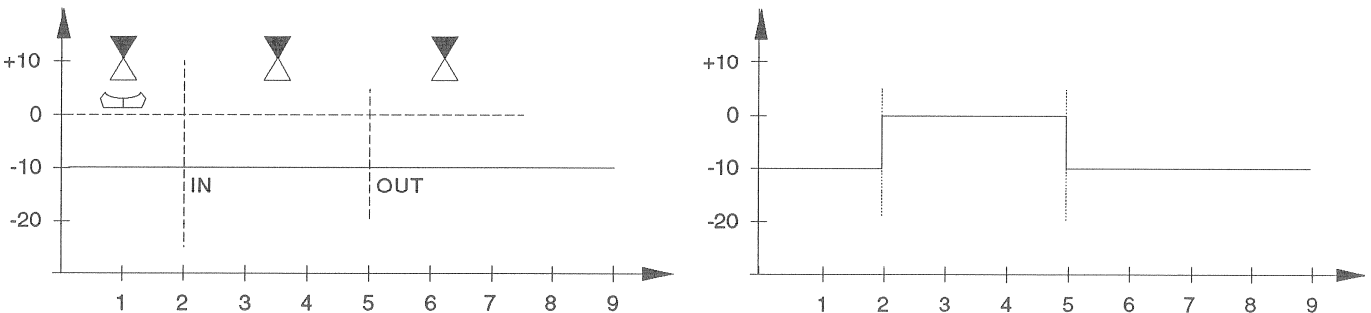

- Same example as above
- At "2" switch to active write
→ arrow LED points to the existing mix data
- After switch off "5" the VCA jumps to the existing mix data and indicates the existing offset
- Replay of the mix data
- At "2" the VCA jumps to 0 dB
- At "5" a jump to -10 dB is performed

5.2.7 GLIDE function

The GLIDE function is activated with the GLIDE key [1].

It applies to manual and motor faders.

The parameters of the GLIDE function are defined in the *Config - Mix Options* menu (refer to 3.1).

When GLIDE is active, the VCA performs a ramp at the changeover from active mode (WRT → WRT ENA, UPD → UPD ENA) with the predefined speed until the underlying mix data are reached. Active write is then deactivated (also refer to 5.3.2.1, example [4]).

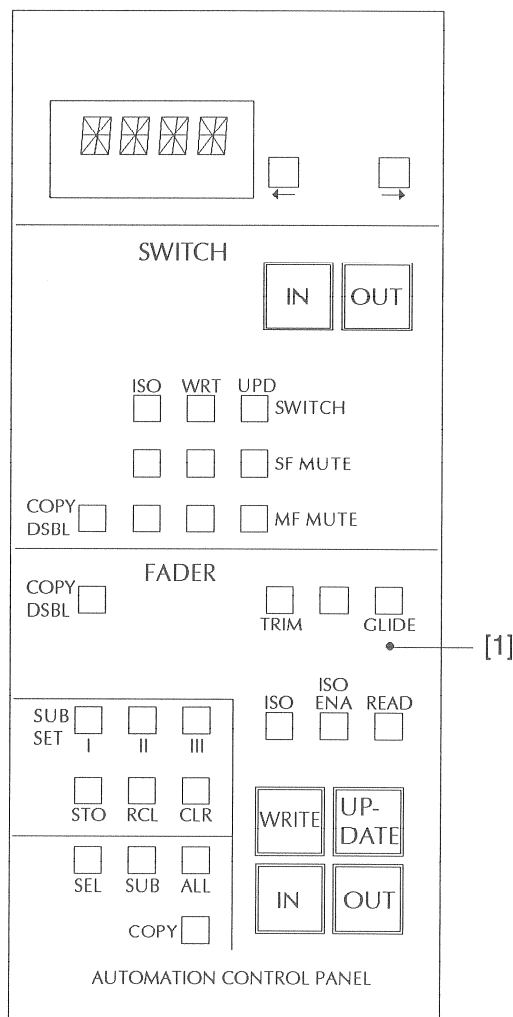

- If the mix is stopped (stop mix, stop or rewind the tape machine), no GLIDE function is performed, that is, an immediate deactivation of active mode occurs.

5.3 Automation Modes

5.3.1 WRITE ENABLE Mode (WRT ENA)

The WRT ENA mode is a precondition for switching to WRT mode. In WRT ENA mode the mixing console/channel is ready to record fader data at the desired moment.
In WRT ENA mode no data are written (but existing mix data are played back).

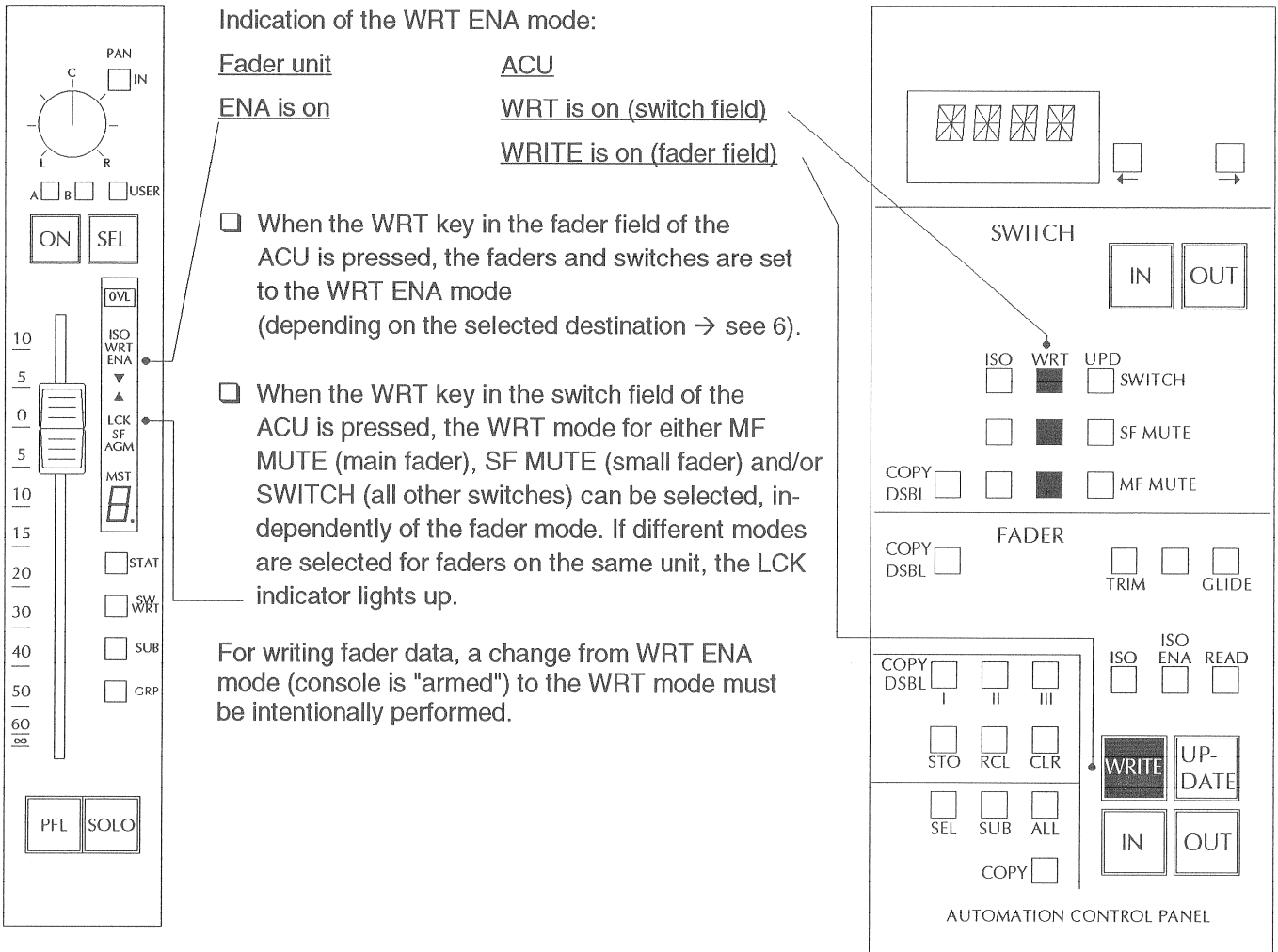

- * Touch the fader knob
- Press the STAT key on the fader unit (WRT ENA → WRT for faders)
- Press the SW WRT key on the fader unit (WRT ENA → WRT for switches)
- Press the IN key on the ACU (one key each for faders and switches)

Deactivate the WRT mode (return to WRT ENA mode) by:

- Press the STAT key (fader unit, WRT → WRT ENA for faders)
- Press the SW WRT key (fader unit, WRT → WRT ENA for switches)
- Press the OUT key on the ACU (one key each for faders and switches)

* Applies only to motor faders, but not to manual faders.

5.3.2 WRITE Mode (WRT)

The WRT mode is the mixing console status in which mix data can be written.

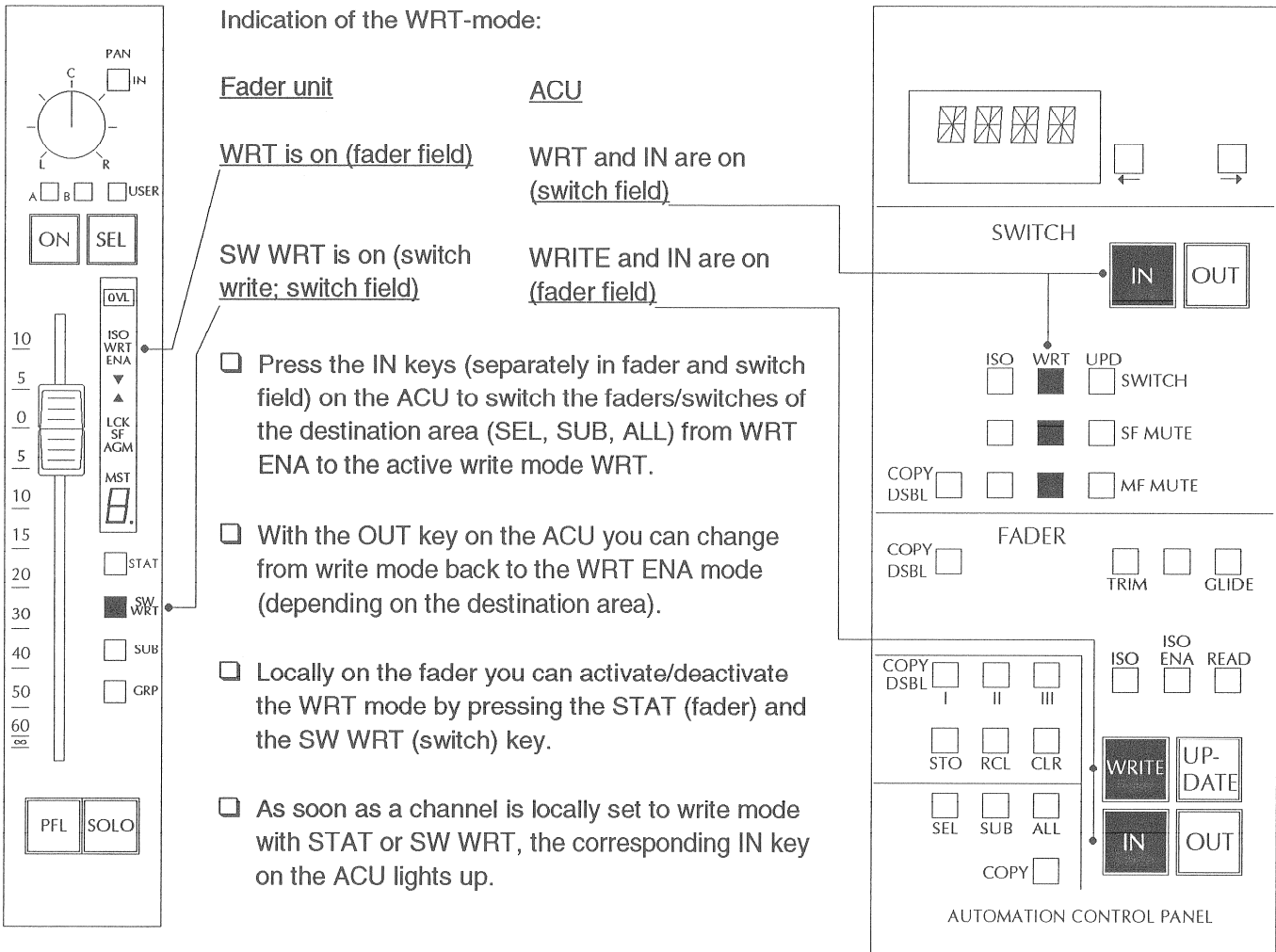

5.3.2.1 Examples to WRITE Mode (Motor Faders)

Example [1]: Writing fader data ("empty" mix)

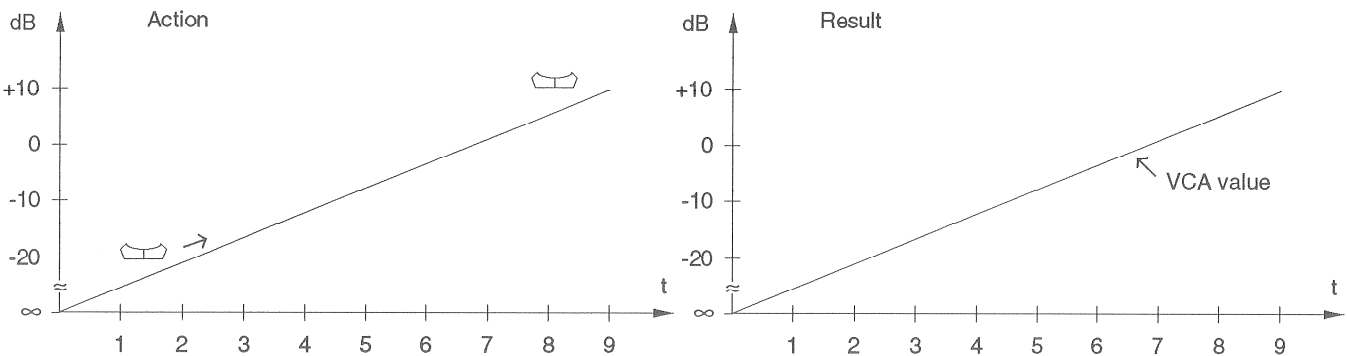

- WRT active (STAT or IN key)
- Result: Replay of the recorded data (WRT ENA)
- Activate the automation (TC running)
- Fader duplicates the movement
- Slide the fader from ∞ to +10 dB

Example [2]: Overwriting existing data

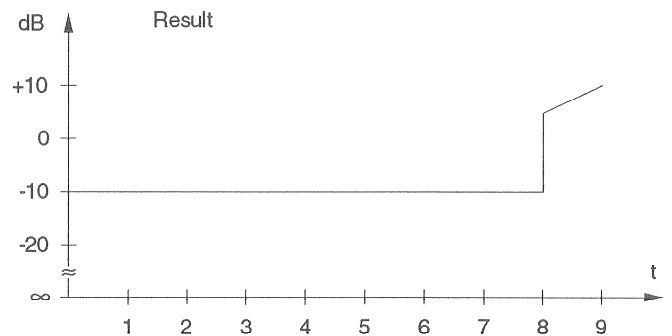
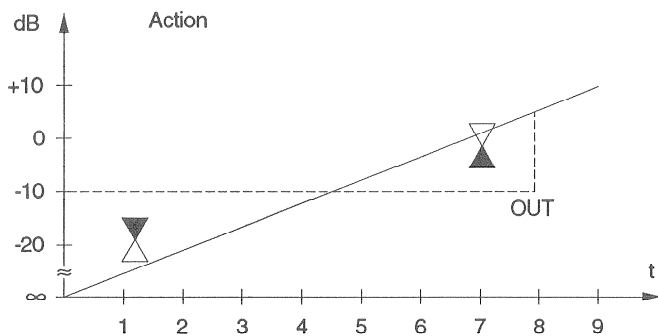

- Fader is set to -10 dB at the starting point
- WRT active, leave fader position
- TC running
- Drop out at time "8"
- The ▼ arrow on the display points in the direction of the underlying mix data (offers the possibility to drop out without jump)

- At time "8" the fader jumps to the existing mix data
- Beginning at "8": Replay of the "old" mix data

Example [3]: Overwriting of existing data

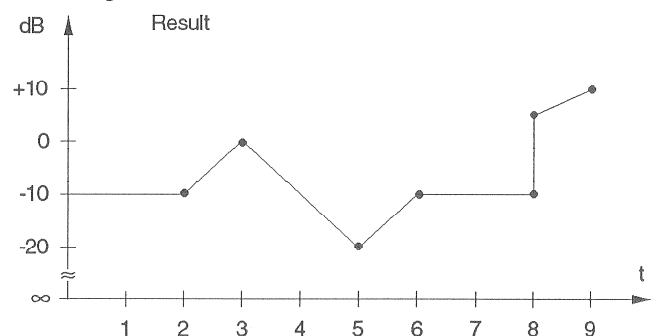
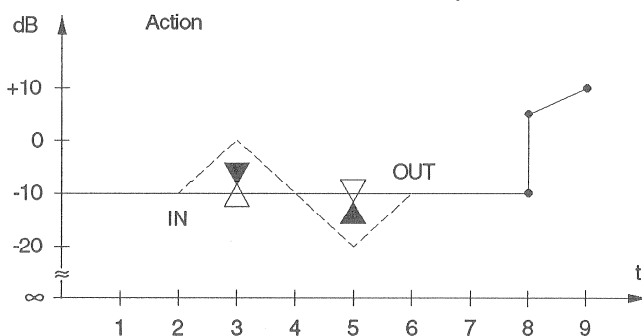

- WRT ENA (replay of fader data)
- At "2" touch (→ WRT) and slide to 0 dB, to -20 dB and back to old mix until arrow LED ("6") turns off

- Replay of the mix data
- At time "6" no jump

Example [4]: Overwriting of mix data, drop out with AUTO GLIDE (see 5.2.7)

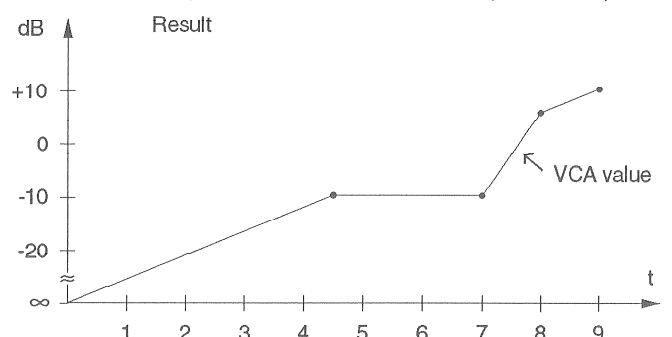
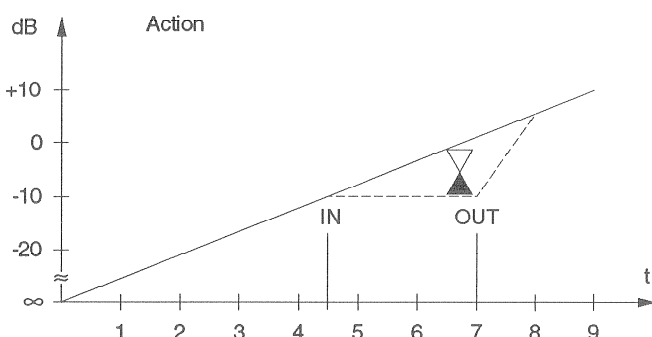

- GLIDE key active on ACU
- At "4.5" WRT (STAT or IN key)
- At "7" drop out from WRT (STAT or OUT key)
- Beginning at "7" Autoglide; fader moves in the direction of the "old" mix data (speed depends on the set value). When the "old" mix data are reached, drop-out from WRT mode to WRT ENA. The arrow LED is turned off.
- "Old" mix data are replayed.

- Replay of mix data
- Beginning at "7" a ramp is written.

5.3.2.2 Examples to the WRITE Mode (Non-motorized Manual Fader)

Example [5]: Writing of fader data ("empty" mix)

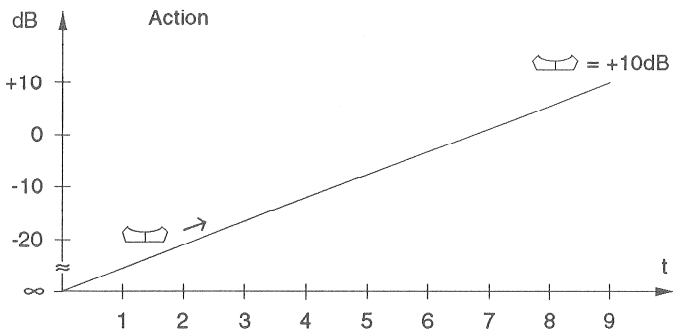

- WRT active
- TC running
- Slide the manual fader from ∞ to +10 dB
- Fader remains at +10 dB

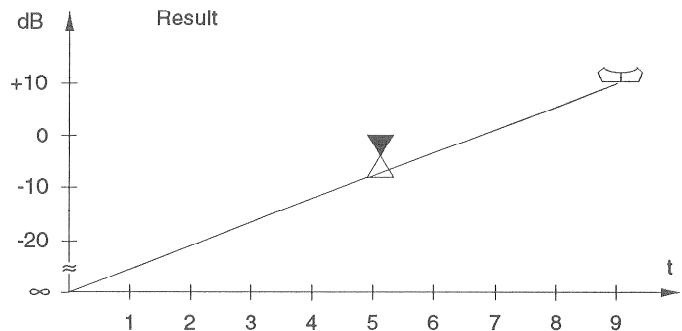

- During replay the fader does not move along, it remains at +10 dB
- The VCA, however, executes the ramp
- In WRT ENA mode, during the replay of the mix data, the fader has no influence on the VCA
- The arrow LED remains until the VCA has reached the position of the fader, or until the fader is pulled to the position of the VCA.

Example [6]: Writing/overwriting of existing data (without TRIM)

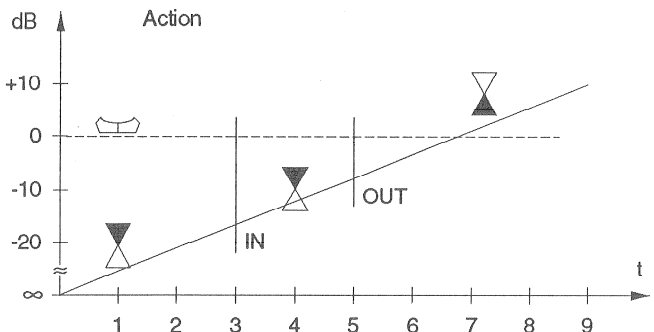

- TRIM on ACU not active (also refer to 5.2.6)
- Fader set to 0 dB position
- At time "3" switch from WRT ENA to active WRT mode
- Leave the fader in this position
- At time "5" deactivate WRT mode

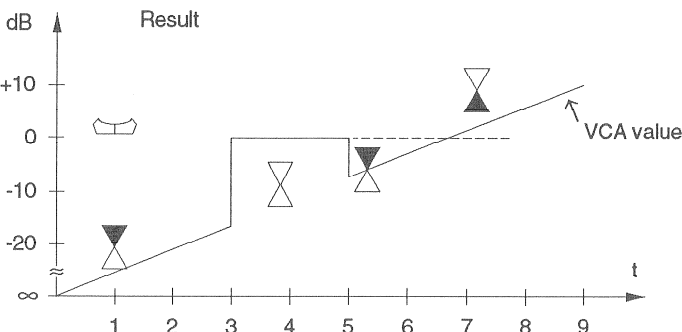

- Replay with WRT ENA
- Fader positioned at 0 dB, will not be moved
- At "3" VCA jumps to 0 dB
- At "5" VCA jumps from 0 dB to the "old" mix data
- The arrows point in the direction of the automation data; between "3" and "5" the arrows are dark.

If no TC is available on the mixing console in WRT ENA mode without the TRIM function, a zero offset is removed by pressing the STAT key twice (WRT ENA → WRT → WRT ENA), that is, the VCA jumps to the fader position.



Example [7]: Same example as 6, but with TRIM active

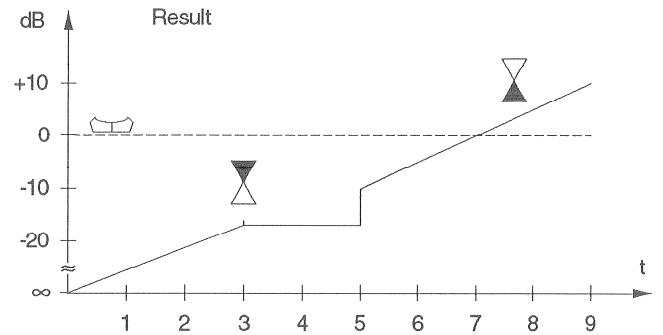
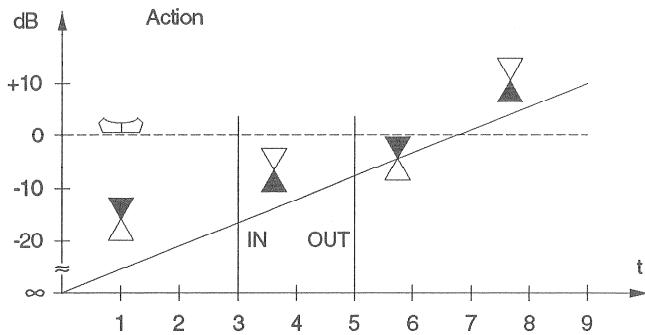

- TRIM active (default setting)
- Fader 0 dB
- At "3" drop-in to WRT
- Leave the fader in this position
- At "5" deactivate WRT

- No jump occurs at activation of WRT
- Since no matching to the VCA level is performed (fader is not moved), there is a jump when the deactivation occurs.

If no time code is available on the mixing console and TRIM is active, a zero offset cannot be removed by pressing the STAT key twice. The mechanical position of the fader can be brought into agreement with the one of the VCA by pressing the SEL key on the fader unit and by moving the fader in the direction of the arrow.

Example [8]: Correction in write mode (with TRIM)

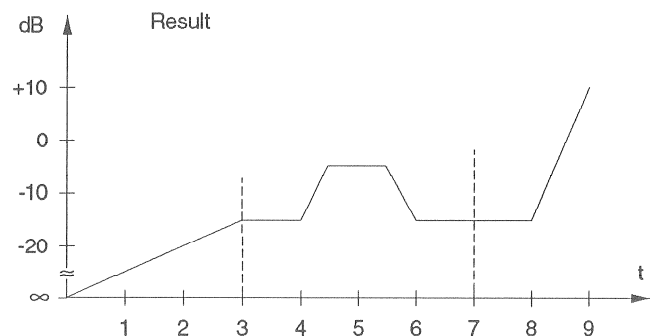
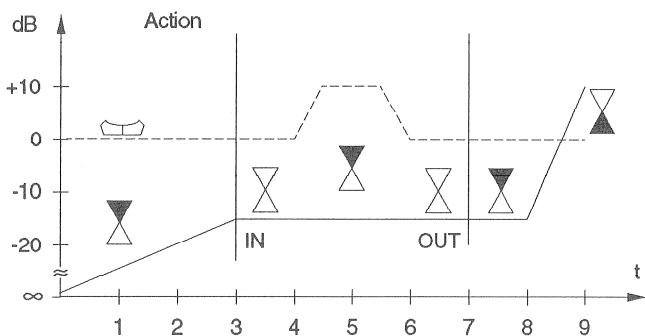

- Fader positioned at 0 dB
- At "3" activate WRT mode
- The arrow LEDs indicate that no offset exists
- Slide the fader to +10 dB; the arrow points to the previous mix data
- Move the fader back until the arrow LED is dark (\cong back to zero)
- Deactivate WRT mode ("7")
- The arrow LEDs clearly indicate the offset because the "old" data are replayed.

- Replay the data
- At "3" playback of the "old" mix
- Additional movement from "4" to "6"
- At "7" smooth transition to the previous mix

5.3.2.3 Examples with Switches in WRITE Mode

Example [1]: Writing switch data ("empty" mix)

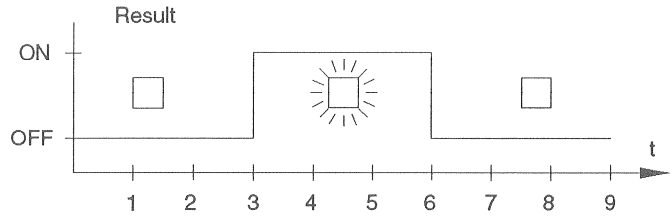
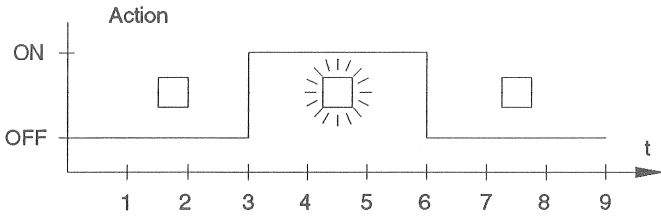

- WRT mode active (IN/SW WRT)
- TC running
- At "3" activate the key
- At "6" deactivate the key
- Drop-out with OUT/SW WRT

- Replay of the recorded switch data

Example [2]: Overwriting of switch data

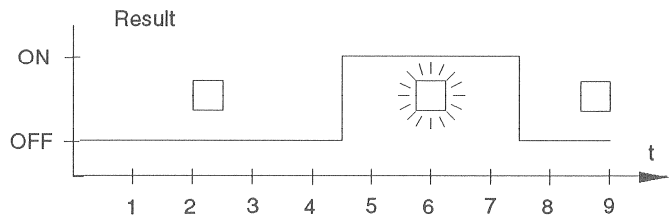
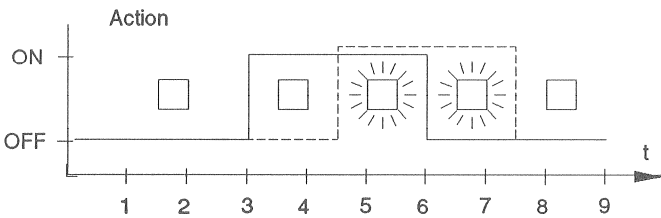

- WRT mode active
- TC running
- At "4.5" activate the key
- At "7.5" deactivate the key
- Stop mix at "9"

- Replay in WRT ENA mode
- Switch on at "4.5"
- Switch off at "7.5"

Example [3]: Activation/deactivation during a mix with switch data

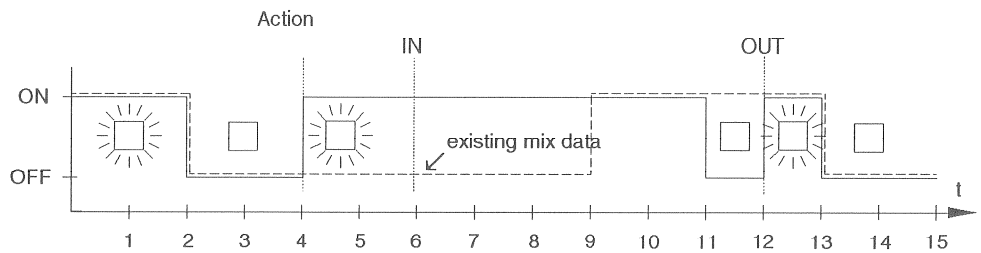

- TC running
- Replay in WRT ENA mode
- At "4" activate the key
- At "6" set active write (IN / SW WRT)
- At "11" deactivate the key
- At "12" change from the active mode to WRT ENA
- From "12" replay of the existing mix data.

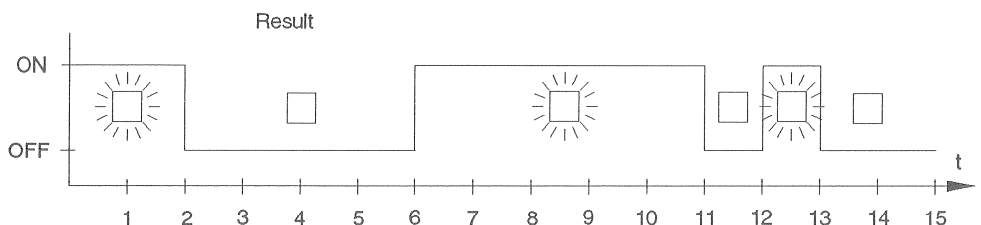

Example [4]: Activation/deactivation if no switch data exist

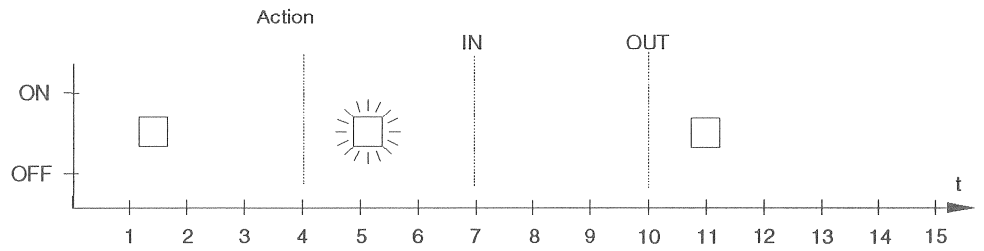

- TC running
- Replay in WRT ENA mode
- At "4" activate the key
- At "7" set active write (IN / SW WRT)
- At "10" deactivate (OUT / SW WRT).

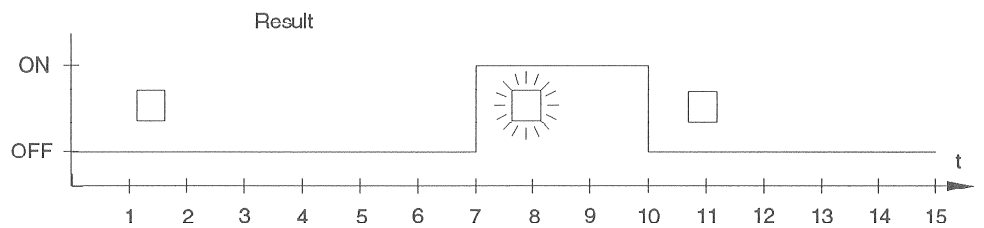

If no switch data exist the switch returns after OUT / SW WRT to the original position after the deactivation of active write mode.
 If the switch was off (start snapshot) it will jump back to this status even though the key was active before the deactivation of active write mode.

Example [5]: Activate / stop mix, if no switch data exist

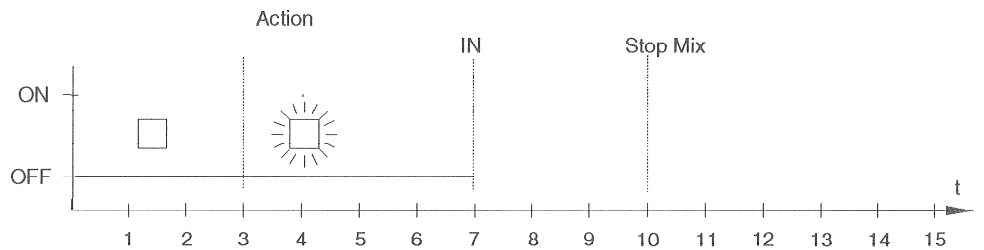

- TC running
- Replay in WRT ENA mode
- At "3" activate the key
- At "7" start active write (IN / SW WRT)
- At "10" stop mix.

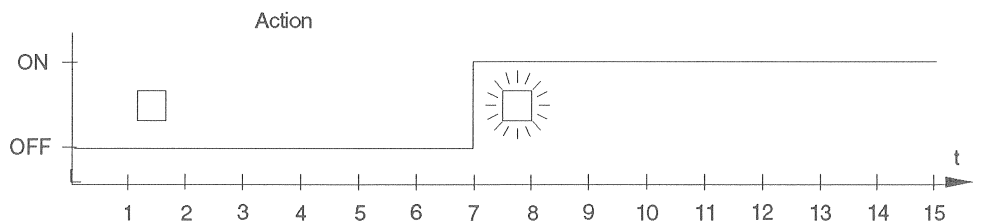

- After "7" the switch remains on.

5.3.3 UPDATE ENABLE Mode (UPD ENA)

Similar to the WRT mode the UPD mode is supplemented with the UPD ENA mode.

Before fader movements relative to the existing mix data can be recorded, the mixing console/channel must be switched to UPD ENA mode. No data are written in UPD ENA mode, but existing mix data are replayed.

The mixing console is now ready to be switched from UPD ENA mode (mixing console is "armed") to UPD mode, through specific operator action.

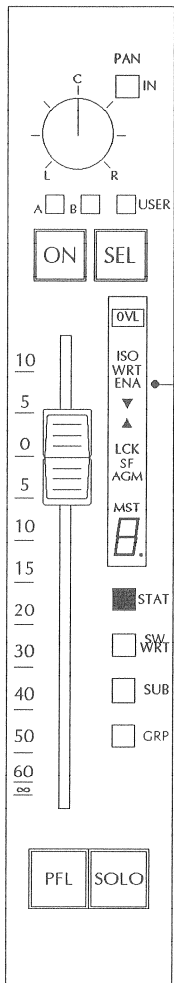

Indication of the UPD ENA mode:

- | | |
|--------------------------|----------------------------------|
| <u>Fader unit</u> | <u>ACU</u> |
| <u>ENA lamp is green</u> | <u>UPD lamp is on (switch)</u> |
| <u>STAT lamp is on</u> | <u>UPDATE lamp is on (fader)</u> |

- By pressing the UPDATE key in the fader section of the ACU, the faders and switches are set to UPD ENA mode (depending on the selected destination area, → see 5.2.3)
- By pressing the UPD key in the switch section of the ACU, the UPD ENA mode can be selected for the switches, independently of the selected fader mode (also depending on the selected destination area).

If the switches and faders have a different mode, the LCK lamp on the fader unit lights up.

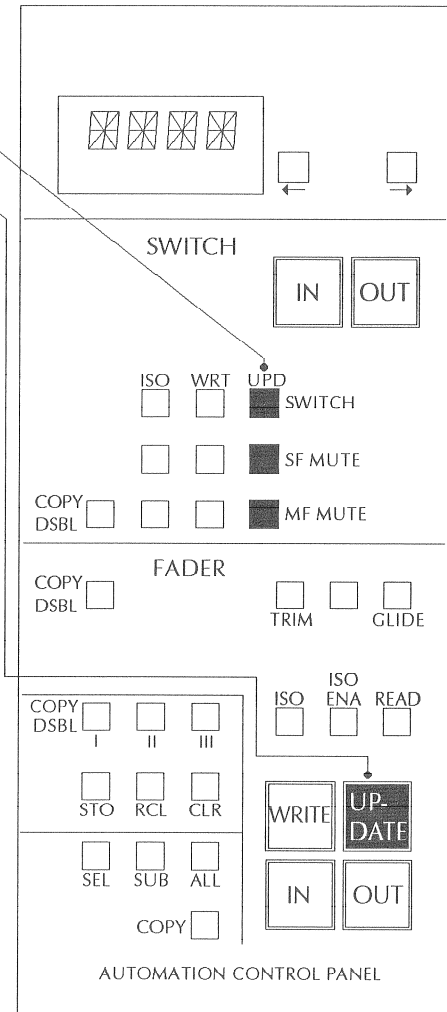

Transitions from UPD ENA mode to UPD mode (active write):

- Touch the fader knob *
- Press the STAT key on the fader unit (UPD ENA → UPD for faders)
- Press the SW WRT key on the fader unit (UPD ENA → UPD for switches)
- Press the IN key on the ACU (one key each for faders and switches).

To deactivate WRT mode (return to the UPD ENA mode):

- Press the STAT key on the fader unit (UPD → UPD ENA for faders)
- Press the SW WRT key on the fader unit (UPD → UPD ENA for switches)
- Press the IN key on the ACU (one key each for faders and switches).

* Applies only to motor faders, but not to manual faders.

5.3.4 UPDATE Mode (UPD)

When the mixing console is in UPD mode, fader movements relative to the existing movements are recorded.

If no mix data exist ("empty" mix), mix data are generated in the active UPDATE mode (same as in WRT mode).

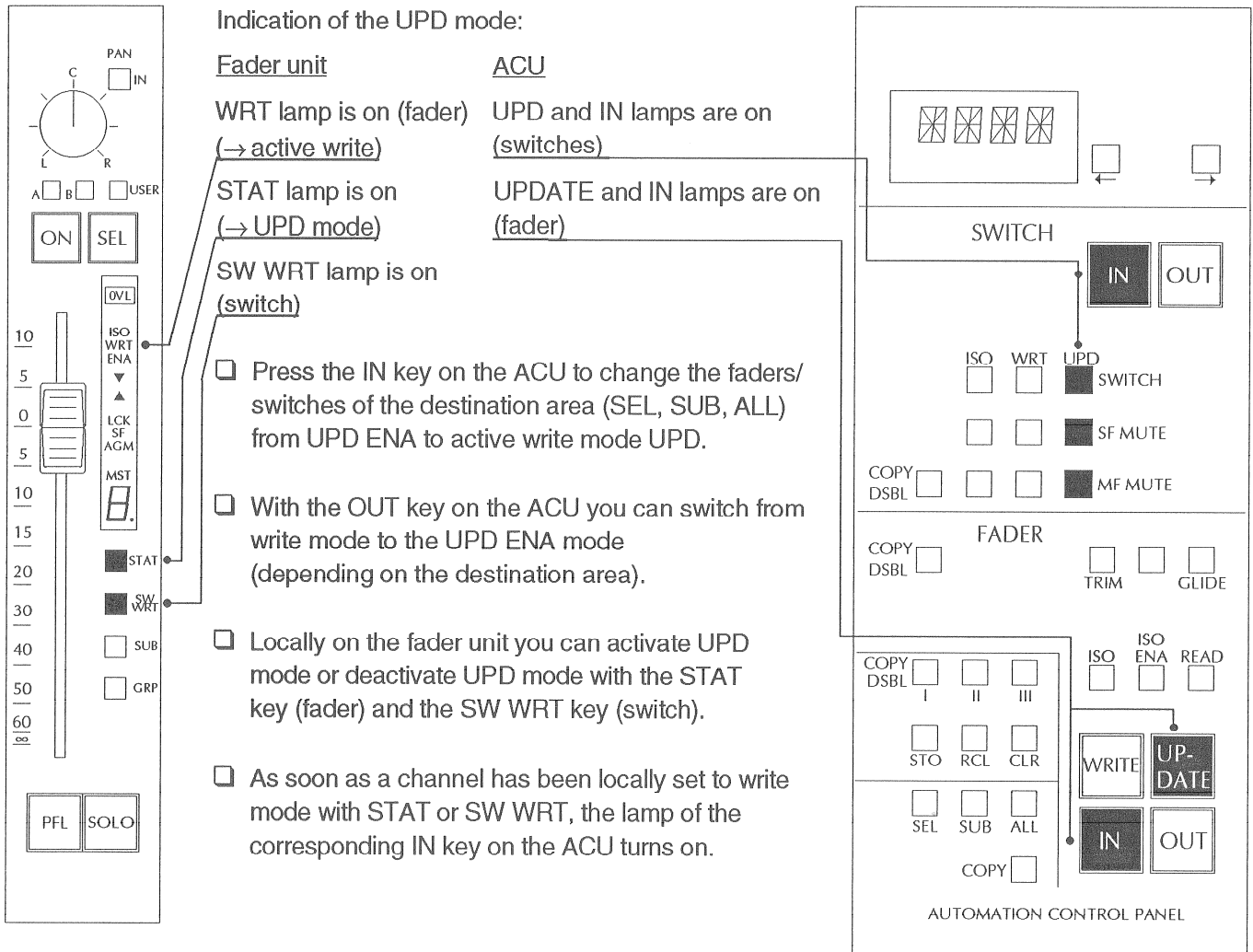

5.3.4.1 Examples for UPDATE Mode (Motor Faders)

Example [1]: Writing mix data ("empty" mix)

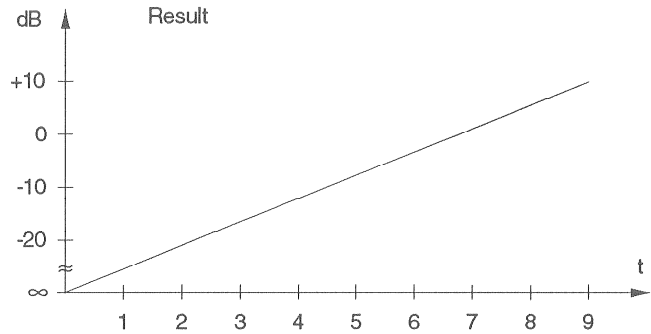
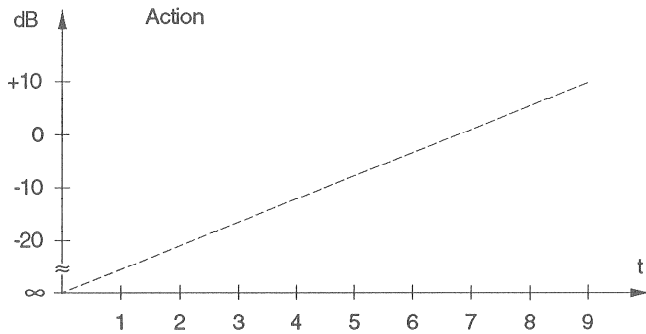

- UPD mode active (IN/STAT)
- Start TC
- Perform fader movement

- Replay the mix data
- Fader moves along

Caution: In STOP MIX, OUT, or STAT the fader remains in the current position (in example [1] at +10 dB).

Example [2]: Writing relative to existing mix data

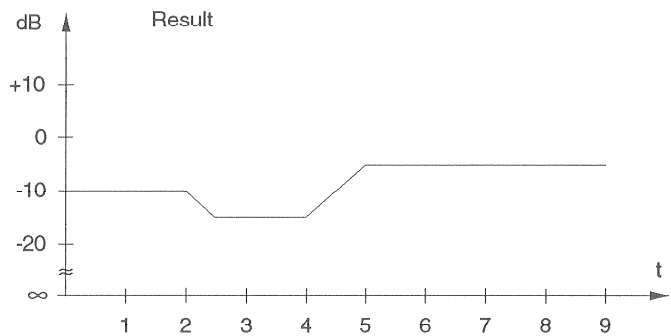
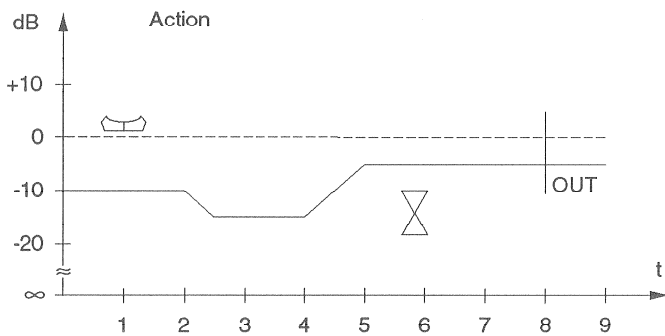

- UPD mode active (IN/STAT)
- Slide fader to 0 dB
- Start TC
- Fader remains in active UPD mode
- No fader movement
- No arrow LED is on
- At "8" OUT or STAT → Fader jumps to the position of the underlying mix data

- The mix has no change

Example [3]: Relative writing with activation during replay of the mix data.

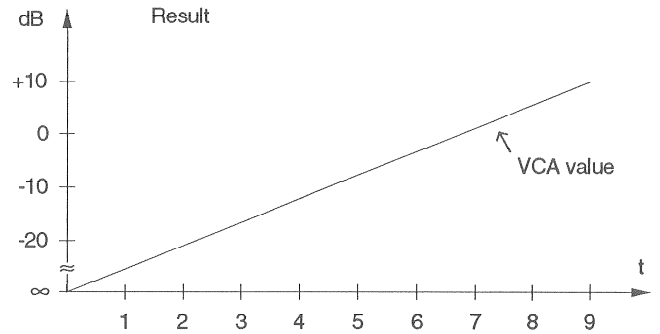
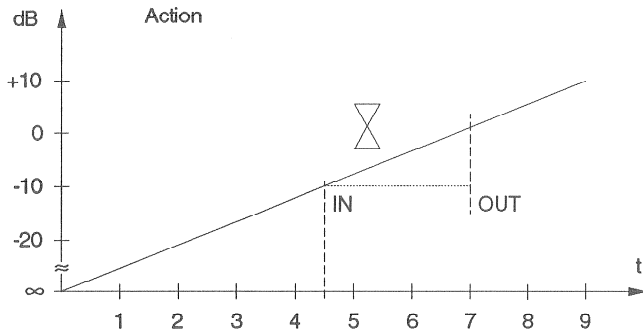

- Start TC
- Replay of the mix data (UPD ENA)
- Fader moves along
- At "4.5" start active update (Touch, STAT, IN)
- Fader stops (no arrow LEDs)
- Do not move the fader
- At "7" drop-out to UPD ENA
- Fader jumps to the position of the mix data and moves along

- Replay of the mix
- No changes* are produced because the fader was not moved during active UPDATE

Example [4]: Same as [3], but with fader movement during UPD

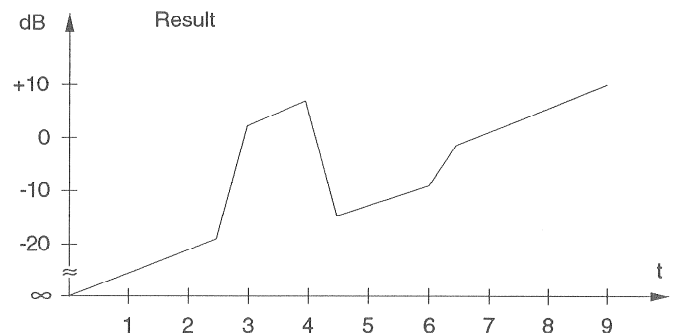
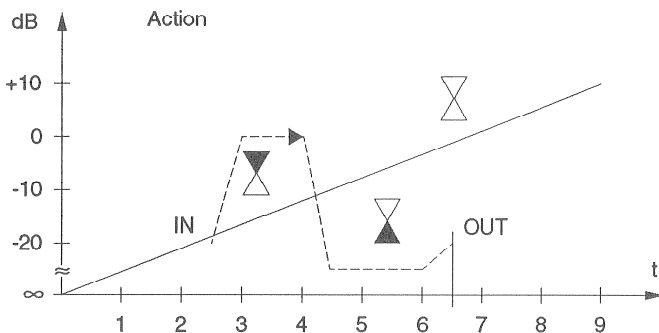

- Start TC, UPD ENA
- Mix data are replayed
- Fader moves along
- At "2.5" touch and pull the fader up to 0 dB
- At "4" slide the fader to -25 dB
- At "6" slide the fader in the direction indicated by the arrow LED until it goes off
- Deactivate with STAT or OUT ("6.5")

- The additional movements are integrated into the mix

Example [5]: Same example as [4], but with different motion sequences

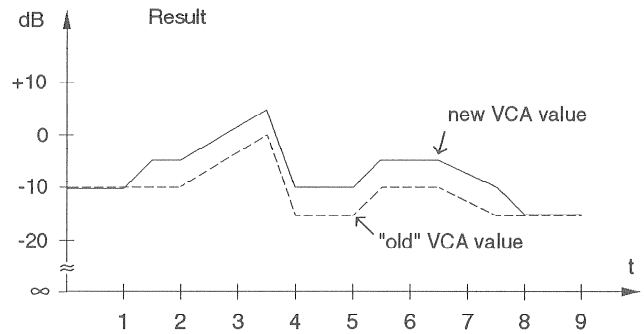
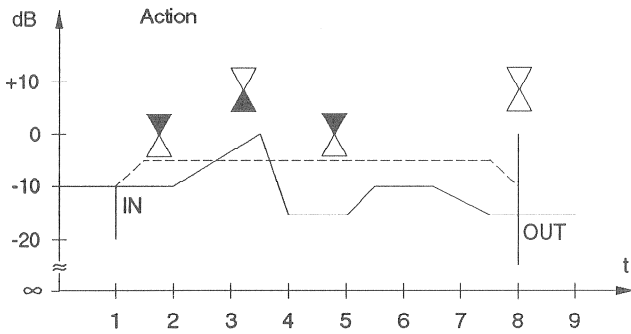

- At "1" activate UPD mode with Touch
- Slide the fader upward by 5 dB
- Leave the fader in this position until "7.5"
- Slide the fader in the direction of the arrow LED until it turns off
- Deactivate with OUT or STAT ("8")

- Replay the mix data
- All motion sequences are preserved but are now higher by 5 dB
- The dashed line illustrates the original VCA value

Example [6]: Same example as [5], except with GLIDE active

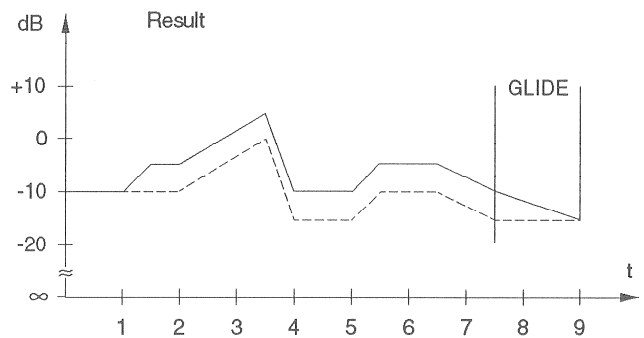
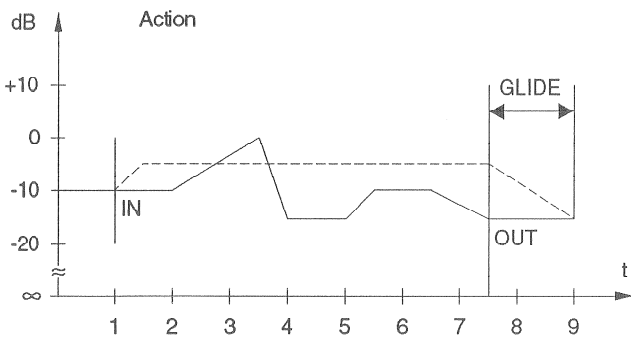

- GLIDE activated on ACU
- At "7.5" deactivate UPD mode (OUT or STAT)
- Fader performs a "Glide" movement until it is in line with the existing mix → at this moment the mode changes from UPD to UPD ENA

- Replay of the mix data

5.3.4.2 Examples for UPDATE Mode (Manual Faders)

Example [1]: Writing mix data ("empty" mix)

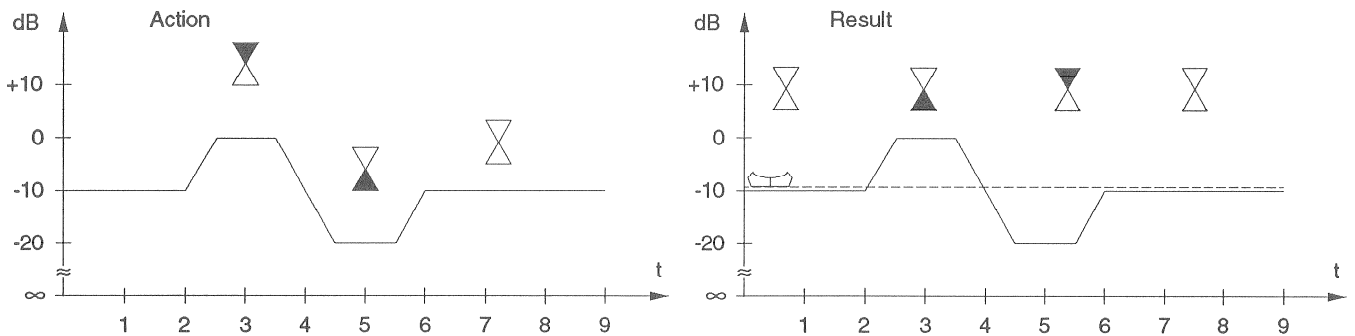

- UPD active (STAT, IN)
- Start TC
- Perform movements
- Arrow LEDs point to the initial position at the start of the mix.

- Replay the mix data
- Leave the fader in its present position
- Arrow LEDs point in the direction of the mix data

(Since no mix data exist for performing an UPDATE or relative write, the arrow LEDs indicate the offset to the initial position).

- Caution:**
- If the TC is not running or no mix data (e.g. "empty" mix) are transmitted, the VCA can be adjusted in UPD ENA mode by sliding the fader.
 - As soon as the TC is running or mix data are replayed by the VCA, the VCA can no longer be operated in UPD ENA mode! The VCA replays the mix data. The arrow LEDs point in the direction of the "underlying" mix data.
→ In this way it is possible to slide the fader to the corresponding position during the replay of mix data.

Example [2]: Write relative to existing mix data

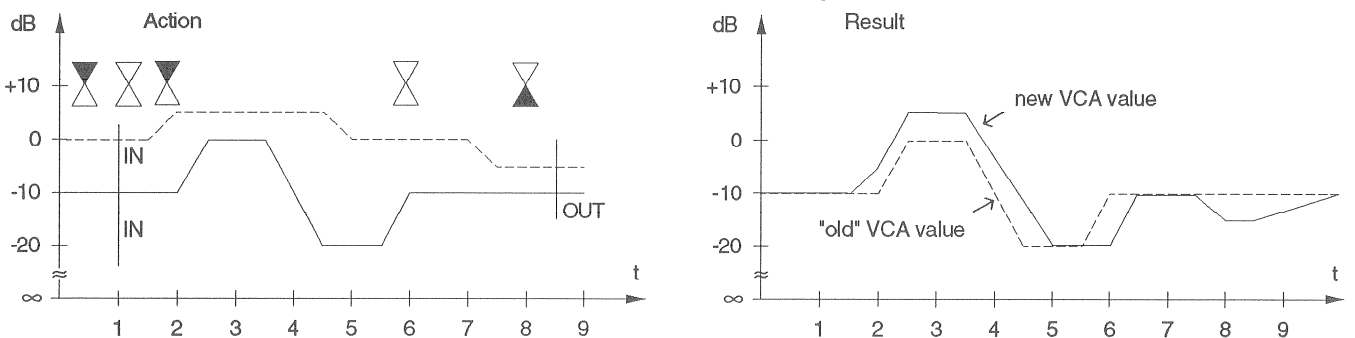

- (Activate GLIDE on the ACU)
- Fader is in 0 dB position
- Start TC
- During replay in UPD ENA mode the arrow LED indicates the offset to the actual VCA position (VCA is at -10 dB)
- When UPD is activated the arrow LED turns off (virtual match of the mechanical position of the fader with the VCA achieved, without jump)
- Slide fader to +5 dB; the active arrow LED now indicates zero offset
- At "4.5" slide the fader in the direction of the arrow LED until the LED turns off (the fader is now back at the 0 dB position)
- At "7" slide the fader to -5 dB
- When UPD mode is terminated with STAT/OUT, the VCA performs a ramp based on the set glide time until the "underlying" mix data are in line with the VCA value.
- At this moment the active mode changes to ENABLE mode.

5.3.4.3 Examples with Switches in UPDATE Mode

Example [1]: Write switch data ("empty" mix)

- UPD active (STAT or IN).

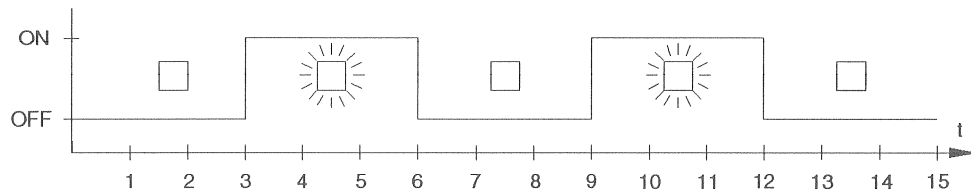

- In contrast to the active WRT mode the start snapshot is performed in UPD mode in the beginning when the mix start is reached.

Example [2]: Start snapshot

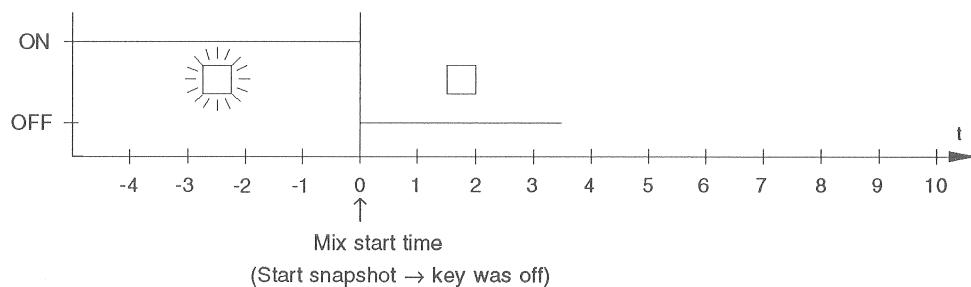

- Channel in active UPD mode.
- Key is illuminated.
- TC is replayed before the actual start of the mix.
- Key is illuminated until the lamp is turned off by the start snapshot (key off).

Example [3]: Write relative to existing switch data

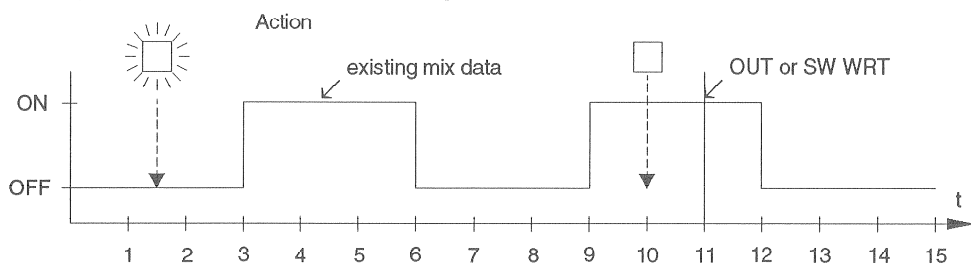

- Activate key at "1.5"
- Deactivate key at "10"
- At "11" terminate UPD mode → UPD-ENA (OUT or SW WRT).

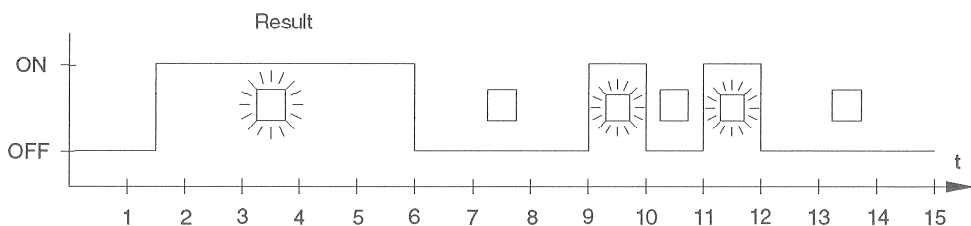

- During the setup the result appears already as during replay.
- Since transients are replayed in UPD mode, switch-off occurs, for example, at "6".
- At the transition UPD → UPD ENB the "underlying" mix data are replayed.

5.3.5 ISOLATE ENABLE Mode (ISO ENA)

The ISO ENA mode replays recorded mix data.

In ISO ENA mode mix data cannot be recorded or modified at any time. But during the replay of recorded mix data, changes to the replay parameters can be made.

It is possible, for example, to modify the VCA replay values of a channel during the replay of a mix by closing the fader - without influencing the recorded mix data.

During the next replay of the same mix the original mix data are replayed.

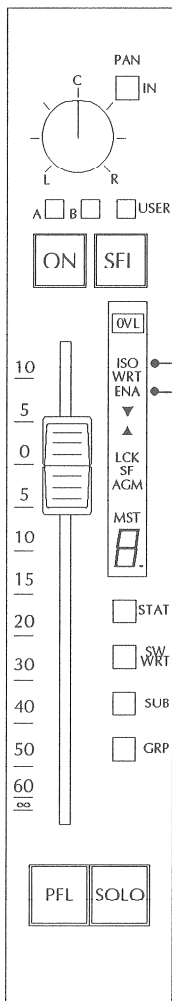

Indication of the ISO ENA mode:

Fader unit

ISO and ENA lamps are on (fader)

No indication for switch

By pressing the ISO ENA key in the fader section of the ACU, the switches and faders are set to ISO ENA mode, depending on the destination area.

Different modes can be selected for switches and faders (this is signaled by LCK on the fader unit).

The STAT key on the fader unit toggles between ISO and ISO ENA modes.

A changeover for switches is only possible from the ACU.

The IN and OUT keys on the ACU as well as SW WRT on the fader unit have no influence.

ACU

No key is illuminated (switch)

ISO ENA lamp is on (fader)

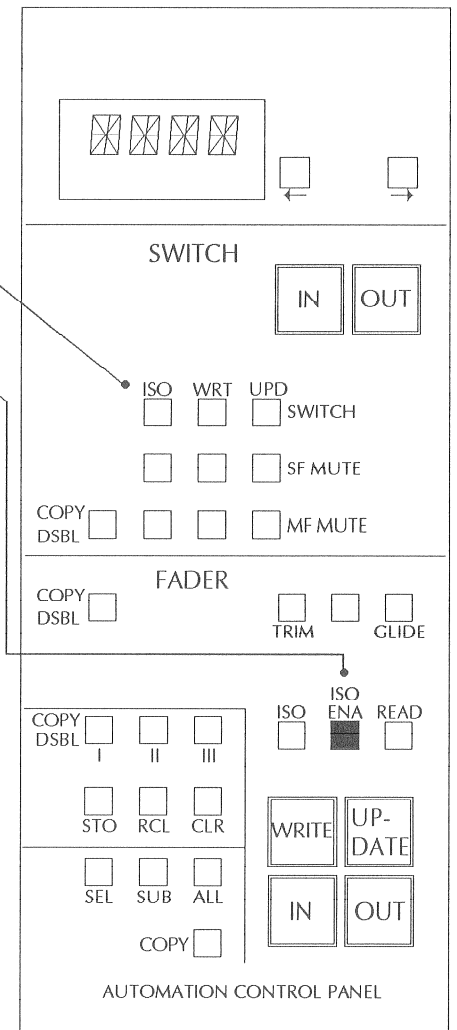

5.3.5.1 Examples for ISOLATE ENABLE Mode

Example [1]: Move the fader during the replay of mix data

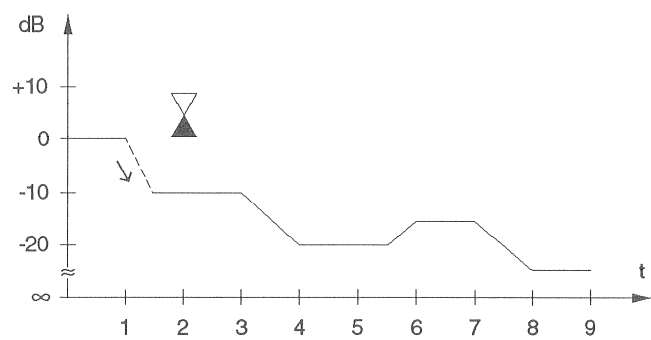
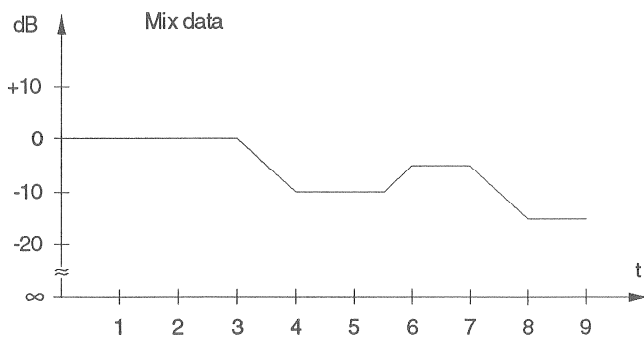

Fader replays the mix data

- At "1" slide the fader to -10 dB
- The arrow LED indicates an offset
- The mix data are replayed with the offset
- The fader performs the movement with the set offset.

When the mix data are used again the original values are replayed.

No mix data are changed or rewritten.

Manual faders behave exactly in the same way except that they do not duplicate the movement.

5.3.5.2 Switches in ISOLATE ENABLE Mode

Switches can be turned on or off as desired, but if any mix data exist, these will be executed.

The same applies when the switches are in UPD ENA or WRT ENA mode.

5.3.6 ISOLATE Mode (ISO)

No mix data are replayed in ISO mode. The mixing console behaves as if the automation is switched off.

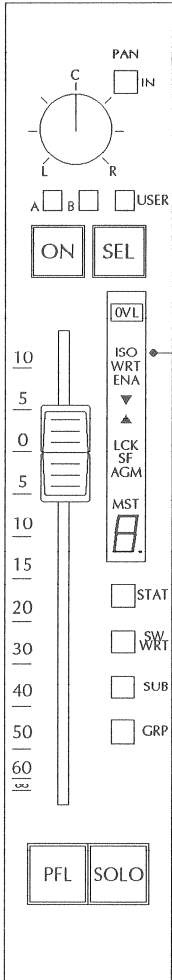

Indication of the ISO mode:

Fader unit

ISO lamp is on (fader)

No local indication for switches in ISO mode

When the ISO key in the fader section of the ACU is pressed, the faders and switches are set to ISOLATE mode.

Different modes can be set for switches and faders. In this case the LCK (lock) lamp on the fader unit is on.

With the STAT key on the fader unit you can toggle between ISO and ISO ENA (applies only to the faders).

Selection of the mode of the switches is possible only on the ACU.

The IN, OUT keys on the ACU as well as SW WRT on the fader unit have no function in ISOLATE mode.

ACU

ISO lamps are on (switch)

ISO lamp is on (fader)

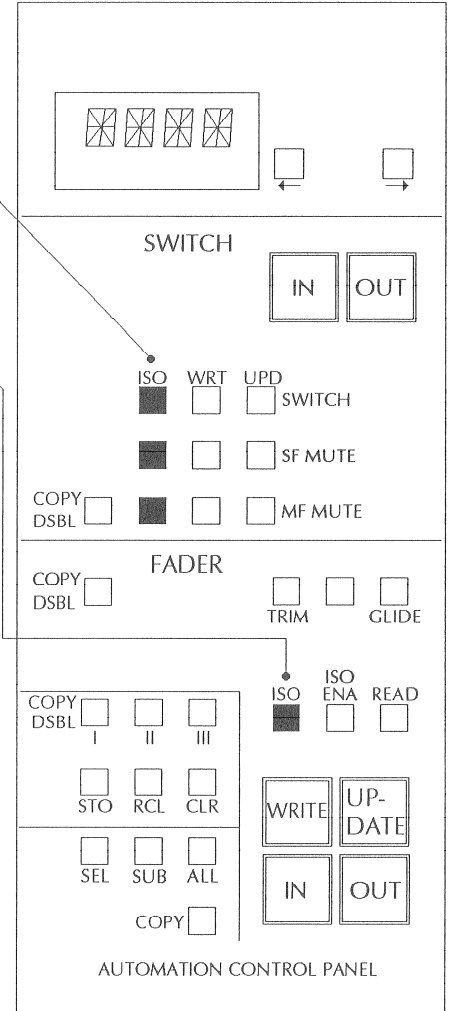

6 Cue List and Trigger / Signal Trigger

6.1 Cue List and Trigger

6.1.1 Setting the Cue Points

Cue points are set in accordance with the preselection in the mix options. They can also be set "on the fly" when time code is available.

There are different possibilities for setting cue points:

- With the **SET CUE** key on the keyboard
- Via the **Actions - Set Cue** menu option
- On the **Cue List and Trigger** page via the command button **Set Cue** (F7).

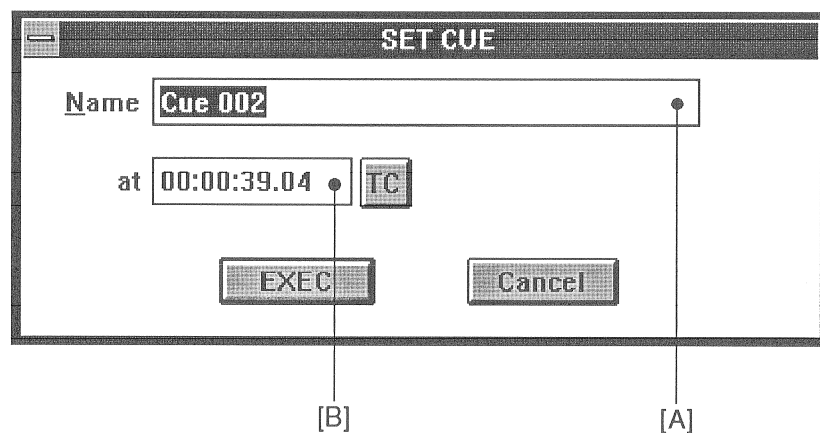

IMPORTANT: Before cue points can be set a mix must first be opened or created.

Mix Options When the check box *Enter name before creation* in the **MIX OPTIONS** dialog box has been selected, only the name [A] can be changed or accepted in the dialog box. The time code box [B] is inactive. Time code can be edited via **Edit Cue** (F8).

When the check box *Enter name after creation* has been selected, this function corresponds to the function above, except that the **Name** [A] and the **at** (time code) [B] boxes both are active in the **SET CUE** dialog box and that they both can be edited.

[F] **Set Cue** (F7). See 5.1.1

[G] **Edit Cue** (F8). See 5.1.3

[H] **Mix Memo** (F10). Opens the input field for entering a note to the current mix.

[I] **Mix Info** (F9). Opens the **MIX INFO** box.

6.1.3 Editing Cue Points

Before a cue point can be edited it must first be selected in the cue list. To open the **EDIT CUE** window press **Edit Cue** (F8). The following parameters can be set or modified here:

- Cue point name
- Cue time
- Linking of triggers from the signal trigger list to the selected cue point.

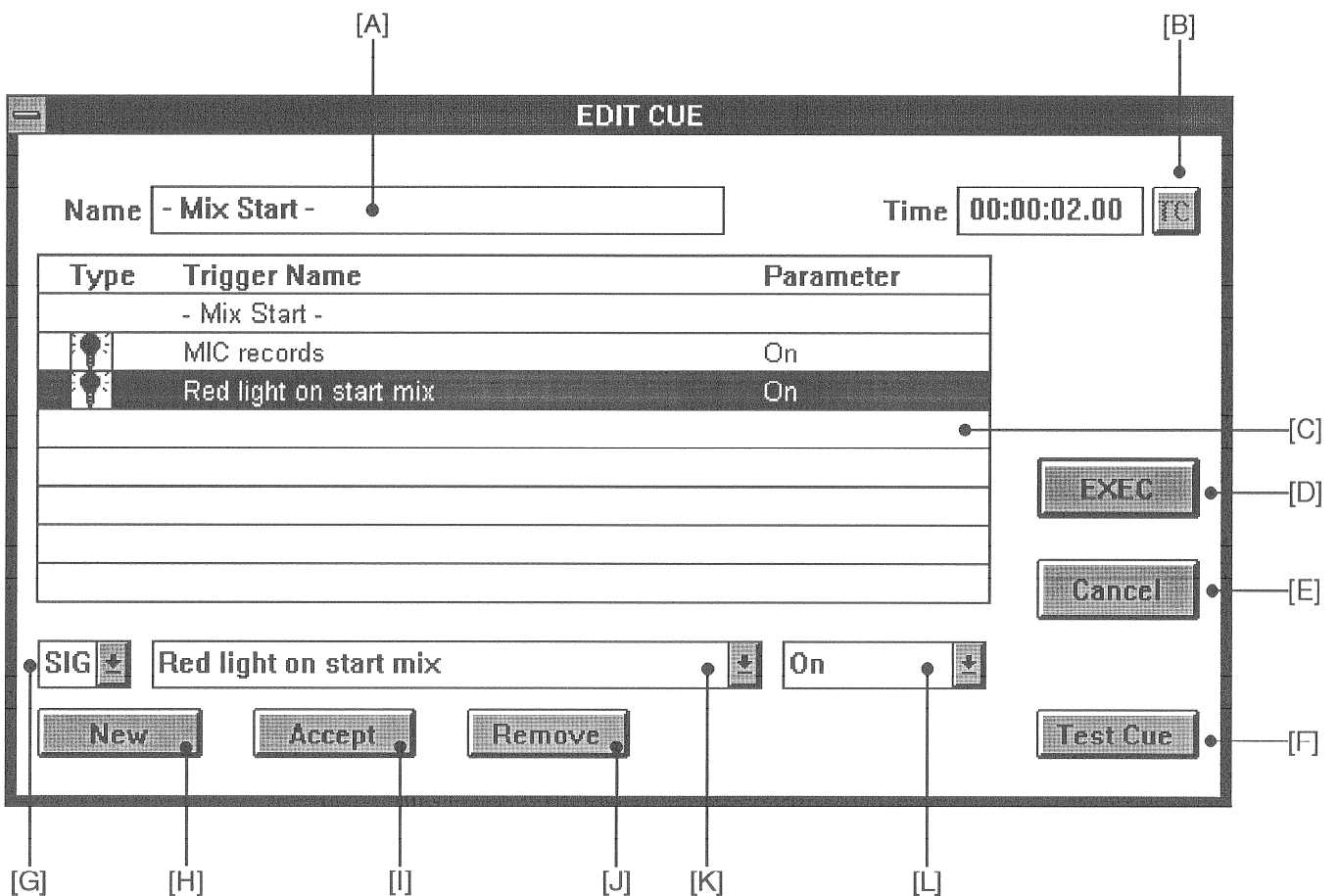

Any number of triggers can be linked to a cue point.

Edit cue point name Enter the desired name in the **Name** field [A]. To accept choose **EXEC** [D].

Edit time Click either into the **Time** code box and enter a new time, or click on the **TC** command button and open the time code editing window. To accept, choose **EXEC**[D].

Link triggers to cue point Precondition: Triggers must exist (see 5.2).

- [K] **1** Click on box [K] to choose a trigger from the existing triggers (and click on the desired trigger). This trigger now appears in box [K].
- [L] **2** You can now determine whether the desired trigger should be *On* or *Off* when the cue point is passed through. Choose with box [L]
- [G] **3** Per definition always a signal trigger (*SIG*) is specified because no others are available. No choice is required.
- [H] **4** When the *New* command button [H] is activated, the trigger is inserted into the trigger list [C]. For adding additional triggers to this cue point repeat steps 1...4.
- [I] With the *Accept* command button [I] you can use a trigger selected from the trigger list [C] by modifying the items [K] and [L] without creating a new trigger entry in the list (corresponds to the modification of a trigger).
- [J] Remove a trigger entry from the trigger list.
Click on the trigger to be removed and activate the *Remove* command button [J].
The entry is removed from the list.
- [F] With *Test Cue* [F] you can test the cue point with its triggers.
When [F] is activated by clicking, the red light is activated at the trigger entry *MIC records*. The passage through the cue point is simulated.
- [E], [D] With *EXEC* [D] you can accept all changes or reject them with *Cancel* [E].

6.2 Signal Trigger Page

Signal triggers, if linked to a cue point, can be initiated at the desired moment.

6.2.1 Establishing a Signal Trigger

From the *Cue List and Trigger* page you can switch to this page by pressing *Signal Trigger* (F2).

The screenshot shows the 'Signal Trigger' page in the Studer 990 Graphical Controller. The interface includes a menu bar (File, Edit, Notes, Config, Language, Actions, Pages, Help) and a main display area showing 'Signal Trigger' and 'ONLINE TRIG DYN 00:00:35.04'. Below this is a table with columns: Trigger Name, Type, Adr., Preroll, and Reset. The table contains three entries: 'FX on' (Fader Start, Adr. 1, Preroll 0), 'Piano solo' (Solo In Place, Adr. 1, Preroll 10), and 'Start mix' (Red Light, Adr. 1, Preroll 0). Each entry has a 'RESET' button with a checkmark. To the right of the table is a vertical label 'Signal Trigger List'. Below the table is an 'Input and Edit Area' with a text field containing 'Start mix', a dropdown menu showing 'Red Light', a numeric field with '1', another numeric field with '0', and a 'RESET' button. Below these are 'New', 'Accept', and 'Test' buttons. At the bottom is a grid of function keys F1-F10. Labels [A] through [N] point to various elements: [A] points to the title bar, [B] to the 'Type' column, [C] to the 'Adr.' column, [D] to the 'Preroll' column, [E] to the 'Reset' column, [F] to the F1 key, [G] to the 'Cue List' button, [H] to the 'Start mix' text field, [I] to the 'Accept' button, [J] to the 'Red Light' dropdown, [K] to the '1' numeric field, [L] to the '0' numeric field, [M] to the 'Test' button, and [N] to the F10 key.

[J] Click on the desired signal trigger, e.g. *Red Light*.
In the trigger list this entry is shown under *Type* [B].

[K] With the aid of this box you can choose the desired address (for example, fader start No. 14).
In the example *Red Light* a *1* is displayed, because only one studio monitor is configured (possible would be two studio monitors on a mixing console).
In the trigger list this entry is shown under *Adr.* [C].

[L] Here you can enter the desired preroll time in frames (1...9999).
See list under *Preroll* [D].

- [N] When this box is clicked on you can select between a "Reset with a cross" (X) or a "Reset with check mark" (✓).
"Reset with check mark" (✓) means that the trigger is reset when the time code falls before the cue point in a rewind operation.
"Reset with a cross" (X) means the opposite (see in the list under **Reset** [E]).
- [H] Clicking on this box sets a cursor. The desired name can now be entered (see in the list under **Trigger Name** [A]).
- [G] **New**; When you click on the **New** command button [G] the first created signal trigger is included in the list and is available on the **Cue List and Trigger** page for selection.
- [I] **Accept**; If an existing signal trigger is selected in the list, its parameters are displayed in the input zone (H, J, K, L, N). These parameters can now be modified. When **Accept** [I] is clicked on, the changes to the selected entry are accepted from the list without creating a new entry.
- [M] **Test**; Starts a test.
- [F] **Cue List** (F1). Click on this command button to switch to the **Cue List and Trigger** page.

7 OFFLINE Functions

The offline functions can only be operated when the automation operates in OFFLINE mode. They can be called up via the *Edit* menu accessible on the menu bar.

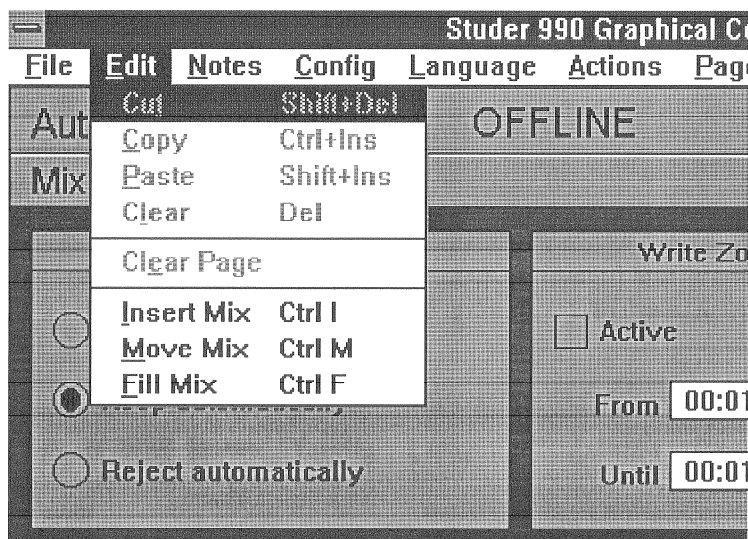

The functions can be accessed from the following pages:

- Automation Mode
- Timecode Setup
- Cue List and Trigger
- Signal List

7.1 Insert Mix

The *Insert Mix* function is used to replace a part of the current mix with a different mix (or part thereof) for the purpose of creating a new mix.

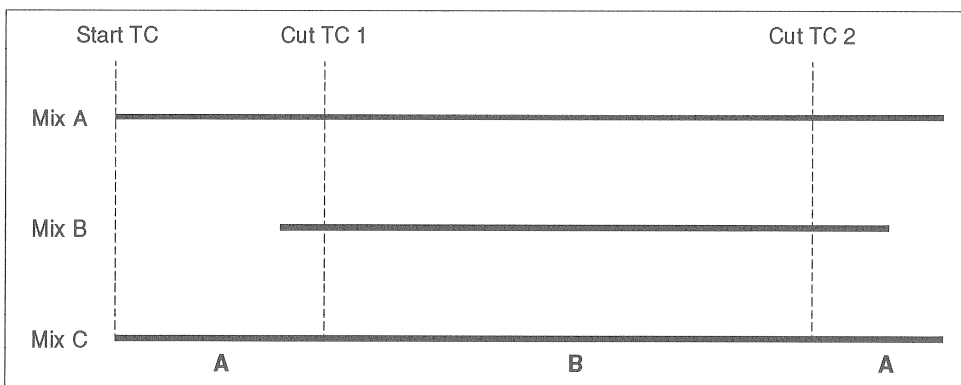

In this process neither mix is shifted relative to time. The start time and the start snapshot of the new mix ("Mix C") are taken from the original mix ("Mix A"). The first edit point "Cut TC 1" between the two mixes is normally the start of the second mix ("Mix B").

However, any other edit point within "Mix B" can be selected.

The start snapshot of "Mix B" and any automation data between the start of "Mix B" and edit point "Cut TC 2" are integrated in the data of the new mix. The second edit

point "Cut TC 2" is by default the end of "Mix B". "Cut TC 2" can also be edited but it must be greater than "Cut TC 1".

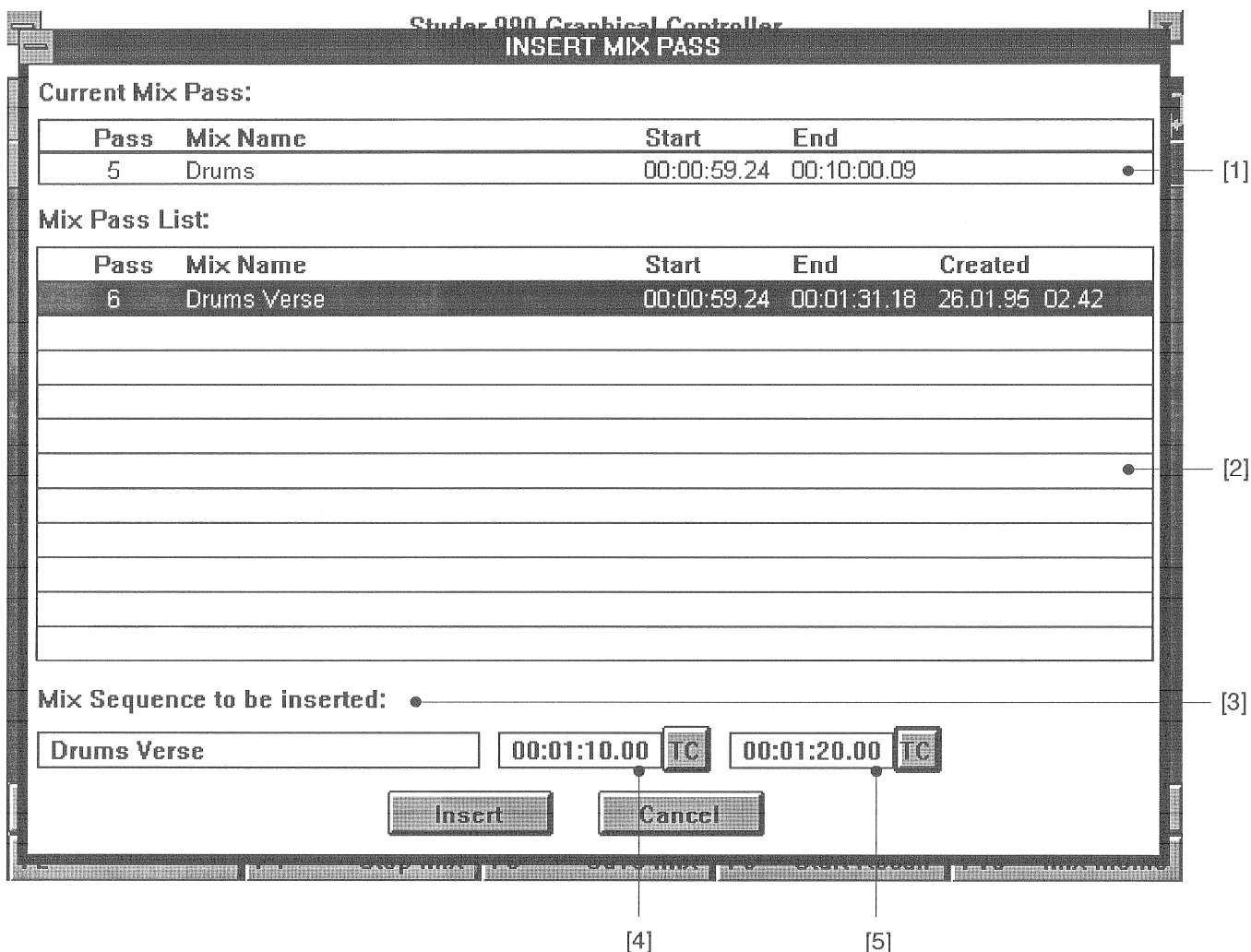

Caution: Start times can *not* be edited. The *Move Mix* function has to be used for this purpose!

- [1] **Current Mix Pass.** In this mix, mix passes from the **Mix Pass List** can be inserted.
- [2] **Mix Pass List.** This list contains all mix passes stored on the hard disk of the mixing console.
If a mix pass from the PC hard disk is to be inserted, it must first be loaded into this list.
- [3] The mix clicked on in the **Mix Pass List** is displayed as **Mix Sequence to be inserted**, together with its start and end value.
- [4] When this field is clicked on, an input box is opened in which the start edit time of the mix to be inserted can be edited.
- [5] In this field the end edit time of the mix to be inserted can be edited.

The **Insert Mix** function is initiated by clicking on the **Insert** command button. A new mix pass is generated which becomes the current mix.

7.2 Move Mix

With **Move Mix** a mix can be shifted along the time axis. The user defines the start time of the new mix. In this process a new mix pass with a changed start time is created. The original mix remains unchanged.

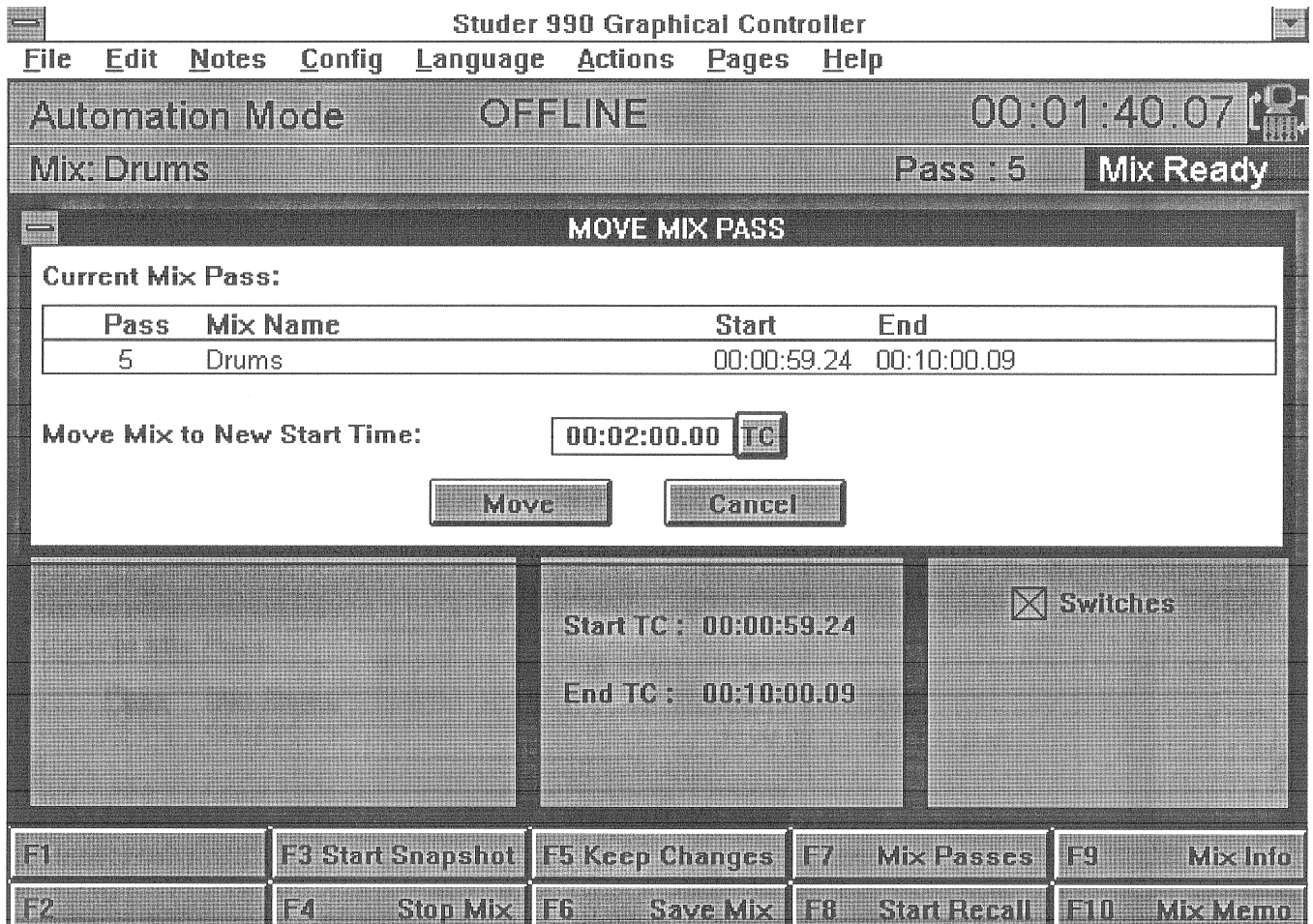

- [1] Before a mix can be moved it must be loaded from the **Mix Pass List**. It then becomes the current mix pass.
- [2] The current mix can now be moved by changing the start time.
- [3] To initiate the function, click on the **Move** command button; a new mix pass is created.

7.3 *Fill Mix*

This function is intended for long mixes in which the fader settings remain unchanged over a longer period of time. In such a case it is possible to record only sections with level changes (fade-in/out) and to leave the rest of the mix empty. The gaps can subsequently be filled with constant levels by using the *Fill Mix* function.

Gaps are filled only with the mix data right before the gap; as soon as mix data are present, they will be neither modified nor overwritten.

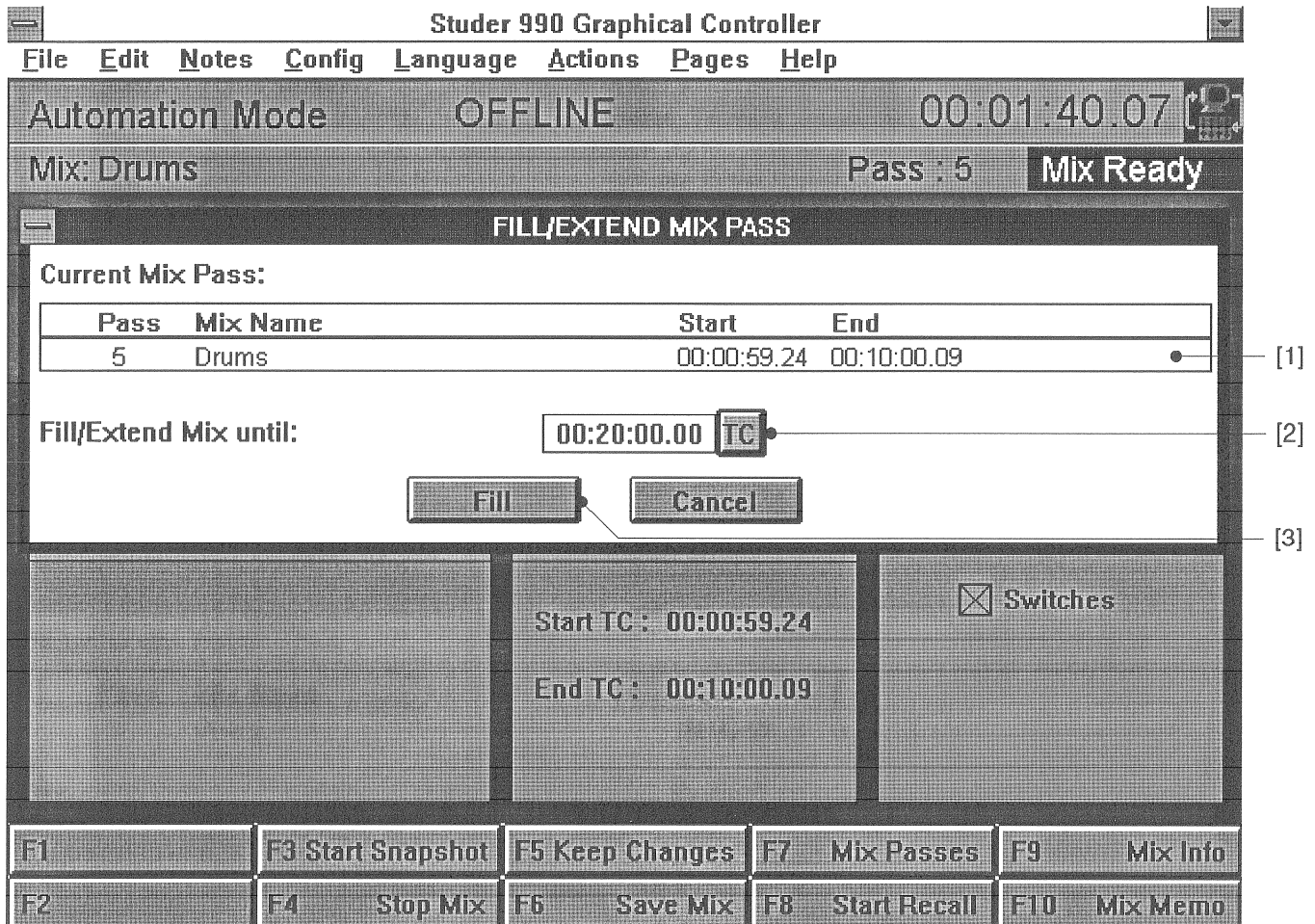

- [1] Before a mix can be filled it must be loaded from the *Mix Pass List*.
- [2] It is possible to prolong the current mix by editing the mix end time. The mix is then filled with the last fader data up to the end of the mix.
- [3] This function is initiated by clicking on the *Fill* command button; a new mix pass is created under the same name.

Example: Mix pass with different mix data and gaps; after the *Fill Mix* function the gaps are filled.

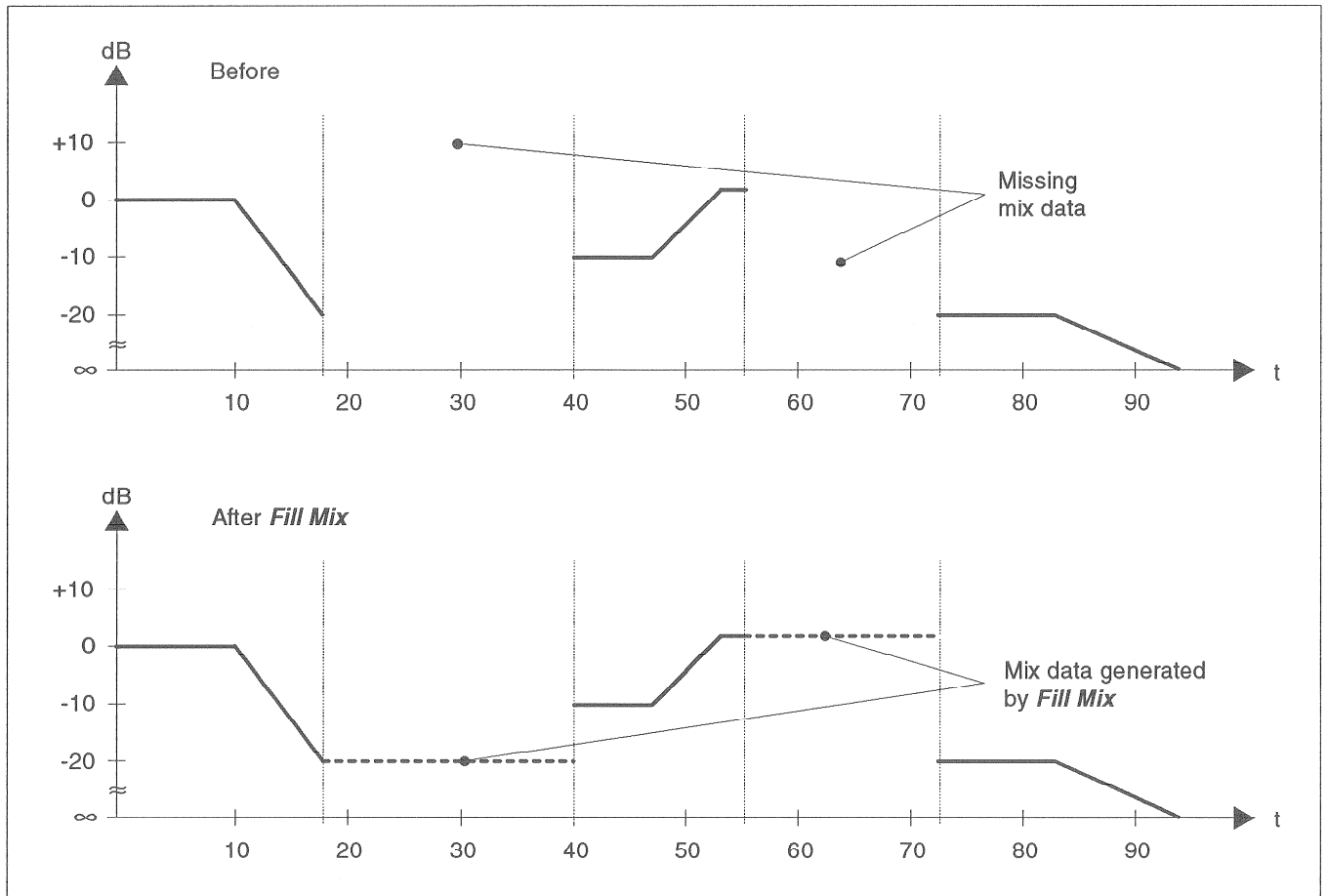

At the transitions, jumps can occur - depending on the existing mix data.

