

---

# STUDER A820 MCH MKII

## Operating and Service Instructions



Prepared and edited by STUDER INTERNATIONAL (a division of STUDER REVOX AG) TECHNICAL DOCUMENTATION  
Althardstrasse 10, CH-8105 Regensdorf-Zürich

We reserve the right to make alterations.

Copyright by STUDER REVOX AG

printed in Switzerland



Order No.: 10.27.0666 (Ed. 07.92)

STUDER is a registered trade mark of STUDER REVOX AG Regensdorf

STUDER ist ein eingetragenes Warenzeichen der STUDER REVOX AG Regensdorf

|          |   |
|----------|---|
| <b>1</b> | <b>General Information</b><br><br>Quick-Reference Description<br>Standard Versions<br>Options<br>Accessories<br>Maintenance Hints for the Service Personnel<br>Technical Data<br>Standard Calibration Data  |
| <b>2</b> | <b>Installation, Operating</b><br><br>Unpacking and Testing<br>Installation Site<br>Connections<br>Operating Instructions<br>Operation<br>Soft Keys, Status Tree Diagram<br>Degraded Operation<br>Operation with Serial Interface<br>Care Instructions  |
| <b>3</b> | <b>Power Supply, Tape Deck Control</b><br><br>Checks, Adjustments<br>Circuit Descriptions   |
| <b>4</b> | <b>Audio</b><br><br>Calibration<br>Manual Reproduce Adjustments<br>Manual Record Adjustments<br>Manual Sync Reproduction Adjustments<br>Automatic Audio and Dolby Adjustments<br>Time Code Recording<br>External Storage of the Audio Parameters<br>Programming the Operating Parameters<br>Reproduce Preamplifier 8 CH<br>Time Code Line Amplifier |

## A Safety Information

|   |  |
|---|--|
| <p><b>CAUTION</b><br/>RISK OF ELECTRIC SHOCK<br/>DO NOT OPEN</p> <p><b>ATTENTION</b><br/>RISQUE DE CHOC ELECTRIQUE<br/>NE PAS OUVRIr</p> <p><b>ACHTUNG</b><br/>GEFAHR: ELEKTRISCHER SCHLAG<br/>NICHT ÖFFNEN</p> | <p>To reduce the risk of electric shock, do not remove covers. No user-serviceable parts inside. Refer servicing to qualified service personnel (i.e., persons having appropriate technical training and experience necessary to be aware of hazards to which they are exposed in performing a repair action, and of measures to minimize the danger of themselves).</p>   |
|    | <p>This symbol alerts the user to the presence of un-insulated <i>dangerous voltage</i> within the equipment that may be of sufficient magnitude to constitute a risk of electric shock to a person.</p>   |
|    | <p>This symbol alerts the user to <i>important instructions</i> for operating and maintenance in this documentation.</p>   |
| <p><b>CLASS I</b><br/>LED PRODUCT</p> <p><b>CLASS I</b><br/>LASER PRODUCT</p>   | <p>Assemblies or sub-assemblies of this product can contain opto-electronic devices. As long as these devices comply with Class I of laser or LED products according to EN 60825-1:1994, they will not be expressly marked on the product. If a special design should be covered by a higher class of this standard, the device concerned will be marked directly on the assembly or sub-assembly in accordance with the above standard.</p> |

### A1 First Aid

#### In Case of Electric Shock:

Separate the person as quickly as possible from the electric power source:

- By switching off the equipment,
- By unplugging or disconnecting the mains cable, or
- By pushing the person away from the power source, using dry, insulating material (such as wood or plastic).
- After having suffered an electric shock, *always* consult a doctor.



**Warning!** *Do not touch the person or his clothing before the power is turned off, otherwise you stand the risk of suffering an electric shock as well!*

#### If the Person is Unconscious:

- Lay the person down
- Turn him to one side
- Check the pulse
- Reanimate the person if respiration is poor
- *Call for a doctor immediately.*

---

## **B General Installation Instructions**

---

Please consider besides these general instructions also any product-specific instructions in the “Installation” chapter of this manual.

### **B1 Unpacking**

---

Check the equipment for any transport damage. If the unit is mechanically damaged, if liquids have been spilled or if objects have fallen into the unit, *it must not be connected to the AC power outlet, or it must be immediately disconnected by unplugging the power cable*. Repair must only be performed by trained personnel in accordance with the applicable regulations.

### **B2 Installation Site**

---

Install the unit in a place where the following conditions are met:

- The temperature and the relative humidity of the environment must be within the specified limits during operation of the unit. Relevant values are the ones at the air inlets of the unit.
- Condensation must be avoided. If the unit is installed in a location with large variation of ambient temperature (e.g. in an OB-van), appropriate precautions must be taken before and after operation (for details on this subject, refer to Appendix 1).
- Unobstructed air flow is essential for proper operation. Air vents of the unit are a functional part of the design and must not be blocked in any way during operation (e.g. by objects placed upon them, placement of the unit on a soft surface, or installation of the unit within a rack or piece of furniture).
- The unit must not be heated up by external sources of heat radiation (sunlight, spot lights).

### **B3 Earthing and Power Supply**

---

Earthing of units with mains supply (class I equipment) is performed via the protective earth (PE) conductor integrated in the mains cable. Units with battery operation (< 60 V, class III equipment) must be earthed separately.

Earthing the unit is one of the measures for protection against electrical shock hazard (dangerous body currents). Hazardous voltage may not only be caused by a defective power supply insulation, but may also be introduced by the connected audio or control cables.

If the unit is installed with one or several external connections, its earthing must be provided during operation as well as while the unit is not operated. If the earthing connection can be interrupted, for example, by unplugging the mains plug of an external power supply unit, an additional, permanent earthing connection must be installed using the provided earth terminal.

Avoid ground loops (hum loops) by keeping the loop surface as small as possible (by consequently guiding the earth conductors in a narrow, parallel way), and reduce the noise current flowing through the loop by inserting an additional impedance (common-mode choke).

**Class I Equipment (Mains Operation)**

Should the equipment be delivered without a matching mains cable, the latter has to be prepared by a trained person using the attached female plug (IEC320/C13 or IEC320/C19) with respect to the applicable regulations in your country.

Before connecting the equipment to the AC power outlet, check that the local line voltage matches the equipment rating (voltage, frequency) within the admissible tolerance. The equipment fuses must be rated in accordance with the specifications on the equipment.

Equipment supplied with a 3-pole appliance inlet (protection conforming to class I equipment) *must* be connected to a 3-pole AC power outlet so that the equipment cabinet is connected to the protective earth.

For information on mains cable strain relief please refer to Appendix 2.

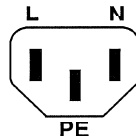
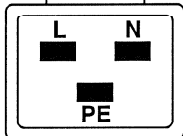
| Female Plugs (IEC320), Front-Side View:  |                       |                               |  |  |  |
|--|-----------------------|-------------------------------|--|--|--|
| <br>IEC 320 / C13 |                       |                               | <br>IEC 320 / C19 |  |  |
| European Standard (CENELEC)  |                       | North American Standard (NAS) |  |  |  |
| Brown  | L (Live)              | Black                         |  |  |  |
| Blue   | N (Neutral)           | White                         |  |  |  |
| Green/Yellow   | PE (Protective Earth) | Green (or Green/Yellow)       |  |  |  |

**Class III Equipment (Battery Operation up to 60 V<sub>DC</sub>)**

Equipment of this protection class must be earthed using the provided earth terminal, if one or more external signals are connected to the unit (see explanation at the beginning of this paragraph).

**B4 Electromagnetic Compatibility (EMC)**

The unit conforms to the protection requirements relevant to electromagnetic phenomena that are listed in guidelines 89/336/EC and FCC, part 15.

- The electromagnetic interference generated by the unit is limited in such a way that other equipment and systems can be operated normally.
- The unit is adequately protected against electromagnetic interference so that it can operate properly.

The unit has been tested and conforms to the EMC standards of the specified electromagnetic environment, as listed in the following declaration. The limits of these standards ensure protection of the environment and corresponding noise immunity of the equipment with appropriate probability. However, a professional installation and integration within the system are imperative prerequisites for operation without EMC problems.

For this purpose, the following measures must be followed:

- Install the equipment in accordance with the operating instructions. Use the supplied accessories.
- In the system and in the vicinity where the equipment is installed, use only components (systems, equipment) that also fulfill the EMC standards for the given environment.
- Use a system grounding concept that satisfies the safety requirements (class I equipment must be connected with a protective ground conduc-

tor) and that also takes into consideration the EMC requirements. When deciding between radial, surface, or combined grounding, the advantages and disadvantages should be carefully evaluated in each case.

- Use shielded cables where shielding is specified. The connection of the shield to the corresponding connector terminal or housing should have a large surface and be corrosion-proof. Please note that a cable shield connected only single-ended can act as a transmitting or receiving antenna within the corresponding frequency range.
- Avoid ground loops or reduce their adverse effects by keeping the loop surface as small as possible, and reduce the noise current flowing through the loop by inserting an additional impedance (e.g. common-mode choke).
- Reduce electrostatic discharge (ESD) of persons by installing an appropriate floor covering (e.g. a carpet with permanent electrostatic filaments) and by keeping the relative humidity above 30%. Further measures (e.g. conducting floor) are usually unnecessary and only effective if used together with corresponding personal equipment.
- When using equipment with touch-sensitive operator controls, please take care that the surrounding building structure allows for sufficient capacitive coupling of the operator. This coupling can be improved by an additional, conducting surface in the operator's area, connected to the equipment housing (e.g. metal foil underneath the floor covering, carpet with conductive backing).

## C Maintenance

All air vents and openings for operating elements (faders, rotary knobs) must be checked on a regular basis, and cleaned in case of dust accumulation. For cleaning, a soft paint-brush or a vacuum cleaner is recommended. Cleaning the surfaces of the unit is performed with a soft, dry cloth or a soft brush.

Persistent contamination can be treated with a cloth that is slightly humidified with a mild cleaning solution (soap-suds).

For cleaning display windows, commercially available computer/TV screen cleaners are suited. Use only a slightly damp (never wet) cloth.

*Never use any solvents for cleaning the exterior of the unit! Liquids must never be sprayed or poured on directly!*

For equipment-specific maintenance information please refer to the corresponding chapter in the Operating and Service Instructions manuals.

## D Electrostatic Discharge during Maintenance and Repair

### Caution:



Observe the precautions for handling devices sensitive to electrostatic discharge!

Many semiconductor components are sensitive to electrostatic discharge (ESD). The life-span of assemblies containing such components can be drastically reduced by improper handling during maintenance and repair work. Please observe the following rules when handling ESD sensitive components:

- ESD sensitive components should only be stored and transported in the packing material specifically provided for this purpose.
- *When performing a repair by replacing complete assemblies, the removed assembly must be sent back to the supplier in the same packing*

*material in which the replacement assembly was shipped. If this should not be the case, any claim for a possible refund will be null and void.*

- Unpacked ESD sensitive components should only be handled in ESD protected areas (EPA, e.g. area for field service, repair or service bench) and only be touched by persons who wear a wristlet that is connected to the ground potential of the repair or service bench by a series resistor. The equipment to be repaired or serviced as well as all tools and electrically semi-conducting work, storage, and floor mats should also be connected to this ground potential.
- The terminals of ESD sensitive components must not come in uncontrolled contact with electrostatically chargeable (voltage puncture) or metallic surfaces (discharge shock hazard).
- To prevent undefined transient stress of the components and possible damage due to inadmissible voltages or compensation currents, electrical connections should only be established or separated when the equipment is switched off and after any capacitor charges have decayed.

## **E Repair**

---

Removal of housing parts, shields, etc. exposes energized parts. For this reason the following precautions must be observed:

- Maintenance may only be performed by trained personnel in accordance with the applicable regulations.
- The equipment must be switched off and disconnected from the AC power outlet before any housing parts are removed.
- Even if the equipment is disconnected from the power outlet, parts with hazardous charges (e.g. capacitors, picture tubes) must not be touched until they have been properly discharged. Do not touch hot components (power semiconductors, heat sinks, etc.) before they have cooled off.
- If maintenance is performed on a unit that is opened and switched on, no un-insulated circuit components and metallic semiconductor housings must be touched, neither with your bare hands nor with un-insulated tools.

Certain components pose additional hazards:

- *Explosion hazard* from lithium batteries, electrolytic capacitors and power semiconductors (watch the component's polarity. Do not short battery terminals. Replace batteries only by the same type).
- *Implosion hazard* from evacuated display units.
- *Radiation hazard* from laser units (non-ionizing), picture tubes (ionizing).
- *Caustic effect* of display units (LCD) and components containing liquid electrolyte.

*Such components should only be handled by trained personnel who are properly protected (e.g. safety goggles, gloves).*

**E1 SMD Components**

Studer has no commercially available SMD components in stock for service purposes. For repair, the corresponding devices have to be purchased locally. The specifications of special components can be found in the service manual.

SMD components should only be replaced by skilled specialists using appropriate tools. No warranty claims will be accepted for circuit boards that have been damaged. Proper and improper SMD soldering joints are illustrated below.

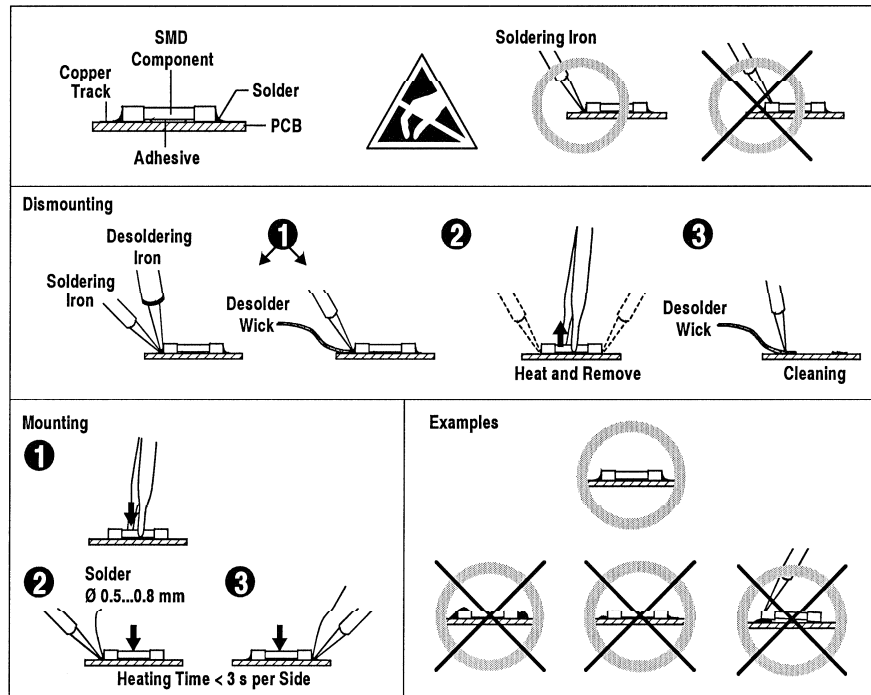

**F Disposal**

**Disposal of Packing Materials**

The packing materials have been selected with environmental and disposal issues in mind. All packing material can be recycled. Recycling packing saves raw materials and reduces the volume of waste.

If you need to dispose of the transport packing materials, please try to use recyclable means.

**Disposal of Used Equipment**

Used equipment contains valuable raw materials as well as materials that must be disposed of professionally. Please return your used equipment via an authorized specialist dealer or via the public waste disposal system, ensuring any material that can be recycled is.

Please take care that your used equipment cannot be abused. To avoid abuse, delete sensitive data from any data storage media. After having disconnected your used equipment from the mains supply, make sure that the mains connector and the mains cable are made useless.



---

**G      Declarations of Conformity**

---

**G1      Class A Equipment - FCC Notice**

---

This equipment has been tested and found to comply with the limits for a Class A digital device, pursuant to Part 15 of the FCC Rules. These limits are designed to provide a reasonable protection against harmful interference when the equipment is operated in a commercial environment. This equipment generates, uses, and can radiate radio frequency energy and, if not installed and used in accordance with the instruction manual, may cause harmful interference to radio communications. Operation of this equipment in a residential area is likely to cause harmful interference, in which case the user will be required to correct the interference at his own expense.

*Caution:* Any changes or modifications not expressly approved by the manufacturer could void the user's authority to operate the equipment. Also refer to relevant information in this manual.

---

**G2      CE Declaration of Conformity**

---

We,

**Studer Professional Audio GmbH,  
CH-8105 Regensdorf,**

declare under our sole responsibility that the product

**Studer A820 MCH, Professional Multi-Channel Tape Recorder**

to which this declaration relates, according to following regulations of EU directives and amendments

- Low Voltage (LVD):  
73/23/EEC + 93/68/EEC
- Electromagnetic Compatibility (EMC):  
89/336/EEC + 92/31/EEC + 93/68/EEC

is in conformity with the standards or normative documents listed in the "Technical Data" (Safety and EMC Standards) chapter in this manual.

Regensdorf, June 16, 1995



B. Hochstrasser, President



P. Fiala, Manager QA

## Appendix 1: Air Temperature and Humidity

### General

Normal operation of the unit or system is warranted under the following ambient conditions defined by *EN 60721-3-3, set IE32, value 3K3*.

This standard consists of an extensive catalogue of parameters, the most important of which are: ambient temperature +5...+40 °C, relative humidity 5...85% (i.e., no formation of condensation or ice); absolute humidity 1...25 g/m<sup>3</sup>; rate of temperature change < 0.5 °C/min. These parameters are dealt with in the following paragraphs.

Under these conditions the unit or system starts and works without any problem. Beyond these specifications, possible problems are described in the following paragraphs.

### Ambient Temperature

Units and systems by Studer are generally designed for an ambient temperature range (i.e. temperature of the incoming air) of +5...+40 °C. When rack mounting the units, the intended air flow and herewith adequate cooling must be provided. The following facts must be considered:

- The admissible ambient temperature range for operation of the semiconductor components is 0 °C to +70 °C (commercial temperature range for operation).
- The air flow through the installation must provide that the outgoing air is always cooler than 70 °C.
- Average heat increase of the cooling air shall be about 20 K, allowing for an additional maximum 10 K increase at the hot components.
- In order to dissipate 1 kW with this admissible average heat increase, an air flow of 2.65 m<sup>3</sup>/min is required.

**Example:** A rack dissipating  $P = 800\text{ W}$  requires an air flow of  $0.8 * 2.65\text{ m}^3/\text{min}$  which corresponds to  $2.12\text{ m}^3/\text{min}$ .

- If the cooling function of the installation must be monitored (e.g. for fan failure or illumination with spot lamps), the outgoing air temperature must be measured directly above the modules at several places within the rack. The trigger temperature of the sensors should be 65 to 70 °C.

### Frost and Dew

The unsealed system parts (connector areas and semiconductor pins) allow for a minute formation of ice or frost. However, formation of dew visible with the naked eye will already lead to malfunctions. In practice, reliable operation can be expected in a temperature range above -15 °C, if the following general rule is considered for putting the cold system into operation:

If the air within the system is cooled down, the relative humidity rises. If it reaches 100%, condensation will arise, usually in the boundary layer between the air and a cooler surface, together with formation of ice or dew at sensitive areas of the system (contacts, IC pins, etc.). Once internal condensation occurs, trouble-free operation cannot be guaranteed, independent of temperature.

Before putting into operation, the system must be checked for internal formation of condensation or ice. Only with a minute formation of ice, direct

evaporation (sublimation) may be expected; otherwise the system must be heated and dried while switched off.

A system without visible internal formation of ice or condensation should be heated up with its own heat dissipation, as homogeneously (and subsequently as slow) as possible; the ambient temperature should then always be lower than the one of the outgoing air.

If it is absolutely necessary to operate the cold system immediately within warm ambient air, this air must be dehydrated. In such a case, the absolute humidity must be so low that the relative humidity, related to the coldest system surface, always remains below 100%.

Ensure that the enclosed air is as dry as possible when powering off (i.e. before switching off in winter, aerate the room with cold, dry air, and remove humid objects as clothes from the room).

These relationships are visible from the following climatogram. For a controlled procedure, thermometer and hygrometer as well as a thermometer within the system will be required.

**Example 1:** An OB-van having an internal temperature of 20 °C and relative humidity of 40% is switched off in the evening. If temperature falls below +5 °C, dew or ice will be forming.

**Example 2:** An OB-van is heated up in the morning with air of 20 °C and a relative humidity of 40%. On all parts being cooler than +5 °C, dew or ice will be forming.

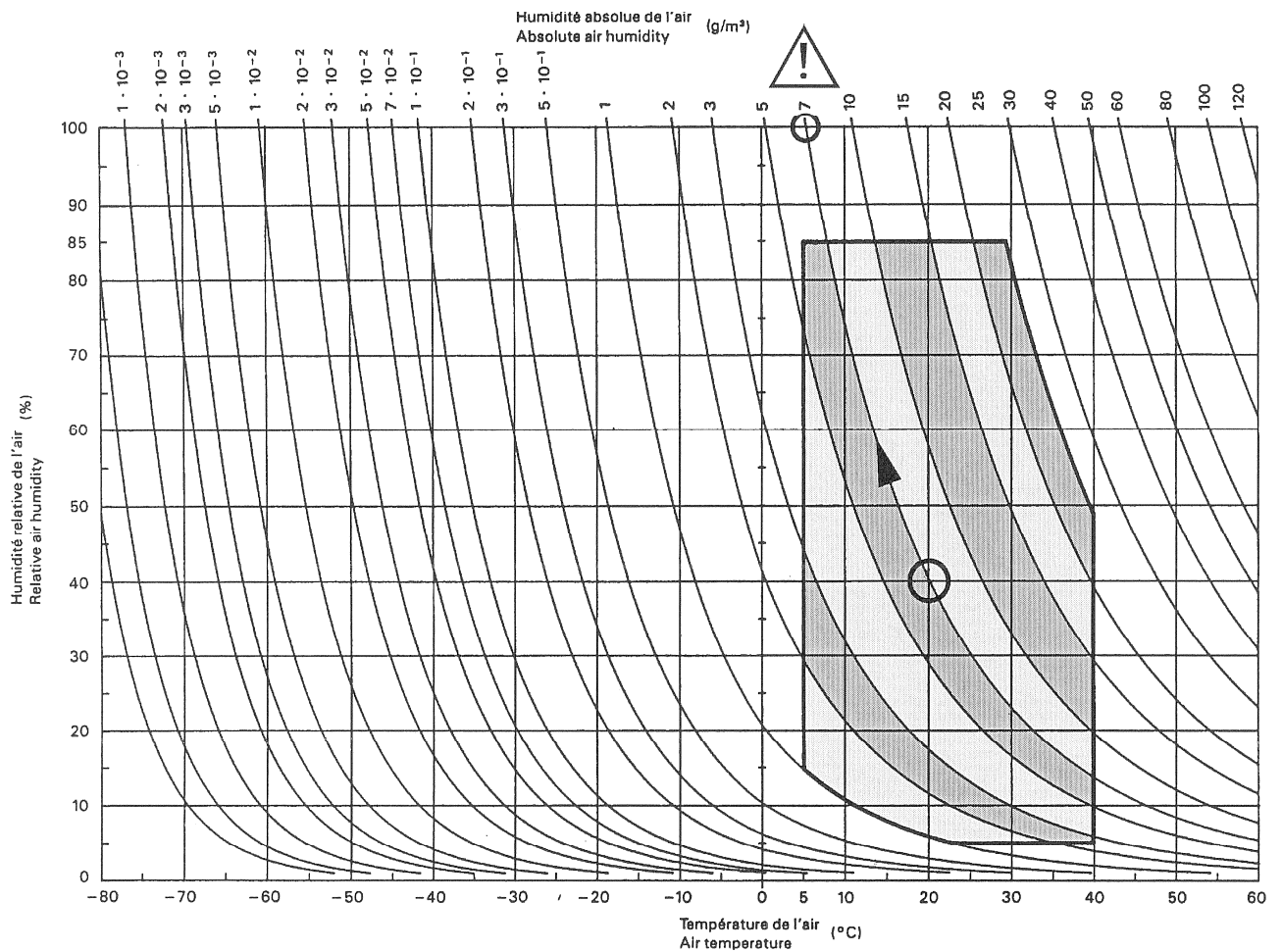
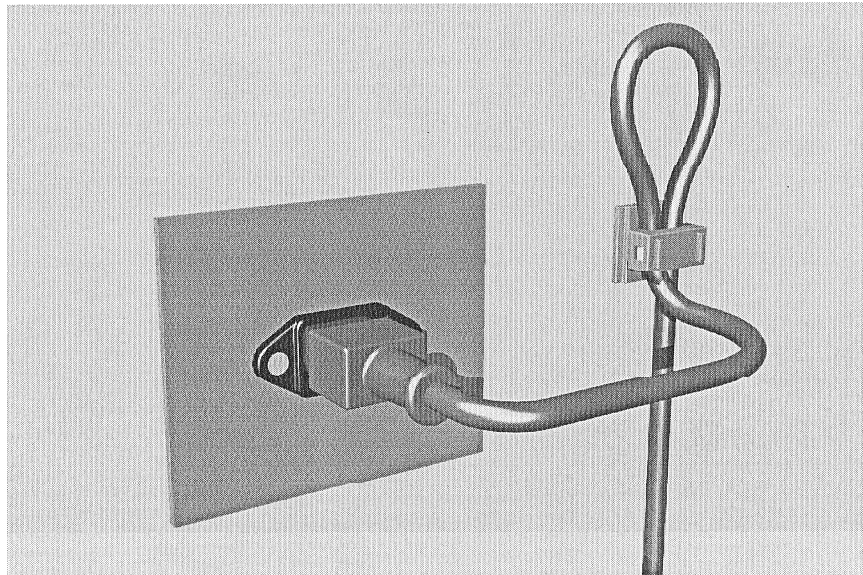

Figure B.3 – Climatogramme pour catégorie 3K3  
Climatogram for class 3K3

## Appendix 2: Mains Connector Strain Relief

For anchoring connectors without a mechanical lock (e.g. IEC mains connectors), we recommend the following arrangement:



**Procedure:** The cable clamp shipped with your unit is auto-adhesive. For mounting please follow the rules below:

- The surface to be adhered to must be clean, dry, and free from grease, oil, or other contaminants. Recommended application temperature range is +20...+40 °C.
- Remove the plastic protective backing from the rear side of the clamp and apply it firmly to the surface at the desired position. Allow as much time as possible for curing. The bond continues to develop for as long as 24 hours.
- For improved stability, the clamp should be fixed with a screw. For this purpose, a self-tapping screw and an M4 bolt and nut are included.
- Place the cable into the clamp as shown in the illustration above and firmly press down the internal top cover until the cable is fixed.

## Appendix 3: Software License

---

*Use of the software is subject to the Studer Professional Audio Software License Agreement set forth below. Using the software indicates your acceptance of this license agreement. If you do not accept these license terms, you are not authorized to use this software.*

Under the condition and within the scope of the following Terms and Conditions, Studer Professional Audio AG (hereinafter “Studer”) grants the right to use programs developed by Studer as well as those of third parties which have been installed by Studer on or within its products. References to the license programs shall be references to the newest release of a license program installed at the Customer’s site.

### Programs Covered by the Agreement

---

|                                   |   |
|-----------------------------------|---|
| <b>License Programs of Studer</b> | <p>The following Terms and Conditions grant the right to use all programs of Studer that are part of the System and/or its options at the time of its delivery to the Customer, as well as the installation software on the original data disk and the accompanying documentation (“License Material”). In this Agreement the word “Programs” shall have the meaning of programs and data written in machine code.</p> <p>Using the software indicates your acceptance of this license agreement. If you do not accept these license terms, you are not authorized to use this software.</p>  |
| <b>Programs of Third Parties</b>  | <p>Programs of third parties are all programs which constitute part of the System and/or its options at the time of delivery to the Customer but have not been developed by Studer. The following conditions are applicable to programs of third parties:</p> <ul style="list-style-type: none"> <li>• The right to use third parties’ programs is governed by the License Agreement attached hereto (if applicable), which is an integral part of this Agreement. The Customer shall sign any and all License Agreements for all further programs of third parties installed on the system. The Customer shall be deemed to have received all License Agreements upon delivery of the system and/or its options.</li> <li>• Studer shall accept no responsibility or liability for, and gives no warranties (express or implied) as to the programs of third parties. The Customer waives any and all claims versus Studer for any consequential damages, which might occur due to defects of these programs.</li> </ul> |

### Right of Use

---

|                                  |  |
|----------------------------------|--|
| <b>Principle</b>                 | <p>Studer grants the Customer the non-exclusive right to use the License Material in one copy on the system and/or its options as laid down by the Sales Agreement concluded between the parties and all Terms and Conditions which shall be deemed to form and be read and construed as part of the Sales Agreement. This right is assignable according to the “Assignability” paragraph hereinafter.</p> |
| <b>Customized Configurations</b> | <p>The Customer is not entitled to alter or develop further the License Material except within the expressly permitted configuration possibilities given by the software installed on the system or elsewhere. All altered programs, including but not limited to the products altered within the permitted configuration possibilities, are covered by this License Agreement.</p>                        |

**Reverse Engineering** Reverse engineering is only permitted with the express consent of Studer. The consent of Studer can be obtained but is not limited to the case in which the interface-software can not be provided by Studer. In any case Studer has to be informed immediately upon complete or partial reverse engineering.

**Copying the License Material** The Customer is entitled to make one copy of all or parts of the License Material as is necessary for the use according to this Agreement, namely for backup purposes. The Customer shall apply the copyright of Studer found on the License Material onto all copies made by him. Records shall be kept by the Customer regarding the amount of copies made and their place of keeping. The responsibility for the original program and all copies made lies with the Customer. Studer is entitled to check these records on first request. Copies not needed anymore have to be destroyed immediately.

**Disclosure of License Material** The License Material is a business secret of Studer. The Customer shall not hand out or in any way give access to parts or the complete License Material to third parties nor to publish any part of the License Material without prior written consent of Studer. The Customer shall protect the License Material and any copies made according to the paragraph above by appropriate defense measures against unauthorized access. This obligation of non-disclosure is a perpetual obligation. Third parties are entitled to have access to the License Material if they use the License Material at the Customer's site in compliance with this Agreement. Under no circumstance are third parties entitled to have access to the installation software on the original data media. The Customer shall safeguard the original data media accordingly.

**Assignability** The rights granted to the Customer according to this License Agreement shall only be assignable to a third party together with the transfer of the system and/or its options and after the prior written consent of Studer.

## **Rights to License Material**

---

With the exception of the right of use granted by this License Agreement all proprietary rights to the License Material, especially the ownership and the intellectual property rights (such as but not limited to patents and copyright) remain with Studer even if alterations, customized changes or amendments have been made to the License Material.

Studer's proprietary rights are acknowledged by the Customer. The Customer shall undertake no infringements and make no claims of any patent, registered design, copyright, trade mark or trade name, or other intellectual property right.

## **Warranty, Disclaimer, and Liability**

---

For all issues not covered herewithin, refer to the "General Terms and Conditions of Sales and Delivery" being part of the sales contract.

---

## 1. General Information

---

|       |  |    |
|-------|--|----|
| 1.1   | Quick-Reference Description.....                   | 1  |
| 1.2   | Standard Versions.....                             | 4  |
| 1.3   | Options.....                                       | 5  |
| 1.4   | Accessories .....                                  | 6  |
| 1.5   | Maintenance Hints for the Service Personnel.....   | 8  |
| 1.5.1 | General .....                                      | 8  |
| 1.5.2 | Abbreviations .....                                | 9  |
| 1.5.3 | Powers of Ten.....                                 | 10 |
| 1.5.4 | Code Letters and Colors .....                      | 10 |
| 1.5.5 | Components Sensitive to Electrostatic Charges..... | 12 |
| 1.6   | Technical Data.....                                | 13 |
| 1.6.1 | General Data .....                                 | 13 |
| 1.6.2 | Electrical Data .....                              | 14 |
| 1.7   | Standard Calibration Data .....                    | 19 |

## 1. General Information

---

### 1.1 Quick-Reference Description

---

Due to its compact and extremely sturdy design, its variety of interfaces, and the exceptional operating convenience provided by multiple microprocessors, the A820 MCH is eminently suited for applications in broadcasting or television, in film and recording studios, in theaters, and in scientific institutes, not only in individual configurations but also in modern synchronization systems.

Its salient features are:

- Tape deck:**
- Extremely stable die-cast aluminum alloy chassis for the tape transport mechanism, the headblock, the pinch roller assembly, and other units.
  - Hall-commutated brushless DC capstan motor with quartz reference and capacitive sensing of the speed and the direction of rotation for highly accurate tape speed and fast acceleration and deceleration; also supports reverse play.
  - Agile tape transport with high spooling speed (up to 15 m/sec). Electronically controlled tape tension with servo-controlled DC disc rotor motors with photoelectric speed and rotation direction sensing and noncontacting tape tension sensors. Clocked spooling motor control for minimal power dissipation.
  - Easy editing: variable spooling speed; the high frequencies are lowered during cueing. The tape tension control circuit is also active in the STOP position. Manual tape shuttling is possible on both reels in either direction.
  - Manually operable head shield above the record and reproduce head; can remain closed in spooling mode.
  - Splicing rail on the cover of the headblock.
  - Reel capacity max. 356 mm (14"); operation with different reel sizes possible because the inertia is automatically sensed.
  - Accurate electronic tape counter with real-time indication for all tape speeds, positive and negative time indication, zero locator and address locator for up to 5 addresses.  
Photoelectric scanning of the guide roller rotation by light barriers.
  - In varispeed mode, the tape speed can be varied from -35.15% to +54.21%, relative to the nominal speed.
  - Line voltage switch-selectable from 100 to 120 V / 200 to 240 VAC,  $\pm 10\%$ , 50 ... 60 Hz.
- Audio:**
- The basic version is available as an 8-channel/1", 16-channel/2", or 24-channel/2" machine.  
16- and 24-channel machines can be converted to 8 channels by means of a special kit.  
16-Channel machines can be converted to 24 channels by exchanging the headblock and by retrofitting the audio electronics.
  - Each headblock is equipped with an electronic index that ensures that all tape deck and audio parameters previously set with this headblock are automatically reestablished. This means that no recalibration is necessary after the conversion from 24 to 16 channels.
  - The parameter memories can hold values for two different tape types, separated individually for 8-, 16- and 24-channel headblocks. The calibration data for NAB/CCIR equalization are stored in separate memories.
  - Selectable nominal level



- The A820 is equipped as standard feature with the Dolby HX PRO system for bias adjustment.
- The removable audio operating panel (VU-meter panel) contains the selectors for the channel status (ready, safe, input, sync, repro), the output meter (switchable between VU and PPM indication), as well as the input keys of the calibration computer with integrated tone generator.
- The rack-mount drawers accommodate modules for an internal noise reduction system such as Telcom c4d, Dolby A or Dolby SR.
- Three programmable tape speeds (7.5 / 15 / 30 ips).
- Inputs and outputs are balanced and floating, optionally with or without input/output transformer.
- Connectors for fader start, parallel and serial remote control.

### Operator facilities:

- Maximum operating convenience due to multiple processor architecture.
- The last operating state of the tape deck is saved when the machine is switched off: tape timer, locator addresses, audio parameters, speed. STOP and SAFE are automatically activated after the machine is switched on again.
  - Drop-in by pressing the REC key in play mode (internally programmable).
  - Drop-out by pressing PLAY in record mode.
  - Reduced spooling speed (LIBRARY WIND): a lower spooling speed can be activated for producing library pancakes.
  - Zero-locator: automatic searching of the tape address 0.00.00.0 (tape timer).
  - Transfer locators LOC 1 ... LOC 5: storage of five tape addresses for automatic searching. The addresses can be read out without activating the function.
  - Programmable keys (soft keys): each key can be assigned to any of approx. 100 available functions, for example:
    - REVERSE PLAY (playback in reverse direction)
    - FADER (local keypad disabled, only fader start possible)
    - TAPE DUMP (waste basket mode, take-up motor disabled)
    - REM CONTR (local keypad disabled, operation only with remote control)
    - REHEARSE (simulation of electronic editing)
    - SPOT ERASE (activation of the erase circuit without tape transport, the tape can be moved manually)
    - AUTO MUTE (automatic muting of the audio channels in spooling mode), etc.These keys have a special recess into which self-adhesive labels can be placed.
  - Internal standard testing system for the principal functions, with error messages: the automatic power-on test is partially repeated.
  - Parameter input via microprocessor; eliminates the conventional trimmer potentiometers, and the calibration can be performed manually as well as automatically.
  - Built-in audio oscillator with wobble function for level adjustment.
  - Special indicating mode on the VU-meter panel for calibration: the instrument range is switched to  $\pm 2.5$  dB with a resolution of 0.1 dB.
  - Automatic and manual alignment of the Dolby/Telcom parameters.
  - The tape deck and audio parameters remain stored even when the machine is switched off. Via a biphase interface, all parameters can also be loaded from tape, stored on tape, or compared with those on tape.

- Remote control systems:** Various solutions are supported by the flexible interfaces:
- Parallel tape deck and synchronizer interface, identical with A820 1/4" and 1/2" machines.
  - Serial interfaces for autolocator, tape deck control, remote counter, channel remote control, and external bar graph displays.
- Available as options are:**
- Serial RS 232 interface according to ASCII or binary protocol, and RS 422 according to SMPTE/EBU standard.
  - NRS interface for controlling external noise reduction systems (Dolby or Telcom).
  - STUDER TLS 4000 synchronizer.
- Service:**
- Very easy to maintain due to the modular design and tiltable transport chassis.
  - All PC boards are easily accessible
  - All ICs are socket mounted.
  - Practically no recalibration required when electronic or mechanical assemblies are replaced.

| 1.2            | Standard Versions:   | Order Number |
|----------------|--|--------------|
| A820-8-1"      | 8-Channel machine for 1" tape<br><b>Note:</b> The A820-8-1" cannot be upgraded to 16 or 24 channels. | 60.118.20071 |
| A820-16(24)-2" | 16-Channel machine for 2" tape, field upgradable to 24 channels, with 24 bargraphs                   | 60.118.20072 |
| A820-24-2"     | 24-Channel machine for 2" tape   | 60.118.20073 |
|                | ■ Additional operating and service manual (English)  | 10.27.0665   |
|                | ■ Additional operating and service manual (German)   | 10.27.0651   |
|                | ■ Additional schemata, options and spare parts manual (G/E)  | 10.27.1900   |
|                | ■ Additional operating and service manual for autolocator (G/E)                                      | 10.27.1073   |

**1.3 Options:**

Order Number

|  |   |   |
|--|---|---|
| <b>Serial Interface RS 232:</b>  | For use with the TLS 4000<br>9-Pin connector, type D, screw lock  | 20.820.393.00<br>20.020.303.07                  |
| <b>Serial Interface SMPTE/EBU:</b>   | (RS 422 and RS 232), SMPTE/EBU protocol and binary transmission<br>9-Pin connector, D-type, screw lock  | 20.820.394.00<br>20.020.303.07                  |
| <b>Noise Reduction System:</b>   | Interface for noise reduction system<br>15-Pin connector, D-type, screw lock<br>(1 connector for 8 channels each)   | 20.820.385.00<br>20.020.303.08                  |
| <b>Internal Noise Reduction System Interface, including all wiring, ready for Plug-In:</b> |   |   |
| <b>Important:</b>  | <u>Interfaces as listed come complete with machine only.</u>  |   |
|  | Motherboard and interfaces for internal noise reduction system (compatible with TELCOM C4E):<br>For 8-channel machines<br>For 16-channel machines<br>For 24-channel machines  | 20.820.383.00<br>20.820.371.00<br>20.820.372.00 |
|  | Motherboard and interfaces for internal noise reduction system (compatible with TELCOM C4DM, DOLBY A cat. 22 and DOLBY SR cat. 280):<br>For 8-channel machines<br>For 16-channel machines<br>For 24-channel machines          | 20.820.373.00<br>20.820.374.00<br>20.820.375.00 |
|  | Motherboard and interfaces for internal noise reduction system (compatible with DOLBY A/SR cat. 300, DOLBY SR cat. 350 and DOLBY A cat. 450):<br>For 8-channel machines<br>For 16-channel machines<br>For 24-channel machines | 20.820.379.00<br>20.820.380.00<br>20.820.381.00 |
| <b>Time Code Channel:</b>  | With high-speed reader (can be plugged into any channel in place of the standard audio channel)   | 20.820.392.00                                   |
| <b>Synchronizer Connector Panel:</b>   | For machines that are to be equipped with a built-in Studer TLS 4000 synchronizer   | 20.820.395.00                                   |
| <b>Noise Reduction Modules:</b>  | Telcom C4DM module, compander board, compatible with Dolby Cat. No. 22  | 10.658.010.00                                   |
|  | Telcom C4E module, compander board, eurocard  | 10.658.020.00                                   |
|  | Dolby spectral recording (SR) module, Cat. No. 280  | 10.312.060.00                                   |
|  | Dolby A-type module, Cat. No. 22  | 10.312.020.00                                   |
|  | Dolby A-type/spectral recording (A/SR) module, Cat. No. 300   | 10.312.070.00                                   |
|  | Dolby spectral recording (SR) module, Cat. No. 350  | 10.312.110.00                                   |
|  | Dolby A-type module, Cat. No. 450   | 10.312.450.00                                   |

| 1.4 Accessories  | Order Number  |
|--|---------------|
| <b>Remote control units and stands</b>   |               |
| <b>Auto Locator A820:</b>  | 21.328.240.00 |
| With 20 memory locations and varispeed controller, desktop housing, with 15 m cable  |               |
| 9-Pin connector, D-type, female, screw lock, key in position 4   | 20.020.303.21 |
| <b>Auto Locator A820:</b>  | 21.328.230.00 |
| With 20 memory locations and varispeed controller, STUDER standard module size, 6 modules wide, with 15 m cable  |               |
| 9-Pin connector, D-type, female, screw lock, key in position 4   | 20.020.303.21 |
| <b>Audio Remote Control for 8 Channels:</b>  | 21.328.501.00 |
| STUDER standard module size, 11 modules wide, with 15 m cable  |               |
| <b>Note:</b> only for 8-channel machines (A820-8-1")   |               |
| <b>Audio Remote Control for 24 Channels:</b>   | 21.328.503.00 |
| STUDER standard module size, 11 modules wide, with 15 m cable  |               |
| <b>Note:</b> only for 16- and 24-channel machines (A820-16(24)-2" & A820-24-2")  |               |
| <b>Remote Control Stand:</b>   | 1.328.190.00  |
| With double rack frame, for 2x11 STUDER standard modules   |               |
| <b>Remote Control Stand:</b>   | 1.328.171.00  |
| With triple rack frame, for 3x11 STUDER standard modules   |               |
| <b>Remote Control Stand:</b>   | 1.328.170.00  |
| With triple rack frame, for 2x11 STUDER standard modules and 1 STUDER system controller SC4008   |               |
| <b>Desktop Housing:</b>  | 1.328.095.00  |
| For 6 STUDER standard modules  |               |
| <b>Covers for Remote Control Stands:</b>   | 1.328.185.00  |
| ■ 1 module wide  |               |
| ■ 2 modules wide   | 1.328.186.00  |
| ■ 3 modules wide   | 1.328.187.00  |
| ■ 5 modules wide   | 1.328.189.00  |
| ■ 11 modules wide  | 1.328.188.00  |
| <b>Parallel Channel Remote Control:</b>  | 21.328.500.00 |
| Interface for individual control of the channel safe/ready and the channel master status via the mixing console. With channel ready, record, and channel master status tallies. With 15 m cable. |               |
| 78-Pin connector, D-type, with lock. 1 connector for 8 channels each   | 20.540.211.10 |

**Others**

|                                       |   |               |
|---------------------------------------|---|---------------|
| <b>Headblocks:</b>                    | 8-Channel headblock (1")  | 1.050.150.00  |
|                                       | 8-Channel headblock (1"), special version for adaptation to 2" tape decks                             | 1.050.153.00  |
|                                       | 16-Channel headblock (2")   | 1.050.151.00  |
|                                       | 24-Channel headblock (2")   | 1.050.152.00  |
| <b>Conversion Kits:</b>               | 8-Channel 1" conversion kit for A820-16(24)-2" and A820-24-2"   | 1.820.494.00  |
| <b>Reels:</b>                         | NAB metal reel, empty, 1" (10.5")   | 10.213.001.02 |
|                                       | NAB metal reel, empty, 1" (14")   | 10.353.001.01 |
|                                       | NAB metal reel, empty, 2" (10.5")   | 10.213.001.03 |
|                                       | NAB metal reel, empty, 2" (14")   | 10.353.001.02 |
|                                       | Reel flange DIN-type (14")  | 1.013.401.00  |
| <b>Service Aids:</b>                  | Tool case (standard content) with soldering iron and demagnetizing choke for 110 V                    | 20.020.001.20 |
|                                       | Tool case (standard content) with soldering iron and demagnetizing choke for 220 V                    | 20.020.001.21 |
|                                       | Supplementary tool kit A820 MCH, incl. extension boards   | 20.020.001.40 |
|                                       | Extender board, 39-pin, for audio and logic modules   | 1.820.799.00  |
|                                       | Extender board, 64-pin, for logic modules   | 1.228.324.81  |
| <b>STUDER Cleaning Kit in a Case:</b> | Contains 1 bottle of head cleaner, 1 bottle of aluminite cleaner, lint-free nonwoven fleece, buckskin | 10.496.010.00 |
|                                       | Head cleaner, replacement bottle  | 10.496.021.00 |
|                                       | Head cleaner, 1 litre bottle  | 10.496.022.00 |
|                                       | Aluminite cleaner, replacement bottle   | 10.496.025.00 |
|                                       | Aluminite cleaner, 1 litre bottle   | 10.496.026.00 |

## 1.5 Maintenance Hints for the Service Personnel

### 1.5.1 General

The following method is used for defining the IC position numbers:  
With the component side of the PCB facing the viewer and with the edge connector on the right-hand side, an imaginary coordinate network is overlaid on the component side. Each square takes the space occupied by a DIL-16 IC. For a European standard board (100 mm x 160 mm) there is space for 48 ICs, corresponding to six columns and eight rows. The reference point for the IC is the IC corner located nearest to coordinate 1/1. The column is in the tens position, the row in the units position. Together they give the IC position number.

**Example:** IC 48  
└─ Row 8  
└─ Column 4

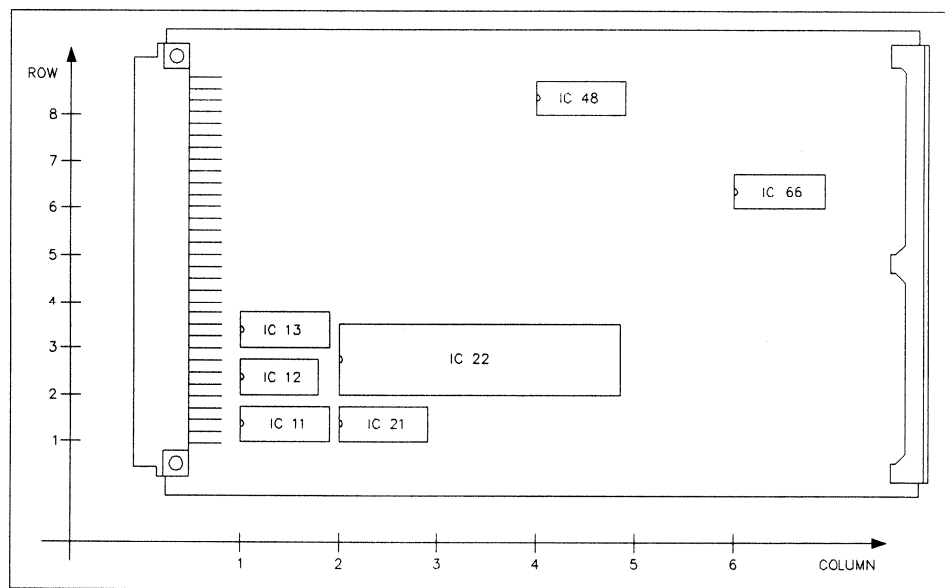

Fig. 1.5.1

## 1.5.2 Abbreviations

|     |                                       |
|-----|---------------------------------------|
| A   | assembly                              |
| ANT | antenna                               |
| B   | bulb                                  |
| BA  | battery, accumulator                  |
| BR  | optocoupler (bulb --> LDR)            |
| C   | capacitor                             |
| D   | diode, DIAC                           |
| DL  | LED                                   |
| DLQ | optocoupler (LED --> phototransistor) |
| DLR | optocoupler (LED --> LDR)             |
| DLZ | LED-array, 7 segment display          |
| DP  | photodiode                            |
| DZ  | rectifier                             |
| E   | electronic part                       |
| EF  | headphones                            |
| F   | fuse                                  |
| FL  | filter                                |
| H   | head (sound-, erase-)                 |
| HC  | hybrid circuit (thick/thin film)      |
| HE  | hall element                          |
| IC  | integrated circuit                    |
| J   | jack (femal)                          |
| JS  | jumper                                |
| K   | relay, contactor                      |
| L   | inductor                              |
| LS  | loudspeaker                           |
| M   | motor                                 |
| ME  | meter                                 |
| MIC | microphone                            |
| MP  | mechanical part                       |
| P   | plug (male)                           |
| PU  | pick up                               |
| Q   | transistor, FET, thyristor, TRIAC     |
| QP  | phototransistor                       |
| QP7 | phototransistor array                 |
| R   | resistor                              |
| RP  | light depending resistor (LDR)        |
| RT  | temperature sensitive resistor        |
| RZ  | resistor array                        |
| S   | switch                                |
| T   | transformer                           |
| TL  | delay line                            |
| TP  | test point                            |
| W   | wire, stranded wire                   |
| X   | socket, holder                        |
| XB  | lamp socket                           |
| XF  | fuse holder                           |
| XIC | IC socket                             |
| Y   | quartz, piezoelectric element         |
| Z   | network, array                        |



### 1.5.3 Powers of Ten

| Name   | Abbreviation   | Value      |
|--------|----------------|------------|
| Tera-  | T              | $10^{12}$  |
| Giga-  | G              | $10^9$     |
| Mega-  | M              | $10^6$     |
| Kilo-  | k              | $10^3$     |
| Milli- | m              | $10^{-3}$  |
| Mikro- | $\mu$          | $10^{-6}$  |
| Nano-  | n ( $m\mu$ )   | $10^{-9}$  |
| Pico-  | p ( $\mu\mu$ ) | $10^{-12}$ |
| Femto- | f              | $10^{-15}$ |

( ) = frequently used in the United States

### 1.5.4 Code Letters and Colors

#### Resistor

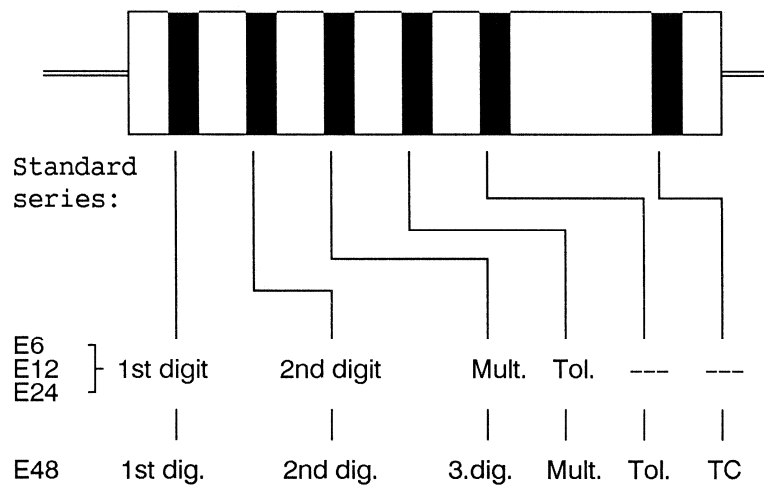

| Color  | Digit | Multiplier | Tolerance | TK                        |
|--------|-------|------------|-----------|---------------------------|
| gold   | -     | 0,01       | 5,0 %     | -                         |
| silver | -     | 0,1        | 10,0 %    | -                         |
| black  | 0     | 1          | -         | -                         |
| brown  | 1     | 10         | 1,0 %     | $100 \cdot 10^{-6}/K$     |
| red    | 2     | 100        | 2,0 %     | $50 \cdot 10^{-6}/K \#\#$ |
| orange | 3     | 1 k        | -         | $15 \cdot 10^{-6}/K$      |
| yellow | 4     | 10 k       | -         | $25 \cdot 10^{-6}/K$      |
| green  | 5     | 100 k      | 0,5 %     | -                         |
| blue   | 6     | 1 M        | 0,25 %    | -                         |
| violet | 7     | 10 M       | 0,1 %     | -                         |
| grey   | 8     | -          | -         | -                         |
| white  | 9     | -          | -         | -                         |

\#\# either no mark for temperature coefficient, or red

**Capacitors**

The tolerance category is sometimes specified by a letter after the rated capacitance.

|   |   |       |
|---|---|-------|
| D | = | 0,5 % |
| F | = | 1 %   |
| G | = | 2 %   |
| J | = | 5 %   |
| K | = | 10 %  |
| M | = | 20 %  |

**Molded RF Coils**

A wide silver-colored ring and 4 thin, differently colored rings identify molded RF coils. The wide silver ring indicates the start of the counting direction. The second, third, and fourth ring indicate the inductance in micro Henry ( $\mu\text{H}$ ), where two of the three rings represent the numeric value, the third one either a multiplier or the decimal point. In the latter case it has a golden color. The fifth ring indicates the tolerance in percent ( $\pm$ ).

| Color      | Digit | Multiplier | Tolerance |
|------------|-------|------------|-----------|
| black      | 0     | 1          | -         |
| brown      | 1     | 10         | 1 %       |
| red        | 2     | 100        | 2 %       |
| orange     | 3     | $10^3$     | -         |
| yellow     | 4     | $10^4$     | -         |
| green      | 5     | $10^5$     | 0,5 %     |
| blue       | 6     | $10^6$     | -         |
| violet     | 7     | $10^7$     | -         |
| grey       | 8     | $10^8$     | -         |
| white      | 9     | $10^9$     | -         |
| gold       | -     | -          | 5 %       |
| silver     | -     | -          | 10 %      |
| any (nat.) | -     | -          | 20 %      |

**Examples:**

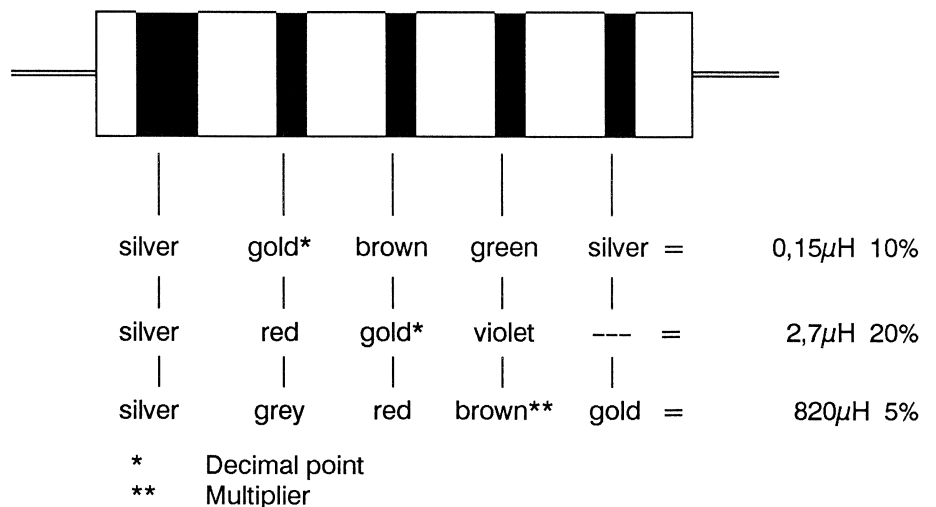

## Inductors, Transformers on Ferrit Cores

Inductors and transformers on ferrite cores are marked with three colored dots (for color codes, refer to the table in the section "Resistors", the two left-hand columns). These dots represent the last three digits of the STUDER standard number, the largest of them identifying the start. The first digits of the standard number (1.022.---) are always the same.

- Examples:**
- Driver Transformer, 150 kHz.
  - Standard number: 1.022.211
  - Color code: red (large dot), brown, brown

Terminal 1 of the winding form is usually identified by a lobe; if not the winding form features a yellow dot near terminal No. 1.6

## 1.5.5 Components Sensitive to Electrostatic Charges

---

MOS (Metal oxide semiconductor) components are extremely sensitive to static charges. Please observe therefore the following regulations:

- Components sensitive to static charges are stored and shipped in protective packages. On the packages you find the subsequent symbol:

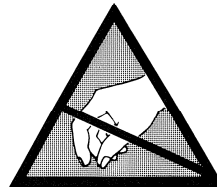

- Avoid any contact of connector pins with foam packages and -foils made styrofoam or similar chargeable package material.
- Don't touch the connector pins unless your wrist is grounded with a conducting wristlet.
- Use a grounded conducting mat when working with sensitive components.
- Never plug or unplug PCBs containing sensitive components when the equipment is switched on. Before plugging or unplugging PCBs, the equipment has to be switched off for five seconds at least!

## 1.6 Technical Data

### 1.6.1 General Data

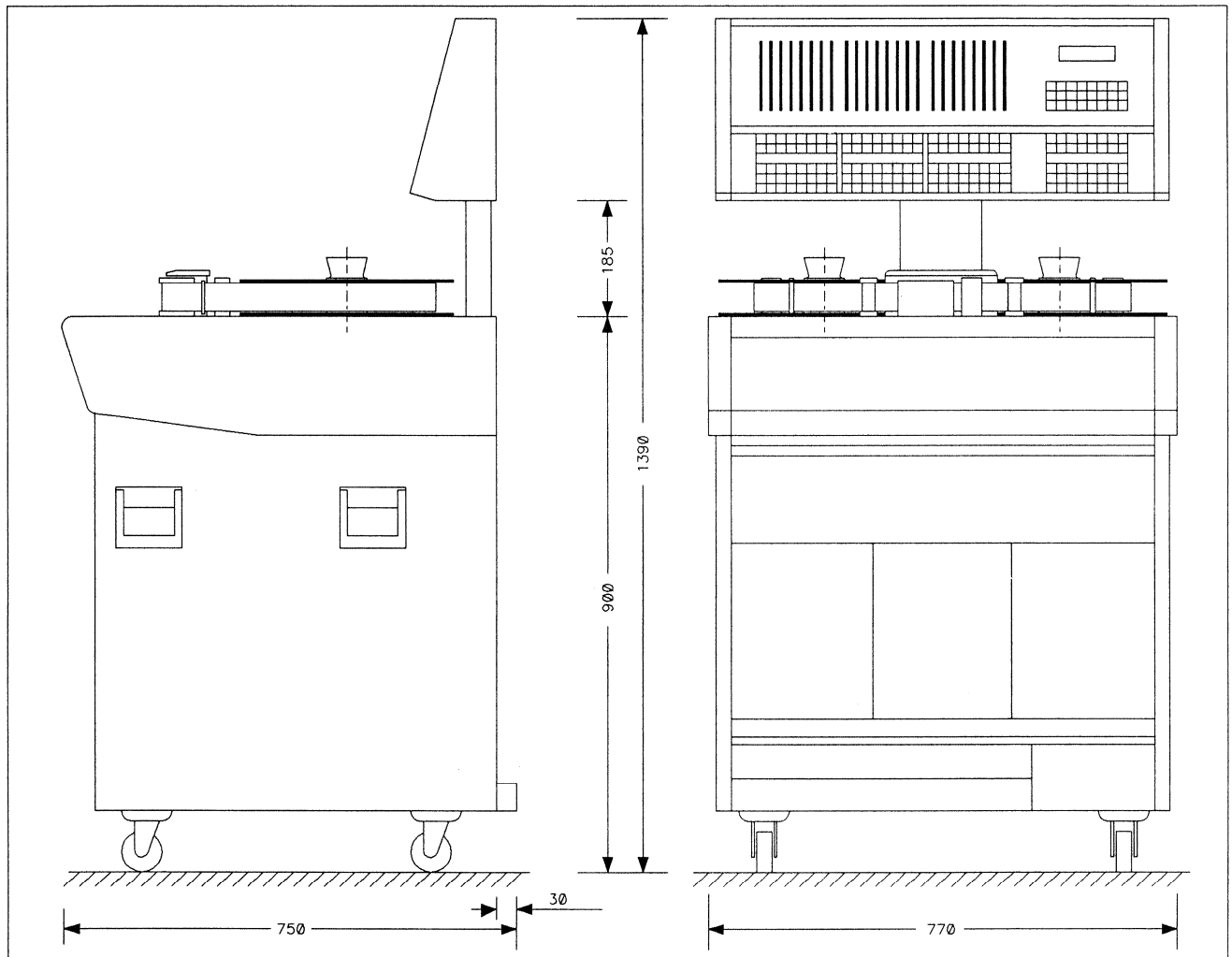

Fig. 1.6.1 [mm]

**Ambient temperature:** 0°C to +35°C (+32°F to 95°F)  
(if good air circulation is provided)

**Relative humidity:** 20% ... 95%, non condensing

**Weights:** net, without packing

|            |        |           |
|------------|--------|-----------|
| ■ A820-8:  | 184 kg | (405 lbs) |
| ■ A820-16: | 221 kg | (487 lbs) |
| ■ A820-24: | 225 kg | (495 lbs) |

1.6.2 Electrical Data

We reserve the right to make alterations as technical progress may warrant.

**Nominal tape speeds:** 30 – 15 – 7.5 ips  
 76.2 – 38.1 – 19.05 cm/s  
 Any of the nominal tape speeds can be selected via the speed select keys.  
 Nominal speed adjustable  $\pm 0.2\%$  in 0.025% steps

**Variable tape speeds:**  $\pm 7$  semitones from nominal speed (+54% to -35%) displayed in % HT (half tones) or IPS; programmable.

**Tape speed deviation:** Max.  $\pm 0.2\%$

**Tape slip:** Max. 0.1%

**Tape reel type:** Up to 14", NAB hub

**Tape width:** 25.4 mm (1")  
 50.8 mm (2")

**Wow and flutter:** Peak weighted according to DIN 45507 or IEC Publ. 386, respectively. Ambient temperature 0° ... 35°C (32°F ... 95°F).

|                     |                     |                       |
|---------------------|---------------------|-----------------------|
| 30 ips<br>76.2 cm/s | 15 ips<br>38.1 cm/s | 7.5 ips<br>19.05 cm/s |
| max. 0.03%          | max. 0.04%          | max. 0.06%            |

**Tape timer:** 6-digit LED, indicating hours, minutes, secondes and tenth of secondes for all tape speeds. Counts past zero with leading negative sign.  
 Range: -9 h 59 min 59.9 s to 23 h 59 min 59.9 s

**Winding speed:** Programmable, 4 ... 590 ips (0.1 ... 15 m/s), automatic speed reduction at tape end.

**Rewind time:** Approx. 65 s for 762 m (2'500 ft) reel of tape (at 12 m/s wind speed setting).  
 Approx. 55 s for 762 m (2'500 ft) reel of tape (at 15 m/s wind speed setting).

**Input:** Electronically balanced, without input transformer:

- Impedance  $\geq 20\text{ k}\Omega$ , 30 Hz ... 20 kHz (with balanced input signal).
- Impedance  $\geq 10\text{ k}\Omega$ , 30 Hz ... 20 kHz (with unbalanced input signal).

or optionally available:

Balanced and floating, with input transformer

- Impedance  $\geq 10\text{ k}\Omega$ , 30 Hz ... 20 kHz.

**Input level:**

- Relative to reference flux, internally programmable, nominal +6 / +10 / +14 / +16 dBu
- Relative to operating level (according to NAB), internally programmable, nominal 0 / +4 / +8 / +10 dBu  
 (Internal adjustment range of the operating flux with above input levels: 100 to 1000 nWb/m)

**Maximum input levels:**

- With input transformer: +24 dBu
- Without input transformer: +28 dBu

(if nominal input level, relative to operating level, is set to 0 / +6 dBu: +26 dBu)

**Output:** Electronically balanced, without output transformer

- Impedance  $\leq 30 \Omega$ , 30 Hz ... 20 kHz. Load  $\geq 200 \Omega$

Or optionally available:  
Balanced and floating, with output transformer

- Impedance  $\leq 50 \Omega$ , 30 Hz ... 20 kHz. Load  $\geq 200 \Omega$

**Note:** When selecting output transformers, input transformers are mandatory.

**Output level:**

- Relative to reference flux, internally programmable, nominal +6 / +10 / +14 / +16 dBu
- Relative to operating level (according to NAB), internally programmable, nominal 0 / +4 / +8 / +10 dBu  
(Internal adjustment range of the reproduce gain for operating flux of 100 to 1000 nWb/m)

**Maximum output level:**

- With output transformer (Load  $\geq 200 \Omega$ ): +24 dBu
- Without output transformer:
  - Balanced (Load  $\geq 200 \Omega$ ): +26 dBu
  - Unbalanced (Load  $\geq 200 \Omega$ ): +24 dBu
  - Balanced (Load  $\geq 600 \Omega$ ): +30 dBu
 (If the nominal output level, relative to operating level, is set to 0 / 6 dBu).
  - Unbalanced (Load  $\geq 600 \Omega$ ): +24 dBu

**Equalization:**

|       | 30 ips<br>76.2 cm/s          | 15 ips<br>38.1 cm/s  | 7.5 ips<br>19.05 cm/s |
|-------|------------------------------|----------------------|-----------------------|
| NAB:  | 17.5/ $\infty$ $\mu$ s (AES) | 50/3180 $\mu$ s      | 50/3180 $\mu$ s       |
| CCIR: | 17.5/ $\infty$ $\mu$ s (AES) | 35/ $\infty$ $\mu$ s | 70/ $\infty$ $\mu$ s  |

**Frequency response:** Record / reproduce

|                | 30 ips<br>76.2 cm/s | 15 ips<br>38.1 cm/s | 7.5 ips<br>19.05 cm/s |
|----------------|---------------------|---------------------|-----------------------|
| $\pm 1$ dB     | 60 Hz...20 kHz      | 60 Hz...18 kHz      | 60 Hz...12 kHz        |
| $\pm 2$ dB     | 50 Hz...20 kHz      | 30 Hz...20 kHz      |                       |
| +2 dB<br>-3 dB |                     |                     | 30 Hz...15 kHz        |

**Sync frequency response:** Jumper selectable "narrow or wide"

**narrow:**

|            | 30 ips<br>76.2 cm/s | 15 ips<br>38.1 cm/s | 7.5 ips<br>19.05 cm/s |
|------------|---------------------|---------------------|-----------------------|
| $\pm 2$ dB | 50 Hz...12 kHz      | 30 Hz...12 kHz      | 30 Hz...8 kHz         |

wide:

|       | 30 ips<br>76.2 cm/s | 15 ips<br>38.1 cm/s | 7.5 ips<br>19.05 cm/s |
|-------|---------------------|---------------------|-----------------------|
| ±2 dB | 50 Hz...20 kHz      | 30 Hz...18 kHz      | 30 Hz...10 kHz        |

**NAB Equalization**

**NAB Signal to noise ratio <sup>1</sup>:** Referred to 6 dB above operating level <sup>2</sup>unweighted noise in accordance to NAB standard.

**8/16 channel:**

|              | 30 ips<br>76.2 cm/s | 15 ips<br>38.1 cm/s | 7.5 ips<br>19.05 cm/s |
|--------------|---------------------|---------------------|-----------------------|
| record-repr: | 74 dB               | 70 dB               | 71 dB                 |
| record-sync: | 73 dB               | 70 dB               | 71 dB                 |

**24 channel:**

|              | 30 ips<br>76.2 cm/s | 15 ips<br>38.1 cm/s | 7.5 ips<br>19.05 cm/s |
|--------------|---------------------|---------------------|-----------------------|
| record-repr: | 70 dB               | 66 dB               | 67 dB                 |
| record-sync: | 68 dB               | 66 dB               | 67 dB                 |

**NAB Signal to noise ratio <sup>1</sup>:** Referred to 6 dB above operating level <sup>2</sup> weighted noise in accordance to ASA-A (IEC 179).

**8/16 channel:**

|              | 30 ips<br>76.2 cm/s | 15 ips<br>38.1 cm/s | 7.5 ips<br>19.05 cm/s |
|--------------|---------------------|---------------------|-----------------------|
| record-repr: | 77 dB               | 73 dB               | 74 dB                 |
| record-sync: | 77 dB               | 73 dB               | 74 dB                 |

**24 channel:**

|              | 30 ips<br>76.2 cm/s | 15 ips<br>38.1 cm/s | 7.5 ips<br>19.05 cm/s |
|--------------|---------------------|---------------------|-----------------------|
| record-repr: | 73 dB               | 70 dB               | 71 dB                 |
| record-sync: | 73 dB               | 70 dB               | 71 dB                 |

<sup>1</sup> measured with Ampex 456 or equivalent tape type  
<sup>2</sup> operating level (510 nWb/m tape flux)

**CCIR Equalization  
CCIR Signal to noise  
ratio <sup>3</sup>:**

linear, RMS 30 Hz ...20 kHz, operating level <sup>2</sup>.

**8/16 channel:**

|              | 30 ips<br>76.2 cm/s | 15 ips<br>38.1 cm/s | 7.5 ips<br>19.05 cm/s |
|--------------|---------------------|---------------------|-----------------------|
| record-repr: | 65 dB               | 63 dB               | 61 dB                 |
| record-sync: | 64 dB               | 63 dB               | 61 dB                 |

**24 channel:**

|              | 30 ips<br>76.2 cm/s | 15 ips<br>38.1 cm/s | 7.5 ips<br>19.05 cm/s |
|--------------|---------------------|---------------------|-----------------------|
| record-repr: | 63 dB               | 61 dB               | 59 dB                 |
| record-sync: | 61 dB               | 60 dB               | 58 dB                 |

**CCIR Sig. to noise ratio <sup>3</sup>:**

Quasi-peak, weighted noise in accordance to CCIR 4682 (DIN 45405), operating level <sup>2</sup>

**8/16 channel:**

|              | 30 ips<br>76.2 cm/s | 15 ips<br>38.1 cm/s | 7.5 ips<br>19.05 cm/s |
|--------------|---------------------|---------------------|-----------------------|
| record-repr: | 56 dB               | 53 dB               | 52 dB                 |
| record-sync: | 55 dB               | 53 dB               | 52 dB                 |

**24 channel:**

|              | 30 ips<br>76.2 cm/s | 15 ips<br>38.1 cm/s | 7.5 ips<br>19.05 cm/s |
|--------------|---------------------|---------------------|-----------------------|
| record-repr: | 54 dB               | 52 dB               | 49 dB                 |
| record-sync: | 52 dB               | 50 dB               | 48 dB                 |

**CCIR Sig. to noise ratio <sup>3</sup>:**

Referred to 6 dB above operating level <sup>2</sup> weighted noise in accordance to ASA-A (IEC 179).

**8/16 channel:**

|              | 30 ips<br>76.2 cm/s | 15 ips<br>38.1 cm/s | 7.5 ips<br>19.05 cm/s |
|--------------|---------------------|---------------------|-----------------------|
| record-repr: | 69 dB               | 67 dB               | 65 dB                 |
| record-sync: | 68 dB               | 67 dB               | 65 dB                 |

**24 channel:**

|              | 30 ips<br>76.2 cm/s | 15 ips<br>38.1 cm/s | 7.5 ips<br>19.05 cm/s |
|--------------|---------------------|---------------------|-----------------------|
| record-repr: | 67 dB               | 65 dB               | 63 dB                 |
| record-sync: | 65 dB               | 64 dB               | 62 dB                 |

<sup>2</sup> operating level (510 nWb/m tape flux)  
<sup>3</sup> measured with AGFA PEM 469 or equivalent tape type



**NRS-Option:** Bei Einsatz von NR Systemen werden die Werte für Signal to noise ratio verbessert um typisch:

|                                   | Dolby SR | Telcom c4E |
|-----------------------------------|----------|------------|
| Unweighted noise 30 Hz ... 20 kHz | 15 dB    | > 20 dB    |
| Weighted noise ASA-A              | 20 dB    | > 20 dB    |
| Weighted noise CCIR 468-II        | 20 dB    | > 20 dB    |

**Distortion <sup>1</sup>:** At 1 kHz (3rd harmonic) and 510 nWb/m tape flux:

| 30 ips<br>76.2 cm/s | 15 ips<br>38.1 cm/s | 7.5 ips<br>19.05 cm/s |
|---------------------|---------------------|-----------------------|
| 1% max.             | 1% max.             | 1% max.               |

**Crosstalk rejection <sup>2</sup>:** Between adjacent tracks at 15 ips (jumper narrow):

- 8/16 channel
  - Reproduce mode:  $\geq 40$  dB (80 Hz ... 12 kHz)
  - Sync mode:  $\geq 20$  dB at 1 kHz  
 $\geq 8$  dB at 10 kHz
- 24 channel:
  - Reproduce mode:  $\geq 40$  dB (100 Hz ... 12 kHz)
  - Sync mode:  $\geq 20$  dB at 1 kHz  
 $\geq 10$  dB at 10 kHz

**Erase efficiency:** 15 ips, 510 nWb/m  $\geq 75$  dB at 1kHz

**Erase frequency:** 153.6 kHz

**Bias frequency:** 153.6 kHz

**Power requirements:** 110 V or 220 V  $\pm 10\%$ , 50 ... 60 Hz

**Power consumption:** 1'100 VA max.

**Safety standard:** according to IEC-Standard, Publication 65, Apparatus Class I

<sup>1</sup> measured with Ampex 456 or equivalent tape type  
<sup>2</sup> operating level (510 nWb/m tape flux)

1.7 Standard Calibration Data

These data are values that are transferred from the ROM into the RAM of the AUDIO MPU and the latches of the audio amplifiers in the event that the RAM data are lost. These values ensure that the recorder can still be used despite this loss of data, albeit possibly with a minor degradation in audio quality. They are not intended as a substitute for individual calibration through which component and manufacturing tolerances can be compensated.

The data are represented as hexadecimal numbers, i.e. in the same form as they appear on the service display.

These data apply to Peak level (+6 VU / 0 dB PPM), 510 nWb/m and tape types 3M 226 (NAB) and Agfa PEM 469 (CCIR).

24 CH Headblock:

| Speed | Mode   | Equal. | Level | Treble | Bass | Equal. |
|-------|--------|--------|-------|--------|------|--------|
| 7.5   | REPRO  | CCIR   | 90    | 70     | A0   | 7C     |
| 7.5   | RECORD | CCIR   | 20    | 50     | 26   | AA     |
| 7.5   | SYNC   | CCIR   | 90    | 88     | A0   | 97     |
| 7.5   | REPRO  | NAB    | 90    | 70     | A0   | 69     |
| 7.5   | RECORD | NAB    | 20    | 50     | 26   | B8     |
| 7.5   | SYNC   | NAB    | 90    | 88     | A0   | 85     |
| 15    | REPRO  | CCIR   | 90    | 38     | 90   | 4F     |
| 15    | RECORD | CCIR   | 20    | 48     | 29   | C0     |
| 15    | SYNC   | CCIR   | 90    | 90     | 90   | 58     |
| 15    | REPRO  | NAB    | 90    | 38     | 90   | 69     |
| 15    | RECORD | NAB    | 20    | 48     | 29   | AA     |
| 15    | SYNC   | NAB    | 90    | 90     | 90   | 79     |
| 30    | REPRO  |        | 88    | 30     | 80   | 2C     |
| 30    | RECORD |        | 20    | 1C     | 30   | D3     |
| 30    | SYNC   |        | 90    | 90     | 80   | 2C     |

16 CH Headblock:

| Speed | Mode   | Equal. | Level | Treble | Bass | Equal. |
|-------|--------|--------|-------|--------|------|--------|
| 7.5   | REPRO  | CCIR   | 58    | 58     | A4   | 7C     |
| 7.5   | RECORD | CCIR   | 20    | 50     | 26   | A2     |
| 7.5   | SYNC   | CCIR   | 68    | 38     | B4   | 7C     |
| 7.5   | REPRO  | NAB    | 58    | 58     | A4   | 69     |
| 7.5   | RECORD | NAB    | 20    | 50     | 26   | A9     |
| 7.5   | SYNC   | NAB    | 68    | 38     | B4   | 69     |
| 15    | REPRO  | CCIR   | 58    | 28     | A0   | 44     |
| 15    | RECORD | CCIR   | 22    | 50     | 30   | BA     |
| 15    | SYNC   | CCIR   | 70    | 38     | A8   | 44     |
| 15    | REPRO  | NAB    | 58    | 28     | A0   | 61     |
| 15    | RECORD | NAB    | 22    | 50     | 30   | 99     |
| 15    | SYNC   | NAB    | 70    | 38     | A8   | 61     |
| 30    | REPRO  |        | 52    | 24     | 88   | 26     |
| 30    | RECORD |        | 28    | 26     | 36   | D3     |
| 30    | SYNC   |        | 68    | 38     | 80   | 26     |

8 CH Headblock:

| Speed | Mode   | Equal. | Level | Treble | Bass | Equal. |
|-------|--------|--------|-------|--------|------|--------|
| 7.5   | REPRO  | CCIR   | 58    | 58     | A4   | 7C     |
| 7.5   | RECORD | CCIR   | 20    | 50     | 26   | A2     |
| 7.5   | SYNC   | CCIR   | 68    | 38     | B4   | 7C     |
| 7.5   | REPRO  | NAB    | 58    | 58     | A4   | 69     |
| 7.5   | RECORD | NAB    | 20    | 50     | 26   | A9     |
| 7.5   | SYNC   | NAB    | 68    | 38     | B4   | 69     |
| 15    | REPRO  | CCIR   | 58    | 28     | A0   | 44     |
| 15    | RECORD | CCIR   | 22    | 50     | 30   | BA     |
| 15    | SYNC   | CCIR   | 70    | 38     | A8   | 44     |
| 15    | REPRO  | NAB    | 58    | 28     | A0   | 61     |
| 15    | RECORD | NAB    | 22    | 50     | 30   | 99     |
| 15    | SYNC   | NAB    | 70    | 38     | A8   | 61     |
| 30    | REPRO  |        | 52    | 24     | 88   | 26     |
| 30    | RECORD |        | 28    | 26     | 36   | D3     |
| 30    | SYNC   |        | 68    | 38     | 80   | 26     |

## 2. Installation, Operating

|        |  |    |
|--------|--|----|
| 2.1    | Unpacking and Testing.....   | 1  |
| 2.2    | Installation Site .....  | 1  |
| 2.3    | Connections.....   | 2  |
| 2.3.1  | Mains Connection, Line Voltage Selector .....                        | 3  |
| 2.3.2  | Line Input and Output.....   | 4  |
| 2.3.3  | Remote Control Connectors .....                                      | 4  |
| 2.3.4  | Audio Remote Connector (serial) .....                                | 9  |
| 2.3.5  | Parallel Channel Remote Control Interface.....                       | 10 |
| 2.3.6  | Control Connectors of the Noise Reduction System .....               | 12 |
| 2.3.7  | Autolocator/Remote Timer Connector .....                             | 12 |
| 2.3.8  | VU-Meter Panel Connector.....  | 13 |
| 2.4    | Operating Instructions .....   | 14 |
| 2.4.1  | Power Switch.....  | 15 |
| 2.4.2  | Control Keys.....  | 16 |
| 2.4.3  | VU-Meter Panel.....  | 19 |
| 2.4.4  | Channel Selector Keys .....  | 20 |
| 2.4.5  | Audio Mode Selectors .....   | 21 |
| 2.4.6  | Metering and Audio Generator .....                                   | 23 |
| 2.5    | Operation .....  | 24 |
| 2.5.1  | Pilot Lamps .....  | 24 |
| 2.5.2  | Threading the Tape .....   | 25 |
| 2.5.3  | Tape Speeds.....   | 25 |
| 2.5.4  | Play Mode.....   | 25 |
| 2.5.5  | Reverse Play Mode .....  | 25 |
| 2.5.6  | Varispeed Control .....  | 26 |
| 2.5.7  | Record Mode.....   | 26 |
| 2.5.8  | Sync Reproduction .....  | 27 |
| 2.5.9  | Wind Mode .....  | 27 |
| 2.5.10 | Producing Pancakes at Reduced Spooling Speeds,<br>Library Wind ..... | 28 |
| 2.5.11 | Stop Mode .....  | 28 |
| 2.5.12 | Editing, Cutting the Tape .....                                      | 28 |
| 2.5.13 | Tape Dump Mode .....   | 29 |
| 2.5.14 | Locator .....  | 31 |
| 2.5.15 | Tape Timer.....  | 31 |
| 2.5.16 | Auxiliary Tape Timer .....   | 32 |
| 2.5.17 | Remote Control .....   | 32 |
| 2.5.18 | Time Code Channel (Option).....                                      | 33 |
| 2.6    | Soft Keys, Status Tree Diagram for A820 MCH 1" and 2" Version.....   | 35 |
| 2.6.1  | Key Numbering .....  | 37 |
| 2.6.2  | Description of the Functions .....                                   | 37 |
| 2.6.3  | Programming Examples .....   | 48 |
| 2.6.4  | How to perform a software up-date .....                              | 51 |
| 2.7    | Degraded Operation .....   | 52 |
| 2.7.1  | Error Messages of the Service Display .....                          | 52 |
| 2.7.2  | Additional Messages of the Service Display (Warnings) .....          | 58 |
| 2.8    | Operation with Serial Interfaces .....                               | 59 |
| 2.8.1  | RS 232 and RS 422 Interface Standard .....                           | 59 |
| 2.8.2  | Installation of the Serial Remote Controller 1.810.751 .....         | 61 |
| 2.8.3  | Installation of the SMPTE/EBU-Interface 1.820.751 .....              | 67 |
| 2.9    | Care Instructions .....  | 71 |

## 2. Installation, Operating

---

---

### 2.1 Unpacking and Testing

---

---

The A820 MCH tape recorder is delivered in a special packing that protects it from damage in transit. Care should be exercised when unpacking the recorder so that the equipment surfaces will not become marred.

Compare the content with the packing slip to ensure that the equipment is complete. Save the original packing material because it provides the best protection for your recorder for subsequent shipment.

Examine the complete content for possible shipping damage. The shipping company and the nearest STUDER dealer should be notified immediately in the event of damage.

### 2.2 Installation Site

---

---

The A820 MCH tape recorder should be installed in a dust-free, well ventilated location. The recorder specifications are guaranteed for ambient temperatures ranging from 0 to 40°C. The relative humidity (non condensing) should range between 20 and 90%.

Install the recorder in a place where there is sufficient space for unobstructed ventilation. Localization of heat can occur when the recorder is installed in a recess. The air circulation zone should not be used as a storage area for manuals etc. when the recorder is being used.

The recorder should not be placed in close proximity to strong electromagnetic fields. General sources of interference are: strong load fluctuations on adjacent power lines, high-power transformers, elevator motors, as well as nearby radio and television transmitters.

The back of the recorder should remain accessible for maintenance purposes. If the recorder is installed in a recess, sufficient clearance for shifting the recorder should remain also when the cables are attached.

2.3 Connections

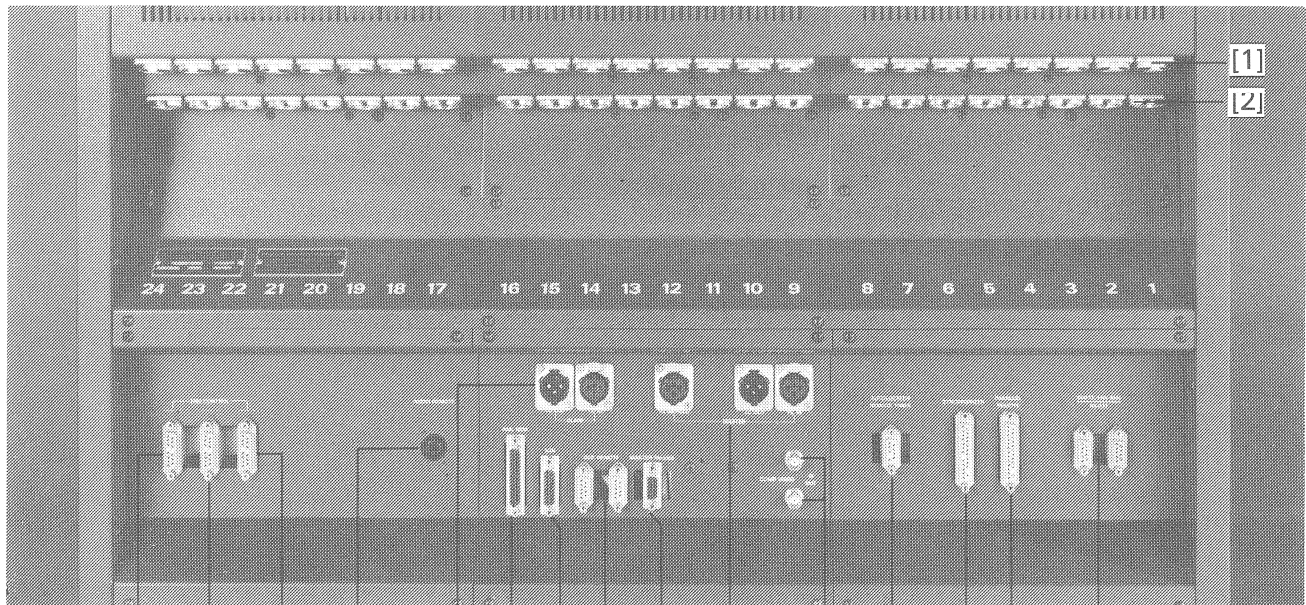

Fig. 2.3

- [17]
- [16]
- [15]
- [14]
- [13]
- [12]
- [11]
- [10]
- [9]
- [8]
- [7]
- [6]
- [5]
- [4]
- [3]

- [1] Audio inputs
  - [2] Audio outputs
  - [3] Serial connector. The two connectors are parallel for SMPTE/EBU bus, RS 232 interface (Option)
  - [4] Parallel remote
  - [5] Synchronizer
  - [6] Autolocator / Remote timer / Serial remote controller
  - [7] Composite video IN/OUT
  - [8] Time code Master IN/OUT
  - [9] Master tallies
  - [10] Serial remote
  - [11] LCU
  - [12] Parallel remote
  - [13] Time code Slave IN/OUT
  - [14] Audio remote (Option)
  - [15] NRS control channels 1 .. 8
  - [16] NRS control channels 9 .. 16
  - [17] NRS control channels 17 .. 24
- } Option (20.820.395.00)

## 2.3.1 Mains Connection, Line Voltage Selector

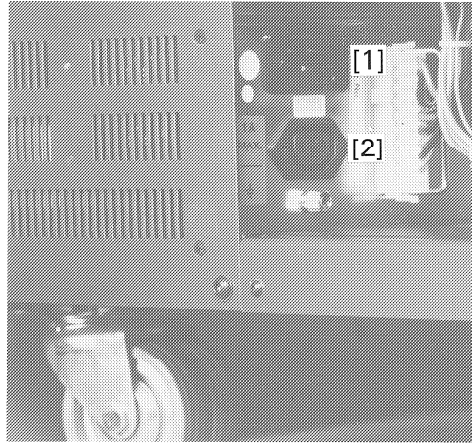

Fig. 2.3.1 1 [1] Main connector  
[2] Power connector for TLS 4000

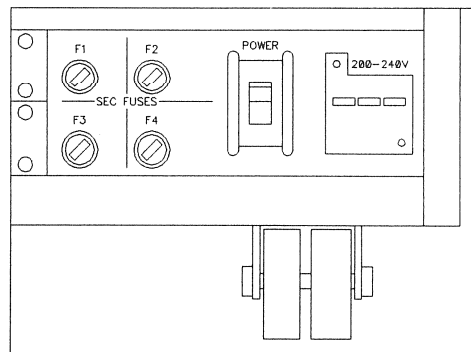

Fig. 2.3.1-2 Line voltage selector

**Caution** Before the recorder is connected for the first time, verify that the setting of the voltage selector on the front of the recorder matches the local line voltage. The following line voltages can be selected:  
100 ... 140 or 200 ... 240 VAC,  $\pm 10\%$ .  
Disconnect the recorder from the AC supply before you change the voltage selector setting! Unfasten the cover of the voltage selector (2 screws, Allen key No. 2.5), change over three switches and reinstall the cover, rotated by 180°.

## 2.3.2 Line Input and Output

---

The balanced inputs and outputs are terminated on XLR male or female sockets (described in the IEC recommendation 268-14).

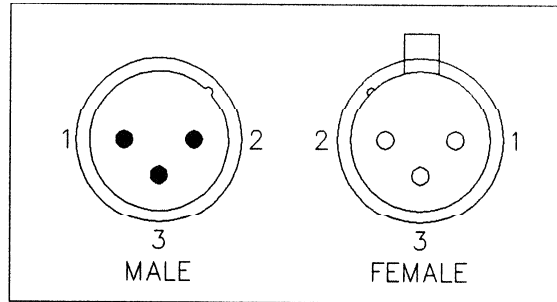

Fig. 2.3.2 [1] = Audio ground  
[2] = A-line (hot)  
[3] = B-line (cold)  
1 The A-line is hot if the recorder is connected to an unbalanced source.

## 2.3.3 Remote Control Connectors

---

### Parallel remote control connector

A parallel remote control unit with the following features can be interfaced via this 25-pin connector (female, D-type):

- Remote control of the tape deck functions with feedback (◀, ▶, PLAY, STOP, and REC)
- RESET TIMER (resets the tape counter)
- ZERO LOC (automatically searches the tape counter address 0.00.00.0)
- LOC START (automatically searches the tape counter address at which the last PLAY command was entered)
- LIFTER (cancels the tape lifting during spooling for as long as this key is pressed)
- FADER (enables the fader start circuit)
- VARISPEED (variable tape speed)



Pin assignment of the PARALLEL REMOTE CONTROL connector:

| Pin | Signal name | Designation   |
|-----|-------------|---|
| 01  | +0.0        | Ground  |
| 02  | BR-REW *    | Pilot lamp, REWIND  |
| 03  | BR-FORW *   | Pilot lamp, FORWARD   |
| 04  | BR-VRSPD *  | Pilot lamp, VARISPEED (alternatingly HIGH and LOW when active)  |
| 05  | SR-VRSPD +  | Switch for VARISPEED command  |
| 06  | SR-FADRY +  | Switch for FADER START READY command  |
| 07  | BR-LOCST *  | Pilot lamp, LOC START   |
| 08  | BR-FADRY *  | Pilot lamp, FADER START READY   |
| 09  | BR-REC *    | Pilot lamp, RECORD  |
| 10  | SR-RESET +  | Switch for RESET TIMER command  |
| 11  | FAD1        | Input FADER START command, line A   |
| 12  | FAD2        | Input FADER START command, line B<br>(FADER START active if 5..24 VAC or DC are present between pins 11 and 12) |
| 13  | TR-REFEX    | Input for external capstan PLL reference (nominal 9,6 kHz, TTL level recommended; maximum input voltage +12 V)  |
| 14  | SR-OLOC +   | Switch for ZERO LOC command   |
| 15  | BR-PLAY *   | Pilot lamp, PLAY  |
| 16  | BR-STOP *   | Pilot lamp, STOP  |
| 17  | SR-LIFT +   | Switch for LIFTER command   |
| 18  | SR-LOCST +  | Switch for LOC START command  |
| 19  | SR-REC +    | Switch for RECORD command   |
| 20  | SR-REW +    | Switch for REWIND command   |
| 21  | SR-FORW +   | Switch for FORWARD command  |
| 22  | SR-PLAY +   | Switch for PLAY command   |
| 23  | SR-STOP +   | Switch for STOP command   |
| 24  | KEY         | Coding  |
| 25  | +24.0       | +24 V supply (max. 300 mA)  |

- \* Open collector output active LOW. No internal pull-up resistor, max. HIGH level = +30 V. Max. load current 200 mA, internal current limiting resistor 22  $\Omega$ .
- + Switch input, LOW level activates the command. Internal pull-up resistor 4.7 k $\Omega$  connected to +24 V supply, max. HIGH input level = +30 V, logic level: LOW = 0..+4 V, HIGH = +7.5..+30 V.

Order Number

|                           |               |
|---------------------------|---------------|
| Connector complete        | 20.020.303.16 |
| Connector housing, 25-pin | 54.13.7022    |
| Connector, 25-pin, coded  | 10.217.001.06 |

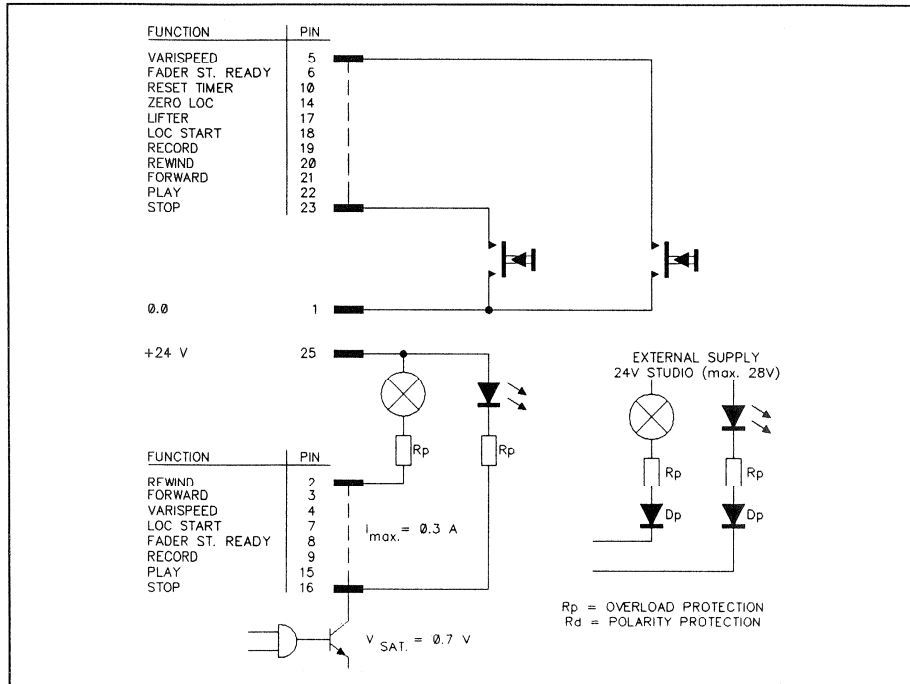

Fig. 2.3.3-1 Remote control circuit

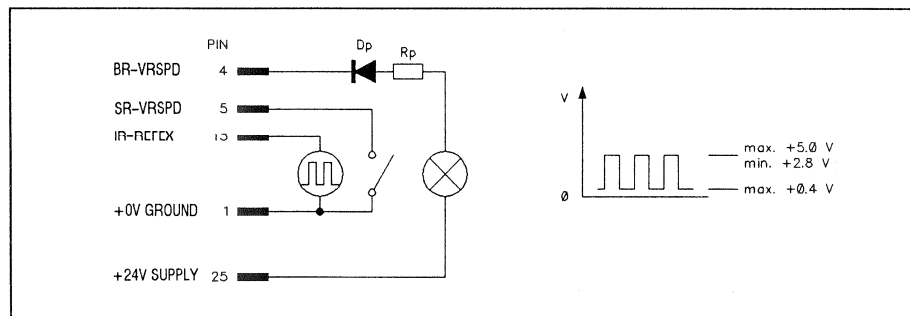

Fig. 2.3.3-2 Varispeed circuit

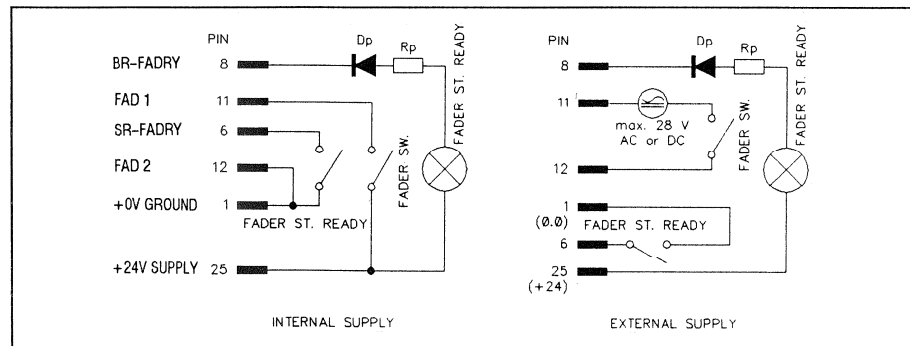

Fig. 2.3.3-3 Fader start circuit

**Caution!** If light bulbs are used as pilot lamps, their inrush current should not exceed 0.3 A.

**External synchronizer connector**

An external synchronizer with the following facilities can be connected to this 25-pin connector (female, D-type):

Pin assignment of the EXTERNAL SYNCHRONIZER connector:

| Pin | Signal name | Designation  |
|-----|-------------|--|
| 01  | +0.0        | Ground   |
| 02  | BR-REW *    | Pilot lamp, REWIND   |
| 03  | BR-FORW *   | Pilot lamp, FORWARD  |
| 04  | BR-VRSPD *  | Pilot lamp, VARISPEED (alternatingly HIGH and LOW when active)   |
| 05  | SR-VRSPD +  | Switch for VARISPEED command   |
| 06  | SR-REHSL +  | Switch for REHEARSAL command   |
| 07  | OR-MVCLK *  | Output for TAPE MOVE CLOCK signal (512 pulses/15 inch, pulse duty factor 50%)                                    |
| 08  | KEY         | Coding   |
| 09  | BR-REC *    | Pilot lamp RECORD  |
| 10  | OR-MVDIR *  | Output for TAPE MOVE DIRECTION signal (rewind = LOW, forward = HIGH)   |
| 11  | OR-CMCLK *  | Output for CAPSTAN M. MOVE CLOCK signal (1200 impulses/sec at 7.5 ips)   |
| 12  | OR-SYENB    | Output for SYNCHRONIZER ENABLE signal (LOW if tape is threaded and recorder ready; HIGH when tape not tensioned) |
| 13  | IR-REFEX    | Input for external capstan PLL reference (nominal 9.6 kHz, TTL level recommended; max. input voltage = +30 V)    |
| 14  | +0.0        | Ground   |
| 15  | BR-PLAY *   | Pilot lamp, PLAY   |
| 16  | BR-STOP *   | Pilot lamp, STOP   |
| 17  | SR-LIFT +   | Switch for LIFTER command  |
| 18  | SR-MUTE +   | Switch for MUTE command (no influence on TC channel)   |
| 19  | SR-REC +    | Switch for RECORD command  |
| 20  | SR-REW +    | Switch for REWIND command  |
| 21  | SR-FORW +   | Switch for FORWARD command   |
| 22  | SR-PLAY +   | Switch for PLAY command  |
| 23  | SR-STOP +   | Switch for STOP command  |
| 24  | KEY         | Coding   |
| 25  | +24.0       | +24 V supply (max. 300 mA)   |

- \* Open collector output active LOW. No internal pull-up resistor, max. HIGH level = +30 V. Max. load current 200 mA, internal current limiting resistor 22 Ω.
- + Switch input, LOW level activates the command. Internal pull-up resistor 4.7 kΩ connected to +24 V supply, max. HIGH input level = +30 V, logic level: LOW = 0..+4 V, HIGH = +7.5..+30 V.

Order Number

|                           |               |
|---------------------------|---------------|
| Connector complete        | 20.020.303.15 |
| Connector housing, 25-pin | 54.13.7022    |
| Connector, 25-pin, coded  | 10.217.001.05 |

**Connector for RS232C interface (binary protocol) and SMPTE/EBU bus or RS232C interface (ASCII protocol)**

The following can be connected to this 9-pin (female, D-type) connector:  
 A terminal with RS232C interface (ASCII protocol) or a TLS 4000 (via the serial remote controller 1.810.751, option 20.820.393.00)

- or a terminal with RS232C interface (binary protocol) or the SMPTE/EBU bus (RS422) via the SMPTE/EBU interface 1.820.751, (option 20.820.394.00).

Option 1.820.751

- Pin assignment of the RS232&SMPTE/EBU connectors.  
(9 Pin D-type)

| RS422 (SMPTE/EBU-Protocol) |                 |
|----------------------------|-----------------|
| Pin                        | signal name     |
| 01                         | Shield          |
| 02                         | Transmit A      |
| 03                         | Receive B       |
| 04                         | Receive Common  |
| 05                         | ---             |
| 06                         | Transmit Common |
| 07                         | Transmit B      |
| 08                         | Receive A       |
| 09                         | Shield          |

| RS 422 (SMPTE/EBU Protocol) |                  |
|-----------------------------|------------------|
| Pin                         | signal name      |
| 01                          | SHIELD           |
| 02                          | ---              |
| 03                          | RX Receive Data  |
| 04                          | 0V Ground        |
| 05                          | ---              |
| 06                          | 0V Ground .....  |
| 07                          | TX Transmit Data |
| 08                          | ---              |
| 09                          | Shield           |

- SMPTE/EBU application with \*NRZ-format.

Option 1.810.751

- Pin assignment of the RS232&SMPTE/EBU connectors.  
(9 Pin D-type)

| RS232 (ASCII-Protocol) |                  |
|------------------------|------------------|
| Pin                    | signal name      |
| 01                     | ---              |
| 02                     | TX Transmit Data |
| 03                     | ---              |
| 04                     | ---              |
| 05                     | ---              |
| 06                     | ---              |
| 07                     | ---              |
| 08                     | RX Receive Data  |
| 09                     | 0V Ground        |

| RS 232 (ASCII-Protocol) |                  |
|-------------------------|------------------|
| Pin                     | signal name      |
| 01                      | 0V Ground        |
| 02                      | ---              |
| 03                      | ---              |
| 04                      | RX Receive Data  |
| 05                      | ---              |
| 06                      | TX Transmit Data |
| 07                      | ---              |
| 08                      | ---              |
| 09                      | ---              |

- normal RS 232 application with \*NRZ-format.

- normal RS 232 application but with \*Bi-Phase format.

Communication Controller

- Pin assignment of the Communication Controller.  
(9 Pin D-type)

| RS232 (ASCII-Protocol) |                  |
|------------------------|------------------|
| Pin                    | signal name      |
| 01                     | 0V Ground        |
| 02                     | TX Transmit Data |
| 03                     | ---              |
| 04                     | ---              |
| 05                     | ---              |
| 06                     | ---              |
| 07                     | ---              |
| 08                     | RX Receive Data  |
| 09                     | ---              |

| RS 232 (ASCII-Protocol) |              |
|-------------------------|--------------|
| Pin                     | signal name  |
| 01                      | 0V Ground    |
| 02                      | ---          |
| 03                      | Receive Data |
| 04                      | ---          |
| 05                      | ---          |
| 06                      | ---          |
| 07                      | Send Data    |
| 08                      | ---          |
| 09                      | ---          |

- Save datas on a PC with \*NRZ-format.

- Save datas on tape with \*Bi-Phase-format.

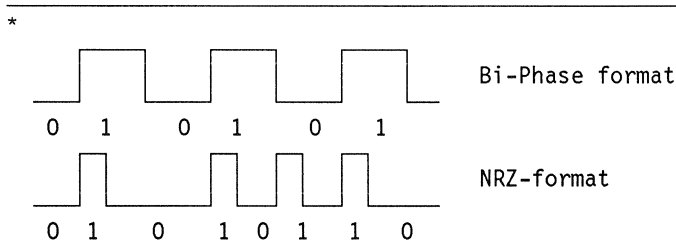

### 2.3.4 Audio Remote Connector (serial)

A channel remote control module (Part No. 21.328.501.00 for 8-channel machines, 21.328.503.00 for 16- und 24-channel machines) can be interfaced via the serial AUDIO REMOTE connector (Neutrik, 8-pin).

Pin assignment of the AUDIO REMOTE connector

| Pin | Signal name | Conn. cable wire color |
|-----|-------------|------------------------|
| 1   | OSTABIN     | screen                 |
| 2   | OSTABIN     | blue                   |
| 3   | OSTABIN     | violet                 |
| 4   | +STABIN4    | red                    |
| 5   | +STABIN4    | yellow                 |
| 6   | +STABIN4    | brown                  |
| 7   | PNLBUS1     | white                  |
| 8   | PNLBUS2     | black                  |

Order Number

**Connector, complete:**  
**Cable**

Neutrik, 8-pin, male  
screened, 10 x 0.14 mm<sup>2</sup>

20.020.303.23

64.03.0149

If problems occur with cables longer than 50 m, a termination resistor can be connected between pins 7 and 8 at both cable ends. Typical rating (depending on cable resistance): 220 ohms ¼ W. Max. cable length 100 m.

### 2.3.5 Parallel Channel Remote Control Interface

A parallel channel remote control device of a mixing console can be connected via the PARALLEL AUDIO CHANNEL CONTROL INTERFACE (Order No. 21.328.500.00) to the serial AUDIO REMOTE connector of the A820 MCH tape recorder. The pin assignment of the AUDIO REMOTE connector is described in Section 2.3.4.

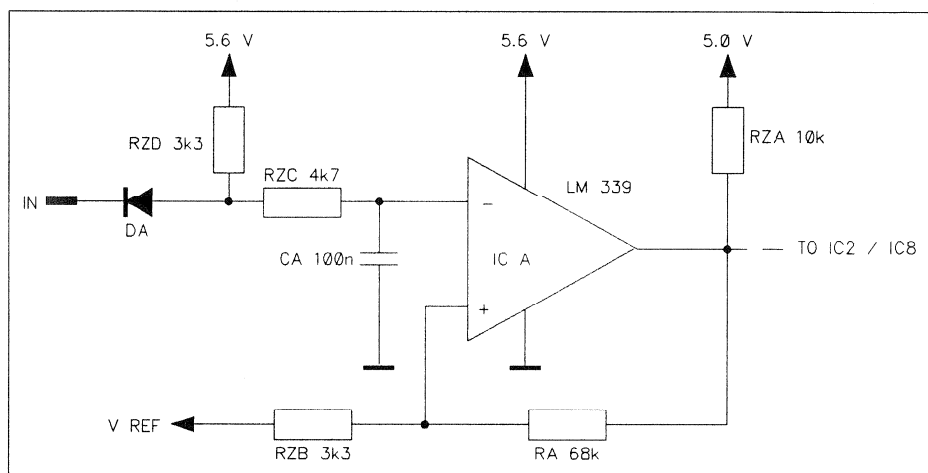

Fig. 2.3.5-1 Input circuit

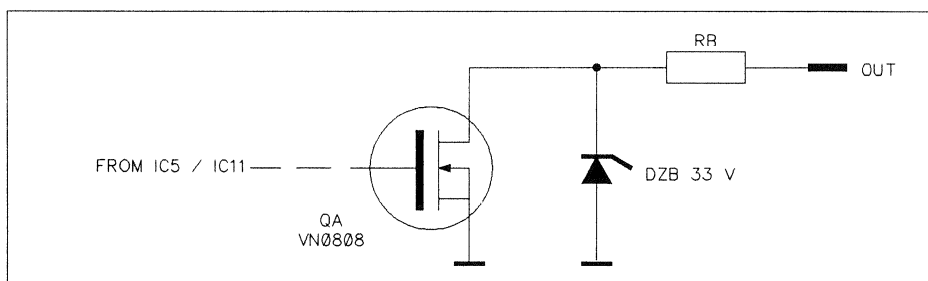

Fig. 2.3.5-2 Output circuit

Connector Configuration:

| AUDIO CHANNELS 1...8 |           |        | AUDIO CHANNELS 9...16 |           |       | AUDIO CHANNELS 17..24 |           |       |
|----------------------|-----------|--------|-----------------------|-----------|-------|-----------------------|-----------|-------|
| D-type 78-pin POINT  | SIG. NAME | COLOR  | D-type 78-pin POINT   | SIG. NAME | COLOR | D-type 78-pin POINT   | SIG. NAME | COLOR |
| 1                    | S-REA-01  | br     | 1                     | S-REA-09  | br    | 1                     | S-REA-17  | br    |
| 2                    | S-REA-02  | rt     | 2                     | S-REA-10  | rt    | 2                     | S-REA-18  | rt    |
| 3                    | S-REA-03  | or     | 3                     | S-REA-11  | or    | 3                     | S-REA-19  | or    |
| 4                    | S-REA-04  | rt     | 4                     | S-REA-12  | rt    | 4                     | S-REA-20  | rt    |
| 5                    | S-REA-05  | gn     | 5                     | S-REA-13  | gn    | 5                     | S-REA-21  | gn    |
| 6                    | S-REA-06  | rt     | 6                     | S-REA-14  | rt    | 6                     | S-REA-22  | rt    |
| 7                    | S-REA-07  | bl     | 7                     | S-REA-15  | bl    | 7                     | S-REA-23  | bl    |
| 8                    | S-REA-08  | rt     | 8                     | S-REA-16  | rt    | 8                     | S-REA-24  | rt    |
| 25                   | B-REA-01  | br     | 25                    | B-REA-09  | br    | 25                    | B-REA-17  | br    |
| 26                   | B-REA-02  | sw     | 26                    | B-REA-10  | sw    | 26                    | B-REA-18  | sw    |
| 27                   | B-REA-03  | or     | 27                    | B-REA-11  | or    | 27                    | B-REA-19  | or    |
| 28                   | B-REA-04  | sw     | 28                    | B-REA-12  | sw    | 28                    | B-REA-20  | sw    |
| 29                   | B-REA-05  | gn     | 29                    | B-REA-13  | gn    | 29                    | B-REA-21  | gn    |
| 30                   | B-REA-06  | sw     | 30                    | B-REA-14  | sw    | 30                    | B-REA-22  | sw    |
| 31                   | B-REA-07  | bl     | 31                    | B-REA-15  | bl    | 31                    | B-REA-23  | bl    |
| 32                   | B-REA-08  | sw     | 32                    | B-REA-16  | sw    | 32                    | B-REA-24  | sw    |
| 33                   | B-RCD-01  | br     | 33                    | B-RCD-09  | br    | 33                    | B-RCD-17  | br    |
| 34                   | B-RCD-02  | rt     | 34                    | B-RCD-10  | rt    | 34                    | B-RCD-18  | rt    |
| 35                   | B-RCD-03  | or     | 35                    | B-RCD-11  | or    | 35                    | B-RCD-19  | or    |
| 36                   | B-RCD-04  | rt     | 36                    | B-RCD-12  | rt    | 36                    | B-RCD-20  | rt    |
| 37                   | B-RCD-05  | gn     | 37                    | B-RCD-13  | gn    | 37                    | B-RCD-21  | gn    |
| 38                   | B-RCD-06  | rt     | 38                    | B-RCD-14  | rt    | 38                    | B-RCD-22  | rt    |
| 39                   | B-RCD-07  | bl     | 39                    | B-RCD-15  | bl    | 39                    | B-RCD-23  | bl    |
| 40                   | B-RCD-08  | rt     | 40                    | B-RCD-16  | rt    | 40                    | B-RCD-24  | rt    |
| 53                   | 0.0-DIG   | or     | 53                    | 0.0-DIG   | sw    | 53                    | 0.0-DIG   | sw    |
| 54                   | +5.0-A    | or     | 54                    | +5.0-B    | or    | 54                    | +5.0-C    | or    |
| 55                   | B-RES1    |        |                       |           |       |                       |           |       |
| 56                   | S-REMIN   | sw     | 56                    | S-REMIN   | sw    | 56                    | S-REMIN   | sw    |
| 57                   | B-RES2    |        |                       |           |       |                       |           |       |
| 58                   | B-RES3    |        |                       |           |       |                       |           |       |
| 59                   | B-INPM    | Note 1 |                       |           |       |                       |           |       |
| 60                   | B-SYNM    | Note 2 |                       |           |       |                       |           |       |
| 61                   | B-REPM    | Note 3 |                       |           |       |                       |           |       |
| 62                   | B-REMENB  | Note 4 |                       |           |       |                       |           |       |
| 63                   | B-M.SAFE  | Note 5 |                       |           |       |                       |           |       |
| 64                   | B-RES4    |        |                       |           |       |                       |           |       |
| 65                   | S-RES2    |        |                       |           |       |                       |           |       |
| 66                   | S-RES3    |        |                       |           |       |                       |           |       |
| 67                   | S-REMENB  | Note 6 |                       |           |       |                       |           |       |
| 68                   | S-M.SAFE  | Note 7 |                       |           |       |                       |           |       |
| 69                   | S-RES1    |        |                       |           |       |                       |           |       |
| 71                   | S-REPM    | Note 8 |                       |           |       |                       |           |       |
| 72                   | S-RES4    | or     |                       |           |       |                       |           |       |
| 73                   | S-INPM    | Note 9 |                       |           |       |                       |           |       |
| 76                   | KEY       |        | 76                    | KEY       |       | 76                    | KEY       |       |
| 77                   | KEY       |        | 77                    | KEY       |       | 77                    | KEY       |       |

Notes:

- 1: ON if switch S-INPM closed
- 2: ON if switch S-REPM not closed
- 3: ON if switch S-REPM closed
- 4: ON if parallel inputs active
- 5: ON if switch S-M.SAFE closed
- 6: Pulse input (flip-flop) interlocked with tape transport key (if available)
- 7: When this switch is closed, READY can no longer be selected or the READY function can no longer be activated (conductor color: red).
- 8: Switch open: M-SYNC, Switch closed: M-REP (conductor color: brown).
- 9: If switch closed: input with highest priority

### 2.3.6 Control Connectors of the Noise Reduction System

Noise reduction systems can be interfaced via the control connectors of the noise reduction system (one connector for 8 channels). The encode/decode changeover is controlled via these connectors.

Connector configuration:

| CHANNELS 1...8 |                  |       | CHANNELS 9...16 |                  |       | CHANNELS 17...24 |                  |       |
|----------------|------------------|-------|-----------------|------------------|-------|------------------|------------------|-------|
| D-type POINT   | 15-pin SIG. NAME | COLOR | D-type POINT    | 15-pin SIG. NAME | COLOR | D-type POINT     | 15-pin SIG. NAME | COLOR |
| 1              | B-RCD-01         | br    | 1               | B-RCD-09         | br    | 1                | B-RCD-17         | br    |
| 2              | B-RCD-02         | rt    | 2               | B-RCD-10         | rt    | 2                | B-RCD-18         | rt    |
| 3              | B-RCD-03         | or    | 3               | B-RCD-11         | or    | 3                | B-RCD-19         | or    |
| 4              | KEY              |       | 4               | KEY              |       | 4                | KEY              |       |
| 5              | B-RCD-04         | rt    | 5               | B-RCD-12         | rt    | 5                | B-RCD-20         | rt    |
| 6              | B-RCD-05         | gn    | 6               | B-RCD-13         | gn    | 6                | B-RCD-21         | gn    |
| 7              |                  |       | 7               |                  |       | 7                |                  |       |
| 8              |                  |       | 8               |                  |       | 8                |                  |       |
| 9              |                  |       | 9               |                  |       | 9                |                  |       |
| 10             | B-RCD-06         | rt    | 10              | B-RCD-14         | rt    | 10               | B-RCD-22         | rt    |
| 11             | B-RCD-07         | bl    | 11              | B-RCD-15         | bl    | 11               | B-RCD-23         | bl    |
| 12             | KEY              |       | 12              | KEY              |       | 12               | KEY              |       |
| 13             | B-RCD-08         | rt    | 13              | B-RCD-16         | rt    | 13               | B-RCD-24         | rt    |
| 14             | +24.0            | br    | 14              | +24.0            | br    | 14               | +24.0            | br    |
| 15             | 0.0-DIG-A        | sw    | 15              | 0.0-DIG-B        | sw    | 15               | 0.0-DIG-C        | sw    |

Order Number

Connector, complete

D-type, 15-pin, male, screw-on

20.020.303.08

### 2.3.7 Autolocator/Remote Timer Connector

A serial remote control, a remote counter, or an autolocator can be connected via this 9-pin connector (female, D-type).

The keys of the serial remote control can be programmed by the user as desired. All functions available on the local keyboard can also be executed from the remote control. The functions programmed for the serial remote control do not necessarily have to be the same as those of the local keyboard.

Pin assignment of the AUTOLOCATOR/REMOTE TIMER connector:

| Pin | Signal name | Conn. cable wire color |
|-----|-------------|------------------------|
| 1   | SHIELD      | screen                 |
| 2   | N.C.        | ---                    |
| 3   | TR-A        | green                  |
| 4   | KEY         | ---                    |
| 5   | +0.0        | grey                   |
| 6   | N.C.        | ---                    |
| 7   | TR-B        | blue                   |
| 8   | SIG.GND     | red                    |
| 9   | +REMSUP     | black                  |



|                             |   | Order Number  |
|-----------------------------|---|---------------|
| <b>Connector, complete:</b> | D-type, 9-pin, male, solderable, for cable end at the machine | 20.020.303.20 |
|                             | D-type, 9-pin, female, solderable, for remote cable end       | 20.020.303.21 |
|                             | Cable: screened, 10 x 0.14 mm <sup>2</sup>                    | 64.03.0149    |

### 2.3.8 VU-Meter Panel Connector

The panel with the VU-meters can be connected to the tape recorder via the serial VU-METER PANEL connector (Neutrik, 8-pin).

Pin assignment of the VU-METER PANEL connector

| Pin | Signal name | Conn. cable wire color |
|-----|-------------|------------------------|
| 1   | OSTABIN     | screen                 |
| 2   | OSTABIN     | blue                   |
| 3   | OSTABIN     | violet                 |
| 4   | +STABIN4    | red                    |
| 5   | +STABIN4    | yellow                 |
| 6   | +STABIN4    | brown                  |
| 7   | PNLBUS1     | white                  |
| 8   | PNLBUS2     | black                  |

|                             |  | Order Number  |
|-----------------------------|--|---------------|
| <b>Connector, complete:</b> | Neutrik, 8-pin, male                       | 20.020.303.23 |
|                             | Neutrik, 8-pin, female                     | 20.020.303.24 |
|                             | Cable: screened, 10 x 0.14 mm <sup>2</sup> | 64.03.0149    |

If problems occur with cables longer than 50 m, a termination resistor can be inserted between pins 7 and 8 at both cable ends. Typical rating (depending on cable resistance): 220 ohm ¼ W, max. cable length 100 m.

## 2.4 Operating Instructions

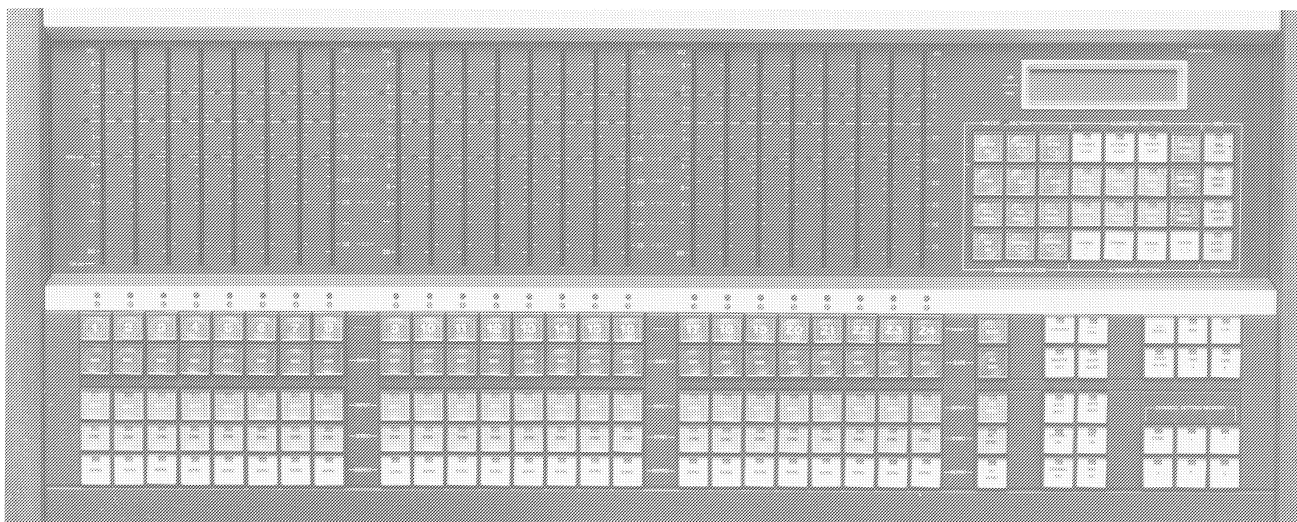

Fig. 2.4-1 Panel

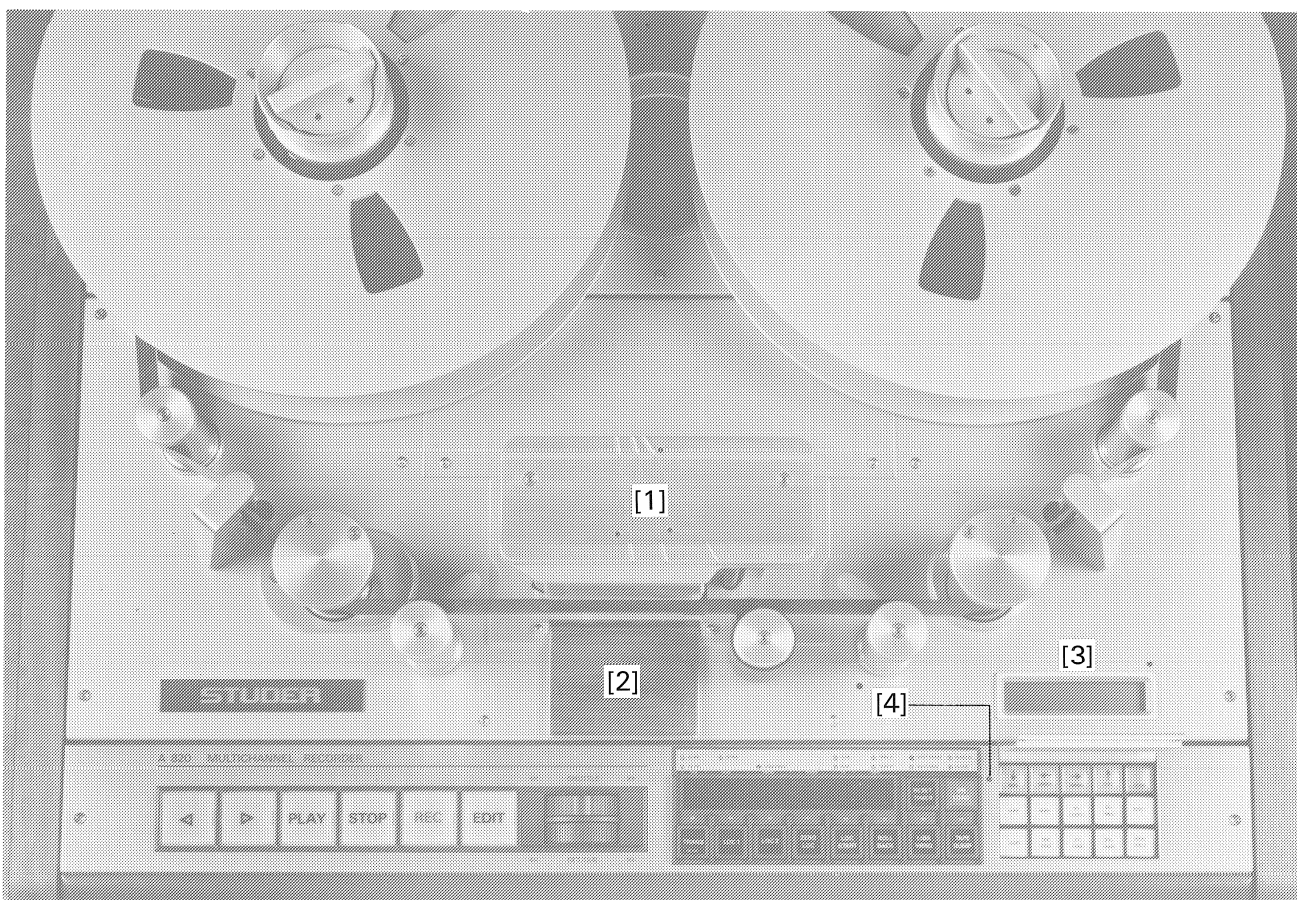

Fig. 2.4-2 Tape Deck

- [1] Splicing block
- [2] Head shield, can be closed or opened manually.
- [3] Service LC display; alphanumeric display for indicating the software status, speed deviation in varispeed mode, error messages, programming of tape deck parameters, etc.  
service display
- [4] Switch for enabling the MENU-Entry (must be unlocked with an Allen key size 2.5 as a protection against inadvertent modification of functions and parameters).  
Screw unlocked: Programming enabled.  
Screw locked: programming generally disabled (programming disable A).  
Programming disabled except:  
SET LIBRARY WIND SPEED  
SET MAX. WIND SPEED  
SET ROLLBACK TIME  
SET MAX. REEL  
(PROGRAM DISABLE B).  
Acknowledgment of error messages (with STORE key) is also permitted.

### 2.4.1 Power Switch

- Caution!** Before you switch on the recorder for the first time, check that the setting of the line voltage selector on the bottom right of the machine front matches the local line voltage.  
The power switch is located on the bottom right of the machine front.

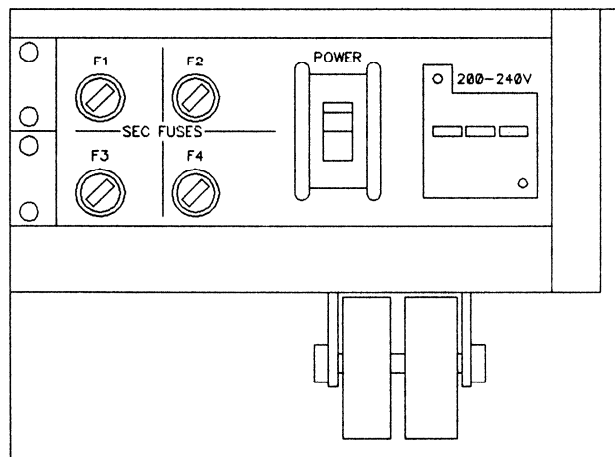

Fig. 2.4.1

- The last operating state is automatically reestablished and indicated after the power is switched on.
- Exceptions:** the recorder is always switched to STOP mode (the STOP key flashes if no tape is mounted or if the tape is mounted loosely). When the recorder is switched on, the microprocessor automatically tests the main functions; any error is indicated on the service display (see Section 2.6).

2.4.2 Control Keys

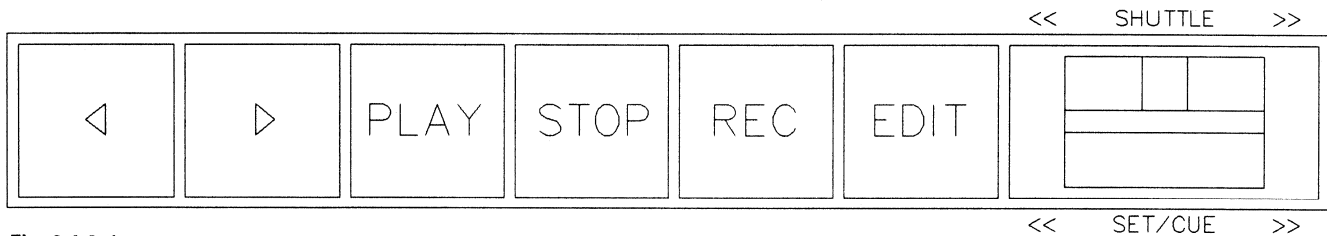

Fig. 2.4.2-1

- ◀ : fast rewind
- ▶ : fast forward
- PLAY:** reproduce mode
- STOP:** has priority over all tape deck keys or cancels a synchronizer LOOP. The stored locator addresses can be displayed by pressing STOP plus LOCSTART or LOC1...5.
- REC:** record key, only effective together with PLAY. (Prerequisite: the recording channel is switched to READY). In reproduce mode it is possible to switch directly to record by pressing REC (RECORD B), or PLAY + REC (RECORD A) depending on the programming.
- EDIT:** edit function, enables the SET/CUE wheel, and the position of the flutter roller is set in such a way that the tape can be easily gripped on the left-hand side of the headblock.
- SHUTTLE:** for positioning the tape with continuously variable spooling speed. Center position = STOP, counterclockwise limit position = maximum SHUTTLE rewind speed, clockwise limit position = maximum SHUTTLE forward speed.
- SHUTTLE BAR:** bar between SHUTTLE wheel and SET/CUE wheel. The spooling speed selected with the SHUTTLE wheel can be stored by pressing the SHUTTLE BAR.
- SET/CUE:** multifunction wheel:
  - In conjunction with the EDIT key: permits positioning of the tape; the tape moves in synchronism with the SET/CUE wheel.
  - In conjunction with the service display [3] and the cursor keys: either for "paging" through the menu or as a potentiometer knob for adjusting various tape deck parameters.
  - In conjunction with the VARISPEED function: knob for adjusting the desired tape speed.
  - In conjunction with the functions SET ADDRESS and SET TIMER: for entering the locator addresses and for setting the tape counter display.

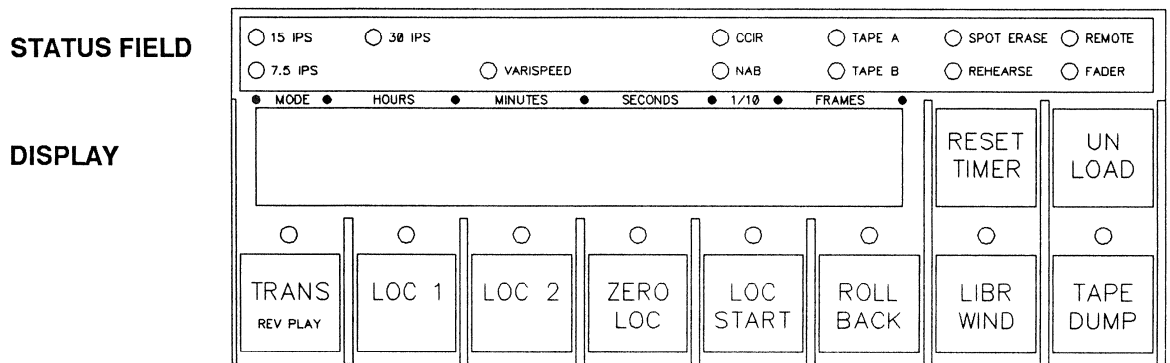

Fig. 2.4.2-2 (Standard Configuration)

- Display:** Tape timer LED display. Real-time indication at all tape speeds in hours, minutes, seconds, and tenths of seconds; switchable to indication of a second timer with user-selectable reference (LAP Counter).
- RESET TIMER:** reset button for the tape counter display.
- UNLOAD:** key for retracting pinch roller assembly
- TRANS:** preparation key for storing ("Transfer") a tape address in one of the (max.) five memory locations; storing the current address by pressing one of the keys LOC1...LOC5.  
If pressed simultaneously with PLAY: reverse play.
- LOC 1:** the address stored with [TRANS] is searched automatically. This LOCATE address is displayed for as long as this key is pressed. The internal memory relates to the actual tape address, i.e. when the tape counter is set to zero with RESET TIMER, the LOCATE address is automatically recomputed.
- LOC 2:** the address stored with [TRANS] is searched automatically. This LOCATE address is displayed for as long as this key is pressed. The internal memory relates to the actual tape address, i.e. when the tape counter is set to zero with RESET TIMER, the LOCATE address is automatically recomputed.
- LOC ZERO:** the tape address corresponding to the timer reading 0.00.00.0 is searched automatically. Relates to the actual zero position, both in normal mode as well as in LAP mode.
- LOC START:** automatically searches the tape address at which the last PLAY command (with tape stopped) was entered. Depending on the programming, the machine subsequently enters PLAY, STOP or RECORD mode (LOC START PLAY, LOC START STOP or LOC START REC function).
- ROLLBACK:** rewinds the tape by a programmable amount that can range from 1 to 99 seconds. Default value: 15 sec. Followed by three programmable possibilities: STOP (ROLLBACK-STOP), PLAY (ROLLBACK-PLAY) or RECORD (ROLLBACK-REC). Default: ROLLBACK-STOP.
- LIBR WIND:** library wind reduces the spooling speed for library pancakes. In conjunction with one of the spooling keys it initiates spooling at reduced speed. This preselection can be cancelled by pressing the LIBRARY WIND key a second time. Programmable for 0.1 to 15 m/s in steps of 0.1 m/s). Default value 5 m/s.

**TAPE DUMP:** Dump edit mode. Switches the right spooling motor off.  
 Four programmable possibilities:  
**TAPE DUMP-A:** Tape Counter active (supplied by the Capstan Motor Tacho).  
**TAPE DUMP-B:** Tape Counter off.  
**TAPE DUMP-C:** Tape dump edit mode is preselected, starts with PLAY. Tape Counter active (supplied by the Capstan Motor Tacho).  
**TAPE DUMP-D:** TAPE DUMP preselected, start with PLAY. Tape Counter off.

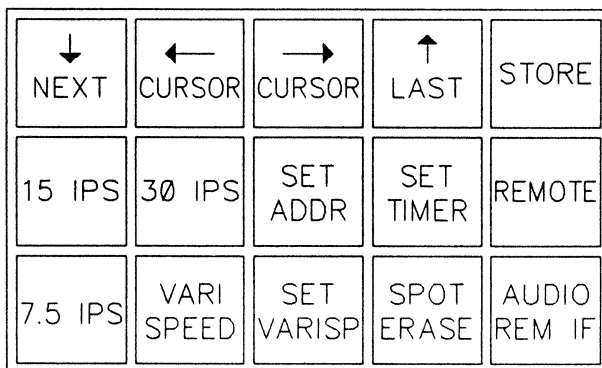
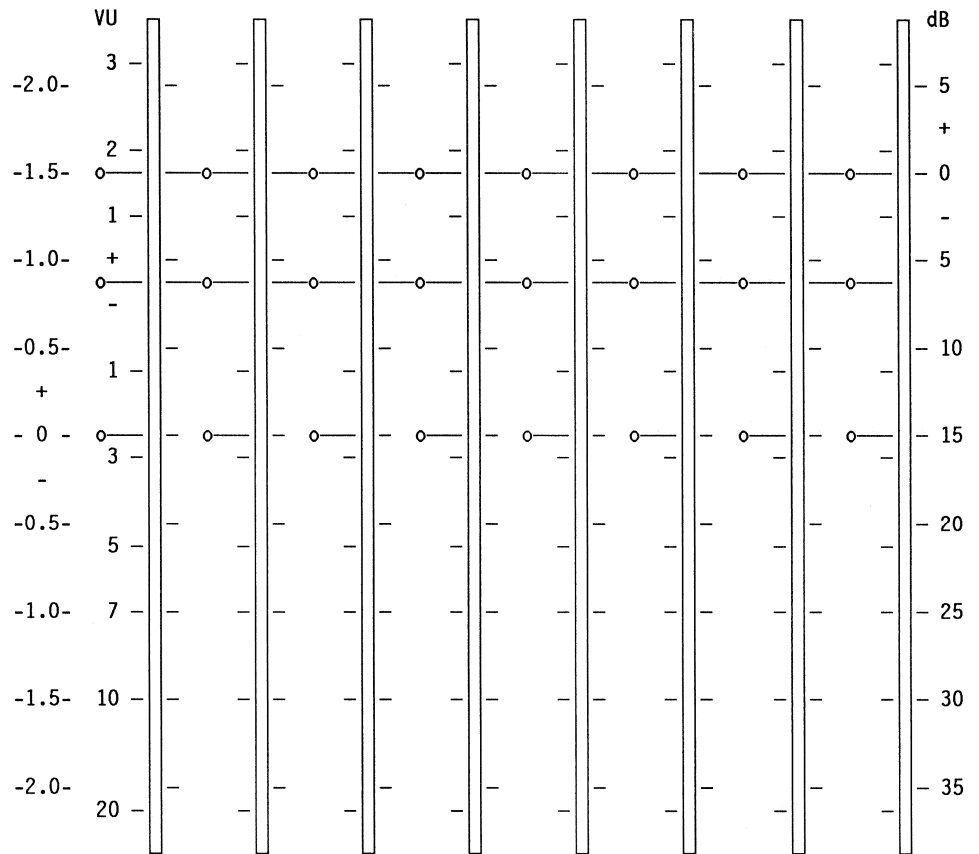

Fig. 2.4.2-3 (Standard Configuration)

- ↓/NEXT:
  - CURSOR/←:
  - CURSOR/→:
  - ↑/LAST:
  - STORE:
  - 15 IPS:
  - 30 IPS:
  - SET ADDR:
  - SET TIMER:
  - REMOTE:
  - 7.5 IPS:
  - VARI SPEED:
  - SET VARISP:
  - SPOT ERASE:
  - AUDIO REM IF:
- } keys for paging through the menu and for moving the cursor on the service display
- key for storing a changed tape deck parameter, for changing over a function that is not assigned to any key, for reprogramming a push button function (when pressed together with the corresponding key) or for acknowledging an error message.
- speed selection (38 cm/s).
- speed selection (76 cm/s)
- set address
- set timer
- activates the remote controls
- speed selection (19 cm/s)
- on/off switch for variable tape speed
- enables VARISPEED input with the aid of the SET/CUE wheel.
- spot erase
- activates the Parallel Channel Control Interface; the VU-meter Panel is disabled

### 2.4.3 VU-Meter Panel



- The level is indicated by a 50-segment bargraph display.
- The METER ON mode changes the resolution to 0.1 dB on a scale of = 2.5 dB.
- The characteristic of the meter (VU-mode or PPM-mode) is selectable in the menu with the function No. 053.
- Each meter-characteristic indicates the zero-point by its own LED-row.
  - Upper LED-row: zero reading in PPM-mode (yellow scale).
  - Medium LED-row: zero reading in VU-mode (white scale).
  - Lower LED-row: zero reading in METER ON-mode (blue scale).
  - Lower LED-row: zero reading in METER ON mode (blue scale) or flashes if the NR-System is on at the same time. Or it lits up when NR-System is on in another meter mode than METER ON (i.e. only in VU or PPM-mode).
- The LED at the bottom of each bargraph indicates the channel-on status.

### 2.4.4 Channel Selector Keys

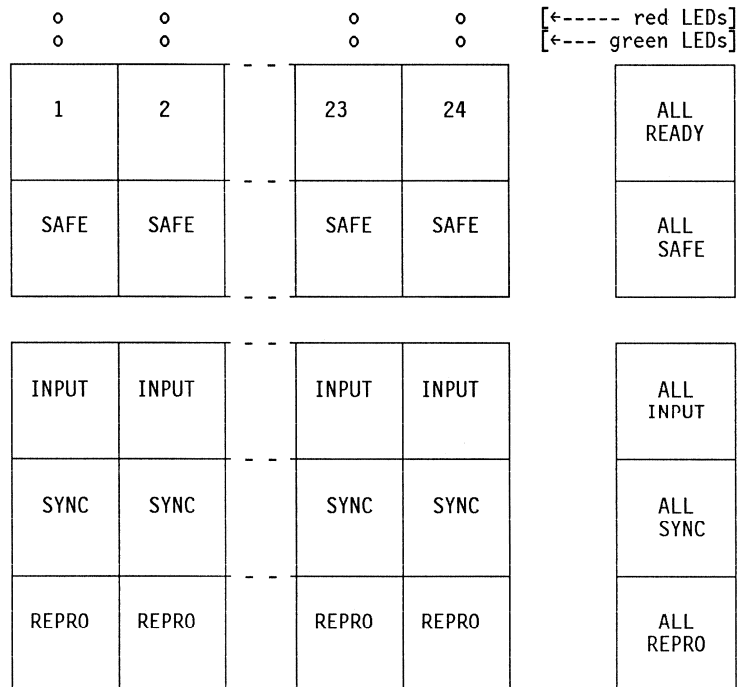

**Individual channel selection key:**

- Red LED: HF-Driver is active, i.e. RECORD is indicated as well as SPOT ERASE.
- Green LED: Flashes when the channel is switched to READY (enable) and is off as soon as the HF-Driver is on.
- SAFE: Channel inhibited for recording

**Individual output selector switches:**

- INPUT: Connects the input signal to the output and to the metering-panel.
- SYNC: Connects the SYNC reproduction signal (from the record head) to the output and the metering panel. This mode can be preselected for the RECORD function. As long as the corresponding channel operates in record mode, it is switched to INPUT because reproduction via record head is not possible during a recording. SYNC reproduction is automatically activated as soon as the channel is switched to READY or SAFE.
- REPRO: Connects the reproduce signal to the output and the metering panel.

Source/tape monitoring can be activated while a recording is in progress by pressing the INPUT and REPRO keys.  
 INPUT, SYNC, and REPRO are mutually self-cancelling.

**Master switch:**

- ALL READY, ALL SAFE, ALL INPUT, ALL SYNC, ALL REPRO: Same as above, but for all channels together.



## 2.4.5 Audio Mode Selectors

|             |               |  |                        |        |        |
|-------------|---------------|--|------------------------|--------|--------|
| REHEARSE    | NRS TONE      |  | SET ENABLE             | NAB    | CCIR   |
| MASTER SAFE | DELAY INHIBIT |  | DOLBY HX PRO           | TAPE A | TAPE B |
| AUTO INPUT  | AUTO MUTE     |  | CHANNEL SETTING MEMORY |        |        |
| CHANNEL ON  | NRS ON        |  | STORE                  | 1      | 2      |
| CHANNEL OFF | NRS OFF       |  | 3                      | 4      | 5      |

- REHEARSE:** Simulates the electronic editing. The PLAY and the REC keys flash in play mode. When REC + PLAY are selected, SYNC is switched to INPUT, however, RECORD is not activated. In order to switch back to SYNC, press the PLAY key. Precondition for REHEARSE: the corresponding channel must be switched to SYNC and READY, and DELAY INHIBIT must be OFF (i.e. the corresponding LED is dark). To cancel the REHEARSE function, press this key a second time.
- MASTER SAFE:** Record inhibition, switches all channels to SAFE. The READY function is disabled.
- NRS TONE:** Activates the tone/noise generator of the built-in noise reduction system.
- DELAY INHIBIT:** Time delay compensation. Delays the on/off switching (relative to the erase head) of the record head when the drop-in/drop-out is performed. When this key is pressed (i.e. the LED is lit), the time delay is switched off. Delay Inhibit = OFF is required for the REHEARSE function.
- AUTO INPUT:** All channels switched to SYNC (AUTO INPUT A) or SYNC and READY (AUTO INPUT B) are switched to INPUT in the operating modes STOP, REWIND, FORWARD, LOC, AND ROLLBACK. Normal setting: AUTO INPUT B. Activation of AUTO INPUT A OR B: see programmable function No. 052 AUTO INPUT A/B.
- AUTO MUTE:** Automatic muting in spooling mode (exception: tape lifter for cueing engaged) and during the start phase (until the nominal tape speed is attained).
- CHANNEL ON:** Press the CHANNEL ON key and simultaneously the SAFE key of the channel to be activated (1-24). With CHANNEL ON + ALL SAFE, all channels can be switched on. --> CH on LED indicates the status on.

- CHANNEL OFF:** Switches an audio channel off. The channel can be reactivated with the CHANNEL ON function. To switch off a channel, press CHANNEL OFF and simultaneously the SAFE key (1...24) of the channel to be switched off. With CHANNEL OFF + ALL SAFE, all channels can be switched off.
- NRS ON:** Activates the internal noise reduction system. Press the NRS ON key and simultaneously the SAFE key of the desired channel (1...24). With NRS ON + ALL SAFE, the noise reduction systems of all channels are activated. The center LED of the VU-meter indicates the NRS status:  
LED ON: noise reduction system switched ON  
LED OFF: noise reduction system switched OFF
- NRS OFF:** Disables the internal noise reduction system. Press the NRS OFF key and simultaneously the SAFE key of the desired channel (1...24). With NRS OFF + ALL SAFE, the noise reduction systems of all channels are disabled. The center LED of the VU-meter indicates the NRS status:  
LED ON: noise reduction system switched ON  
LED OFF: noise reduction system switched OFF
- NAB:** Switches the equalization to NAB standard. While holding down the SET ENABLE key, also press NAB.
- CCIR:** Switches the equalization to CCIR standard. While holding down the SET ENABLE key, also press CCIR.
- DOLBY HX-PRO:** Activates all channels of the DOLBY HX-PROFESSIONAL headroom extension circuit (standard feature). While holding down the SET ENABLE key, also press DOLBY HX-PRO.
- TAPE A:** Selector switch for tape type A. While holding down the SET ENABLE key, also press TAPE A.
- TAPE B:** Selector switch for tape type B. While holding down the SET ENABLE key, also press TAPE B.
- CHANNEL SETTING MEMORY:** Five memory areas (1...5) are available for storing 5 different channel settings. The current channel setting can be transferred into a memory by holding down the STORE key and simultaneously pressing the desired memory key (1...5). The stored channel settings can be recalled by pressing the corresponding memory key (1...5).

2.4.6 Metering and Audio Generator

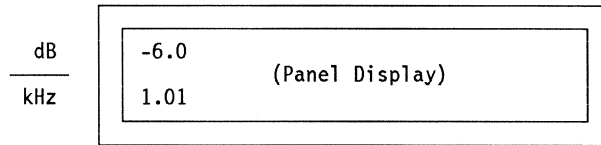

| METER SECTION     |               |                | ALIGNMENT SECTION |               |              |                 | NRS          |
|-------------------|---------------|----------------|-------------------|---------------|--------------|-----------------|--------------|
| METER ON          | M REF ↓       | M REF ↑        | AUTOREC ALIGN     | AUTOPAR ALIGN | MANUAL ALIGN | STORE START     | NRS ALIGN    |
| 0 dB              | -10 dB        | -20 dB         | REPRO LEVEL       | REPRO TREBLE  | REPRO BASS   | REF TAPE PRESET | UNCAL MODE   |
| 30 Hz SWEEP →     | 1 kHz SWEEP → | 10 kHz SWEEP → | RECORD LEVEL      | RECORD TREBLE | RECORD BIAS  | BIAS PRESET     | MANUAL ALIGN |
| GEN ON            | GENFREQ ↓     | GENFREQ ↑      | CHANNEL ←         | CHANNEL →     | PARAM ↓      | PARAM ↑         | AUTO ALIGN   |
| GENERATOR SECTION |               |                | ALIGNMENT SECTION |               |              |                 | NRS          |

Meter section

**METER ON:**

Switches all bar graph indicators to metering mode with an improved resolution of 0.1 dB per segment on a scale of ±2.5 dB.

**M REF ↓,  
M REF ↑:**

Sets the reference point for the high resolution metering. The current reference point on the dB scale is shown in the upper left corner of the LC display (e.g. -6.0). The measuring range is -30...+6 dB for PPM characteristic, and -24...+12 dB for VU characteristic.

## Generator section

---

|  |   |
|--|---|
| <b>GEN ON:</b>   | Activates the internal frequency generator. The current frequency is shown in the lower left corner of the LC display (e.g. 1.01 kHz). The generator range is 30 Hz...25.01 kHz.  |
| <b>GEN FREQ ↓,<br/>GEN FREQ ↑:<br/>30 Hz SWEEP,<br/>1 kHz SWEEP,<br/>10 kHz SWEEP:</b> | Permits manual setting of the generator frequency in steps of 10 Hz.<br>Pressed once: the generator frequency is set to the corresponding frequency (30 Hz, 1.01 kHz, 10.01 kHz).<br>Pressed twice: the generator SWEEPs the range starting at the corresponding frequency (30 Hz, 1.01 kHz, 10.01 kHz) up to 25.01 kHz.  |
| <b>0 dB,<br/>-10 dB,<br/>-20 dB:</b>   | Selects the attenuation of the internal generator with reference to the measurement scale for VU or PPM characteristic (e.g. 0 dB on the generator = 0 VU on the VU-meter or 0 dB on the PPM output meter).<br>The attenuation keys set the reference point of the high resolution meter to the corresponding level when the generator and the meter (METER ON) are simultaneously activated (i.e. when the generator is set to -10 dB, the reference point of the meter is automatically set to -10 dB). |

## 2.5 Operation

---

### 2.5.1 Pilot Lamps

---

During the power-on sequence, i.e. while the processor is being initialized, certain keys and indicator lamps may turn on, i.e. also READY and REC. However, the record function is electronically disabled during this time. After powering-up, the following keys or pilot lamps (LEDs) turn on and indicate the current operating state of the recorder:

- The STOP function is active. If this key flashes this means that both tape tension sensors are in their limit positions (no tape or tape mounted loosely).
- Tape speed: e.g. 15 ips.
- CCIR or NAB: indication of the selected equalization.
- TAPE A or TAPE B: tape type selection.
- VU-meters
- Channel selector set to: SAFE
- Channel selector set either to (INP, SYNC or REP).

For a few seconds, the service display (LCD) indicates the software version of the tape recorder (creation date of the master software, calendar week / year), followed by the possible option SMPTE/EBU interface options with which the recorder can be equipped plus possible error messages in plain text, or the message "no errors detected" and subsequently the current machine status (line level, as well as the type of noise reduction system that is connected and which channel, if any, has been assigned to the time code).

On the right-hand side of the electronics rack, six green LEDs indicate that the supply voltages are available: (+5.6 V, +24 V, +15 V, -15 V, +26 V, -26 V). Three of four fuses are also checked (see Fig. 2.4.1). If they are allright, one LED each (F1, F2, F3) is lit.

## 2.5.2 Threading the Tape

---

Thread the tape as illustrated in Fig. 2.4–2. The start of the tape is wound on the empty reel and secured by giving the reel a few turns. As soon as the tape is tensioned, the tape transport mechanism engages. The STOP key is off. The tape tension control circuit is activated as soon as one of the tape transport keys is pressed; the A820 MCH is now ready for operation. The STOP key is on now. Reset the tape timer to zero by pressing the RESET TIMER key. Close the head shield in front of the heads, if necessary.

**Important:** The head shield in front of the heads must be tilted downward to thread the tape.

## 2.5.3 Tape Speeds

---

Up to three tape speeds are available 7.5 ips / 15 ips / 30 ips (see menu: function 212–219). The speed can be selected by pressing the corresponding speed selector key below the flap cover; the corresponding pilot lamp lights up.

## 2.5.4 Play Mode

---

The built-in PLAY key, a remote control key, or a fader start device starts the tape recorder in PLAY mode. The PLAY pilot lamp lights up.

The PLAY function can be cancelled by pressing the STOP key or any other transport key.

If the PLAY key is pressed while a recording is in progress, the tape recorder switches to PLAY mode without interruption. If the PLAY key is pressed in winding, the tape decelerates and the preselected PLAY key flashes until the right speed is achieved.

## 2.5.5 Reverse Play Mode

---

By simultaneously pressing the TRANS and PLAY keys, the tape recorder can be switched to REVERSE PLAY mode. It is also possible to use a key with the programmed function REVERSE PLAY.

## 2.5.6 Varispeed Control

---

With the built-in varispeed control it is possible to deviate up to  $\pm 7.5$  semitones from the nominal tape speed.

The speed change can be preselected with the SET VARISP key and the SET/CUE wheel which in this case acts as a "potentiometer". This has no influence on the current nominal speed. The deviation is indicated on the service display either in semitones, percent of the nominal speed, or as the actual tape speed in inches per second (ips), depending on the programming.

The changeover from nominal speed to varispeed is performed with the VARISPEED key; the VARISPEED pilot lamp in the STATUS FIELD flashes.

When the SET VARISP and the VARISPEED functions are activated at the same time, the speed can be changed directly (with the SET/CUE wheel). The result is immediately audible during playback.

The timing correction for the drop-in and drop-out (see 2.5.7) is set for the nominal speed; a corresponding offset results when recordings are made in varispeed mode.

## 2.5.7 Record Mode

---

When the REC and the PLAY keys are pressed simultaneously, the tape recorder switches to record mode and the PLAY and REC keys lit up.

If PLAY and REC are pressed in spooling mode, the tape is decelerated. The record function is preselected, the REC and PLAY keys flash. As soon as the tape has reached the nominal speed, the recording mode is initiated and the two keys are continuously light.

From record mode it is possible to switch directly to fast wind, play or a locator function.

### SAFE/READY keys:

With the SAFE key the corresponding channel can be disabled for recording. The yellow SAFE pilot lamp lights up; if PLAY and REC are pressed together, the tape deck starts; recordings already existing on the audio track protected with the SAFE key are retained and can be monitored (REP or SYNC).

In order to prepare a channel for recording, the corresponding READY key must be pressed. The green READY pilot lamp lights up. When the recording is started with PLAY and REC, the red REC pilot lamp lights up to signal that the recording mode is active.

While a recording is in progress, recording on the channels can be inhibited directly with SAFE. In order to renable them for recording again, it is necessary to first press the READY key; when the READY pilot lamp lights up, either the PLAY and the REC key or only the REC key must be pressed, depending on the programming.

### MASTER SAFE key:

The MASTER SAFE function is a higher ranking record inhibition. As long as MASTER SAFE is active, the tape recorder can not be prepared for recording with the READY key.

**Drop in:** Click-free changeover from reproduction or sync reproduction to record is possible. Two modes can be programmed: in play mode, PLAY and REC must be pressed together (RECORD A), or the recording function is activated by pressing only the REC key (RECORD B). Depending on the settings, the erase and record heads are switched on simultaneously (DELAY INHIBIT active) or the record head switches on with a speed dependent delay in such a way, that there is no gap between the erased- and the nearly recorded part on tape (gapless recording with DELAY INHIBIT off).

**Drop out:** Click-free changeover from RECORD mode to PLAY or SYNC mode is possible. Depending on the settings, the erase and record heads are switched off simultaneously (DELAY INHIBIT active) or the record head switches off with a speed dependent delay in such a way, that there is no gap between the erased- and the previously recorded-part on tape (DELAY INHIBIT off). Dropping out by pressing SAFE always switches both heads off simultaneously. Dropping out by pressing STOP completes the drop-out process before the tape is subsequently stopped.

### 2.5.8 Sync Reproduction

---

The SYNC key switches the machine to sync reproduction. This means that the audio signals are not supplied by the reproduce head but by the record head via the reproduce amplifier. Since there is no time offset between the record head and the reproduce head in this mode, accurate drop-in is possible. For technical reasons, the reproduce frequency response in sync mode is limited to approx. 12 kHz. For special mixdowns, the bandwidth can be increased to 20 kHz by means of a jumper on the REPRODUCE AMPLIFIER (see Section 4.8.2). However, strong crosstalk from the record channel to the sync reproduce channel must be expected at frequencies above 12 kHz.

**SYNC preselection:** SYNC reproduction can be preselected for a channel that has been enabled for recording mode. When the SYNC key is pressed while a recording is in progress, the output of the corresponding channel is connected to the input (INP). This channel is automatically switched to SYNC reproduction when the drop-out occurs (PLAY, SAFE, STOP).

### 2.5.9 Wind Mode

---

The ► key activates the fast wind in the forward direction, the ◀ key in the rewind direction. The tape will be wound at the programmed spooling speed. The corresponding pilot lamp lights up.

The wind functions are cancelled by STOP, PLAY, REC+PLAY, SHUTTLE, LOC functions, and by winding in the opposite direction.

It is admissible to switch from rewind directly to fast forward and vice versa, or from play or record to wind.

From wind mode it is admissible to switch directly to play or record mode. In this case the keys of the preselected function flash; the tape is decelerated, and the preselected function is activated as soon as the tape has reached the nominal speed.

**Tape lifting** In spooling mode the tape is automatically lifted off the heads in order to minimize the wear of the tape and the heads. By activating the LIFTER function (see section 2.5.2), the lifter pin is retracted and the pinch roller assembly engages so that the tape contacts the head and the modulation becomes audible.

## 2.5.10 Producing Pancakes at Reduced Spooling Speeds, Library Wind

---

The reduced spooling speed (LIBRARY WIND) is intended for pancakes that are to be stored in a library, the speed can be adjusted in steps of 0.1 m/s between 0.1 m and 15 m/s (default 5 m/s). This function is activated by pressing the LIBRARY WIND key, followed by one of the wind keys ◀ or ▶. Also the locator functions will be performed at the reduced spooling speed as long as LIBRARY WIND is active.

This function can be cancelled by pressing LIBRARY WIND a second time or by switching the tape recorder off and on.

## 2.5.11 Stop Mode

---

The STOP key has the highest priority and cancels all operating states such as play, record, spooling, and autolocator. The tape is immediately decelerated after this function has been selected. The STOP key flashes until the tape has come to a stop after which this pilot lamp changes to steady light.

The tape tension control loop is always active (exception: tape unthreaded), and this is essential for manual editing.

- When STOP is held down while one of the keys LOC1...LOC5 is also pressed, the corresponding locator address is shown on the display.

## 2.5.12 Editing, Cutting the Tape

---

### Searching a tape address in fast wind

When the desired tape address is approximately known (e.g. start or end of a selection) it can be searched by means of the fast forward or rewind key. Actuate the programmable LIFTER key so that the tape lifter is retracted and the modulation becomes audible. As soon as the desired location is found, the tape can be accurately positioned by repetitively pressing ◀ or ▶, by actuating the SHUTTLE wheel, or by pressing EDIT and turning the SET/CUE wheel. Press the STOP key and move the tape to the exact edit position by carefully turning one of the two reel flanges (manual editing).

### Searching a tape address in PLAY:

If certain segments with unknown addresses are to be eliminated from a production, they can be searched in normal PLAY mode. When an edit point is found, press the STOP key and position the tape accurately by carefully turning one of the two reel flanges (manual editing).



**Searching a tape address with the Autolocator:**

With the ZERO-LOC key it is possible to search the tape address 0.00.00.0 automatically in spooling mode. The start of a production is automatically stored and if the recording has not been interrupted, it can be automatically searched with the LOC START key.

Up to 5 addresses (depend on the programming of the keys) can be stored directly by pressing TRANS and LOC1...5 at the desired address. When the corresponding LOC key is pressed, the stored address is automatically searched and the exact edit point can be manually adjusted.

**Marking the tape, cutting in the splicing block**

Mark the tape, as it is located in front of the reproduce head, on the reverse side of the tape, by using a grease pen or a soft pencil. Place the marked tape in the splicing block so that you can cut the tape on the given slit with a razor blade.

**Splicing the tape**

The two tape sections to be joined are inserted with the reverse (marked) side facing up into the splicing block. The ends are butted together (without overlap!) and spliced with an adhesive tab that is approx. 20 mm long and 1" or 2" wide.

**2.5.13 Tape Dump Mode**

In TAPE-DUMP mode the right-hand spooling motor is disabled. Unwanted tape segments can thus be played into the waste basket.

When the TAPE-DUMP key is pressed, the machine switches either to play or preselects the "TAPE DUMP mode", see below. The right-hand spooling motor is switched off. Four versions are available:

- TAPE DUMP A (default programming): Tape timer active, function can be cancelled with STOP or by pressing TAPE-DUMP again.
- TAPE DUMP B: Same as tape dump A but the tape timer is switched off.
- TAPE DUMP C: The TAPE DUMP key preselects the TAPE DUMP mode which is activated by pressing PLAY and cancelled with STOP. Tape timer is active. Can be cancelled only in STOP mode by pressing TAPE DUMP a second time.
- TAPE DUMP D: Same as TAPE DUMP C but the tape timer is switched off.

**Retracting a loose tape segment**

If too much tape has been inadvertently unwound, it is not necessary to rewind it manually. Thread or leave the tape threaded as shown in Fig. 2.5.13-1 Tension the tape with two fingers of your right hand (preferably gloved) and continually hold down the REWIND key. The left-hand spooling motor rotates and slowly takes up the loose tape. This process can be stopped by releasing the REWIND key.

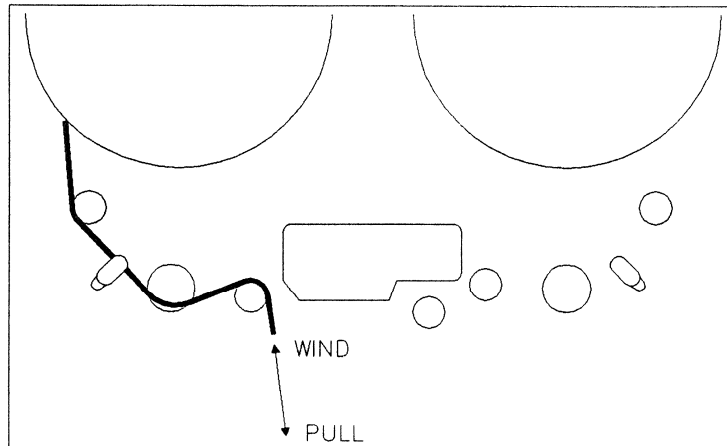

Fig. 2.5.13-1

The torque of the motor is limited and controlled in such a way that the tape can be easily stopped by hand. If you let loose of the tape, the motor turns very slowly; its speed increases as soon as some tension is applied to the tape. The same applies also to the rewinding of a tape segment with the right-hand spooling motor. It is important, however, that the tape segment to be wound is threaded across the tape tension sensor and the adjacent guide roller so that the tape tension control circuit can function correctly.

**Playing a discarded tape segment**

**Procedure:**

After a long editing session it may happen that many tape sections have been cut and that you are not certain whether or not they contain some usable material. With the A820 MCH tape recorder you can play cut segments without first splicing them and winding them on a reel. Press the EDIT key, the tape lifter and the pinch roller engage. The EDIT pilot lamp is active, STOP flashes. Insert a tape segments as illustrated in Fig. 2.5.13-2.

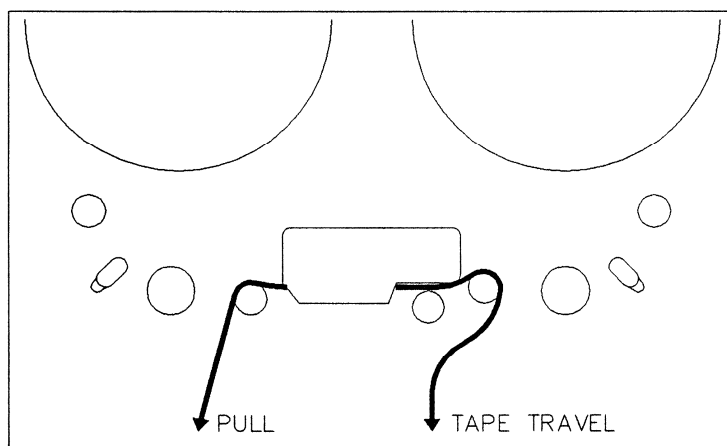

Fig. 2.5.13-2

With your left hand, slightly tension the tape on the left-hand side of the head-block and press PLAY with your right hand. The tape segment is drawn over the reproduce head and can be monitored. If slight backtension is created with your left hand, the contact of the tape with the head is improved (better reproduction), and any dust particles that the tape may have picked up in the waste basket are removed.

The PLAY function can be interrupted by pressing the EDIT key. If the STOP key is pressed the tape lifter disengages.

## 2.5.14 Locator

---

The locator supports the following modes:

- ZERO LOC: Zero locator. This key initiates a rewind (or fast forward) to the tape address that corresponds to the tape timer reading 0.00.00.0, regardless of whether the zero position of the main timer or the second timer is to be searched.
- LOC START (programmable): This key initiates a rewind (or fast forward) to the address at which PLAY was last activated (prerequisite: the tape must have been at standstill). Depending on the programming, either STOP (LOC START STOP function), play (LOC START PLAY function) or record (LOC START REC) is subsequently activated.
- LOC1...LOC5 (programmable): Transfer locator. Up to five tape addresses can be stored and automatically searched in spooling mode by pressing the corresponding key.

The locator function is cancelled by pressing: ◀, ▶, STOP, or EDIT.

### Programming:

Search the desired tape address. When it has been approximately reached, press the TRANS key. The address can be stored while the TRANS pilot lamp is active. When the exact position has been reached, press the corresponding LOC key. The TRANS lamp switches off to acknowledge that the address has been stored. The TRANS key must be pressed again if a new address is to be stored.

### Reading out an address:

During a LOC operation: by pressing the corresponding LOC key a second time, or in STOP mode by pressing the STOP key together with the corresponding LOC key.

### PLAY or REC preselection:

If the PLAY key is pressed once during a locate function (ZERO LOC, LOC START, LOC1...5) or if PLAY is pressed together with REC, the tape recorder switches automatically to play or record when the corresponding tape address is reached.

### Important:

All locate addresses remain stored even when the tape recorder is switched off. The locator addresses are not recomputed when the timer display is reset to zero or changed with the SET TIMER function.

## 2.5.15 Tape Timer

---

The electronic tape timer always displays the real tape time in hours, minutes, seconds, and tenths of seconds relative to the selected nominal tape speed.

The timer has a display range of -9 h 59 min 59.9 s to 23 h 59 min 59.9 s. Figures that are outside this range are indicated by a "u" (underflow, negative value too small) or a "o" (overflow, positive value too large) in the tens of hours position e.g. u4.00.00.0 or o3.03.35.7.

Fractional tenths of a second are rounded. The timer is set to 0.00.00.0 when the RESET TIMER key is pressed.

At the end of the tape or if the tape is torn the timer stops automatically. In TAPE DUMP mode the timer continues to run or stops, depending on which of the four TAPE DUMP modes has been programmed. (Standard programming: TAPE DUMP A, timer continues to count with the tacho information supplied by the capstan motor).

### 2.5.16 Auxiliary Tape Timer

---

With the LAP key (function No. 334) the tape counter display can be switched to a second (auxiliary) tape timer with a user-selectable reference. The auxiliary timer mode is signalled by an "L" in the first position of the display.

The auxiliary timer can be set to zero (RESET TIMER key) at any tape address and can thus be used for determining the exact playing time of a selection without having to compute the difference between the start and the end time. When the LAP key is pressed a second time, the display switches back to the main timer, the "L" in the first position disappears.

Locator addresses will remain unchanged when switching between times.

### 2.5.17 Remote Control

---

The following functions can be remote controlled by means of the **parallel remote control** unit: play, record, winding, stop, RESET TIMER, ZERO LOC, LOC START, BACKSPACE (rewinding for as long as the key is pressed, followed by PLAY) or LIFTER (defeating the tape lift during winding), and FADER (FADER START ready).

The keys of the **serial remote control** can be assigned to any function that could be programmed on the local keypad, regardless of the programming of the local keypad; i.e. it is not necessary to program the same functions on the serial remote control as on the keypad of the tape recorder. In addition, the serial remote control features a tape timer and a SHUTTLE wheel. The functions of the remote control keys are programmed in the same way as the keys on the local keypad.

- Operation with programmable function REMOTE A:  
When the REMOTE key is pressed, the corresponding pilot lamp lights up and the local keypad is disabled. When the REMOTE key is pressed again, the local keypad is reactivated and the pilot lamp switches off. The keys of the remote control are dead in this condition.
- Operation with the programmable function REMOTE B:  
When the REMOTE key is pressed, the corresponding pilot lamp lights up and the remote control keys and the local keys are equivalent. When the REMOTE key is pressed again, only the local keypad is active and the pilot lamp switches off.
- Operation without the REMOTE A or REMOTE B function:  
The REMOTE LED is continuously on, the keys of the local keypad and the remote control are equivalent.

## 2.5.18 Time Code Channel (Option)

---

- The channel equipped with the time code option is automatically indicated on the LC display of the tape deck.
- Any changes in the parameters of the time code channel (equipped with high-speed reader) have no influence on the audio data.
- Neither are the time code parameters influenced when the audio parameters of the same channel are changed.

- Time code recording:** While holding down SET ENABLE simultaneously press READY on the channel equipped with the time code electronics. The READY lamp lights up. The recording is started by pressing REC + PLAY.
- Time code reproduction:** Press REPRO or SYNC on the channel equipped with the time code electronics and start the tape recorder in play mode. For reading the time code at high speed or in wind mode, SYNC should preferably be used.
- Time code level indication:** INPUT mode: The bar graph indicates 0 VU  $\pm$ 1 segment (VU characteristic) or -6 dB  $\pm$ 1 segment (PPM characteristic) when the level of the time code signal is within 0.25Vpp ... 4Vpp (nom. 2Vpp) on the time code input.  
SYNC mode: The bar graph indicates the current time code level from tape (record head).

## 2.6 Soft Keys, Status Tree Diagram for A820 MCH 1" and 2" Version

Each operating key of the A820 MCH tape recorder (except the four blue and red keys of the function and programming key pad below the hinged cover) can be assigned to any of the approx. 100 possible functions or operating modes. This applies to the functions identified as "KEYS ONLY" as well as to those with the designation "KEYS/MODE".

KEYS ONLY: functions that can be operated only if they are assigned to a key.

KEYS/MODE: functions that can also be operated via the programming keypad, without the function being assigned to a key.

In order to simplify the function assignment, the service display (alphanumeric LC display on the right front of the tape deck) and the following downward branching status tree diagram is used.

This diagram consists of blocks and selections

For programming examples refer to Section 2.5.3

**Important:** Programming is only possible when the tape recorder is in STOP or TAPE OUT mode!

After the tape recorder has been powered on, the first four (possibly five) blocks appear consecutively on the display for several seconds:

```
A820M MULTI CH VERS:
MASTER: WW/YY
```

Creation date of the MASTER software, calendar week/year,

```
A820M OPTIONS
```

The SMPTE/EBU interface will be displayed if installed.

```
=====
DEFAULT AUDIO
PARAMETERS LOADED
=====
```

If this message appears, the default audio parameters have been loaded after a RAM error. These parameters can deviate somewhat from the machine-dependent parameters. The tape recorder can be operated, but deviations from the optimum calibration data are inevitable. If the machine-dependent parameters have been written down or saved on tape, they can be reentered or reloaded.

```
ERROR LIST
```

Plain-text error messages (if any) resulting from the automatic self-test, or the message "no errors detected", and

```
L RANGE 0/6 d1m
MRS: NONE TC: NONE
```

The first line specifies the line level at which the tape recorder operates. The second line specifies the type of internal noise reduction system that is installed (if any). If the time code option is installed, the corresponding channel number is displayed here.

The process stops here. The above four (or five) blocks can be recalled in normal operation by pressing the keys ↑LAST.

When the programming lock [..] is closed (Allen key size 2.5; clockwise limit position), the status tree cannot be accessed and the various parameters cannot be modified (F247 = program disable A). If function 247 is set to "program disable B", the tape deck parameters (reduced and maximum wind speed, ROLLBACK time, maximum reel diameter) can still be changed and stored. Error messages can be acknowledged with STORE when the programming lock is closed (except: serious problems).

It is not possible to reprogram any key functions when the lock is closed. Any attempt will be signalled on the service display with the message "program mode not enabled". To open the programming lock: give the screw 2-3 counter-clockwise turns.

The keys ↓NEXT, ←CURSOR, →CURSOR, and ↑LAST are used for navigating up and down within the tree diagram. In order to branch off, position the cursor below the desired menu.

Status Tree Diagram for SW 4/91

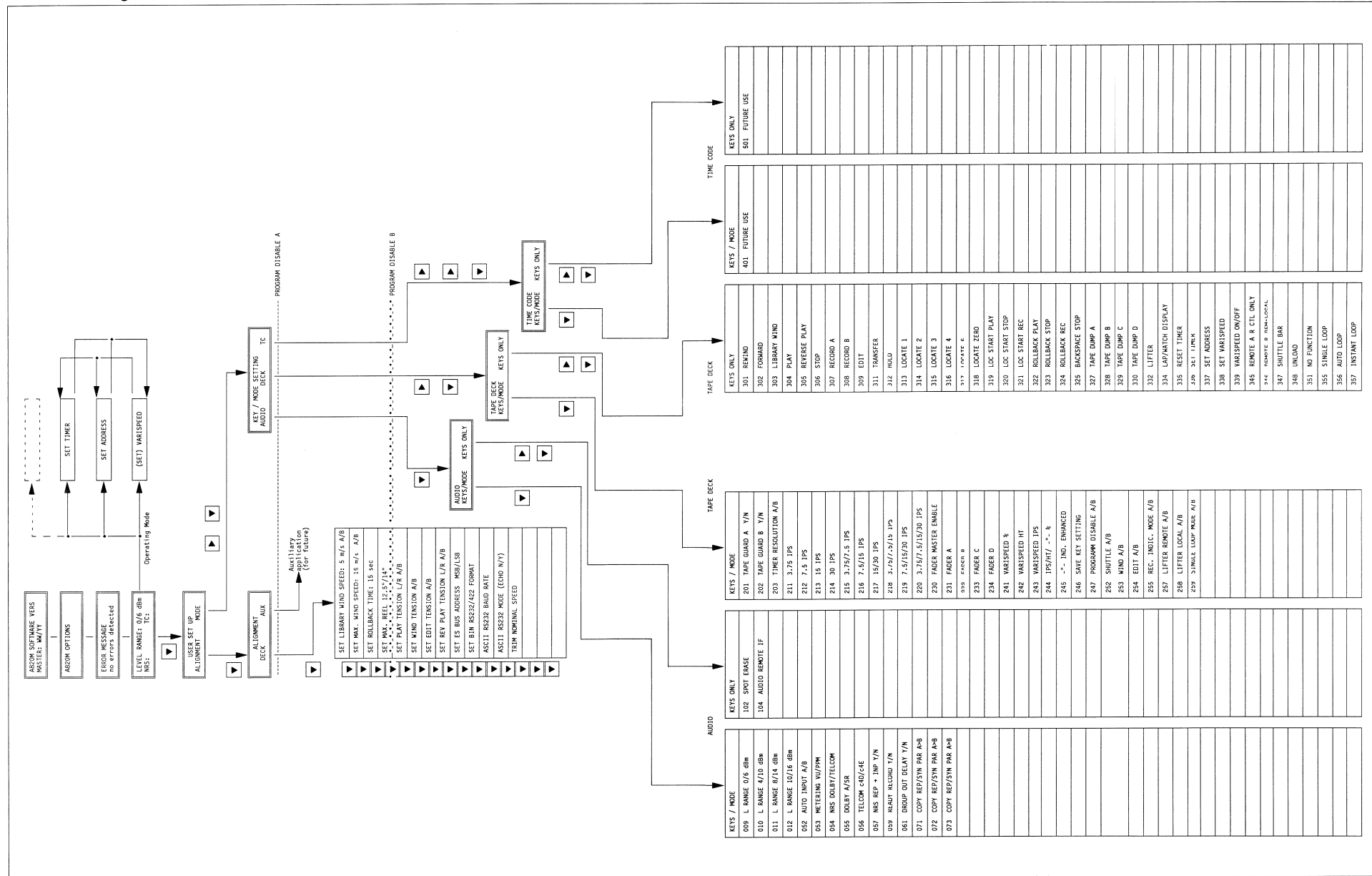

## 2.6.1 Key Numbering

The operator keypad is designed as a matrix comprising 5 rows with up to 10 keys each.

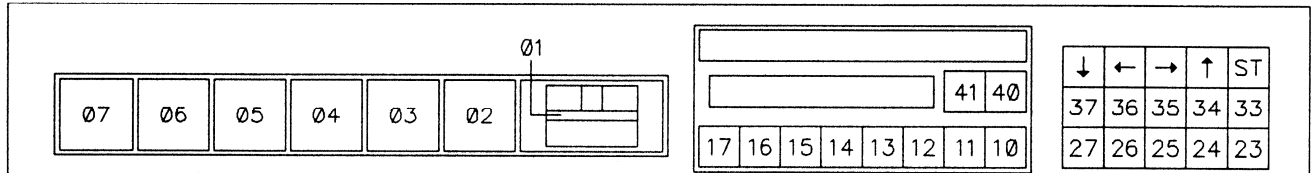

Fig. 2.6.1

## 2.6.2 Description of the Functions

|         |           |     |           |           |
|---------|-----------|-----|-----------|-----------|
| L RANGE | 0/ 6 dBm  | Y/N | (No. 009) | KEYS/MODE |
| L RANGE | 4/10 dBm  | Y/N | (No. 010) | KEYS/MODE |
| L RANGE | 8/14 dBm  | Y/N | (No. 011) | KEYS/MODE |
| L RANGE | 10/16 dBm | Y/N | (No. 012) | KEYS/MODE |

Definition of the line level at which the tape recorder works.

The first of the two level indications is valid if the meter are programmed for VU characteristic, the second is valid for PPM characteristic.

In case the line level in the studio deviates from the four available graduations, the closest value to the studio level should be selected and the internal record and reproduce levels should be adjusted in such a way that the tape recorder operates with the desired magnetic flux (for examples see 4.2.6).

|                |           |           |
|----------------|-----------|-----------|
| AUTO INPUT A/B | (No. 052) | KEYS/MODE |
|----------------|-----------|-----------|

Selection of the AUTO INPUT function. Switches all channels in SYNC (AUTO INPUT A), or only the channels in SYNC and READY (AUTO INPUT B), to INPUT in the operating modes STOP, REWIND, FORWARD, LOC AND ROLLBACK.  
Default: AUTO INPUT B.

|                 |           |           |
|-----------------|-----------|-----------|
| METERING VU/PPM | (No. 053) | KEYS/MODE |
|-----------------|-----------|-----------|

Selects VU or PPM characteristic for the meters.

|                  |           |           |
|------------------|-----------|-----------|
| NRS DOLBY/TELCOM | (No. 054) | KEYS/MODE |
|------------------|-----------|-----------|

Selects your preferably NR-system for internal or external use such as Dolby A, Dolby SR, Dolby A/SR or TELCOM C4D, C4E. It selects also the right logic level (HIGH/LOW) on the 15-pin D-Type connectors for the control of an external noise reduction system. Prerequisite: machine equipped with the option 20.820.385 (Ext. NRS-controller).

- In position DOLBY, the open collector output is active LOW.
- In position TELCOM, the open collector output is active HIGH.



NRS DOLBY A/SR (No. 055) KEYS/MODE

Selects the DOLBY noise reduction module: DOLBY A (Cat. 22/Cat. 450), DOLBY SR (Cat. 280/Cat. 350) or the combined one DOLBY A/SR (Cat. 300).

TELCOM c4D/c4E (No. 056) KEYS/MODE

Selects the TELCOM noise reduction system: either TELCOM c4D or c4E.

GROUP SELECT Y/N (No. 59) KEYS/MODE

Not functional yet.

DROUP OUT DELAY Y/N (No. 61) KEYS/MODE

Drop Out delay activated ("YES") or not activated ("NO") in DELAY INHIBIT mode.

SPOT ERASE (No. 102) KEYS ONLY

**Important:** SPOT ERASE can only be activated if the tape transport is in EDIT mode. After SPOT ERASE has been activated, the corresponding LED lights up for approx. 2–3 seconds. If the EDIT and REC keys are pressed simultaneously during this time, the manual erase function is activated, i.e. the erase head is active on all channels with preselected READY mode. The tracks can be erased manually by shuttling the tape in front of the heads. This method is suited for eliminating minor speech faults, switching clicks, etc. The SPOT ERASE function is indicated by the flashing SPOT ERASE LED and the flashing REC and EDIT keys. To cancel SPOT ERASE press the STOP key. "DON'T LEAVE THE HEAD ACTIVE FOR TO LONG (HEAT MAY DAMAGE THE HEAD)!"

AUDIO REM IF (No. 104) KEYS ONLY

Activates the parallel channel control interface 21.328.500.00; the local meter panel and the audio remote control are disabled. When this function is active, the message "AUDIO REMOTE IF ENABLED" is displayed on the LC display of the meter panel. Cancellation: press the key a second time.

TAPE GUARD A NO/RED (No. 201) KEYS/MODE

Reduction of the wind speed shortly before the tape unthreads. From the difference in the speed between the two spooling motors, the tape deck microprocessor knows that only little tape is left on the corresponding feed reel. The wind speed is reduced under the following conditions:

- The hub diameter is correctly defined in the ALIGNMENT DECK block (see 2.6.3, example 1)

- The TAPE GUARD A function is switched on.  
To suppress this function, hold down the fast forward or rewind key continuously.

|  |
|--|
| TAPE GUARD B NO/STOP (No. 202) KEYS/MODE |
|--|

Activate stop shortly before the tape unthreads.

From the difference in the speed between the two spooling motors, the tape deck microprocessor knows that only little tape is left on the corresponding feed reel. The stop is initiated under the following conditions:

- The hub diameter is correctly defined in the ALIGNMENT DECK block (see 2.6.3, example 1)
- The TAPE GUARD B function is switched on.

To suppress this function, hold down the fast forward or rewind key continuously.

|  |
|--|
| TIMER RESOLUTION A/B (No. 203) KEYS/MODE |
|--|

Tape counter indicates with a resolution of seconds ("B") or tenths of seconds ("A"). Works also with transport remote controls.

|               |                     |
|---------------|---------------------|
| 7.5 IPS       | (No. 212) KEYS/MODE |
| 15 IPS        | (No. 213) KEYS/MODE |
| 30 IPS        | (No. 214) KEYS/MODE |
| 7.5/15 IPS    | (No. 216) KEYS/MODE |
| 15/30 IPS     | (No. 217) KEYS/MODE |
| 7.5/15/30 IPS | (No. 219) KEYS/MODE |

Speed selection keys. It is possible to program either one key for each speed (functions 212...214), or combination keys (changeover with each key press, (functions 216...217) or a "wraparound key" (the next speed is selected whenever this key is pressed, function 219).

|   |
|---|
| FADER MASTER ENABLE (No. 230) KEYS/MODE |
|---|

When the FADER MASTER is disabled, the FADER START operation can not be activated. When the tape recorder is operated in conjunction with the TLS 4000 synchronizer, the FADER MASTER is disabled by the TLS4000 so that the synchronizer has control over the machine.

|         |                     |
|---------|---------------------|
| FADER A | (No. 231) KEYS/MODE |
| FADER B | (No. 232) KEYS/MODE |
| FADER C | (No. 233) KEYS/MODE |
| FADER D | (No. 234) KEYS/MODE |

With the FADER START circuit the tape recorder can be remotely switched to PLAY, e.g. with a fader of the mixing console.

Fader Start operation:

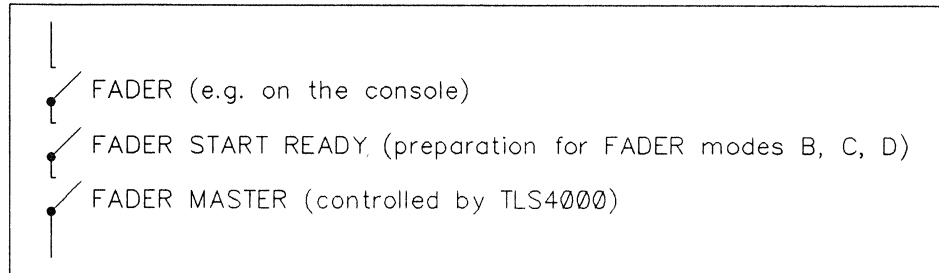

Fig. 2.6.2

In FADER modes B, C, D, the FADER START operation has to be prepared (FADER START READY) by a switch which interconnects pin 6 (SR-FADRY) with pin1 (Ground) of the PARALLEL REMOTE connector.

The FADER START is then initiated by applying 5 to 24V AC or DC between pins 11 and 12 (see section 2.3.3).

The same preparation can also be done with the programmable FADER key (functions No. 231, 232, 233, 234) on the local keypad or on the serial remote control, or with the FADER key on the parallel remote control.

The FADER mode (A, B, C or D) on the parallel remote control is always the same as the one selected on the machine itself, whereas the FADER mode on the serial remote control can be different from the one selected on the machine.

There are four different FADER START mode:

- FADER A:** FADER START without the preparation. The local keypad is disabled, except for the speed keys. The FADER switch must be reactuated after the tape has unthreaded.
- FADER B:** FADER START with preparation (FADER START READY), the local keypad remains active when preparation is on. The local keypad is disabled after the FADER START has been initiated; this is the default programming.
- FADER C:** Same as FADER B, except that the local keypad is disabled when the preparation is on.
- FADER D:** Same as FADER B, except that the local keypad remains active after the FADER START has been initiated.

While a recording is in progress, neither the FADER START switch nor the FADER switch influence the tape deck.

|                   |           |           |
|-------------------|-----------|-----------|
| VARISPEED %       | (No. 241) | KEYS/MODE |
| VARISPEED HT      | (No. 242) | KEYS/MODE |
| VARISPEED IPS     | (No. 243) | KEYS/MODE |
| VARISPEED IPS/HT% | (No. 244) | KEYS/MODE |

Defines the VARISPEED display format. The deviation from the nominal speed is indicated in percent, in semitones, or the actual speed in ips is displayed. For each format a separate key (functions 241...243) or a "wraparound key" (the next function is selected with each keystroke, function 244) can be programmed.

For setting or on/off-switching of the variable tape speed: see functions No. 338 and 339.

|                     |           |           |
|---------------------|-----------|-----------|
| VARISPEED IND. ENH. | (No. 245) | KEYS/MODE |
|---------------------|-----------|-----------|

If selected, this on/off function causes the fast forward and rewind keys to flash in VARISPEED mode in addition to the VARISPEED LED.

For setting or on/off-switching of the variable tape speed: see functions No. 338 and 339.

SAVE KEY SETTING Y/N (No. 246) KEYS/MODE

A change of the headblock (e.g. if converted from 2" to 1" format), the programming of the function keys is automatically set to the default setting when "NO" is selected. "YES" saves the programmed functions.

PROGRAM DISABLE A/B (No. 247) KEYS/MODE

- Program disable A: programming lock inhibits the entry to the menu.
- Program disable B: programming lock inhibits the entry to the menu except for: SET LIBRARY WIND SPEED, SET MAX. WIND SPEED, SET ROLLBACK TIME, SET MAX. REEL.

SHUTTLE A/B (No. 252) KEYS/MODE

**SHUTTLE A:** Tape contacts the heads in shuttle mode.  
**SHUTTLE B:** Tape is lifted off the heads in shuttle mode.

WIND A/B (No. 253) KEYS/MODE

**WIND A:** Tape contacts the lifter pin in spooling mode.  
**WIND B:** The tape is retracted from the lifter pin (all rollers are completely retracted).

EDIT A/B (No. 254) KEYS/MODE

**EDIT A:** Tape tension control is active in edit mode (one-hand cueing possible).  
**EDIT B:** No tape tension control in edit mode.

REC INDIC MODE A/B (No. 255) KEYS/MODE

- Rec Indic Mode A: record indication and record tally are only active if at least one channel is in record mode.
- Rec Indic Mode B: record indication and record tally are independent of the record status of the audio section.  
 Application: "Follow external record" with TLS 4000.

LIFTER REMOTE A/B (No. 257) KEYS/MODE

Also refer to function LIFTER No. 332 and function AUTOINPUT No. 052.  
**Remote:** Identifies the keypad of the parallel remote control.  
**Pos. A:** The status of the audio channels (INPUT, REPRO, SYNC) is not influenced when the LIFTER function is activated.  
 Application: reading the time code in wind mode.  
**Pos. B:** When AUTOINPUT is selected, the audio channels are switched from INPUT back to SYNC as soon as the LIFTER function is activated.  
 Application: monitoring the audio channels during wind.

LIFTER LOCAL A/B (No. 258) KEYS/MODE

See also functions LIFTER No. 332 and AUTOINPUT No. 052

- Local:** Identifies the local keypad and the serial remote control.
- Pos. A:** The status of the audio channel (INPUT, REPRO, SYNC) is not influenced when the LIFTER function is activated.  
Application: reading the time code in wind mode.
- Pos. B:** When AUTOINPUT is selected, the audio channels are switched from INPUT back to SYNC as soon as the LIFTER function is activated.  
Application: monitoring the audio channels during wind.

REWIND (◀) (No. 301) KEYS ONLY

Rewind with maximum (programmed) wind speed.  
This function can be selected from: FORWARD, STOP, PLAY/REC, SHUTTLE stored, any LOC function, CUE.  
Cancellation: press FORWARD, STOP, PLAY, SHUTTLE, SHUTTLE BAR, any LOC function; in synchronizer mode by pressing LOCK.  
Wind speed can be defined in the ALIGNMENT DECK block; default: 15 m/s.

FORWARD (▶) (No. 302) KEYS ONLY

Fast forward with maximum (programmed) wind speed. Activation/cancellation conditions: same as REWIND.

LIBRARY WIND (No. 303) KEYS ONLY

In conjunction with FORWARD or REWIND, preselection of this function causes the tape to be wound with defined, reduced speed (programmable from 0.1 to 15 m/s in increments of 0.1 m/s).  
Cancellation: press LIBRARY WIND key a second time.  
The reduced wind speed can be defined in the ALIGNMENT DECK block; default: 5m/s.

PLAY (No. 304) KEYS ONLY

Playback with the selected tape speed.  
Cancellation: press REC/PLAY, FORWARD, REWIND, STOP, EDIT, SHUTTLE, or any LOC function.

REVERSE PLAY (No. 305) KEYS ONLY

Playback in the reverse direction.  
This function is selected either with a correspondingly programmed function key or by simultaneously pressing TRANSFER and PLAY.  
Cancellation: see PLAY.

|      |                     |
|------|---------------------|
| STOP | (No. 306) KEYS ONLY |
|------|---------------------|

Has priority over all tape transport functions.

|          |                     |
|----------|---------------------|
| RECORD A | (No. 307) KEYS ONLY |
|----------|---------------------|

Record mode, only possible in conjunction with PLAY.

Activation: simultaneously press REC and PLAY.

Cancellation: see PLAY, drop-out is possible by pressing PLAY (the recorder switches to play mode without interruption).

This command is not accepted and not acknowledged by illuminating the key if:

- MASTER SAFE is switched on,
- No HF driver is installed,
- If none of the channels is switched to READY.

|          |                     |
|----------|---------------------|
| RECORD B | (No. 308) KEYS ONLY |
|----------|---------------------|

Record mode, only possible in conjunction with PLAY; analogous to RECORD A.

Difference: If the recorder already operates in play mode, REC can be activated by pressing only the REC key.

|      |                     |
|------|---------------------|
| EDIT | (No. 309) KEYS ONLY |
|------|---------------------|

EDIT changes the tape transport status to have TAPE/HEAD contact!

Depending now on the function No. 254 EDIT A/B:

- EDIT A: One-hand cueing tape tension controlled, SHUTTLE possible and SET/CUE.
- EDIT B: Cueing possible but no tape tension control.

This function is also used to playback cut tape segments.

|          |                     |
|----------|---------------------|
| TRANSFER | (No. 311) KEYS ONLY |
|----------|---------------------|

#### Multifunction key:

- Preparation for storing the current tape timer address in a locator memory. When one of the keys LOC1...LOC5 is pressed after the TRANSFER key, the momentary address is transferred into the corresponding LOC memory, regardless of whether the main timer or the auxiliary timer is active.  
Activation: this function can be selected at any time.  
Cancellation: by storing an address in a LOC memory or by pressing TRANSFER a second time.
- Pressed together with PLAY: playback in the reverse direction, see REVERSE PLAY.

|      |                     |
|------|---------------------|
| HOLD | (No. 312) KEYS ONLY |
|------|---------------------|

Key for "freezing" the momentary tape timer reading (also works with the auxiliary tape timer). The frozen timer reading can then be transferred into the LOC memory by pressing one of the keys LOC1...5. The tape timer continues to count. When the same LOC key is pressed a second time, the tape is positioned at the stored address.

If the TRANSFER key is pressed after the HOLD key, followed by one of the keys LOC1...5, the tape timer reading remains frozen.

Cancellation: By pressing the HOLD key a second time or by storing in LOC1...5.

|      |                     |
|------|---------------------|
| LOC1 | (No. 313) KEYS ONLY |
| LOC2 | (No. 314) KEYS ONLY |
| LOC3 | (No. 315) KEYS ONLY |
| LOC4 | (No. 316) KEYS ONLY |
| LOC5 | (No. 317) KEYS ONLY |

**Locator Memories:**

Automatic locating to the stored address; preselection of PLAY or PLAY + REC is possible (the keys of the preselected function flash while the LOC process is still in operation).

Indication of the target address: in STOP mode by simultaneously pressing STOP and the corresponding LOC key; while the LOC process is running: by continuously holding down the corresponding LOC key.

All LOC addresses remain stored when the tape recorder is switched off!

Activation: from PLAY/REC, REWIND, FORWARD, LOC, SHUTTLE, EDIT.

Cancellation: by pressing STOP, LOC, REWIND, FORWARD, SHUTTLE, SHUTTLE BAR,

|          |                     |
|----------|---------------------|
| LOC ZERO | (No. 318) KEYS ONLY |
|----------|---------------------|

Automatic locating to the address 0.00.00.0; preselection of PLAY + REC possible.

Activation/cancellation: see LOC1...LOC5.

|                |                     |
|----------------|---------------------|
| LOC START-PLAY | (No. 319) KEYS ONLY |
| LOC START-STOP | (No. 320) KEYS ONLY |
| LOC START-REC  | (No. 321) KEYS ONLY |

Automatic locating to the address at which the last STOP to PLAY transition was entered, (i.e. Tape in STOP-mode and then command PLAY).

When the target address is reached, the PLAY or STOP or RECORD command is automatically initiated.

Activation/cancellation: see LOC1...LOC5.

|               |                     |
|---------------|---------------------|
| ROLLBACK-PLAY | (No. 322) KEYS ONLY |
| ROLLBACK-STOP | (No. 323) KEYS ONLY |
| ROLLBACK-REC  | (No. 324) KEYS ONLY |

The tape recorder winds automatically backward by a preselectable time (01..99) ROLLBACK always relates to the current tape timer content (even if other display modes are selected).

When the target address is reached, the PLAY or STOP or RECORD command is automatically initiated.

Activation: from STOP, PLAY, RECORD, EDIT mode.

Cancellation: by pressing STOP, REWIND, FORWARD, PLAY, PLAY + REC, SHUTTLE, SHUTTLE BAR, any LOC function.

The ROLLBACK TIME can be defined in the ALIGNMENT DECK block.

|                |                     |
|----------------|---------------------|
| BACKSPACE STOP | (No. 325) KEYS ONLY |
|----------------|---------------------|

This function permits rewinding with tape/head contact at four times the play speed.

|             |                     |
|-------------|---------------------|
| TAPE DUMP A | (No. 327) KEYS ONLY |
| TAPE DUMP B | (No. 328) KEYS ONLY |

- TAPE DUMP A:** TAPE DUMP-mode switches the right spooling motor off. The tape timer is active and the required information is supplied by the capstan motor tacho
- TAPE DUMP B:** The tape timer is disabled.  
Activation: only possible from STOP or EDIT.  
Cancellation: by pressing TAPE DUMP a second time or any tape transport function.

|             |                     |
|-------------|---------------------|
| TAPE DUMP C | (No. 329) KEYS ONLY |
| TAPE DUMP D | (No. 330) KEYS ONLY |

- TAPE DUMP C:** TAPE DUMP-mode with preparation switches the right spooling motor off. The tape timer is active and the required information is supplied by the capstan motor tacho.
- TAPE DUMP D:** The tape timer is disabled.  
Activation: only possible from STOP or EDIT. Preparation with TAPE DUMP, start of the TAPE DUMP-mode with PLAY, interruption with STOP.  
Cancellation: by pressing TAPE DUMP a second time or any tape transport function.

|        |                     |
|--------|---------------------|
| LIFTER | (No. 332) KEYS ONLY |
|--------|---------------------|

Also refer to the functions LIFTER REMOTE A/B No. 257 and LIFTER LOCAL A/B No. 258.

In wind mode, activating this function causes the lifter pin to be retracted and the rollers to engage so that the tape contacts the reproduce head and the modulation becomes audible. Momentary-action key. If AUTO MUTE is selected, muting will be cancelled for as long as the tape contacts the heads.

Activation: in REWIND, FORWARD, LOC AND ROLLBACK mode.

Cancellation: by releasing the LIFTER key.



LAP/WATCH DISPLAY (No. 334) KEYS ONLY

Function to activate a second timer, LAP/WATCH.

Press WATCH to switch over to the LAP/WATCH timer. The LAP/WATCH timer status is indicated through an "L" as the first digit. Both timer, normal a LAP/WATCH can be reset independently from each other.

RESET TIMER (No. 335) KEYS ONLY

Function to RESET the actual timer.

Press RESET TIMER to set the tape timer or if selected, the LAP-timer to zero "0.00.00.0".

SET TIMER (No. 336) KEYS ONLY

Function to modify the content of the normal timer or LAP-timer.

Press SET TIMER to get the display for setting. Use the CURSOR-keys to select the position (hours. min. sec. dsec). The desired time value can be entered now by using the SET/CUE-wheel. Press STORE afterwards.

Cancellation: press SET TIMER again, SET ADDRESS, SET VARISPEED, VARISPEED, LOC1..5, LOCSTART or ROLLBACK.

SET ADDRESS (No. 337) KEYS ONLY

Function to refresh the LOCATOR-memory.

Press SET ADDRESS to get the display for setting. Use the CURSOR-keys to select the position (hours. min. sec. dsec). The desired time value can be entered now by using the SET/CUE-wheel. Press TRANS and one of the LOC-memories. The LOC1 (e.g.) contains now a new address.

Cancellation: press SET ADDRESS again, SET TIMER, SET VARISPEED, VARISPEED, LOC1..5, LOCSTART or ROLLBACK.

SET VARISPEED (No. 338) KEYS ONLY

Function to change the VARISPEED in IPS/HT or % depend on the display format.

Press SET VARISPEED to get the display for setting. The selected nominal speed appears in the display. Use the SET/CUE-wheel to change the speed of the capstan motor. The range varies between -35.15% and +54.22% (-7.5 half tones and +7.5 half tones HT).

The new speed becomes active only with the function VARISPEED.

Cancellation: press SET VARISPEED again, SET TIMER, SET ADDRESS or VARISPEED.

|                  |                     |
|------------------|---------------------|
| VARISPEED ON/OFF | (No. 339) KEYS ONLY |
|------------------|---------------------|

Activates the variable speed control, VARISPEED.  
Press VARISPEED to get the message VARISPEED on the display with a corresponding status about the actual speed deviation. The deviation can be displayed in %, HT (half toues) and IPS (inches per second). The value of the deviation can be entered by using SET VARISPEED.

Cancellation: press VARISPEED ON/OFF again

|                      |                     |
|----------------------|---------------------|
| REMOTE A R. CTL ONLY | (No. 345) KEYS ONLY |
|----------------------|---------------------|

Activates the parallel and/or serial remote control; the local keypad is disabled.  
Selection: in STOP mode, provided the STOP key does not flash.  
Cancellation: by pressing this key a second time or by switching off the tape recorder.

**Note:** If neither REMOTE A nor REMOTE B is assigned to a key, the local and the remote keypads are equivalent, corresponding to "REMOTE B active".  
The REMOTE key (F345 or F346) also activates the RS232 serial interface. The REMOTE key must therefore be pressed for operation with the TLS 4000.

|                    |                     |
|--------------------|---------------------|
| REMOTE B REM+LOCAL | (No. 346) KEYS ONLY |
|--------------------|---------------------|

Activates the parallel and/or serial remote control; the local keypad remains operational.  
Activation: in STOP mode, provided the STOP key does not flash.  
Cancellation: by pressing this key a second time or by switching off the tape recorder.

**Note:** If neither REMOTE A nor REMOTE B is assigned to a key, the local and the remote keypads are equivalent, corresponding to "REMOTE B active".  
The REMOTE key (F345 or F346) also activates the RS232 serial interface. The REMOTE key must therefore be pressed for operation with the TLS 4000.

|             |                     |
|-------------|---------------------|
| SHUTTLE BAR | (No. 347) KEYS ONLY |
|-------------|---------------------|

Key for storing a SHUTTLE wind speed selected with the SHUTTLE wheel.  
Activation: during the actuation of the SHUTTLE wheel.  
Cancellation: by all tape transport functions, LOC and ROLLBACK functions.

|        |                     |
|--------|---------------------|
| UNLOAD | (No. 348) KEYS ONLY |
|--------|---------------------|

UNLOAD retracts the pinch roller assembly and switches off the tape tension control.

|             |                     |
|-------------|---------------------|
| NO FUNCTION | (No. 351) KEYS ONLY |
|-------------|---------------------|

NO FUNCTION can be assigned to unused keys.

2.6.3 Programming Examples

Example 1: Set reel diameter to 14"

| Operator action  | Service display indicates                |
|--|--|
| Enable the MENU-entry lock [4]<br>(use allen key size 2,5) |  |
| Switch machine to STOP                                     | L RANGE ../.. dBm<br>NRS: TC:            |
| ↓/NEXT   | USER SET UP<br>ALIGNMENT MODE            |
| ↓/NEXT   | ALIGNMENT<br>DECK AUX                    |
| ↓/NEXT   | SET LIBR WND SPEED<br>05.0 m/s           |
| ↓/NEXT   | SET MAX WIND SPEED<br>15.0 m/s           |
| ↓/NEXT   | SET ROLLBACK TIME<br>15 sec              |
| ↓/NEXT   | MAX REEL DIAMETER<br>SET: 12.5" (318 mm) |
| Set desired diameter with the<br>SET/CUE wheel             | MAX REEL DIAMETER<br>SET: 14" (356 mm)   |
| Press STORE  |  |
| Press<br>↑ / LAST 6 times                                  | L RANGE ../.. dBm<br>NRS: TC:            |
| or   |  |
| proceed to next setup with ↓                               | SET PLAY TENSION<br>LEFT: RIGHT:         |

**Example 2:** Set metering to PPM characteristic (function 053):

| Operator action   | Service display indicates                           |
|---|---|
| Turn the programming lock [...] to the counterclockwise limit position (Allen key size 2.5) |   |
| Switch machine to STOP  | L RANGE ../.. dBm<br>NRS: TC:                       |
| ↓/NEXT  | USER SET UP<br><u>ALIGNMENT</u> MODE                |
| →/CURSOR  | USER SET UP<br>ALIGNMENT <u>MODE</u>                |
| ↓/NEXT  | KEY / MODE SETTING<br><u>AUDIO</u> DECK TC          |
| ↓/NEXT  | AUDIO<br><u>KEYS/MODE</u> KEYS ONLY                 |
| ↓/NEXT  | F009 0/1 no key<br>L RANGE 0/6 dBm Y/N              |
| Page to function 053 with the SET/CUE wheel   | F 053 <u>1</u> /0 no key<br>METERING <u>VU</u> /PPM |
| Change over with STORE  | F 053 0/ <u>1</u> no key<br>METERING VU/ <u>PPM</u> |
| Press<br>↑ / LAST 4 times   | L RANGE ../.. dBm<br>NRS: TC:                       |

**Example 3:** Reprogramming the RESET TIMER key (key 41, function 335) to the REVERSE PLAY function (No. 305):

| Operator action   | Service display indicates                  |
|---|--|
| Turn the programming lock [...] to the counterclockwise limit position (Allen key size 2.5) |  |
| Switch machine to STOP  | L RANGE ../.. dBm<br>NRS: TC:              |
| ↓/NEXT  | USER SET UP<br><u>ALIGNMENT</u> MODE       |
| →/CURSOR  | USER SET UP<br>ALIGNMENT <u>MODE</u>       |
| ↓/NEXT  | KEY / MODE SETTING<br><u>AUDIO</u> DECK TC |
| →/CURSOR  | KEY / MODE SETTING<br>AUDIO <u>DECK</u> TC |
| ↓/NEXT  | TAPE DECK<br><u>KEYS/MODE</u> KEYS ONLY    |
| →/CURSOR  | TAPE DECK<br>KEYS/MODE <u>KEYS ONLY</u>    |
| ↓/NEXT  | F301 L07,R27<br>REWIND                     |
| Page to function 305 with the SET/CUE wheel   | F305 no key<br>REVERSE PLAY                |
| Press STORE   | F305 PRESS 2nd KEY<br>REVERSE PLAY         |
| While holding the STORE key, also press the RESET TIMER key                                 | F305 key assigned<br>REVERSE PLAY          |
| Change the lettering on the key   |  |
| Press<br>↑ / LAST 4 times   | L RANGE ../.. dBm<br>NRS: TC:              |

## 2.6.4 How to perform a software up-date

---

An A820 MCH has 5 microprocessor-units with a total of 10 EPROMs.

|               |   |          |
|---------------|---|----------|
| Capstan MPU   | : | 1 EPROM  |
| Tape Deck MPU | : | 2 EPROMs |
| Master MPU    | : | 3 EPROMs |
| Audio MPU     | : | 3 EPROMs |
| Panel MPU     | : | 1 EPROM  |

Only the Master MPU and Audio MPU are storing important parameters. The Master-RAM holds parameters for Tape Deck (Tape Tensions etc.) and the key assignment.

The Audio-RAM holds all the audio-parameters for a max. of 48 channels. (i.e. Tape A and Tape B or 2 Headblocks 24 channel or 24ch/16ch and a 8 channel configuration).

**Preparatory steps** Write the following parameters down:

- Master:
  - Tape Tension parameters
  - Key assignment (if not default)
 We recommend to write down notes into the "status tree", section 2.6
- Audio:
  - Audio parameters can be stored on tape (see section 4.7) the charts in section 4.1.7 can be used if audio parameters should be written down.
  - Panel setting (Channel setting memory) see last paragraph in section 2.4.5

- Perfoming the up-date**
1. Step: change the EPROMs.  
(lift them off by using a screwdriver No.2)
  2. Step: erase the RAM.  
(short-circuit each pin-side of the RAM by using a screwdriver No.2)
  3. Step: load all audio parameters back from tape.
  4. Step: set the machine up as it was before (key assignment).

## 2.7 Degraded Operation

---

This Section describes the steps to be taken if any faults occur within individual modules.

**Important:** If any fault occurs, the machine should always be switched off for approximately 10 seconds and then powered on again. If the same error messages reoccurs, one of the remedies described in 2.7.1 will have to be taken.  
If any faults occur, the tape recorder should be operated only if absolutely necessary and be repaired or forwarded to the nearest service center as soon as possible.

### 2.7.1 Error Messages of the Service Display

---

There are three error categories:

- **ERRORS OF THE CATEGORY 1** are faults that make it impossible to operate the equipment (e.g. hardware malfunctions). Such an error message can only be reset by switching the machine off and switching it on again after approx. 10 seconds. If the error reappears, it must be remedied, if not the tape recorder should function correctly.
- **ERRORS OF THE CATEGORY 2** adversely affect the operation of the machine, however degraded operation is still possible. Error messages of this category remain on the display for information purposes even when the cause of the malfunction has disappeared. The error message can be cancelled by pressing the STORE key. If the malfunction persists, the message will reappear and can be cancelled again (if necessary), as described above. The machine can still be operated.
- **ERRORS OF THE CATEGORY 3** also influence the function of the machine, but degraded operation is possible. The error message is automatically cancelled when the source of the error disappears. If the LC display is needed for other purposes (e.g. varispeed indication), the error message can be cancelled by pressing STORE even though the error may possibly persist.

#### CATEGORY 1

Display:

ERR: SUPPLY  
VOLTAGE

**Recorder:** switches to STOP, does not respond to keys

**Cause:** One (or several) supply voltages are missing (Signal T-SUPVON missing).

**Remedy:** The FUSE/SUPPLY VOLTAGE FAILURE DETECTOR 1.820.866 indicates which voltage(s) are missing or out of range.

- Switch off the tape recorder
- Check the secondary fuses and replace them, if necessary.
- Repair or replace the corresponding SWITCHING STABILIZER PCB:
  - 1.820.871 ( $\pm 15V$ ), or 1.820.873 ( $\pm 15V$ )
  - 1.820.872 (+ 5.6 V,  $\pm 27 V$ , + 24 V)

**Display:**

ERR: EPROM 1

ERR: EPROM 2

ERR: EPROM 3

**Cause:** Fault in one of the three EPROMs on the MASTER MPU 1.820.784.

- Remedy:**
- Switch the tape recorder off and on. If the message does not reappear, continue to work with the machine.
  - Replace the software: 3 Eproms (IC 15, 16, 18)

**Display:**ERR: MASTER DATA  
LOST**Cause:** Tape tension data lost, key assignment lost

- Remedy:**
- Switch the tape recorder off and on. The default parameters are now loaded, the error message disappears.
  - Check the buffer battery on the MASTER MPU 1.820.784 and replace it, if necessary.
  - Check the supply voltages.

**Display:**ERR: NO COMMUNICAT.  
MASTER-TAPE DECK

- Cause:**
- No feedback to status request.
  - Software of the MASTER MPU 1.820.784 and TAPE DECK MPU 1.820.781 not compatible.

- Remedy:**
- Replace the MASTER SERIAL INTERFACE 1.820.753 and/or the TAPE DECK SERIAL INTERFACE 1.820.763
  - Replace the software: 3 Eproms on each MPU card (IC 15, 16, 18)

**Display:**ERR: TACHO  
SENSOR**Recorder:** switches to STOP**Cause:** No output signal from one of the three tacho sensors (SPOOLING MOTORS 1.820.771, MOVE SENSOR 1.820.770), the three directions of rotation do not agree or no tacho signal of the spooling motors with motor current > 4 A.

- Remedy:**
- Check the flat cable connectors to the sensors.
  - Check the sensors and replace them, if necessary
  - Check that the spindles and the tacho roller rotate without binding.

**Display:**ERR: TAPE TENSION  
CONTROL**Cause:** Deviation of the tape tension from the reference is too large for approx. 1 second.**Remedy:** Check whether the friction of the tape transport and the spindle is too large.



**Display:**

ERR: NO COMMUNICAT.  
CAPSTAN-TAPE DECK

**Recorder:** Switches to STOP.

- Cause:**
- No data exchange via the parallel interface of the CAPSTAN INTERFACE 1.820.727.
  - Capstan processor does not start.
  - Remedy: replace the CAPSTAN INTERFACE.

**Display:**

ERR: MOVE-SENSOR  
HARDWARE

**Recorder:** Switches to STOP.

**Cause:** MOVE SENSOR PCB 1.820.770 or MOTOR TACHO PCB 1.820.771 defective or too frequent direction changes detected.

**Remedy:** replace, repair, or realign (refer to section 3.3.3 and 3.3.11).

**Display:**

ERR: NO COMMUNICAT.  
MASTER-AUDIO

- Cause:**
- Status request is not answered.
  - The software of the MASTER MPU 1.820.784 and the AUDIO MPU 1.820.782 are not compatible.

- Remedy:**
- Replace the MASTER AUDIO INTERFACE 1.820.756 and/or the COMMUNICATIONS CONTROLLER 1.820.718.
  - Replace the software: 3 Eproms on each MPU card (IC 15, 16, 18)

**Display:**

ERR: SPOOLING MOTOR  
TACHO LEFT

**Cause:** Left Spooling Motor tacho 1.820.771 shows too frequent direction changes or no tacho signal.

**Remedy:** Replace, repair or realign (if possible).

**Display:**

ERR: SPOOLING MOTOR  
TACHO RIGHT

**Cause:** Right Spooling Motor tacho 1.820.771 shows too frequent direction changes or no tacho signal.

**Remedy:** Replace, repair or realign (if possible).

**Display:**

ERR: SPOOLING MOTOR  
SERVO HARDWARE

**Cause:** Fault in the analog control circuit of the spooling motors or voltage missing or current feedback open.

- Remedy:** Check voltages and signal on the following PCBs:
- Move Sensor 1.820.770
  - Sp. Motor Drive Amp. 1.820.875
  - Tape Tension Sensors 1.820.772 / 1.820.877

CATEGORY 2**Display:**

|                        |
|------------------------|
| ERR: POWER<br>DROP OUT |
|------------------------|

**Recorder:** Switches to STOP.**Cause:** Transient line voltage failure > 100 ms (Signal T-PWRON)**Remedy:** Acknowledge with STORE.CATEGORY 3**Display:**

|                                  |
|----------------------------------|
| ERR: MOTOR SUPPLY<br>VOLTAGE LOW |
|----------------------------------|

**Cause:** Spooling motor supply voltage failure (Signal PWMPR-L6)**Remedy:** Wait 10 seconds. If the error persists:

- Switch the tape recorder off.
- Check fuses F1 and F2 (next to the power-on switch) and replace, if necessary.
- Repair or replace the SPOOLING MOTOR DRIVE AMPLIFIER 1.820.875.

**Display:**

|                                      |
|--------------------------------------|
| ERR: INCORRECT<br>RADIUS MEASUREMENT |
|--------------------------------------|

**Recorder:** Switches to STOP.**Cause:**

- The computed radius of the tape pancakes is not within the admissible limits.
- Tacho sensors defective.

**Remedy:**

- Switch the recorder (with tape) to PLAY for a few seconds. This message normally disappears as soon as sufficient tacho pulses for computing the pancake radius are available.
- Check the tacho sensors, repair or replace them.
- Set 'Max. Reel Size' in the ALIGNMENT DECK block of the software menu to 14".

**Display:**

|                               |
|-------------------------------|
| ERR: SHUTTLE VALUE<br>INVALID |
|-------------------------------|

**Cause:** Incorrect values have been supplied by the SHUTTLE potentiometers during the initialization phase.**Remedies:**

- The SHUTTLE wheel may not be actuated during the initialization of the machine.
- Readjust the SHUTTLE potentiometer (refer to section 3.3.12).

**Display:**

ERR: PINCH ROLLER  
SLIPPING

**Recorder:** Switches to STOP.

**Cause:** Excessive slip of pinch roller; capstan speed does not agree with the tape speed.

- Remedy:**
- Clean the pinch roller and the capstan shaft, replace the pinch roller, if necessary
  - Adjust the pinch roller force to the correct value.

**Display:**

ERR: INCORRECT  
INERTIA

**Recorder:** Switches to STOP.

**Cause:** The last three inertia computations produced inadmissible values.

**Remedy:** Check that all rollers and motors rotate without binding and that the tape travels smoothly through all the guidance elements, and that the reel diameter has been set correctly (MAX. REEL DIAMETER) in the ALIGNMENT DECK block of the software menu.

**Display:**

ERR: NOT IDENTIFIED

**Cause:** Unknown fault.

- Remedy:**
- Switch the recorder off and on again. The machine can be used normally if the error message does not reappear.
  - Unplug and reinsert the RAM (IC 8) of the MASTER MPU 1.820.784.

**Important:** The tape tension data and the key programming are lost, and the default parameters are loaded in their place!

- Either continue to operate with the default data,
- Load the parameters specified in the log, or
- Recalibrate the tape tensions.

**Display:**

ERR: AUDIO EPROM 1

ERR: AUDIO EPROM 2

ERR: AUDIO EPROM 3

**Cause:** Fault in one of the three EPROMs on the AUDIO MPU 1.820.782.

- Remedy:**
- Switch the tape recorder off and on. The machine can be used normally if the message does not reappear.
  - Replace the software: 3 Eproms (IC 15, 16, 18)

**Display:**

ERR: AUDIO DATA  
LOST

**Cause:** Audio data lost

- Remedy:**
- Switch the tape recorder off and on. The default parameters are now loaded, the error message disappears.
  - Check the buffer battery on the AUDIO MPU 1.820.782 and replace it, if necessary.
  - Continue to work either with the default parameters (minor deviations from the optimum frequency response are unavoidable), or
  - Load the parameters saved on tape, or
  - Recalibrate the machine.

**Display:**

ERR: NO DATA FOUND  
ON TAPE

**Cause:** Backup stored on tape not readable.

- Remedy:**
- Check the input signal (level and shape). The yellow LED (LEVEL) on the COMMUNICATIONS CONTROLLER 1.820.718 should be on. Adjustable with the nearby potentiometer.

**Display:**

ERR: DEFAULT AUDIO  
PAR LOADED

**Cause:** The default parameters have been loaded after a loss of audio data.

- Remedy:**
- Reload the audio data from tape or recalibrate the machine.

**Display:**

ERR: VERIFY FAILED

**Cause:** The data read from tape do not agree with the machine data.

- Remedy:**
- Reload the audio data from tape because an error has occurred during the previous load operation.

**Display:**

ERR: HEAD NOT  
IDENTIFIED

**Cause:** Machine switched on with no head block mounted or wrong identification code coming from the Head Assembly Identifier PCB 1.820.795.00 (on the head block).

- Remedy:**
- Put head block on the machine or check Head Assembly ID PCB.

## 2.7.2 Additional Messages of the Service Display (Warnings)

---

**Headblock Exchange:** e.g. After a headblock exchange from 24 to 16ch has been carried out, the audio and tape tension parameters as well as the key assignment are changed automatically to the default values. The display shows:

WARN: DEFAULT KEYS  
& PARAMETER LOADED

To save the key assignment, activate the function "SAVE KEY SETTING" No. 246 in the menu before the headblock is removed. The display shows only:

WARN: DEFAULT  
PARAMETER LOADED

- **DEFAULT KEYS:** means having the default key assignment (changes with the headblock for 24/16 or 8ch).
- **DEFAULT PARAMETER:** means having the default tape tension parameters (changes with the headblock for 1" and 2" format).

**Display:**

WARN: REFERENCE  
FREQUENCY WRONG

**Recorder:** Does not achieve the selected nominal speed in PLAY mode.

**Cause:** The frequency of the external varispeed reference signal is outside the admissible range (6.4 kHz to 14.4 kHz), or the signal is missing.

**Remedy:** Correct the reference signal.

**Remarks:** The keep the DEFAULT KEYS confirm the assignment of only one key to get the message as shown above. The same can be done with the DEFAULT PARAMETER\* for the tape tensions. Confirm one Hex-value in the alignment section of the menu with STORE to get no message "WARNING..." anymore.

\*=message

## 2.8 Operation with Serial Interfaces

- The version Serial Remote Controller 1.810.751 supports the ASCII-protocol in RS 232 standard and is needed for the communication with the TLS4000 synchronizer or a Personal Computer.
- The version SMPTE/EBU – Interface 1.820.751 supports the SMPTE/EBU-protocol in RS232 or RS422 standard (selectable with Jumper).

### 2.8.1 RS 232 and RS 422 Interface Standard

**RS 232** The term "RS232" defines a connection between two points. This standard also defines:

- electrical characteristics (lines, level)
- mechanical characteristics (connectors)
- signal descriptions
- standard connections

**Lines** The interface supports data rates up to 19,2 kBaud (for A820 MCH: 9,6 kBaud) and cable lengths up to 15m.

**Level** The levels are defined as follows:

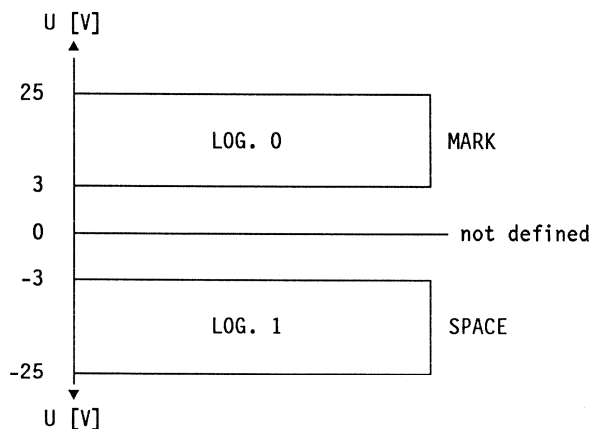

**Connection** The connections for the asymmetrical standard RS 232:

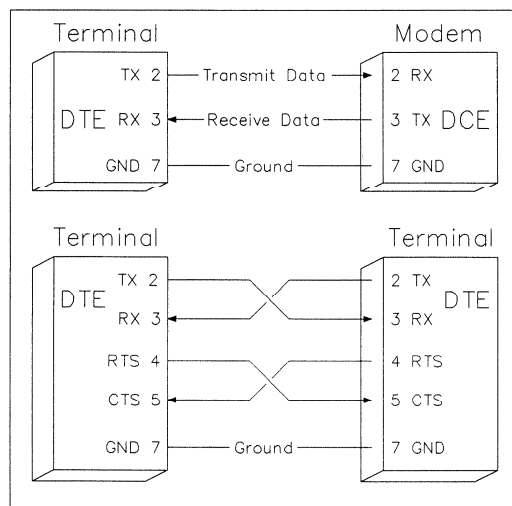

- connection between a terminal and a modem.  
(no handshake lines parallel wired)
- connection between two points without modem.  
(with handshake lines and usually crossed)

The serial remote interface of the A820 MCH uses the two 9-pin connectors according to SMPTE/EBU rather than the 25-pin connector. The user can thus define whether the unit is used as a terminal or as a modem.

| RECORDER<br>9-pin |   | TERMINAL<br>25-pin |   | MODEM<br>25-pin |   |
|-------------------|---|--------------------|---|-----------------|---|
| SNDATA            | 2 | TRANS. DATA        | 2 | TRANS. DATA     | 3 |
| RCVDATA           | 8 | REC. DATA          | 3 | REC. DATA       | 2 |
| GROUND            | 9 | SIG. GROUND        | 7 | SIG. GROUND     | 7 |

No additional handshake lines are used. A software handshake (X on / X off-protocol) is implemented for all Baud-rates, but only necessary for 9,6 kBaud.

X on = 0001 0001 (ASCII DC1) → continue

X off = 0001 0011 (ASCII DC3) → interrupt

**RS 422** The term "RS422" defines a connection between two points. This standard is symmetrical in contrast to the asymmetrical RS232.

**Lines** The interface "SMPTE/EBU 1.820.751" supports data rates with 38,4 kBaud and cable lengths up to 1200m.

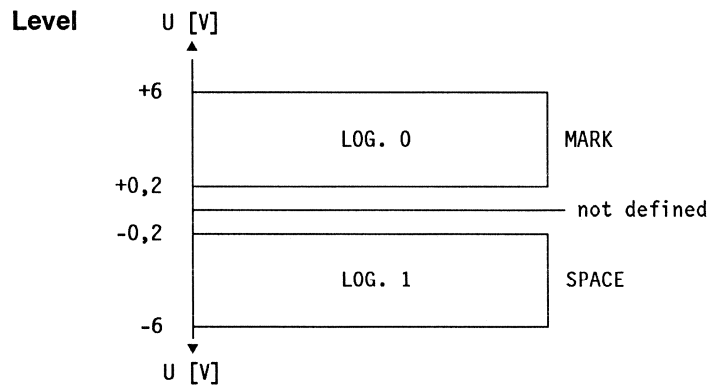

The SMPTE/EBU - interface 1.820.751 uses the two 9-pin connectors according to SMPTE/EBU rather than the 25-pin connector.

**Connection** The connection for the symmetrical standard RS422:

| RECORDER<br>9-pin |   |
|-------------------|---|
| SHIELD            | 1 |
| TRANSMIT A        | 2 |
| RECEIVE B         | 3 |
| RECEIVE COMMON    | 4 |
| -                 | 5 |
| TRANSMIT COMMON   | 6 |
| TRANSMIT B        | 7 |
| RECEIVE A         | 8 |
| SHIELD            | 9 |

## 2.8.2 Installation of the Serial Remote Controller 1.810.751

\*THIS BOARD USES THE ASCII-PROTOCOL\*

- Standard Set Up:**
- 1 Stop bit
  - 1 Start bit
  - 8 Data bits
  - NO parity bit
  - NO echo mode
  - 9600 Baud
  - Jumper H

The interface can send/receive either in a NRZ-format (non return to zero) or in a Bi-phase-format.

- NRZ-format with the ASCII-protocol.
- Bi-phase-format with the ASCII-protocol.

The format depends on the application or the specification from the manufacturer.

- Connect the computer or the terminal via the adapter cable to one of the two 9-pin RS232 sockets on the rear of the A820MCH. If the connection is correct, the RX and the TX LEDs turn dark.
- Program the baud rate to match the computer or terminal.  
After a RESET (switching the A820 MCH off and on again) the display shows:

```
***** A820 MCH MONITOR *****
***** ALL PROCESSES STARTED *****
```

The desired commands (see command list below) can be entered via the keyboard of the terminal. The commands are executed when the line feed key (enter or line feed) is pressed.

- Important:**
- Only upper case characters are accepted!
  - The REMOTE function (No. 345 or 346) has to be active!



Command list

| TAPE DECK COMMANDS                                    |   |  |
|---|---|--|
| Command<br>(_ = blank,<br>7 = CR, * =<br>blank or CR) | Response of<br>the tape<br>recorder   | Description  |
| STP*  | <CR><LF>  | Stop   |
| RWD*  | <CR><LF>  | Rewind   |
| FWD*  | <CR><LF>  | Fast forward   |
| PLY*  | <CR><LF>  | Play   |
| RPL*  | <CR><LF>  | Reverse play   |
| REC*  | <CR><LF>  | Record (directly, without preceding PLAY command)  |
| EDI*  | <CR><LF>  | Edit   |
| SSA*  | <CR><LF>  | Select tape speed 3.75 ips (>4/91 SW)  |
| SSB*  | <CR><LF>  | Select tape speed 7.5 ips  |
| SSC*  | <CR><LF>  | Select tape speed 15 ips   |
| SSD*  | <CR><LF>  | Select tape speed 30 ips   |
| SVP_<XXXX>  | <CR><LF>  | Set varispeed parameter<br>00A5FE <= XXXXXX <= 01BACE (hex)<br>parameter refers to nominal speed, signless,<br>independent of td status, 010000=nominal<br>(fixed) speed |
| WNR_<XXXX>  | <CR><LF>  | Rewind with selectable speed<br>(0 ≤ XXXX ≤ 5FFF)  |
| WNF_<XXXX>  | <CR><LF>  | Spool forward with selectable speed<br>(0 ≤ XXXX ≤ 5FFF)   |
| NS?*  | 7.5 IPS <CR><br><LF>, oder<br>15 IPS<CR><LF><br>oder<br>30 IPS<CR><LF><br>xx IPS<CR><LF><br>xx =3.75, 7.5,<br>15, or 30 | Read out the nominal speed   |
| VS?*  | xxxxxx<CR><LF>  | Varispeed parameter?<br>00A5FE <= xxxxxx <= 01BACE (hex)<br>parameter refers to nominal speed, signless,<br>independent of td status, 010000 = nominal<br>(fixed) speed  |
| SVS*  | <CR><LF>  | Varispeed on   |
| CVS*  | <CR><LF>  | Varispeed off  |
| VEN*  | <CR><LF>  | External varispeed on  |
| VEF*  | <CR><LF>  | External varispeed off   |
| FEN*  | <CR><LF>  | FADER START ENABLE ON  |
| FEF*  | <CR><LF>  | FADER START ENABLE OFF   |
| LOC_<address>   | <CR><LF>  | Spool to <(-)hh(:)( )mm(:)( )ss(:)( )n><br>(n = 1/10 second)<br>e.g. LOC_01:20:15:0<br>LOC_-00_35_25_1   |
| LMV_<T.-count>  | <CR><LF>  | Spool according to the tacho roller signals<br><XXXXXXXX>, 4 Bytes HEX<br>z.B. LMV_00AE4F00  |
| MV?*  | XX XX XX XX<br><CR><LF><br>4 Bytes HEX  | Read out the tacho roller signals  |
| STM_<address>   | <CR><LF>  | Set counter to (-)hh(:)( )mm(:)( )ss(:)( )nnn<br>(nnn = milliseconds)<br>(-9:59:59:999 ≤ address ≤ 23:59:59:999)<br>e.g. STM_01_20_15_000<br>STM_-00:35:25:125           |
| TM?*  | hh:mm:ss:z<br><CR><LF>, or<br>-hh:mm:ss:z<br><CR><LF><br>z = 1/10 sec   | Read out the tape timer<br>u = underflow,<br>o = overflow  |

Continued on next page

| TAPE DECK COMMANDS                                       |   |   |
|--|---|---|
| Command<br>( = blank, * =<br>7 = CR, * =<br>blank or CR) | Response of<br>the tape<br>recorder   | Description   |
| DST*   | <CR><LF>< hh:m<br>m:ss:z Y XXXXX<br>XXXXXXXXXXXX><br>z = 1/10 Sek.<br>Y= Status,<br>1 Byte HEX<br>X = Status im<br>Klartext, z.B.<br>PLAY | Display the equipment status on the screen<br>and update it continually<br>(Cancel with CNTL X) |
| SD?*   | dd:ww:yy <CR><br><LF>   | Software date?  |
| ST?*   | X<CR><LF><br>X = 1 Byte HEX   | Status inquiry<br>e.g.:   |
|  | X = 01  | TAPE OUT  |
|  | X = 81  | TAPE OUT ACHIEVED   |
|  | X = 02  | STOP NOT ACHIEVED   |
|  | X = 82  | STOP ACHIEVED   |
|  | X = 03  | REWIND NOT ACHIEVED   |
|  | X = 83  | REWIND ACHIEVED   |
|  | X = 04  | FORWARD NOT ACHIEVED  |
|  | X = 84  | FORWARD ACHIEVED  |
|  | X = 05  | PLAY NOT ACHIEVED   |
|  | X = 85  | PLAY ACHIEVED   |
|  | X = 06  | PLAY VARISPEED NOT ACHIEVED   |
|  | X = 86  | PLAY VARISPEED ACHIEVED   |
|  | X = 07  | PLAY INT. REF. NOT ACHIEVED   |
|  | X = 87  | PLAY INT. REF. ACHIEVED   |
|  | X = 08  | PLAY EXT. REF. NOT ACHIEVED   |
|  | X = 88  | PLAY EXT. REF. ACHIEVED   |
|  | X = 09  | RECORD NOT ACHIEVED   |
|  | X = 89  | RECORD ACHIEVED   |
|  | X = 0B  | EDIT NOT ACHIEVED   |
|  | X = 8B  | EDIT ACHIEVED   |
|  | X = 25  | REVERSE PLAY  |
|  | X = A5  | REVERSE PLAY ACH.   |
|  | X = 26  | REVERSE PLAY VARI   |
|  | X = A6  | REVERSE PLAY VARI ACH.  |
|  | X = 27  | REVERSE PLAY INT REF  |
|  | X = A7  | REVERSE PLAY INT REF ACH.   |
|  | X = 28  | REVERSE PLAY EXT REF  |
|  | X = A8  | REVERSE PLAY EXT REF ACH.   |
|  | X = 29  | REVERSE REC OR  |
|  |   | REHEARS REVERSE REC   |
|  | X = A9  | REVERSE RECORD ACH.   |
|  |   | OR REH REV REC ACH.   |
|  | X = 40  | SHUTTLE BACKWARD  |
|  | X = C0  | SHUTTLE BACHWARD ACHIEVED   |
|  | X = 41  | SHUTTLE FORWARD NOT ACHIEVED  |
|  | X = C1  | SHUTTLE FORWARD ACHIEVED  |
|  | X = 42  | LOCATE WIND REVERSE NOT ACHIEVED  |
|  | X = C2  | LOCATE WIND REVERSE ACHIEVED  |
|  | X = 43  | LOCATE WIND FORWARD NOT ACHIEVED  |
|  | X = C3  | LOCATE WIND FORWARD ACHIEVED  |
|  | X = 44  | LOCATE PLAY REVERSE NOT ACHIEVED  |
|  | X = C4  | LOCATE PLAY REVERSE ACHIEVED  |
|  | X = 45  | LOCATE PLAY FORWARD NOT ACHIEVED  |
|  | X = C5  | LOCATE PLAY FORWARD ACHIEVED  |
|  | X = 46  | CUEING REVERSE NOT ACHIEVED   |
|  | X = C6  | CUEING REVERSE ACHIEVED   |
|  | X = 47  | CUEING FORWARD NOT ACHIEVED   |
|  | X = C7  | CUEING FORWARD ACHIEVED   |
|  | X = 48  | POSITION PLAY REVERSE NOT ACHIEVED  |
|  | X = C8  | POSITION PLAY REVERSE ACHIEVED  |
|  | X = 49  | POSITION PLAY FORWARD NOT ACHIEVED  |
|  | X = C9  | POSITION PLAY FORWARD ACHIEVED  |
|  | X = 4A  | REWIND CONTROLLED NOT ACHIEVED  |
|  | X = CA  | REWIND CONTROLLED ACHIEVED  |
|  | X = 4B  | WIND FORWARD CONTROLLED NOT ACHIEVED  |
|  | X = CB  | WIND FORWARD CONTROLLED ACHIEVED  |
|  | X = 59  | TAPE DUMP NOT ACHIEVED  |
|  | X = D9  | TAPE DUMP ACHIEVED  |
|  | X = 5A  | CUT   |
|  | X = DA  | CUT ACHIEVED  |
|  | X = DD  | BURN IN TEST ACHIEVED   |

Continued on next page



| AUDIO COMMANDS   |   |  |
|--|---|--|
| Command<br>(_ = blank, * = CR, * = blank or CR)                    | Response of the tape recorder   | Description  |
| EMC*   | <CR><LF>  | Set enable memory change   |
| DMC*   | <CR><LF>  | Set disable memory change  |
| SNB*   | <CR><LF>  | NAB equalization   |
| SCR*   | <CR><LF>  | CCIR equalization  |
| STA*   | <CR><LF>  | Switch to tape type A  |
| STB*   | <CR><LF>  | Switch to type type B  |
| MSN*   | <CR><LF>  | MASTER SAFE on   |
| MSF*   | <CR><LF>  | MASTER SAFE off  |
| SRH*   | <CR><LF>  | REHEARSAL (Schnittprobe) ein   |
| CRH*   | <CR><LF>  | REHEARSAL off  |
| DDN*   | <CR><LF>  | Drop in/out delay on   |
| DDF*   | <CR><LF>  | Drop in/out delay off  |
| AA?*   | aabbccdd CR LF<br>aa: 0 = Safe<br>1 = Ready/Record<br>bbcc:00 =rep<br>01 =sync<br>1x =input<br>dd: 0 = demute<br>1 = mute | Channel 1..8 status?<br><br>MSB (xx) = Channel 8<br>LSB (xx) = Channel 1<br>xx = aa .. dd  |
| AB?*   | aabbccdd CR LF<br>aa: 0 = Safe<br>1 = Ready/Record<br>bbcc:00 =rep<br>01 =sync<br>1x =input<br>dd: 0 = demute<br>1 = mute | Channel 9...16 status?<br><br>MSB (xx) = Channel 16<br>LSB (xx) = Channel 9<br>xx = aa .. dd   |
| AC?*   | aabbccdd CR LF<br>aa: 0 = Safe<br>1 = Ready/Record<br>bbcc:00 =rep<br>01 =sync<br>1x =input<br>dd: 0 = demute<br>1 = mute | Channel 17...24 status?<br><br>MSB (xx) = Channel 24<br>LSB (xx) = Channel 17<br>xx = aa .. dd   |
| REA i/<br>SAF i/<br>INP i/<br>SYN i/<br>REP i/<br>MTN i/<br>MTF i/ | <CR><LF><br><CR><LF><br><CR><LF><br><CR><LF><br><CR><LF><br><CR><LF><br><CR><LF>  | Channel i READY (i= 1..18 [hex] or FF for all<br>Channel i SAFE (i= 1..18 [hex] or FF for all<br>Channel i INPUT (i= 1..18 [hex] or FF for all<br>Channel i SYNC (i= 1..18 [hex] or FF for all<br>Channel i REPRO (i= 1..18 [hex] or FF for all<br>Channel i MUTE (i= 1..18 [hex] or FF for all<br>Channel i cancel-<br>mute (i= 1..18 [hex] or FF for all |
| CHN i/<br>CHF i/   | <CR><LF><br><CR><LF>  | Channel i on (i= 1..18 [hex] or FF for all<br>Channel i off (i= 1..18 [hex] or FF for all<br><br>(i= 1..18 [hex] or FF for all<br>(FF = all Channel)   |

Additional Table

Index i

| Channel | i [hex] | Channel | i [hex] |
|---------|---------|---------|---------|
| 1       | 01      | 13      | 0D      |
| 2       | 02      | 14      | 0E      |
| 3       | 03      | 15      | 0F      |
| 4       | 04      | 16      | 10      |
| 5       | 05      | 17      | 11      |
| 6       | 06      | 18      | 12      |
| 7       | 07      | 19      | 13      |
| 8       | 08      | 20      | 14      |
| 9       | 09      | 21      | 15      |
| 10      | 0A      | 22      | 16      |
| 11      | 0B      | 23      | 17      |
| 12      | 0C      | 24      | 18      |
|         |         | ALL     | FF      |

| TAPE DECK AND TIMECODE COMMANDS                       |  |  |
|---|--|--|
| Command<br>(_ = blank, * =<br>CR, * =<br>blank or CR) | Response of<br>the tape<br>recorder                              | Description  |
| LCE*  | <CR><LF>   | Built-in keyboard enabled  |
| LCD*  | <CR><LF>   | Built-in keyboard disabled   |
| RME*  | <CR><LF>   | Remote control keyboard enabled  |
| RMD*  | <CR><LF>   | Remote control keyboard disabled   |
| MK?*<br><br>MT?*<br><br>SBA_<address><br>BA?*         | aa <CR><LF><br><br>aa <CR><LF><br><br><CR><LF><br><XXXX><CR><LF> | Mark nr of software version?<br>aa=mark number:<br>00,01, "?" =mark I, 02=mark II<br><br>Machine type?<br>aa=machine type number<br>01=820, 02=812, 03=820MCH,<br>04=827MCH, 05=807, 06=816, 07=810<br><br>Set bus address to <XXXX> (4 HEX digits,<br>8280 ≤ XXXX ≤ FFFF)<br>Read out bus address |

2.8.3 Installation of the SMPTE/EBU- Interface 1.820.751

\*THIS BOARD USES THE SMPTE/EBU- PROTOCOL\*

- Electrical standards according to RS 232C or RS422A (selectable with jumpers)
- Full-duplex
- Asynchronous transmission of the data, bit-serial and word-serial, according to the following diagram:

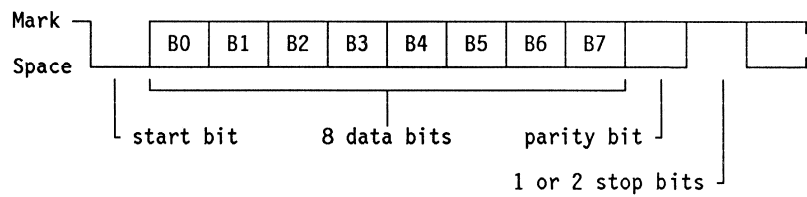

- Odd or even parity and the number of stop bits (1 or 2) can be programmed.
- Baud rates for RS 232 and RS422 programmable as 9600 or 1200 baud, for operation in conjunction with an SMPTE/EBU-bus it is preset to 38400 baud.

Standard Set up:

- RS232
- 1 start bit
- 8 data bits
- even parity
- 1 stop bit
- 9600 baud.

Jumper:

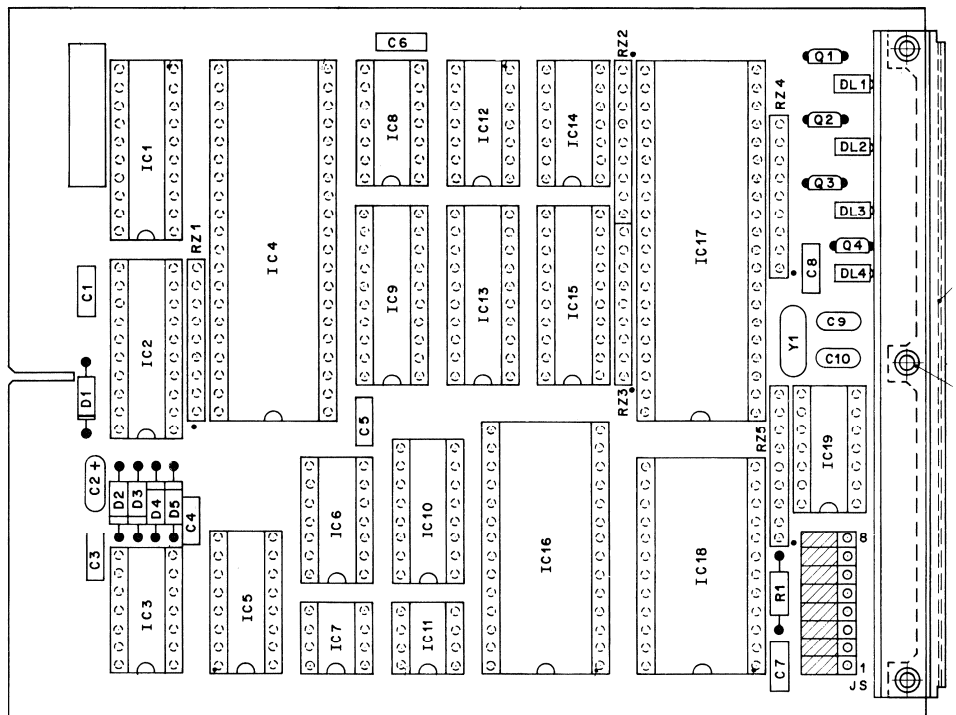

Fig. 2.8.3

|               | J1 | J2 | J3 | J4 | J5 | J6 | J7 | J8 |
|---------------|----|----|----|----|----|----|----|----|
| SMPTE/EBU BUS | BC | BC |    | BC | BC | BC | BC | BC |
| SERIAL RS232  | AB | AB |    | AB | AB | AB | AB | AB |
| SERIAL RS422  | BC | BC |    | AB | BC | BC | BC | AB |

|               |          | J3 |
|---------------|----------|----|
| SMPTE/EBU BUS | 38,4 kBd | BC |
| RS232/RS422   | 9600 Bd  | BC |
|               | 1200 Bd  | AB |

**Status-LED's**

The four status-LEDs on the front bracket of the module 1.820.751 are used for indicating different states, depending on whether the module is used as a serial interface (RS232/RS422) or as an SMPTE/EBU interface (programmable with jumpers as described above).

**SMPTE/EBU bus:**

- INTERFACE SELECTED**  
Is on when the interface receives an SEL ADDR and as long as it remains in the SELECT status.
- INTERFACE POLLED**  
Is on when the interface receives a POLL ADDR and as long as it remain in the POLL status.
- INTERFACE IDLE/ACTIVE**  
Is on as long as the interface waits for STX (control byte).
- FIFO TX/RX ACTIVE**  
Is on when the interface receives data from the FIFO or transmits data to the FIFO.

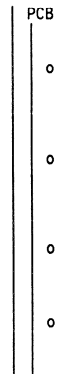

**RS232/RS422:**

- RX ACTIVE**  
Is on as soon as the interface receives STX (control byte) and as long as it receives a message.
- TX ACTIVE**  
Is on as long as the interface transmits a message.
- INTERFACE ACTIVE**  
Is on as long as the interface waits for a BREAK signal or its own answer.
- FIFO TX/RX ACTIVE**  
Is on when the interface receives data from the FIFO or transmits data to the FIFO.

**Software protocol:** The host control system can transmit commands (function or parameter commands) or status requests to the A820 MCH. The A820 MCH acknowledges the commands and supplies status messages on request.

- Commands from the control system to the A820 MCH:

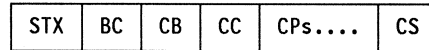

STX: is a control character and is transmitted as a start character (according to SMPTE recommendation: STX = 02H).

BC (byte count): contains the number of bytes that follow (excluding checksum).

CB (control byte):

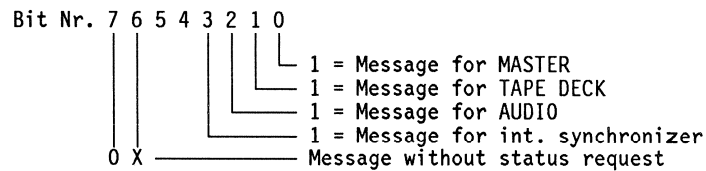

CC (command code): function or parameter command; refer to corresponding instruction set.

CP (parameter bytes): only for parameter commands; if more than one parameter byte exists, the MSB is transmitted first.

CS (checksum): Two's complement of the sum of all data transmitted before the checksum, excluding STX.

- Status request from the control system to the A820 MCH:

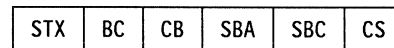

STX: is a control character and is transmitted as the start character (according to SMPTE recommendation: STX = 02H).

BC (byte count): = 3 (fixed). CB (control byte):

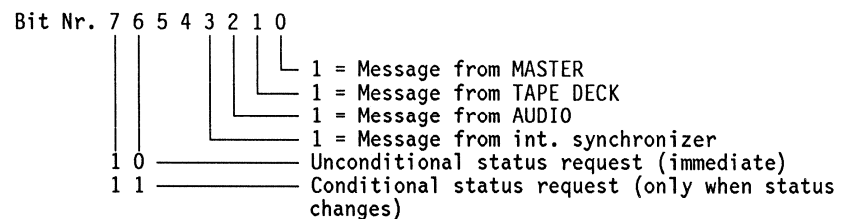

SBA, SBC (status request byte): SBA contains the base address, SBC the number of bytes of the requested status. CS (checksum): two's complement of the sum of all data transmitted before the checksum, excluding STX.

- Acknowledgment and status messages of the A820 MCH to the control system:

After the control system has transmitted a command block, it must wait for an acknowledgment from the A820 MCH before a new command block may be transmitted.

This acknowledgment can consist of a control character or a status message.

If no acknowledgment arrives within the time-out period (10 ms), the control system considers the transmission as faulty.





## 2.9 Care Instructions

### General

Daily care is limited to cleaning the heads, the capstan shaft, and the tape guidance elements.

Dust and oxide particles of the magnetic coating tend to accumulate on the heads and tape guides and can lead to dead gaps (so-called drop-outs).

Cleaning should be performed daily, or if contamination is visible, even more frequently.

Cleaning is best performed with a STUDER cleaning kit (Part No. 10.496.010.00) which contains all utensils required for cleaning the tape recorder, as well as a head cleaning fluid and aluminite cleaner.

**Procedure:** Moisten the yellow piece of cloth with the head cleaning fluid and clean all guidance elements that come in contact with the tape. Then wipe the cleaned parts with a dry section of the yellow piece of cloth.

The capstan shaft normally does not rotate when the recorder is not switched to play mode. A special function is available, however, to put the capstan motor in operation. For this purpose, unthread the tape and press the PLAY key.

**Important:** When you clean the capstan, make sure that no cleaning fluid penetrates into the bearing!

### Capstan motor maintenance

**Capstan:** The capstan motor requires no maintenance. Lubricate the motor every six months with one or two drops of oil type PDP 65 with the aid of the oiler (Part No. 20.020.401.04) to extend the life of the motor.  
1.021.602.00  
1.021.603.00  
no sticker-label

**Capstan:** Capstan motors manufactured after January 1988 (red label on the bottom of the motor) must be lubricated with a few drops of Liquid grease CONSTANT GLY 2100 (Part No. 20.020.401.10).  
1.021.602.81  
1.021.603.81  
red sticker-label

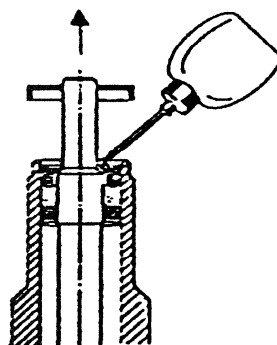

Fig. 2.9

**Capstan:** The new capstan motor is equipped with ball bearings instead of having sinter bearings. This motor needs no oil anymore. Do not apply oil in this case.  
1.021.622.00  
1.021.623.00  
whit sticker-label

### 3. Power Supply, Tape Deck Control

|        |   |    |
|--------|---|----|
| 3.1    | Checks, Adjustments .....   | 1  |
| 3.1.1  | Power Supply .....  | 1  |
| 3.1.2  | Opto Sensor (light gate) 1.820.793 GRP14 .....                                    | 6  |
| 3.1.3  | Move Sensor (tape move sensor) 1.820.770 GRP45.....                               | 7  |
| 3.1.4  | Mechanical Brakes GRP40 (left), GRP41 (right) .....                               | 8  |
| 3.1.5  | Tape Tension Sensor 2" and 1".....  | 10 |
| 3.1.6  | Pinch Roller Assembly.....  | 12 |
| 3.1.7  | Lifter Pin.....   | 14 |
| 3.1.8  | Tape Tension.....   | 15 |
| 3.1.9  | Exchanging and Adjusting the Heads .....  | 17 |
| 3.1.10 | Capstan Motor GRP38.....  | 19 |
| 3.1.11 | Spooling Motor Tacho 1.820.771 GRP36 (left), GRP37 (right) ..                     | 20 |
| 3.1.12 | Cue Sensor (Edit assembly) 1.820.765 GRP49.....                                   | 21 |
| 3.1.13 | LC Display Unit 1.820.233 GRP52 1.820.239.....                                    | 22 |
| 3.1.14 | Adjustments on the Tape Transport Control Boards .....                            | 22 |
| 3.1.15 | Removing the Modules.....   | 23 |
| 3.1.16 | Headblock .....   | 23 |
| 3.1.17 | Covers.....   | 24 |
| 3.1.18 | Push Button Rail.....   | 24 |
| 3.1.19 | Push Button Assembly .....  | 24 |
| 3.1.20 | Service Display.....  | 25 |
| 3.1.21 | Tape Lifter Assembly .....  | 26 |
| 3.1.22 | Tape Tension Sensors.....   | 26 |
| 3.1.23 | Tape-End Sensor (Light Barrier) with Guide Roller .....                           | 27 |
| 3.1.24 | Tape Move Sensor.....   | 27 |
| 3.1.25 | Adapter (inc. Brake Drum).....  | 27 |
| 3.1.26 | Brakes.....   | 28 |
| 3.1.27 | Spooling Motors.....  | 28 |
| 3.1.28 | Capstan Motor.....  | 29 |
| 3.1.29 | Checking the Tape Movement across the Heads of 1" and 2"<br>Machines .....        | 30 |
| 3.1.30 | Checking and adjusting the Tape Transport Elements (ELM) ..                       | 33 |
| 3.1.31 | Fine-Adjustment of the Tape Movement .....  | 43 |
| 3.2    | Circuit Discriptions .....  | 45 |
| 3.2.1  | Power Supply Electronics 1.820.350 GRP01 - GRP14.....                             | 45 |
| 3.2.2  | Power Fail Detector 1.820.791 GRP14 .....   | 45 |
| 3.2.3  | Power Supply Electronics 1.820.353 GRP01 - GRP11.....                             | 46 |
| 3.2.4  | Main Soft Start Unit 1.820.830 .....  | 47 |
| 3.2.5  | +15V/-15V, 24V Stabilizer 1.820.871.81 .....                                      | 48 |
| 3.2.6  | +27V/-27V, +24V, +5.6V Stabilizer .....   | 48 |
| 3.2.7  | +27V/-27V, +24V, +5.6V Stabilizer 1.820.872.82.....                               | 49 |
| 3.2.8  | +15V/-15V, +24V Stabilizer 1.820.873.00 + 1.820.873.81 .....                      | 49 |
| 3.2.9  | Spooling Motor Drive Amplifier 1.820.875.82 GRP20<br>ELM1 (left)/ELM2(right)..... | 50 |
| 3.2.10 | Power Fail Sense Board 1.820.869.00 GRP 23 .....                                  | 51 |
| 3.2.11 | Pinch Roller Gate 1.820.831 GRP 60.....   | 51 |
| 3.2.12 | Move Sensor 1.820.770.81 (GRP20/ELM11) .....                                      | 52 |
| 3.2.13 | Motor Tacho 1.820.771.82 GRP 36 (left) GRP 37 (right).....                        | 53 |
| 3.2.14 | Opto Sensor 1.820.793.82 .....  | 53 |

### 3. Power Supply, Tape Deck Control

#### 3.1 Checks, Adjustments

Order Number

##### Required:

|  |               |
|--|---------------|
| ■ Digital Multimeter                           |               |
| ■ Oscilloscope                                 |               |
| ■ Frequency counter                            |               |
| ■ Spring dynamometer 0 – 5 N (0 to 500 p)      | 10.249.001.01 |
| ■ Spring dynamometer 0 – 20 N (0 to 2 kp)      | 10.249.001.03 |
| ■ Gauge for adjusting the tape tension sensors | 10.010.001.34 |
| ■ Weights for adjusting 1" tape tension sensor | 10.010.001.36 |
| ■ Weights for adjusting 2" tape tension sensor | 10.010.001.35 |
| ■ Guide roller                                 | 10.010.001.38 |
| ■ Tentelometer 1" – 2"                         | 10.300.001.02 |
| ■ Audio head alignment gauge A80/A800/A820 1"  | 10.010.001.04 |
| ■ Audio head alignment gauge A80/A800/A820 2"  | 10.010.001.05 |
| ■ Reference block A80/A800/A820                | 10.010.001.01 |
| ■ Extender board                               | 1.820.799.00  |
| ■ Grease pen                                   | 10.416.001.01 |

#### 3.1.1 Power Supply

##### Checking the supply voltages:

|   |   |
|---|---|
| ■ Lift up the tape transport  |   |
| ■ The FUSE/SUPPLY FAILURE DETECTOR BOARD 1.820.866.00 is equipped with all necessary Test points (see drawing next page). |   |
| <b>TP12:</b> +2V ±20mV  | adjustable with R47 on the FUSE/SUPPLY FAILURE DETECTOR   |
| <b>TP11:</b> +5.6V ±0.1V  | adjustable with R27 on the SWITCHING STABILIZER 1.820.872.00 or with R66 on the board 1.820.872.81/.82                                      |
| <b>TP10:</b> +24V ±1V   | adjustable with R55 on the SWITCHING STABILIZER 1.820.872.00 or with R20 on the board 1.820.872.81/.82                                      |
| <b>TP9:</b> +15V ±0.1V  | adjustable with R15 on the SWITCHING STABILIZER 1.820.871.00, with R35 on the board 1.820.871.81 and with R33 on the board 1.820.873.00/.81 |
| <b>TP8:</b> –15V ±0.1V  |   |
| <b>TP7:</b> +27V  | not adjustable  |
| <b>TP6:</b> –27V  |   |
| <b>TP5:</b> +STABIN 1   | unstabilized voltage between 30V..63V   |
| <b>TP4:</b> +5.2V   | not adjustable  |
| <b>TP3:</b> GROUND  |   |
| <b>TP2:</b> +STABIN 2   | unstabilized voltage between 30V..63V   |
| <b>TP1:</b> +STABIN 3   | unstabilized voltage between 30V..63V   |

##### Reference points:

TP4 and TP12 are reference voltages which are stabilized on the FUSE/SUPPLY FAILURE DETECTOR BOARD itself. This voltages must be checked after repairs have been made on the board.

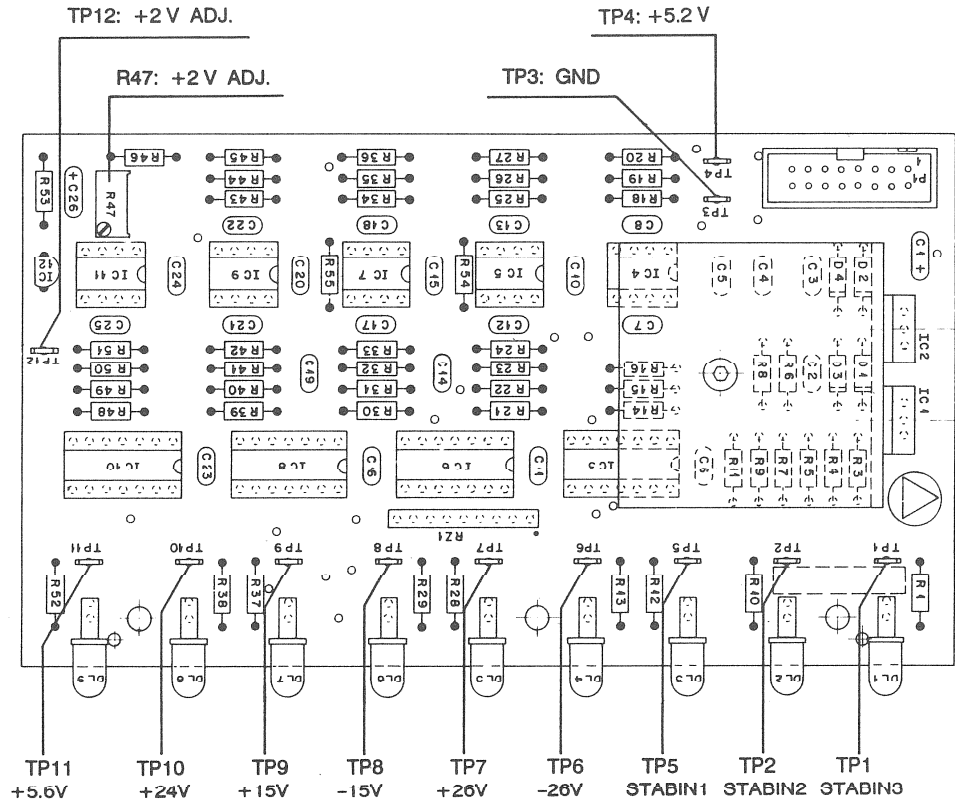

Fig. 3.1.1-1 (Fuse/supply Failure Detector 1.820.866)

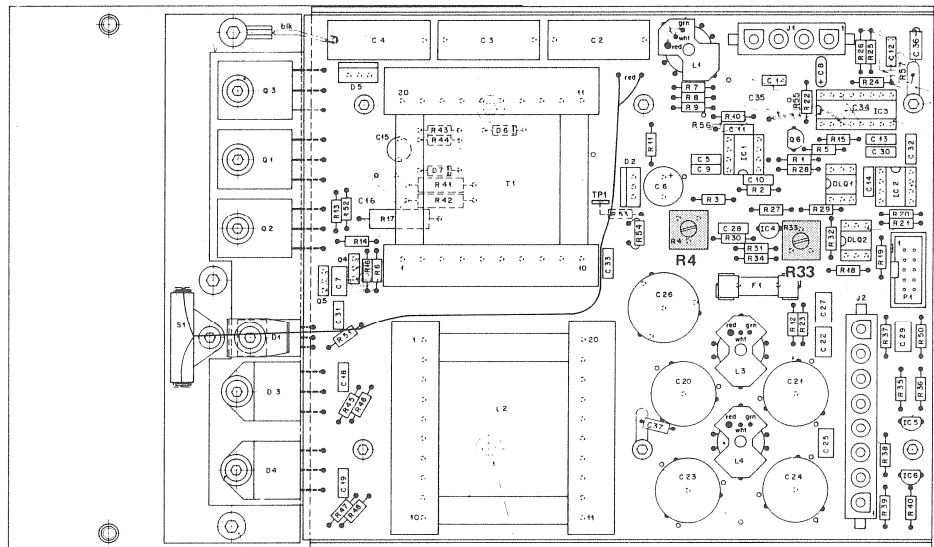

Fig. 3.1.1-2 (SWITCHING STABILIZER  $\pm 15$  V 1.820.873.81)

R33:  $\pm 15$  V adjustment  
 R4: Current limit (factory adjusted)

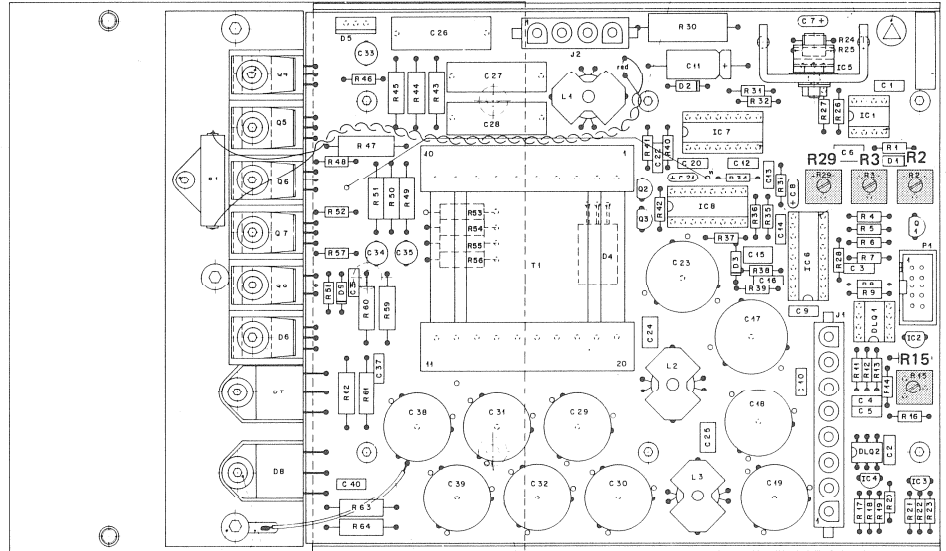

Fig. 3.1.1.-3 (Switching Stabilizer  $\pm 15$  V 1.820.871.00)

- R2: Working point adjustment of the Opto-Isolators DLQ1/2 (factory adjusted).
- R3: Lower input voltage limit (factory adjusted).
- R15:  $\pm 15$  V adjustment.
- R29: Current limit (factory adjusted).

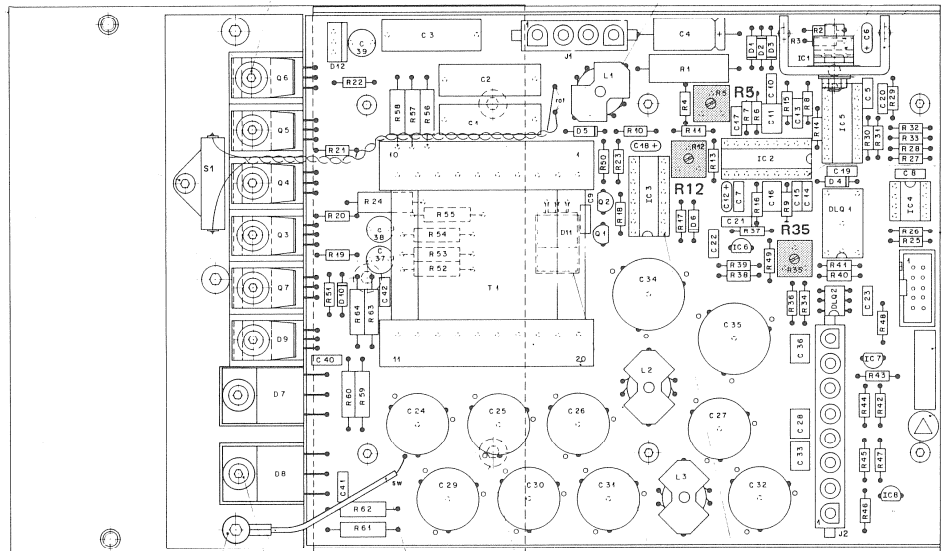

Fig. 3.1.1-4 (Switching Stabilizer  $\pm 15$  V 1.820.871.81)

- R5: Lower input voltage limit (factory adjusted).
- R12: Current limit (factory adjusted).
- R35:  $\pm 15$  V adjustment.

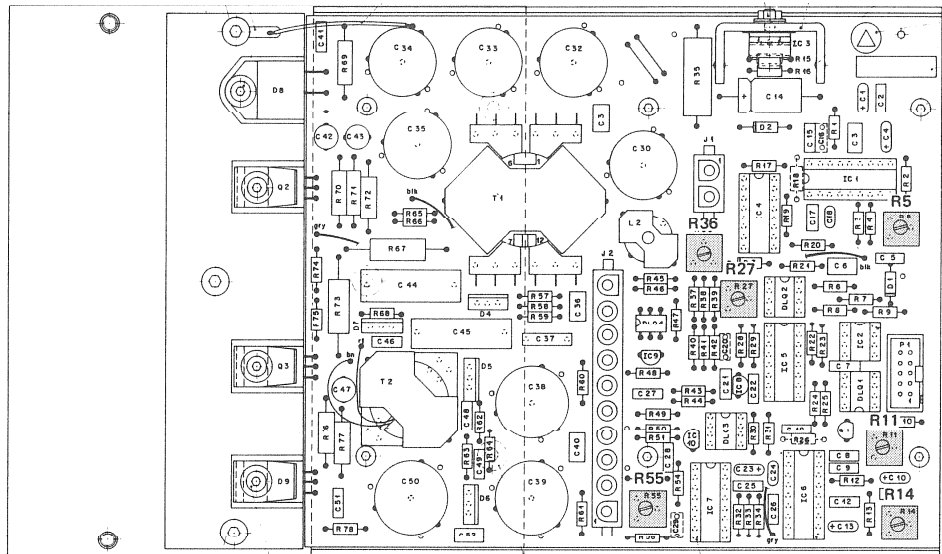

Fig. 3.1.1-5 (Switching Stabilizer + 5 V/AUX 1.820.872.00)

- R5: Lower input voltage limit (factory adjusted).
- R11: Working point adjustment of opto isolator DLQ1 (factory adjusted)
- R14: Current limit for + 24 V (factory adjusted)
- R27: + 5.6 V adjustment
- R36: Current limit for + 5.6 V (factory adjusted).
- R55: + 24 V adjustment

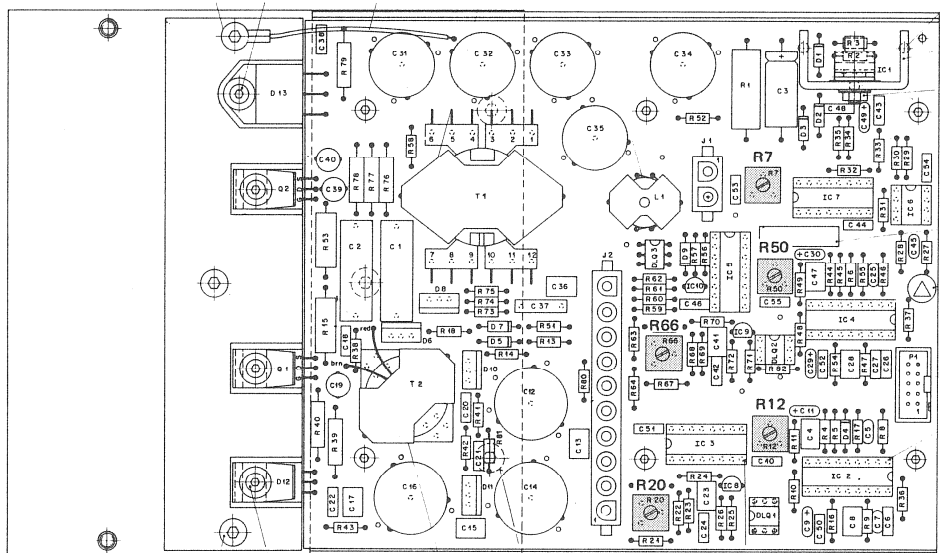

Fig. 3.1.1-6 (Switching Stabilizer + 5 V/AUX 1.820.872.81)

- R7: Lower input voltage limit (factory adjusted)
- R12: Current limit for + 24 V (factory adjusted)
- R20: + 24 V adjustment
- R50: Current limit for + 5.6 V (factory adjusted)
- R66: + 5.6 V adjustment

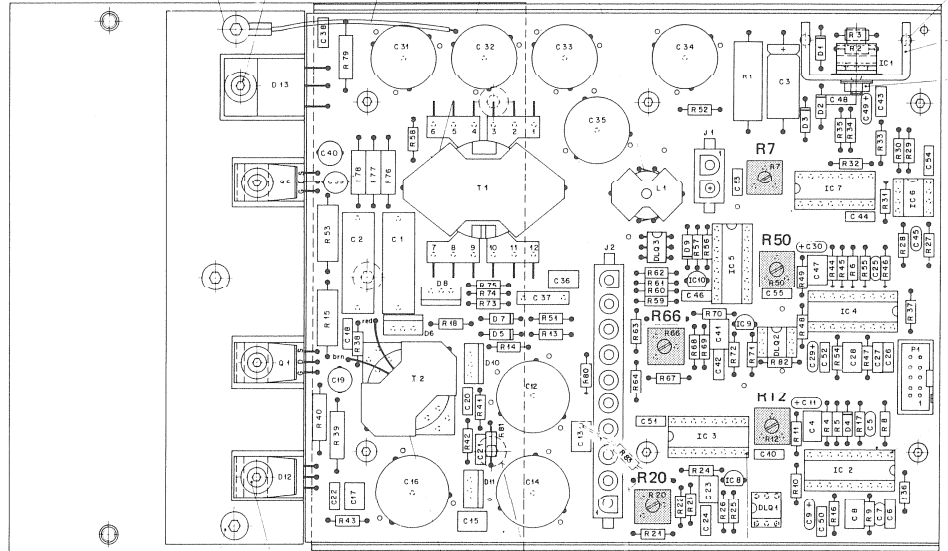

Fig. 3.1.1-7 (Switching Stabilizer + 5 V/AUX 1.820.872.82)

- R7: Lower input voltage limit (factory adjusted)
- R12: Current limit for + 24 V (factory adjusted)
- R20: + 24 V adjustment
- R50: Current limit for + 5.6 V (factory adjusted)
- R66: + 5.6 V adjustment



3.1.2 Opto Sensor (light gate) 1.820.793 GRP44

Preparatory steps:

- Remove the cover behind the headblock and the headblock itself.
- Remove the front section of the upper tape transport cover.
- Then reinstall the headblock and the guide rollers.
- Connect the oscilloscope to test point TP1 and to ground (TP3).
- Switch on the recorder and locate two layers of yellow leader tape with one layer of splicing tape or a longplay tape across the opto sensor.

Alignment:

- Adjust the sine-wave signal on TP1 for maximum amplitude with R6.
- When the trimmer potentiometer R22 is turned from left to right, the voltage increases rapidly up to a certain level, but then changes only marginally. Adjust R22 to that point of change. (Bias of the detector transistor QP1)

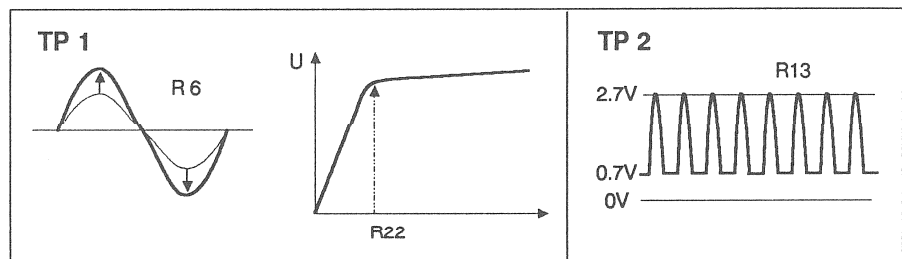

- Connect the oscilloscope to TP2. Adjust the half-waves on the screen to maximum amplitude (ca.2,7V) with R13.

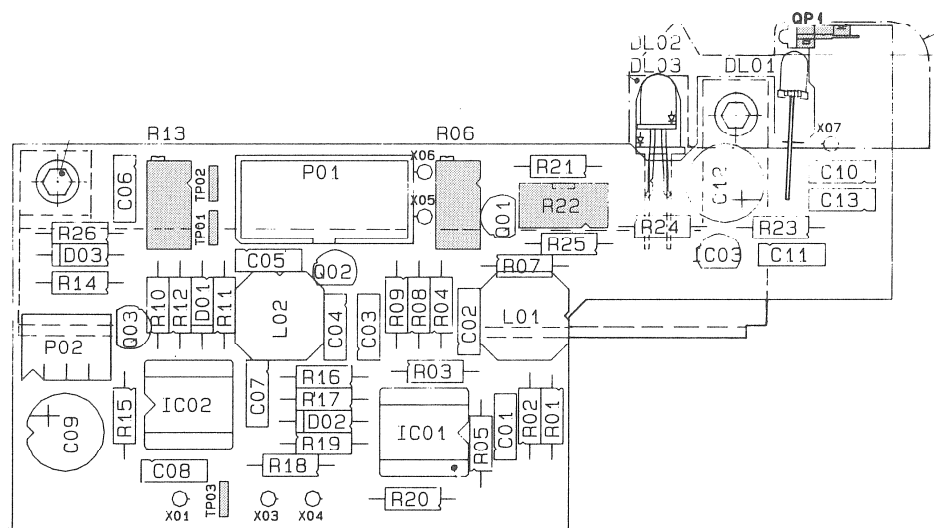

Fig. 3.1.2

- TP1
- TP2
- TP3: GND
- R6
- R22
- QP1
- R13

3.1.3 Move Sensor (tape move sensor) 1.820.770 GRP45

- Switch recorder off.
- Remove TAPE DECK COUNTER/TIMER 1.820.823 and reinsert it via the extender board (1.820.799.00).
- Switch recorder on.
- Connect oscilloscope to terminal 7 and 8 (ground to terminal 21) of the extender board.
- Select highest tape speed and start the tape.
- The duty cycle of the two square-wave signals must be 50% ±10%.
- Adjust with R3 and R9

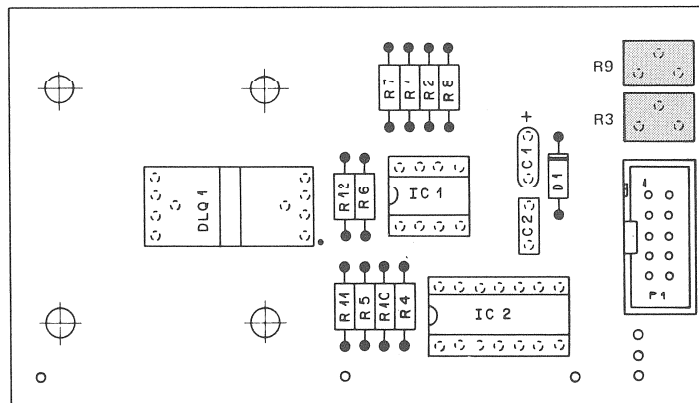

Fig. 3.1.3-1

**Important:**

- The phase shift of 90° between the two square-wave signals cannot be adjusted.

| Signalname | Clockwiserotatation | Counterclockwise rotation | TD Counter/Timer on the Extender Board |
|------------|---------------------|---------------------------|--|
| TD-Move 1  |                     |                           | Pin 7<br>(GND: Pin 21)                 |
| TD-Move 2  |                     |                           | Pin 8<br>(GND: Pin 21)                 |

Fig. 3.1.3-2

3.1.4 Mechanical Brakes GRP40 (left), GRP41 (right)

Checking the brake:

- Switch the recorder off.
- The correct function of the brakes can be checked briefly by turning the adapter forward and backward. Whenever the direction changes, one of the two brake levers audibly contacts the lifting pin or the stop pin.

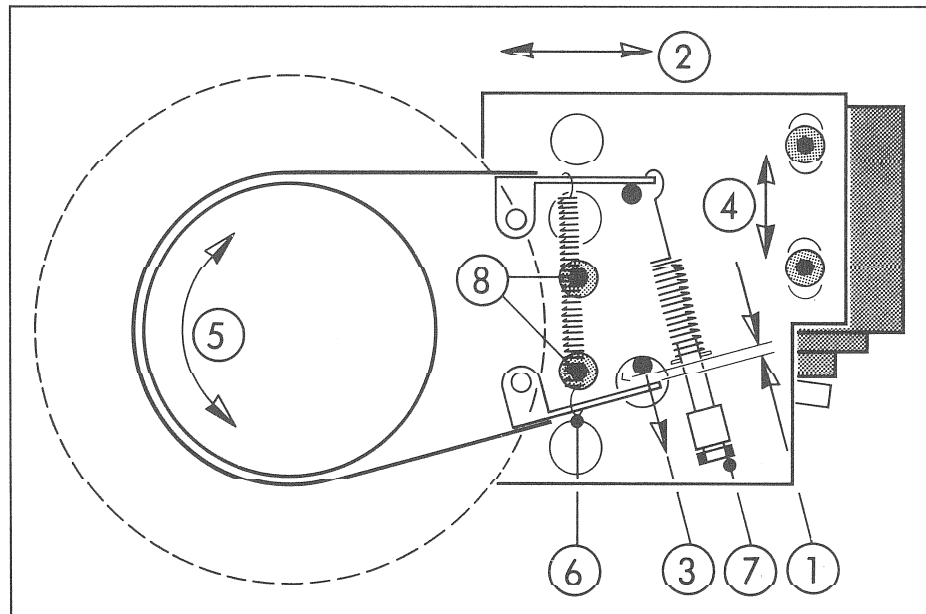

Fig. 3.1.4-1

Adjusting the brake assembly:

- Switch recorder off.
- Remove rear section of upper tape transport cover.
- The play [1] between the brake lever and its lifting pin must be 1 to 1.5 mm.  
Adjustment procedure:
  - Unfasten the two mounting screws [8] of the brake assembly (Allen screwdriver No. 3).
  - Shift brake assembly sideways (keeping it parallel) until the required play is attained. Retighten the mounting screws.
- The travel [3] of the lifting pin should be 4 to 5 mm. Check by pressing against the armature of the brake solenoid. The travel can be adjusted by shifting the brake solenoid after the two mounting screws of the brake assembly [4] (Allen screwdriver No. 3) have been loosened.
- Retighten the fixing screws.

Adjusting the retarding torque:

- Retarding torque in take-up direction (weak braking):  
torque:
  - Load an empty reel with 2 to 3 m of tape in direction opposite the normal operating position.
  - Hook spring dynamometer 0 – 5 N (0 to 500 p) into a loop at the start of the tape; unwind tape slowly and evenly. The retarding torque can be adjusted to the value specified in the following table by rehooking the spring [6].
- Retarding torque in supply direction (strong braking):
  - Load an empty reel with 2 to 3 m of tape in normal operating position.
  - Hook spring dynamometer 0 – 25 N (0 to 2.5 kp) into a loop at the start of the tape; unwind tape slowly and evenly. The retarding torque can be adjusted by means of screw (7) to the value specified in the table below.

- Replace the brake drum and brake band if the necessary retarding force can't be achieved. Another possibility might be to clean the surface of the brake band with acetone.

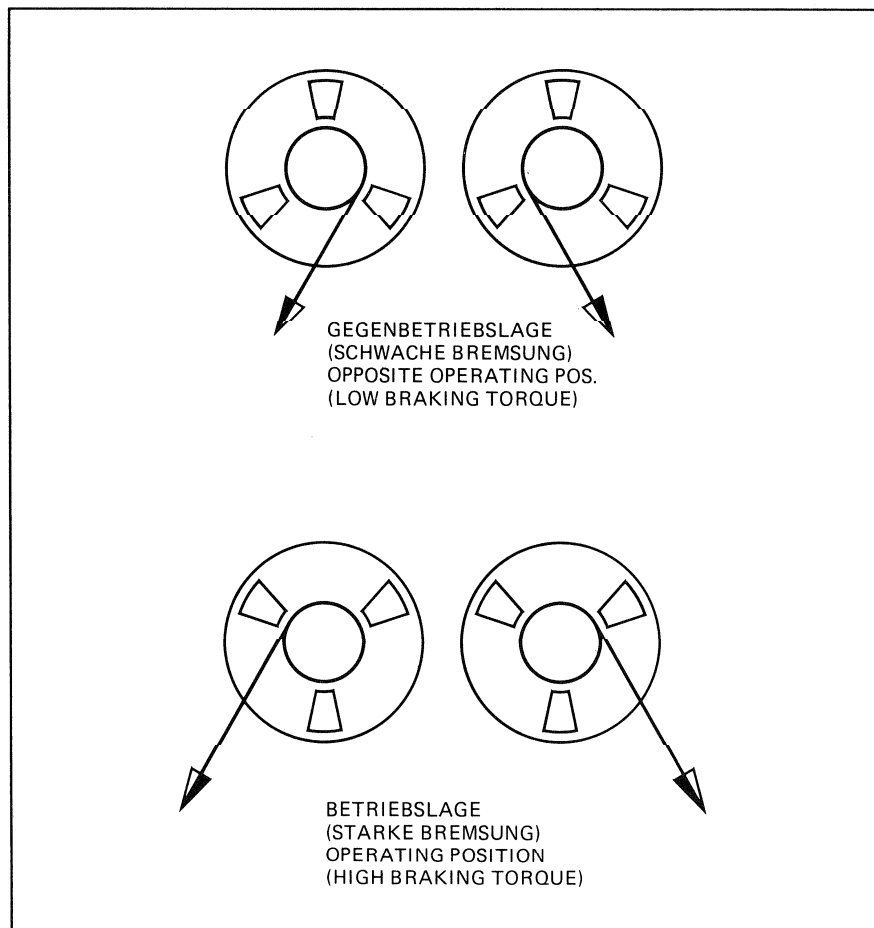

Fig. 3.1.4-2

|    | Left-hand reel                          |                                       | Right-hand reel                         |                                       |
|----|---|---------------------------------------|---|---------------------------------------|
|    | Take-up direction (opposite oper. pos.) | Supply direction (operating position) | Take-up direction (opposite oper. pos.) | Supply direction (operating position) |
| 1" | < 1.5 N (< 150 p)                       | 8 N ± 0.5 N (800 p ± 50 p)            | < 1.5 N (< 150 p)                       | 8 N ± 0.5 N (800 p ± 50 p)            |
| 2" | < 1.5 N (< 150 p)                       | 8 N ± 0.5 N (800 p ± 50 p)            | < 1.5 N (< 150 p)                       | 8 N ± 0.5 N (800 p ± 50 p)            |

### 3.1.5 Tape Tension Sensor 2" and 1"

Tape Tension Sensor 2"  
Tape Tension Sensor 1"

1.820.387 GRP42 (left), 1.820.388 GRP43 (right)  
1.820.385 GRP42 (left), 1.820.386 GRP43 (right)

#### Step 1

Electrical adjustment of the tape tension sensor PCB:

- Remove rollers and use gauge as shown in Fig. 3.1.5-1 and Fig. 3.1.5-2.
- Connect digital voltmeter to the test points TP1 and TP2 (ground).
- Adjust with R7 (Offset-adjust) to a voltage of  $0,4V \pm 20mV$  (see Fig. 3.1.5-3).
- Adjust with R9 (Gain-adjust) to a voltage of  $2,4V \pm 50mV$  (see Fig. 3.1.5-3).

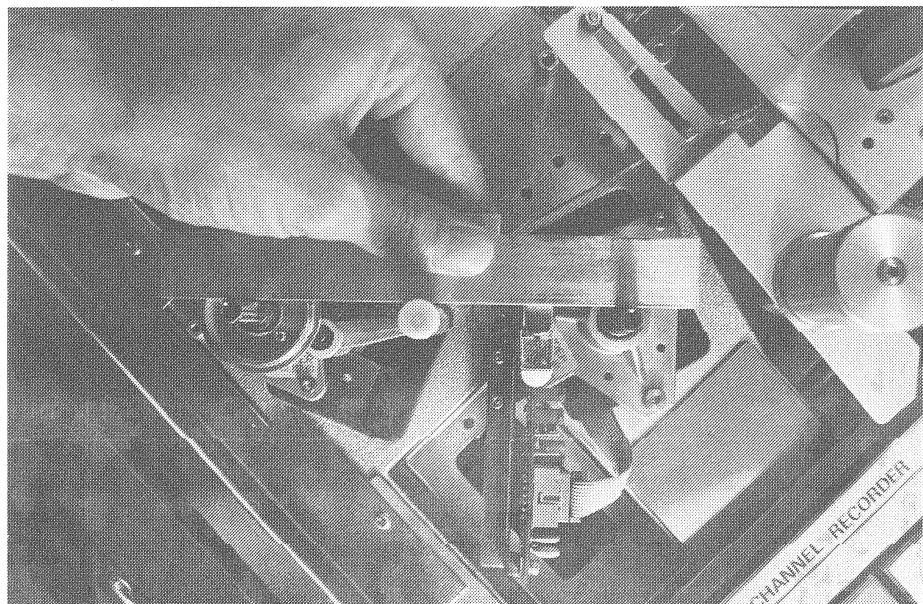

Fig. 3.1.5-1

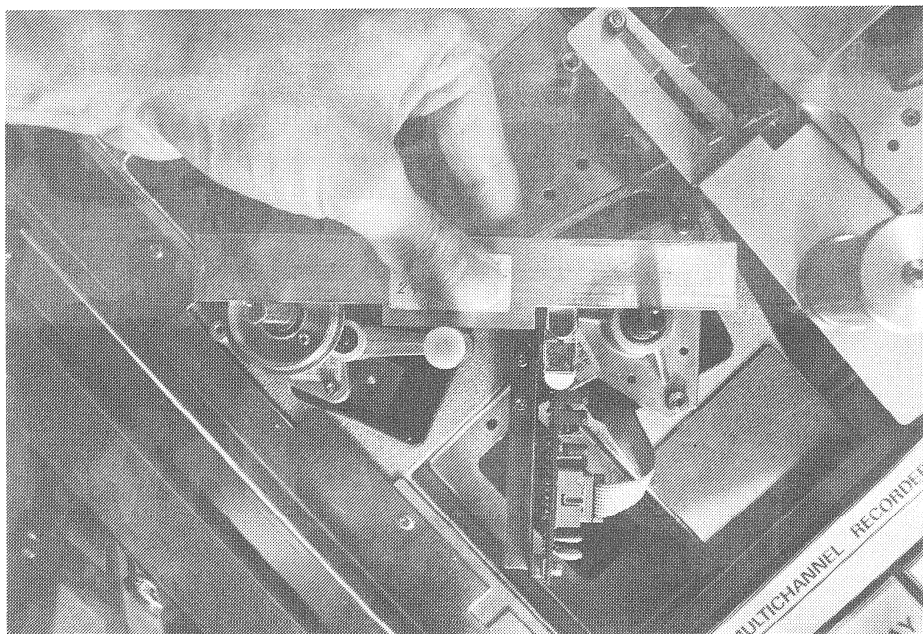
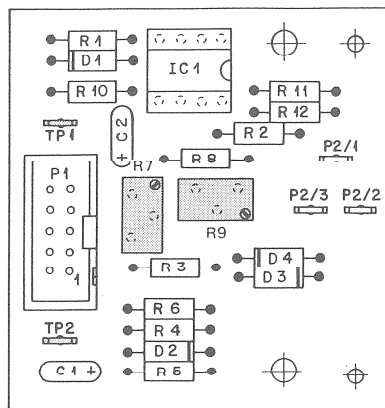

Fig. 3.1.5-2



TP1  
 TP2: GND  
 R7  
 R9

Fig. 3.1.5-3

**Step 2**

Adjusting the tape tension spring:

The offset and the gain must be checked and aligned, if necessary, before this adjustment can be carried out (Step 1).

- Hook on the large weight 520g for 2"/325g for 1" → voltage  $V_1$ . (see Fig. 3.1.5-4).
- Hook on the small weight 120g for 2"/75g for 1" → voltage  $V_2$ . (see Fig. 3.1.5-4).

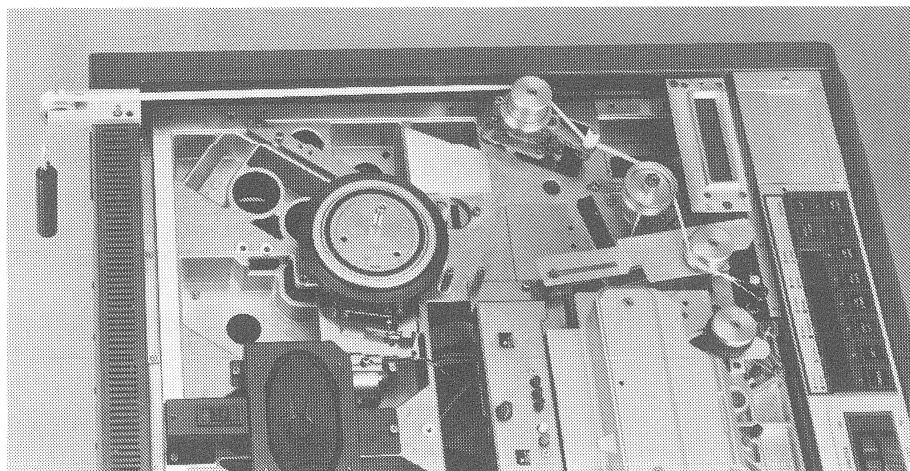

Fig. 3.1.5-4

$$V_1 - V_2 = \Delta V$$

$$2,2V - 0,2V = 2V$$

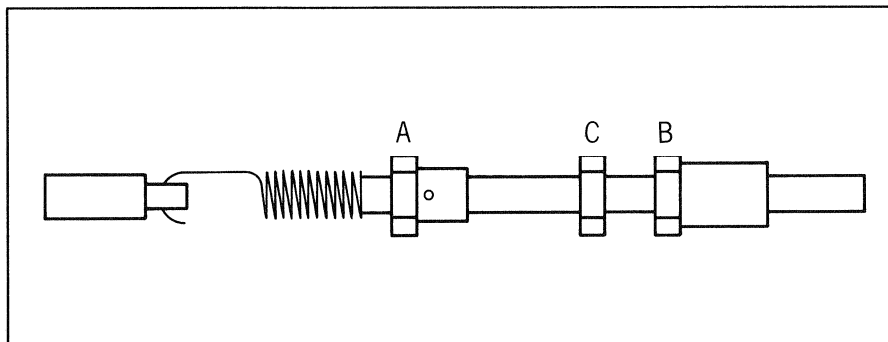

Fig. 3.1.5-5

- Turn nut [A] to adjust the length of the spring until you get  $\Delta V = 2V$ . (see Fig. 3.1.5-5). ( $V_1$  and  $V_2$  for the moment not important!)
- Loosen locknut [B].
- Adjust the required voltages of  $2,2V \pm 50mV$  for the large weight by turning in or out the threaded shaft [C]. The  $0,2V \pm 30mV$  should be attained automatically if  $\Delta V=2V$  has been adjusted correctly. (The procedure can be done vice versa to!)
- Tighten the locknut [B], the voltages must remain between the limits.

### 3.1.6 Pinch Roller Assembly

**Adjustments:**

Adjusting the distance between pinchroller shaft and headblock plate:

- Switch tape recorder off.
- Remove pinch roller.
- Insert allen screwdriver No. 3 into the hole [1] and turn the pinch roller assembly clockwise to the end stop (Play-Position), see Fig. 3.1.6-1.
- Lift recorder to service position and adjust from below through an opening in the cast chassis.
- Loosen locknut (opening between flats 7 mm) [2] see Fig. 3.1.6-2 on the tie rod at the pinch roller assembly and turn tie rod [3] until a distance of approx. 0.1 mm between pinchroller shaft and headblock plate is attained.
- Retighten locknut and secure with locking paint.
- Install pinch roller.

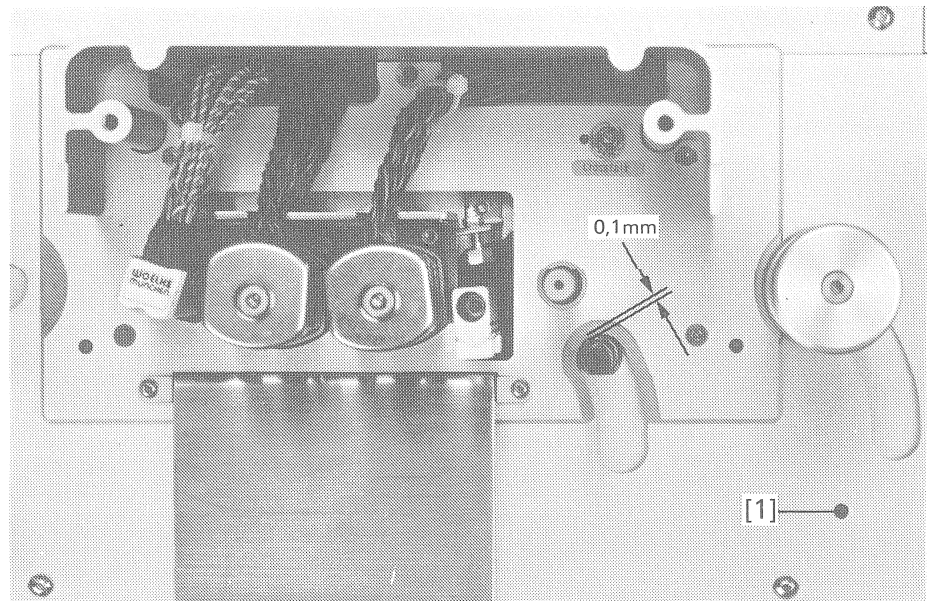

Fig. 3.1.6-1

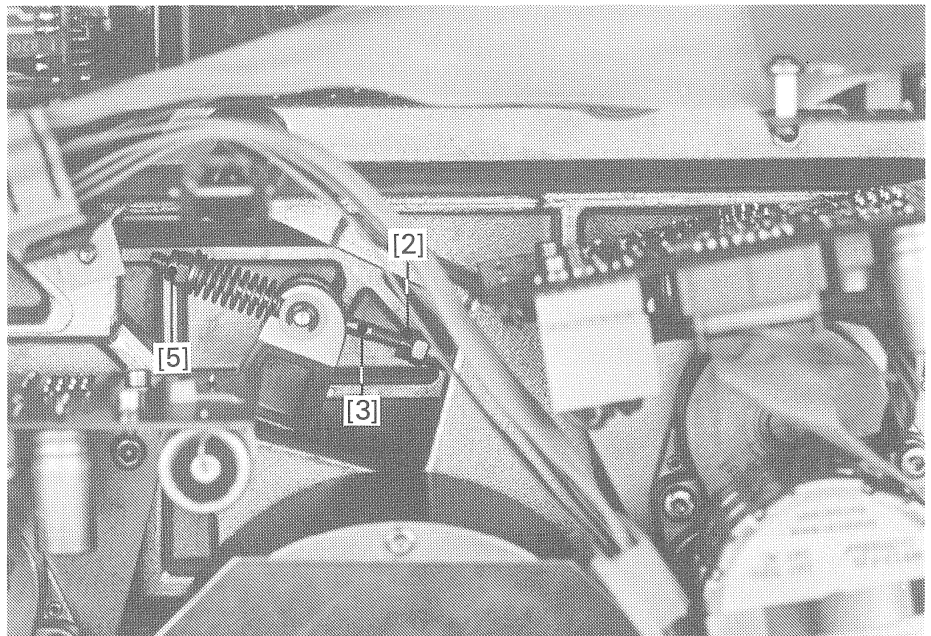

Fig. 3.1.6-2

#### Checking the pinching force:

- Unscrew fixing screw [4] from the pinch roller cover and turn it into the tapped hole of the pinch roller shaft by 3 to 4 turns.
- Load a tape, switch recorder on, select PLAY mode.
- Hook spring dynamometer 0-20 N to the screw [4], and pull in the direction of the connecting line between the centers of the capstan shaft and the pinch roller (see Fig. 3.1.6-3).  
While pulling, lightly brake the pinch roller with your finger.
- The spring dynamometer should indicate  $12\text{N} \pm 1\text{N}$  ( $1.2\text{kp} \pm 0.1\text{kp}$ ) at the point where the pinch roller just lifts off the tape and consequently stops.



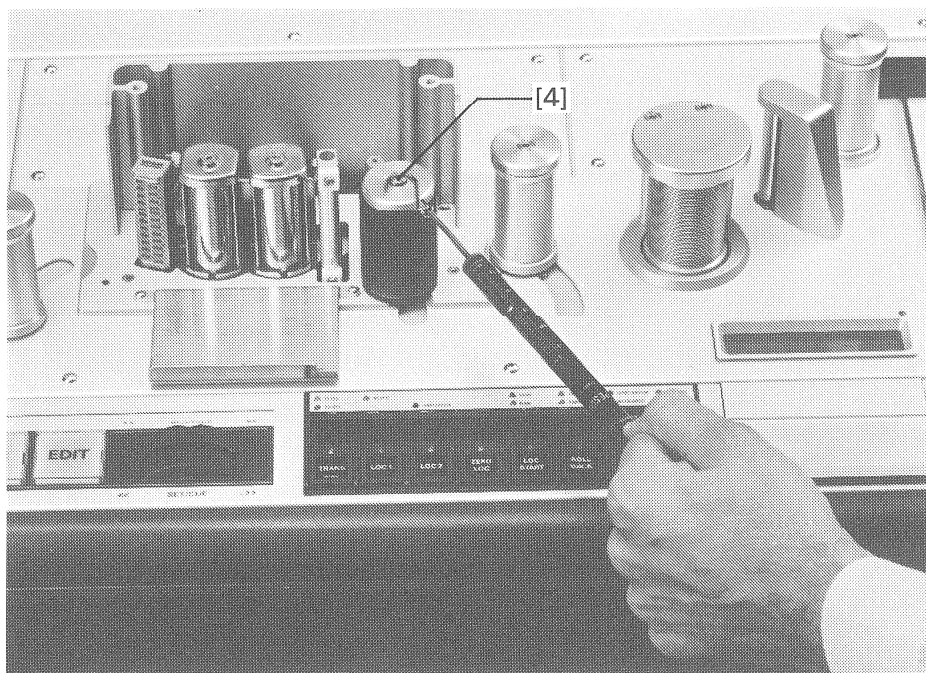

Fig. 3.1.6-3

#### Adjusting the pinching force:

If this value is not attained, the pinch roller spring has to be readjusted.

- Lift recorder to service position.
- The adjusting nut [5] (prevailing torque type nut, opening across flats 7 mm) of the pinch roller assembly is accessible through an opening in the cast chassis. Adjust until the requested value is attained (see Fig. 3.1.6-2).
- Reinstall pinch roller cover after the adjustment.

### 3.1.7 Lifter Pin

#### Lifter pin ELM 10

Adjustment of the wrap at the tape lifter pin ELM 10

1. Remove the headblock cover.
2. Unfasten the locknut, key width 5.5mm (Z).
3. Insert the tape and start the machine in play mode.
4. Turn the stop screw, key width 7mm (Y) clockwise until a small air gap becomes visible between the lifter pin and the tape.
5. Slowly turn the stop screw (Y) counterclockwise until the air gap between the lifter pin and the tape disappears. Mark the setting of the stop screw (Y) with a paint dot.
6. Turn the stop screw (Y) clockwise by one full turn and hold it in this position with an open-end wrench. Tighten the locknut (Z) with a second open-end wrench.
7. After this adjustment the wrap is now 2°.
8. After the adjustment of the lifter pin, the wrap around the record and reproduce head has to be checked (s. section 3.1.9).

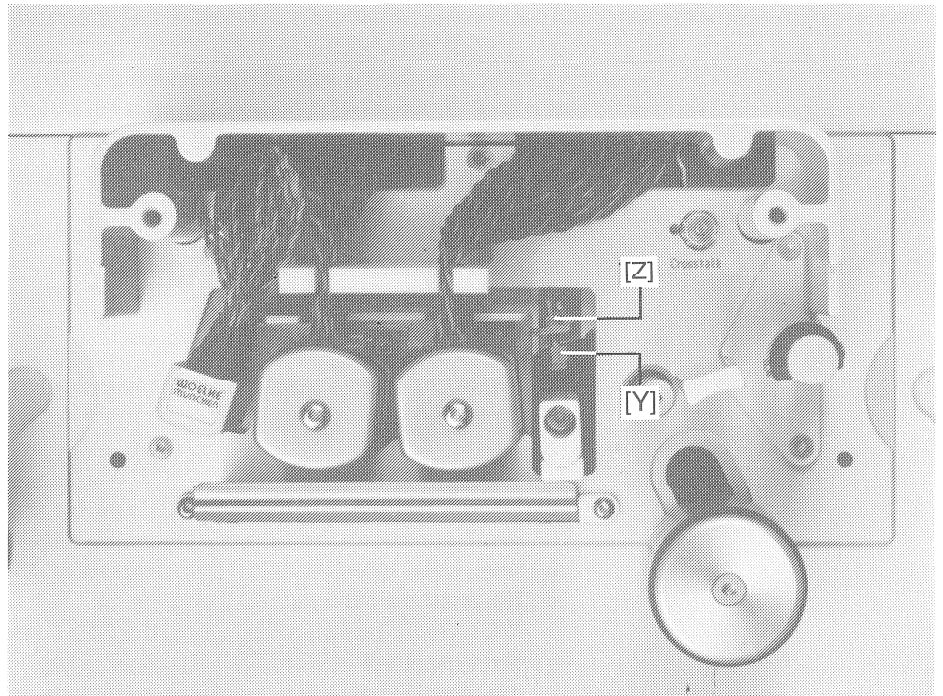

Fig. 3.1.30-13

After the tape transport elements have been adjusted, check the tape movement according to Section 3.1.15.

### 3.1.8 Tape Tension

#### Check measurements:

The tape tensions are measured with a Tentelometer (Order No. 10.300.001.02). The Tentelometer should be calibrated with the 2oz weight and with the same brand of tape used afterwards for the tape tension adjustment. The tape should run perpendicularly over the center of the Tentelometer. Depending on the Tentelometer you use, you may have to remove the front section of the upper tape transport cover in order to gain unobstructed access to the tape.

- Switch tape recorder on, select tape speed 15 ips as well as the corresponding tape type (the tape tension values change over depending on the setting TAPE A/B).
- Load a tape and wind forward until the tape pancakes are the same size on both reels.
- PLAY and REVERSE PLAY tape tension:  
The values specified in the table below must be attained. When the pinch roller is manually lifted slightly off the tape, the reels should stand still after one full revolution at the most. The service display should indicate the following message:

ERR: PINCH ROLLER  
SLIPPING

(After having released the pinch roller, this message disappears).

## Tape tension adjustments:

These values must be corrected if they are not attained.

- Unlock the PROGRAM ENABLE key by using an allen screwdriver No. 2,5 (the hole on left side of the service display).
- "SET PLAY TENSION" by using the NEXT key (see menu chart).
- Start machine in PLAY and check or adjust, if necessary, the PLAY-tape tension to the specified value (see corresponding list).
- Press STORE.
- "SET REV PLAY TENSION" by using the NEXT key (see menu chart).
- Start machine in REVERSE PLAY, with TRANS and PLAY and check or adjust, if necessary, the REVERSE PLAY-tape tension to the specified value (see corresponding list).
- Press STORE.
- Press LAST ten times to go back to the operating display.
- If nothing else has to be resetted in the menu, lock the PROGRAM ENABLE key.

## Wind tape tensions:

- Unlock the PROGRAM ENABLE key by using an allen screwdriver No. 2,5 (the hole on the left side of the service display).
- "SET MAX. WIND SPEED" by using the NEXT key (see menu chart).
- Set a value to 0.5 m/s by using the SET-wheel.
- "SET WIND TENSION" by using the NEXT key (see menu chart).
- Start machine in wind and check or adjust, if necessary, the wind tension to the specific value (see corresponding list).
- Press STORE.
- Press LAST four times to go back to the "SET MAX. WIND SPEED".
- Set the max. speed back to 15m/s.
- Press STORE.

## STOP and EDIT tape tension:

- Switch tape recorder to EDIT.

If nothing else has to be programmed in the menu, lock the PROGRAM ENABLE key.

|              | 2" TAPE TENSIONS                       |                 | 1" TAPE TENSIONS                       |                 | 1" TAPE TENSIONS<br>(Conversion kit from 2") |                 |
|--------------|--|-----------------|--|-----------------|--|-----------------|
|              | Tentelometer between<br>Left reel<br>L | Right reel<br>R | Tentelometer between<br>Left reel<br>L | Right reel<br>R | Tentelometer between<br>Left reel<br>L       | Right reel<br>R |
| PLAY         | 380p ± 10p                             | 450p ± 10p      | 200p ± 10p                             | 240p ± 10p      | 300p ± 10p                                   | 350p ± 10p      |
| REV.<br>PLAY | 450p ± 10p                             | 380p ± 10p      | 240p ± 10p                             | 200p ± 10p      | 350p ± 10p                                   | 300p ± 10p      |
| WIND         | 400p ± 10p                             |                 | 210p ± 10p                             |                 | 300p ± 10p                                   |                 |
| STOP<br>EDIT | 350p ± 10p                             |                 | 200p ± 10p                             |                 | 350p ± 10p                                   |                 |

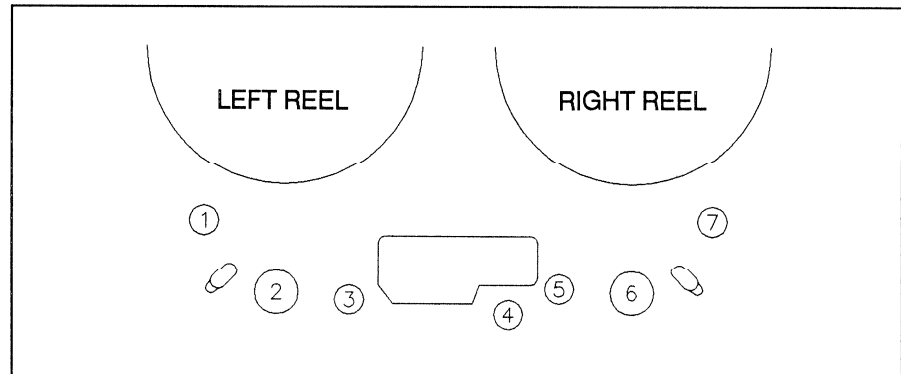

Fig. 3.1.8

**Set "MAX. WIND SPEED"**

Recommended Max. Wind Speed for:

|               |            |
|---------------|------------|
| Agfa 468      | max. 10m/s |
| Agfa 469      | max. 10m/s |
| BASF SPR 50LH | max. 10m/s |
| BASF 911      | max. 15m/s |
| Ampex 456     | max. 15m/s |
| Scotch 226    | max. 15m/s |
| Scotch 250    | max. 15m/s |

**3.1.9 Exchanging and Adjusting the Heads**

**Important:** To prevent unwanted magnetization of the heads, the recorder must be switched off before the headblock is removed or reinstalled.

Exchanging the heads:

- Remove pinch roller (1 screw, allen screwdriver No. 3).
- Remove cover behind headblock (4 screws, allen screwdriver No. 2.5).
- Remove headblock (5 screws, allen screwdriver No. 3).
- Remove head block cover (2 screws, allen screwdriver No. 3).
- Remove the rear cover profile (2 screws [L], allen screwdriver No. 3) (see Fig. 3.1.9-1).
- Loosen the allen screw [A] for the REPRO-head, [B] for the RECORD-head or [C] for the ERASE-head (allen screwdriver No. 3).
- Remove one, two or three connector(s), depending on the head (8/16 or 24 track). The ground links for the REPRO-head have to be disconnected from the headblock chassis and from the mounting bracket.
  - Mark the position of the connectors in case of a 16 track or 24 track headblock.
- Reassemble the headblock in the same sequence.

**Important:** The black swivel plate must not be shifted when exchanging a head. The distance between the head support and the face of the head has been milled to the same dimensions for all heads which means that no adjustments are necessary.

- After the heads have been exchanged, the perpendicularity of the head can be checked by means of the head alignment gauge A80/A800 1" (Order No. 10.010.001.04) or the head alignment gauge A80/A800 2" (Order No. 10.010.001.05), resp., on the reference block A80/A800/A820 (Order No. 10.010.001.01). The headshield flap must be removed for this check (2 screws, allen screwdriver No. 2). The headblock and the gauges should be set on a levelling plate (or by way of expedient on a flat glass plate).
- When reinstalling the headblock, be careful to insert the connectors correctly before tightening the screws.

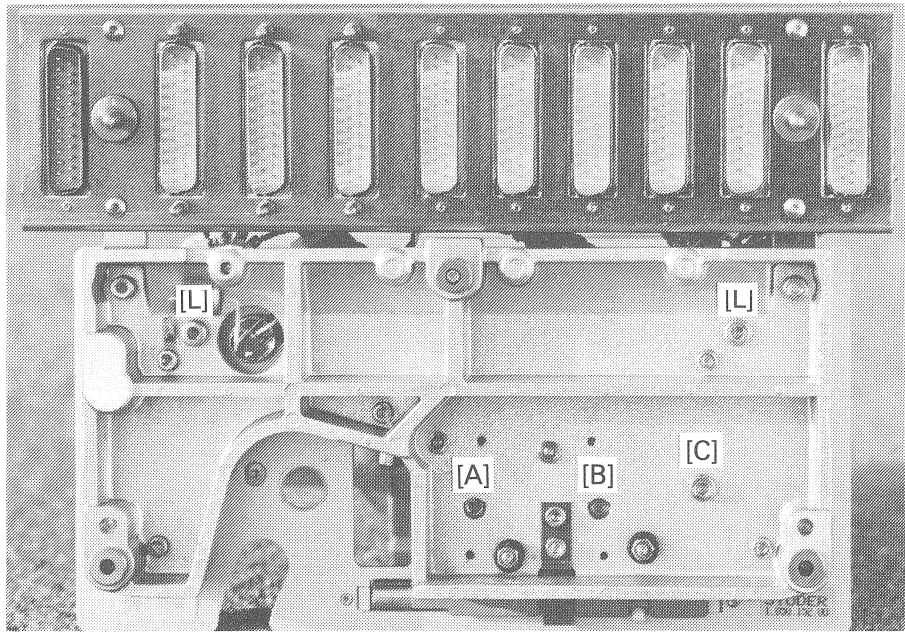

Fig. 3.1.9-1

Aligning the face of the record and the reproduce head

Prerequisite:

Tape tension adjusted according to 3.1.8.

- Mark the face of the record and the reproduce head with a grease pen (Order No. 10.416.001.01).
- Load a used tape, select 15 ips tape speed, and allow the recorder to run in PLAY mode for approximately three minutes.
- Stop recorder and lift the tape carefully off the head. The head face is aligned correctly if the colour has been polished off symmetrically on both sides of the headgap (if necessary check with magnifying glasses). Should this not be the case, the head must be brought into the correct position by turning it; recheck head gap position afterwards, as described above.

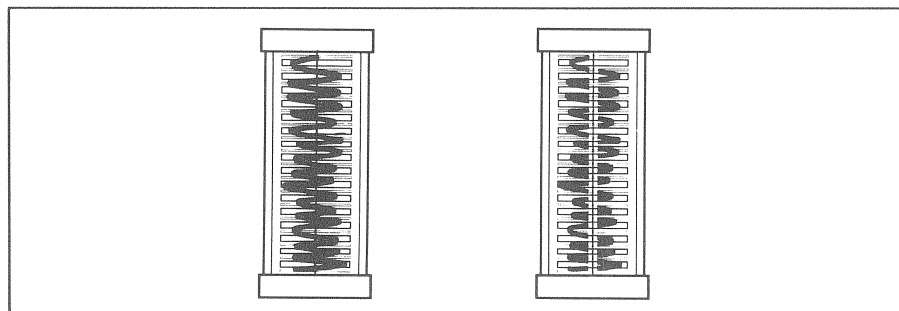

Fig. 3.1.9-2

### Aligning the head face of the erase head

- Remove head cover (2 screws, Allen screwdriver No. 3).
- Mount tape and start recorder in PLAY mode.
- Look at the erase head vertically from the top and align the head in such a way that the spacings [a] from the left-hand and the right-hand edge of the head to the tape are identical. (Fig. 3.1.9-3)

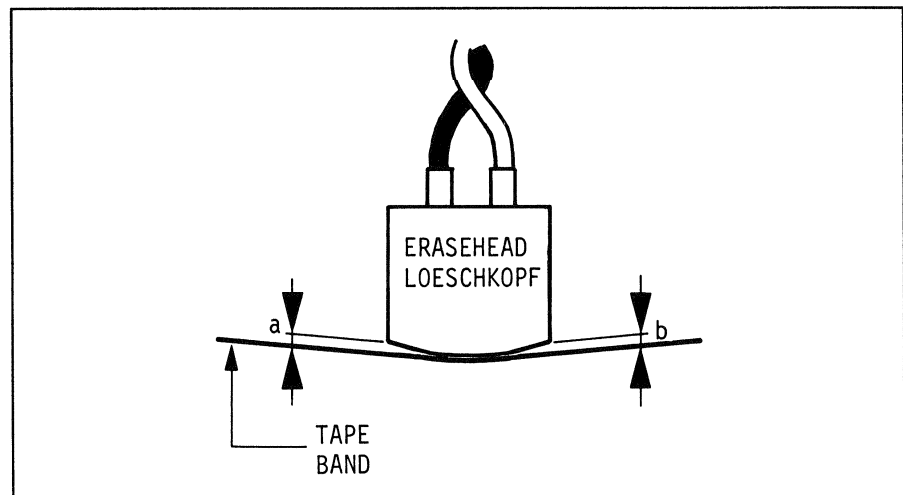

Fig. 3.1.9-3

### 3.1.10 Capstan Motor GRP38

#### Tacho sensor electronics PCB 1.021.695.81

The capacitive-scanner as well as the three Hall-effect sensors are not adjustable.

- Remove the headblock and the front section of the tape transport cover.
- Tilt up the machine to the service position.
- Remove the capstan motor by unfasten the three allen screws (No.3) from the upper chassis side (Caution: Hold the motor from below).
- Remove the tacho sensor electronics PCB by unfasten the two allen screw (No. 2.5).
- Use a board between the two side panels to put on the motor, still connected to the capstan motor driver amplifier.
- Switch recorder on, without tape. Tape speed 15ips.
- Set oscillator frequency with L1 to 5.5 MHz  $\pm$  500 kHz (Fig. 3.1.10).
- Connect oscilloscope (possibly AF voltmeter) to TP 4 (ground lead to TP1).
- Adjust for maximum amplitude with L3.
- Connect oscilloscope (possibly AF voltmeter) to TP 3 (ground lead to TP1).
- Adjust for maximum amplitude with L2.
- Connect oscilloscope to signal TD-TCMI (ICI/Pin 2) and adjust with R41 to a duty cycle of 50%.

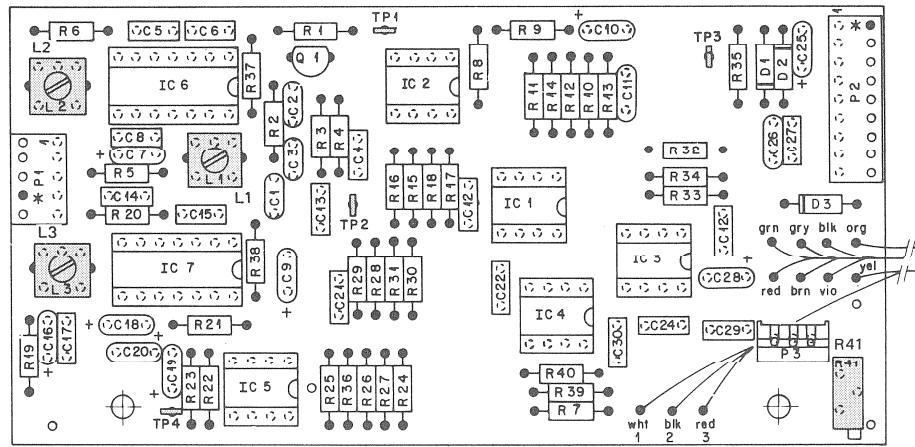

Fig. 3.1.10

### 3.1.11 Spooling Motor Tacho 1.820.771 GRP36 (left), GRP37 (right)

**Adjustments:**

- Plug in the TAPE DECK COUNTER/TIMER PCB 1.820.823 via the extender board (Order No. 1.820.799.00).
- Connect oscilloscope to terminal 1 and 2 (left-hand motor), terminal 3 and 4 (right hand motor), and ground lead to terminal 21 of the extender board.
- Load a tape and switch recorder to wind mode.
- Check symmetry of wave form. The duty cycle of the square wave signals (two for each motor) should be 50% ± 10%.

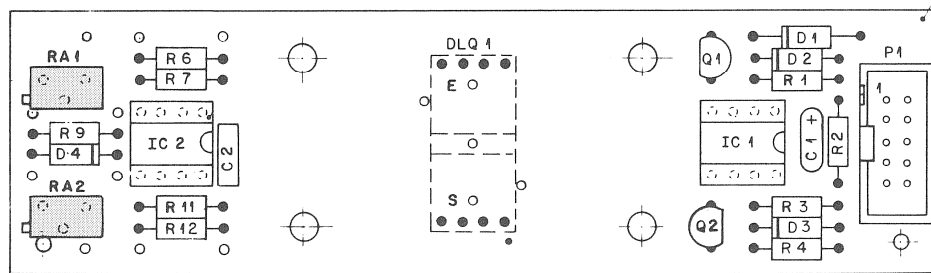

Fig. 3.1.11

**Important:**

- The phase shift of 90° between the two square-wave signals cannot be adjusted.

3.1.12 Cue Sensor (Edit assembly) 1.820.765 GRP49

SET/CUE:

duty cycle adjustment

- Remove:
  - the small cover behind the headblock
  - headblock,
  - front section of the tape transport cover
  - push button rail
  - lower tape transport cover (grey)
- Connect oscilloscope to TP1 or TP2 respectively, ground lead to TP3 of the CUE SENSOR BOARD 1.820.765.
- Switch the machine on.
- Turn the SET/CUE wheel as steadily as possible.
- Check or adjust if necessary to get a 50%/50% duty cycle ( $\pm 10\%$ ) signal. Corrections can be made with R1 (TP1) and R2 (TP2) on the board for the corresponding signal TM-CUF1 and TM-CUF2.

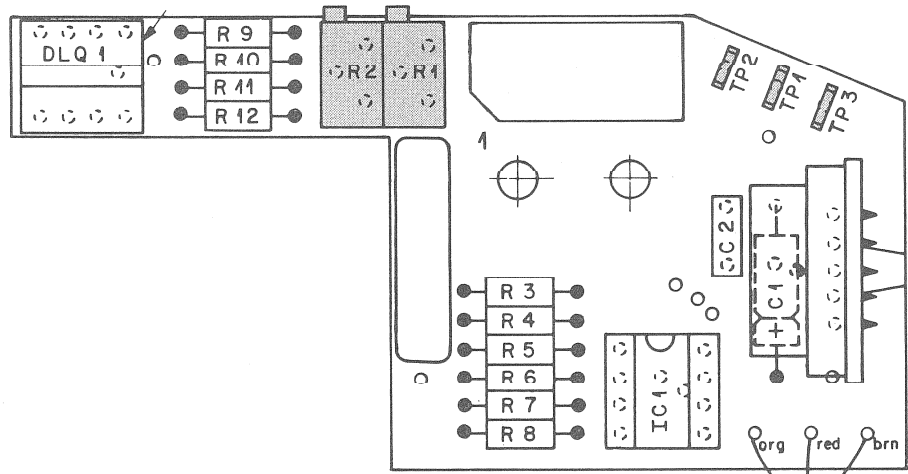

Fig. 3.1.12-1

SHUTTLE:

check the position

Prerequisite: The SHUTTLE wheel returns easily to its center position from both directions.

- Remove:
  - the small cover behind the headblock
  - headblock
  - front section of the tape transport cover
  - push button rail
  - lower tape transport cover (grey)
- Connect a digital voltmeter (range  $10V_{DC}$ ) to the SHUTTLE-potentiometer wires (+  $\hat{=}$  red wire, ground  $\hat{=}$  brown wire).
- Turn SHUTTLE to the far right and write down the measured value (3).
- Turn SHUTTLE to the far left and write down the measured value (1).
- The NEUTRAL POSITION must now be in the middle (2).

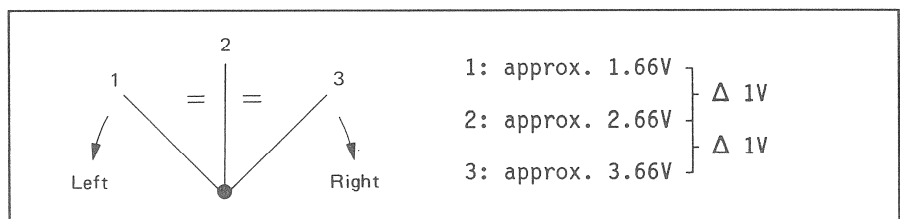

Fig. 3.1.12-2



- adjust the position**
- Remove the pushbutton assembly and flip it down. Be careful that you have no short-circuit and that you don't stretch the flat cable.
  - Remove the SHUTTLE / EDIT-Assembly from the Pushbutton Assembly by loosen the 3 screws (2,5mm allen-screws) and the distance bolt (5,5mm wrench.)
  - Lightly loose the setscrew on the small toothed wheel (on the potentiometer shaft).
  - Hold the SHUTTLE wheel in the center position and turn the potentiometer shaft with the aid of a screwdriver until the correct value is attained.
  - Recheck after the setscrew has been tightened.
  - Reinstall the assembly.

### 3.1.13 LC Display Unit 1.820.233, 1.820.239 GRP52

---

The contrast of the LC display can be optimized.

- Optimize the contrast with the trimmer potentiometer (the potentiometer is accessible from a hole on the top right-hand corner of the LC-display).

### 3.1.14 Adjustments on the Tape Transport Control Boards

---

**Adjust after repair:**

- TAPE DECK SERIAL INTERFACE 1.820.763:  
Adjust on TP2 to +5V
- SPOOLING MOTOR CONTROLLER 1.820.822:  
Adjust on TP2 to  $-5V \pm 10\text{ mV}$  (with R34).
- CAPSTAN INTERFACE 1.820.727:  
Adjust on TP1 to  $+10V \pm 10\text{ mV}$  (with R12).

**Test points:**

- TAPE DECK PERIPHERY CONTROLLER 1.820.762:  
Both test points are used in the factory for board testing.

**Test points:**

- SPOOLING MOTOR DRIVE AMPLIFIER  
TP1 Ground.  
TP2 Voltage proportional to the motor current (Sensitivity: 312,5mV/A).  
TP3 Ground.  
TP4 Pulse-width-modulated (PWM) control signal for motor power stage.

**Test points:**

- CAPSTAN MOTOR DRIVE AMPLIFIER 1.820.774:  
TP1 Ground.  
TP2 Dirac pulse, TTL-Level, 76 kHz.  
TP3 Pulse-width-modulated signal, amplitude 0 to 50V (relative to ground), voltage depends on capstan motor speed, 76 kHz.  
TP4 DC voltage, value between 0 and 40V.  
TP5 } 120° phase-shifted AC voltages  
TP6 } Waveform,  6,5V to 40V.  
TP7 }  
TP8 Square-wave signal, TTL-level, output signals of the three Hall-effect sensors (triple frequency).

### 3.1.15 Removing the Modules

**Warning:** Unplug the power cord before removing any modules!

- Unfasten the allen screw No. 3, in the center of the linged cover below the tape transport. The cover can now be opened to pull out the different boards.
- Each audio-rack includes two amplifier sections. The amplifiers of each section are held back with a rail. To remove a board unfasten the three allen screws no. 2,5.

### 3.1.16 Headblock

#### Headblock cover

- Unfasten the two allen screws no.3 [A] to remove the cover.
- Unfasten four screws [C] (allen screwdriver no. 2,5), remove the cover.

#### Headblock

- To prevent magnetization of the heads, the tape recorder must be switched off when removing or installing the headblock.
- Remove the cover behind the headblock by unfasten the four allen screws no. 2,5 [B].
- Unfasten the three recessed screws no. 3 [C]
- Unfasten the two screws no. 3 [D] of the connector plate. The complete headblock assembly can now be lifted off.

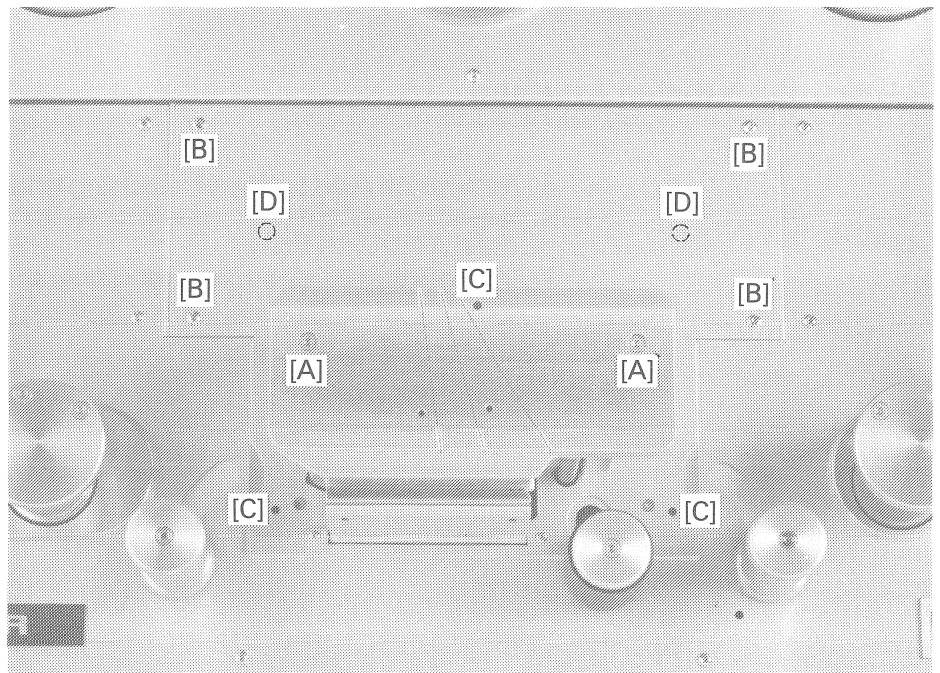

Fig. 3.1.16

### 3.1.17 Covers

---

#### Tape deck cover:

- Rear half**
  - Unfasten five allen screws no. 2.5.
  - Lift off the cover.
- Front half**
  - Remove the prestabilizer roller on the left side and the pinch roller on the right side of the headblock (allen screw no. 3).
  - Remove the head block (see Section 3.1.16).
  - Unfasten ten allen screws no. 2.5 of the tape deck cover.
  - Lift off the cover.

#### Wooden side panels:

- Unfasten four allen screws no. 4 on each side.

### 3.1.18 Push Button Rail

---

- Remove the "front half" of the tape deck cover, refer to the preceding section.
- Unfasten two allen screws no. 2.5 on top and two in the front, above the hinged cover.
- Pull up the push button rail on the leather side and carefully slide it out toward the left.
- Disconnect the 40-pin flat cable connector on the TAPE DECK DISPLAY DRIVER board.

### 3.1.19 Push Button Assembly

---

- Remove the push button rail according to section 3.1.18.
- Disconnect the flat cable connector on the left-hand side of the TAPE DECK DISPLAY DRIVER board.
- Unfasten the two allen screws no. 3 from above to remove the assembly.

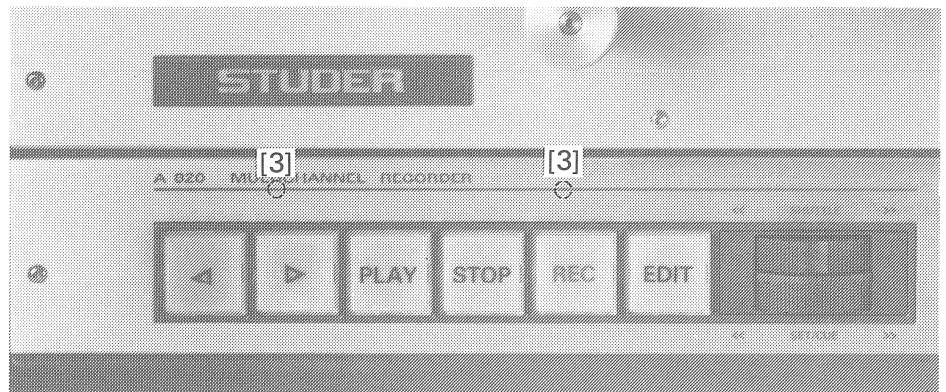

Fig. 3.1.19

### 3.1.20 Service Display

- Remove the push button rail according to Section 3.1.18.
- Disconnect the flat cable connector on the left-hand side of the TAPE DECK DISPLAY DRIVER board.
- Unfasten two allen screws no. 2.5 [D].

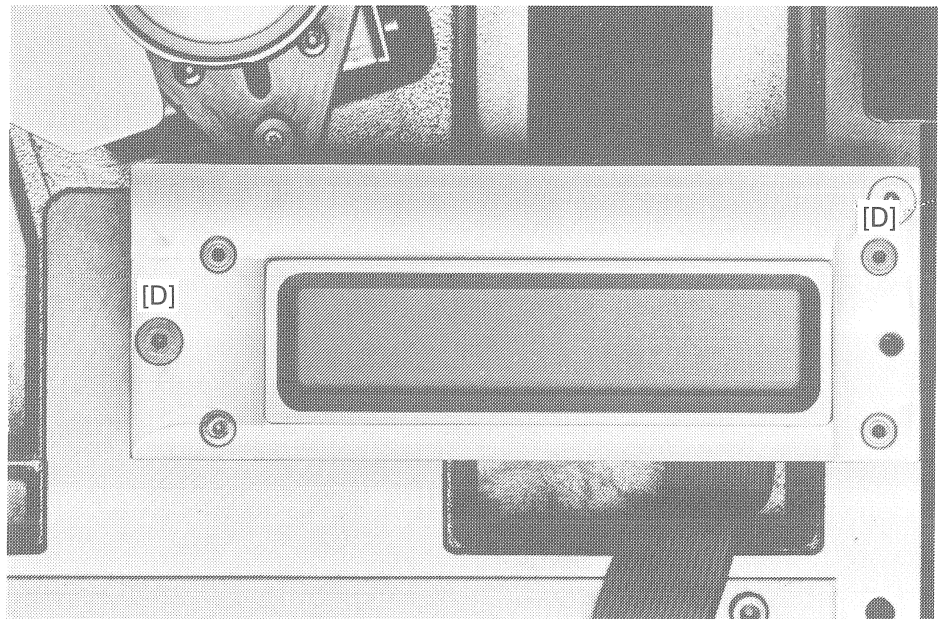

Fig. 3.1.20

## 3.1.21 Tape Lifter Assembly

---

- Remove the front half of the tape deck cover according to Section 3.1.17.
- Move the two slot shields over the shaft stub of the prestabilizer roller and shift them as far as possible in the direction of the brake solenoids.
- Unfasten three allen screws no. 3 [A] from underneath the chassis.
- Lift out the assembly.

### Reassembly instructions

- Manually turn the two cam discs counterclockwise to the stop position.
- Engage the swivel arm of the prestabilizer roller and the swivel arm of the ceramic tape guide in such a way that the control cam is located between them.
- Move the two slot shields over the shaft stub and make sure that the pin of each swivel arm engages in the small hole of the shields.

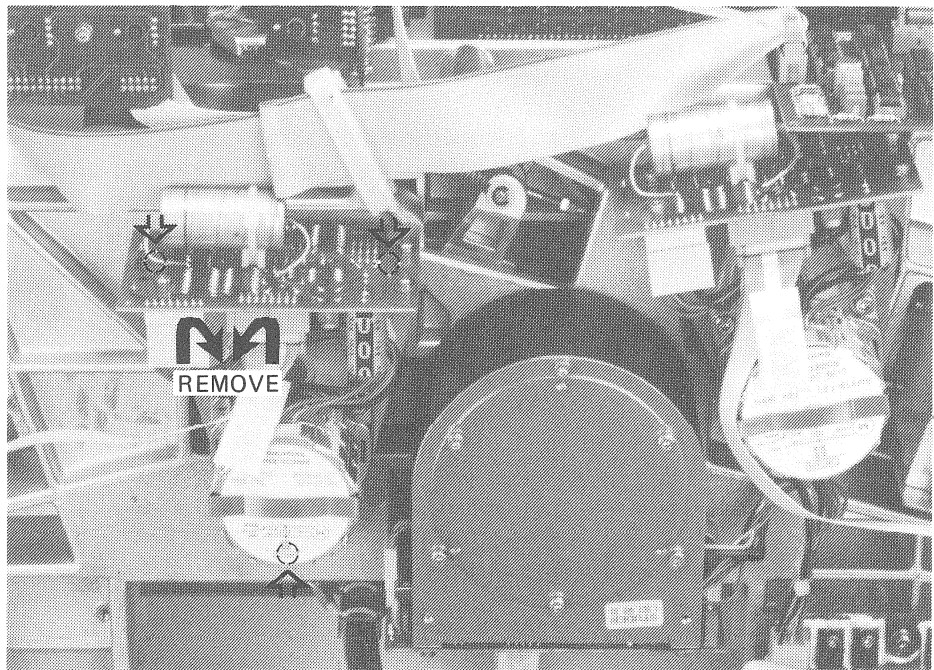

Fig. 3.1.21

## 3.1.22 Tape Tension Sensors

---

- Remove the headblock according to Section 3.1.16, the front half of the upper tape deck cover according to Section 3.1.17.
- Disconnect the flat cable connector on the bottom of the tape tension sensor.
- Unfasten the three special screws of each tape tension sensor (round head allen screwdriver No. 3), accessible through the cutouts at the end of the guide roller sleeve.

### 3.1.23 Tape-End Sensor (Light Barrier) with Guide Roller

---

- Remove the headblock according to Section 3.1.16 and the front half of the upper tape deck cover according to Section 3.1.17.
- Disconnect the flat cable connector on the sensor board.
- Unfasten the three special screws (allen screwdriver No. 3).

### 3.1.24 Tape Move Sensor

---

- Remove the headblock according to Section 3.1.16 and the front half of the upper tape deck cover according to Section 3.1.17.
- Disconnect the flat cable connector on the bottom.
- Unfasten the three special screws (allen screwdriver No. 3).

### 3.1.25 Adapter (incl. Brake Drum)

---

- Remove the rear half of the upper tape deck cover according to Section 3.1.17.
- Unfasten four allen screws no. 3 [1] through the holes next to the rotary knob. Carefully lift off the complete adapter (see Fig. 3.1.25).
- Unfasten the allen screw no. 4 in the center of the spindle.
- Lift the brake drum carefully.

**Important:** The height of the brake drum is adjusted with shims. Do not lose shims!

Neither the inside of the brake band nor the brake lining (reddish fabric) should be touched with ungloved hands!

**Reassembly instructions:** Make sure that the brake band does not become twisted – release the band by pressing against the armature of the brake solenoid!

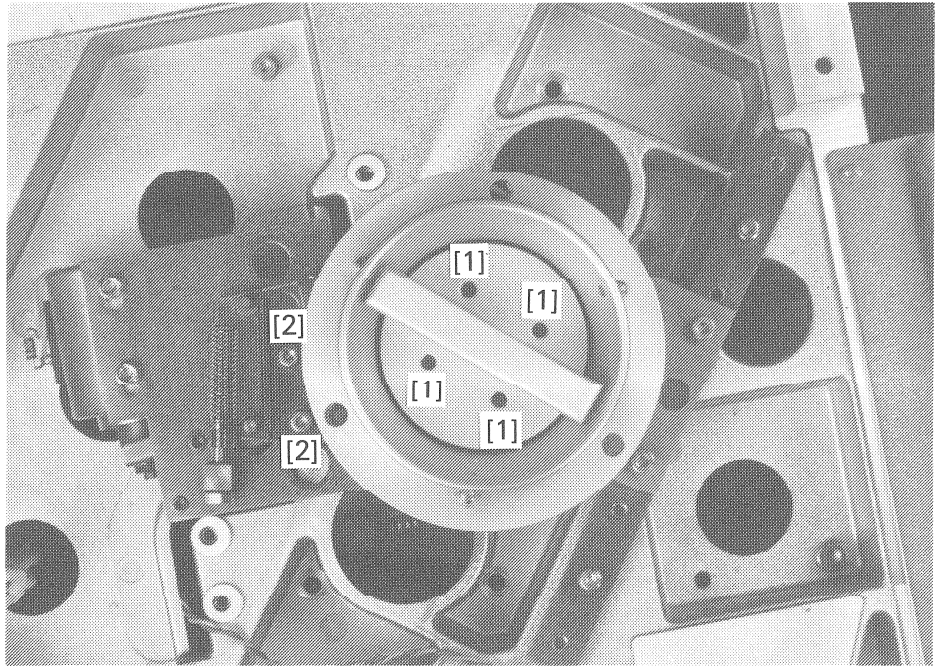

Fig. 3.1.25

## 3.1.26 Brakes

---

- Remove the adapter according to Section 3.1.25.
- Disconnect the supply conductors to the brake solenoid.
- To remove the brake assembly, unfasten the two allen screws no. 3 [2].
- Untie the brake band to be able to lift the brake chassis without making any damage.

### Reassembly instructions:

- Reinstall the assembly and take care of the brake band.
- Adjust the brake chassis according to Section 3.3.4.

## 3.1.27 Spooling Motors

---

- Remove the adapter according to section 3.1.25.
- Remove the brake drum according to the preceding section.
- Swing up the tape transport, see section 3.2.
- Disconnect the motor supply conductor on the SPOOLING MOTOR DRIVE AMPLIFIER.
- Disconnect also the flat cable connector on the MOTOR TACHO board.
- Unfasten the three allen screws no. 4. Support the motor from below during this work.
- Do not take the wrong socket for the supply on the AMPLIFIER. L is for the left-hand motor, R is for the right-hand motor.

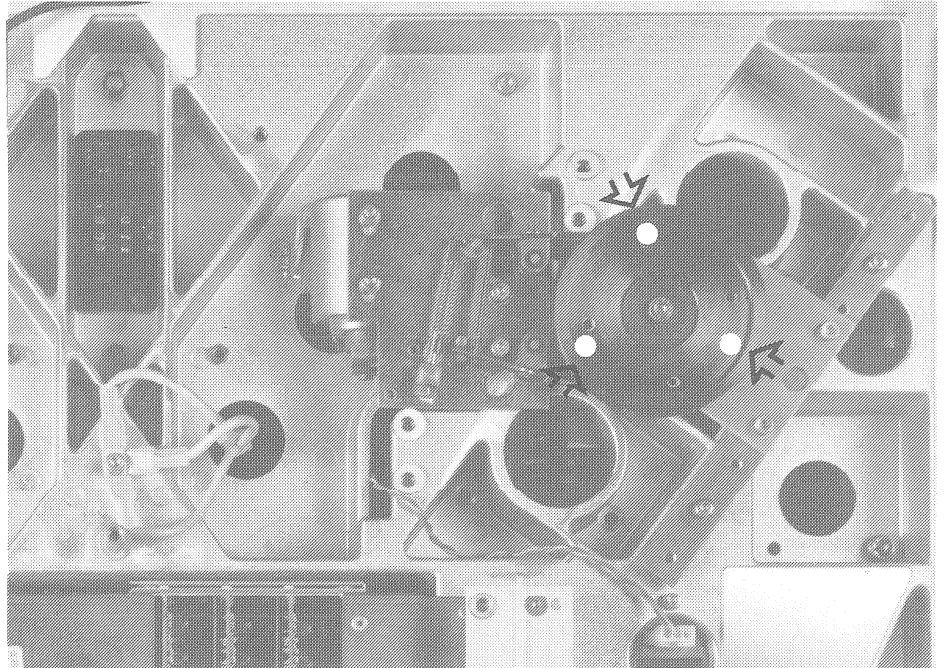

Fig. 3.1.27

### 3.1.28 Capstan Motor

- Remove the headblock according to section 3.1.16.
- Separate the multipoint connector (MOLEX) on the CAPSTAN MOTOR DRIVE AMPLIFIER.
- Unfasten the three special allen screws no. 3. Support the motor from below during this work.

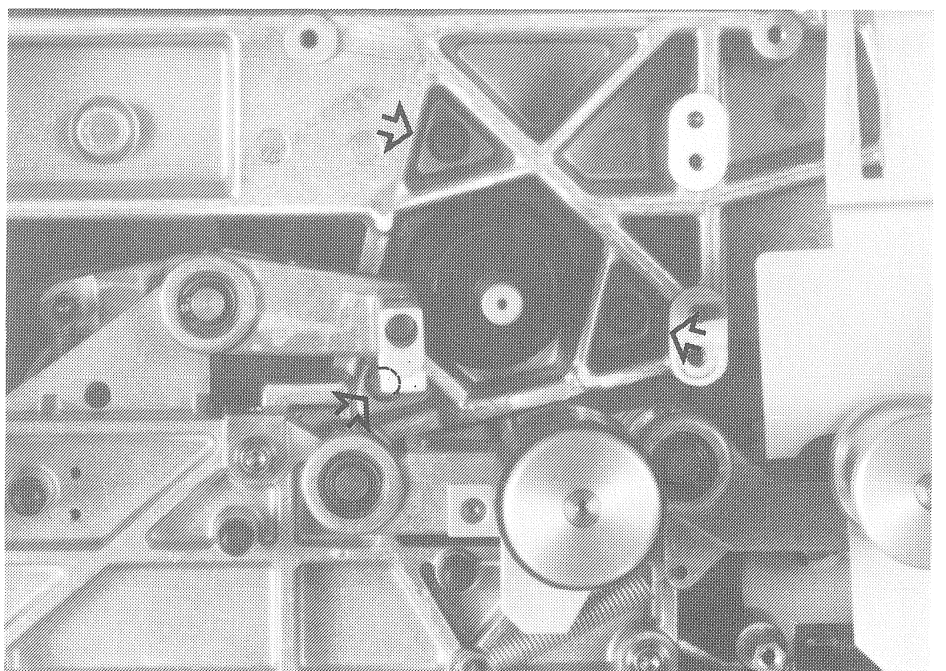

Fig. 3.1.28



3.1.29 Checking the Tape Movement across the Heads of 1" and 2" Machines

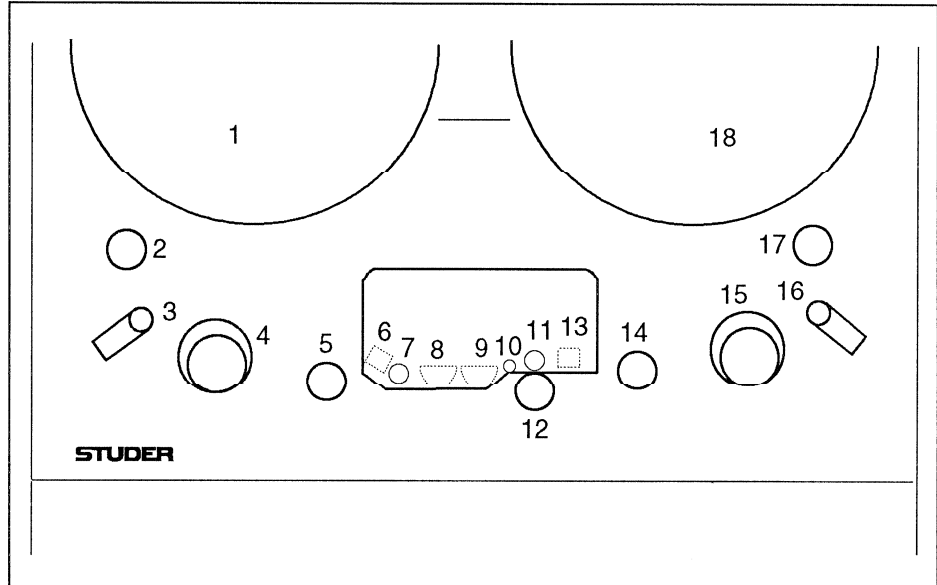

Fig. 3.1.29-1 [Nr. 1-18 = ELM Nr.]

**Preconditions:**

- All tape transport elements installed and cleaned.
- Check the function of the pivot ELM 13: shift the lever to the right and make sure that it tilts without binding.
- Shift the pivot ELM 13 to the left and check that it locks correctly. Insert the tape. When the mode is switched from PLAY to REVERSE PLAY and vice versa, the compensation lever should swing easily to the left and right.
- Check the tape tensions according to Section 3.1.8.
- The lifter pin ELM 10 must be adjusted. For adjustment refer to section 3.1.17.

**Testing the tape movement**

Wind the tape completely forward and backward. Move the tape forward and backward in shuttle mode at approx. 7.5 to 30 ips and subsequently in play mode at 7.5, 15, and 30 ips.

Observe the tape movement in front of the heads and the lifter pin (ELM 8, 9, 10) in both modes. The guide blocks (white ceramic parts) of the lifter pin mark the highest and lowest point of the tape path. The tape may contact the upper or lower guide block but under no circumstance should the tape get buckled or crest fallen.

At the head, the face (between both recesses) should be covered by the tape. For relatively narrow tapes approx. 0.05 mm of the head face can become exposed. If the tape edge is wavy, the face becomes visible intermittently (flashing). See Fig. 3.1.29-2. Before you make a final judgment on the tape movement, different tape batches and tape brands should be compared. The tape path alignment may be a compromise between the characteristics of various tape types.

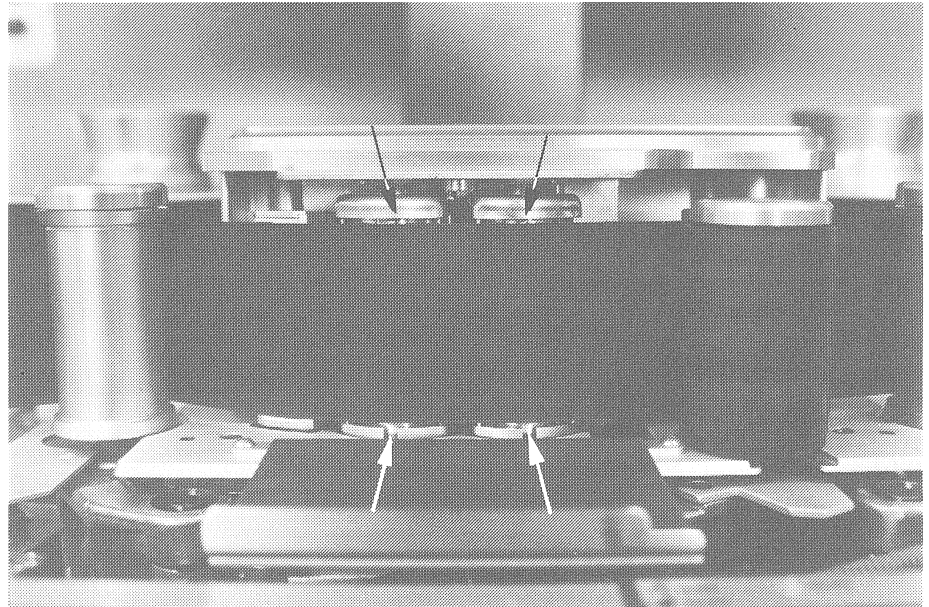

Fig. 3.1.29-2

### Centering ability of the tape movement

Check the centering ability of the tape movement.

- Remove the tape lifter pin ELM 10; the pivot ELM 13 must be installed.
- Load the tape and start the machine in PLAY at 30 ips.
- On the left side of the capstan shaft, push the running tape approx. 0.5 upward and downward with your finger. See Figs. 3.1.29-3 and 3.1.29-4.
- If the tape movement is correctly adjusted and the tape has no irregularities, the tape returns automatically to its normal path as soon as the interference is stopped. Note also the movement of the pivot ELM 13. Depending on the tape batch and brand, the tolerance of the tape movement is approx.  $\pm 0.1$  mm observed on the heads.
- Reinstall the tape lifter pin ELM 10.



Fig. 3.1.29-3

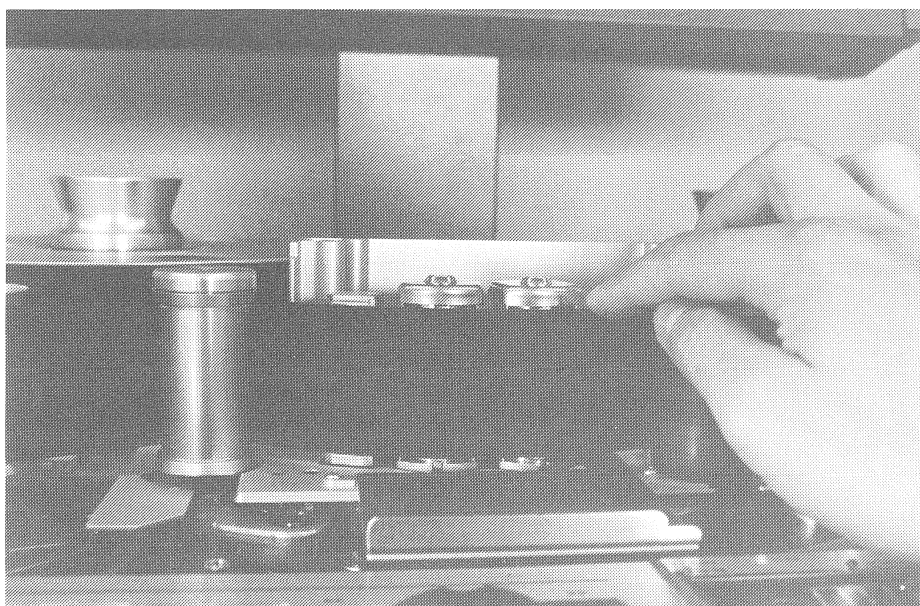

Fig. 3.1.29-4

## 3.1.30 Checking and adjusting the Tape Transport Elements (ELM)

Order Number

**Note:** If the tape is guided across the tape heads with acceptable precision, no adjustment should be attempted. If readjustment is unavoidable, the corresponding work must be performed with utmost care. It is essential to use the specified gauges for the corresponding work.

|  |   |                     |
|--|---|---------------------|
| <b>Required tools,<br/>gauges, shims</b> | ■ Precision gauge 1"<br>(A80/A800/A820/A827 25.35 mm) | 10.010.001.04       |
|  | ■ Precision gauge 2"<br>(A80/A800/A820/A827 50.75 mm) | 10.010.001.05       |
|  | ■ Reference block 1" + 2" (A80/A800/A820/A827)        | 41.05 10.010.001.01 |
|  | ■ Spring dynamometer 2" (0 to 2 kp)                   | 10.249.001.03       |
|  | ■ Tape Tension Gauge "Tentelometer" ¼"-1"             | 10.300.001.02       |
|  | ■ Tape Tension Gauge "Tentelometer" 2"                | 10.300.001.02       |
|  | ■ Shim 0.1 mm; Ø 8/12                                 | 1.010.058.23        |
|  | ■ Shim 0.12 mm; Ø 8/12                                | 1.010.059.23        |
|  | ■ Shim 0.15 mm; Ø 8/12                                | 1.010.060.23        |
|  | ■ Shim 0.18 mm; Ø 8/12                                | 1.010.061.23        |
|  | ■ Oiler   | 20.020.401.06       |
|  | ■ Micrometer (0 – 25mm)                               |                     |
|  | ■ Feeler gauge set                                    |                     |
|  | ■ Depth gauge or vernier calipers with depth gauge    |                     |
|  | ■ New, blank tape of the predominantly used brand     |                     |

**Tips and information**

- Ball bearings are sensitive to impacts and excessive axial loads!
- The shims, the contact surfaces of the rollers and the shaft shoulders must be absolutely clean!
- The roller height of ELM 2, 4, 5, 14, 15, and 17 should be corrected in small increments of 0.02 to 0.03 mm. If replacement assemblies are installed, the roller heights are preset by the factory.
- Before you insert the shims it is advisable to check their thickness with the micrometer. The correct roller height can be achieved by combining shims of various thicknesses.
- The roller height must be rechecked after each height correction!
- The tape lifter pin ELM 10 is set to the reference height. Neither the screws of the guide blocks (white ceramic parts) nor the adjustment screw [D] on the tape lifter Fig. 3.1.26 should be unfastened. Readjustments should only be performed by the factory!
- Shafts that have been touched manually should be slightly oiled (Rust Protection oil Order No.: 20.020.401.06).

**Checking and adjusting the reel flanges ELM 1 and 18**

Remove the headblock and the cover plates.  
The height of the reel flanges with reference to the **main chassis** should be 38.45 to 38.5 mm. The height can be adjusted by exchanging the shims below the brake roller.

**Important !**

Brake bands should not be bent. Do not touch the red brake surfaces with your hands. Both situations will considerably degrade the braking performance. Be careful when removing the brake roller: the shims tend to stick to the bottom of the brake roller.

**Shims**

0.1 mm; Ø 12/16  
 0.12 mm; Ø 12/16  
 0.15 mm; Ø 12/16  
 0.18 mm; Ø 12/16  
 0.5 mm; Ø 12/16

**Order No.**

1.010.062.23  
 1.010.063.23  
 1.010.064.23  
 1.010.065.23  
 1.010.066.23

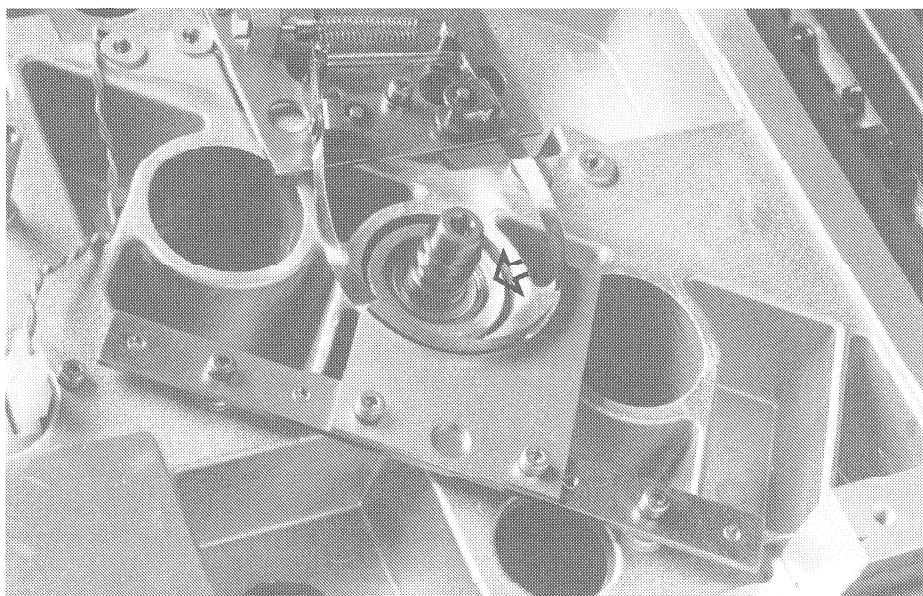

Fig. 3.1.30-1

**Rollers ELM 2 and 17**

With the aid of the gauges check the height of the rollers ELM 2 and ELM 17. The height of the corresponding roller is correct if it is in the middle of the tolerance range, i.e. the distance of the gauge to the roller rims should be identical on the top and the bottom. Refer to Figs. 3.1.30-2 and 3.1.30-3. The height is adjusted by inserting or removing shims at the location indicated in fig. 3.1.30-7.

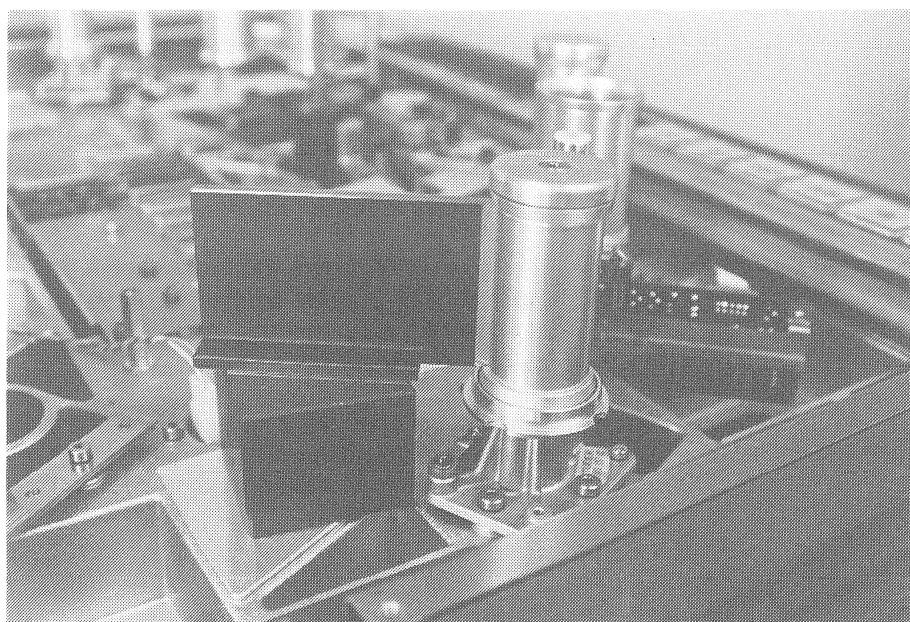

Fig. 3.1.30-2

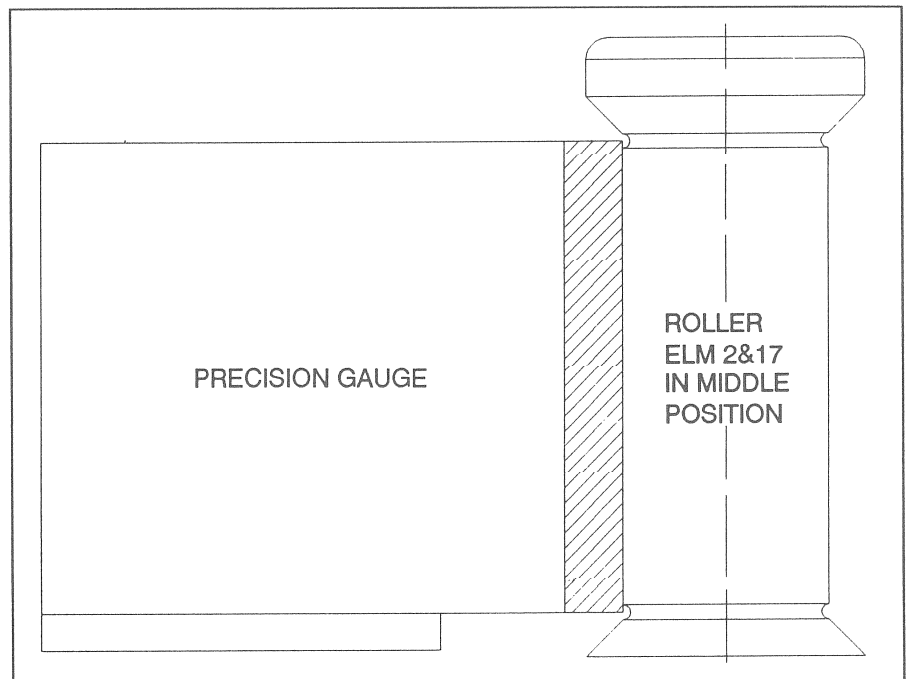

Fig. 3.1.30-3

**Tape tension sensor rollers  
ELM 3 and 16**

Check the angular alignment relative to the chassis surface.  
Transversely to the tape transport direction the error should not exceed  $\pm 0.05$  mm.



Fig. 3.1.30-4

### Adjustment procedure

Introduce a flat screwdriver size 3 or 4 into the opening of the tape tension sensor lever and carefully push it upward. Check the angular alignment with the gauge, according to Fig. 3.1.30-4. If the misalignment is still too large, the procedure should be repeated. If the air gap is at the bottom, the adjustment must be performed from the opposite direction.

**Important !** Never make the adjustment directly on the tape tension sensor roller or its shaft!

### Rollers ELM 4 and 15

The height of the rollers ELM 4 and ELM 15 can be checked with the aid of the gauge. The roller position is correct if the gauge is in the lower section of the tolerance range, i.e. the gauge should not touch the upper roller rim or only lightly, however, without interfering with its rotational movement. Refer to Figs. 3.1.30-5 and 3.1.30-6.

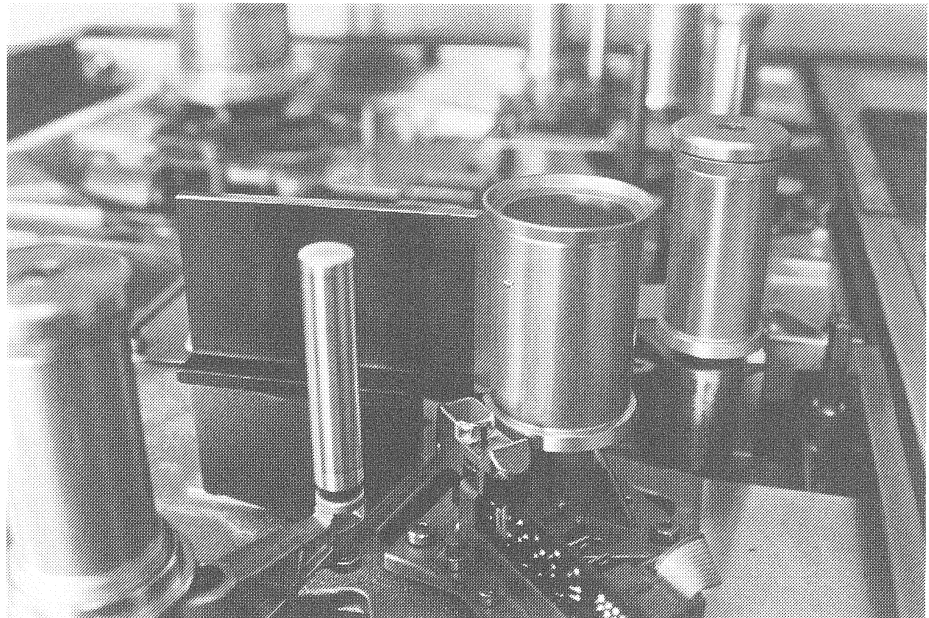

Fig. 3.1.30-5

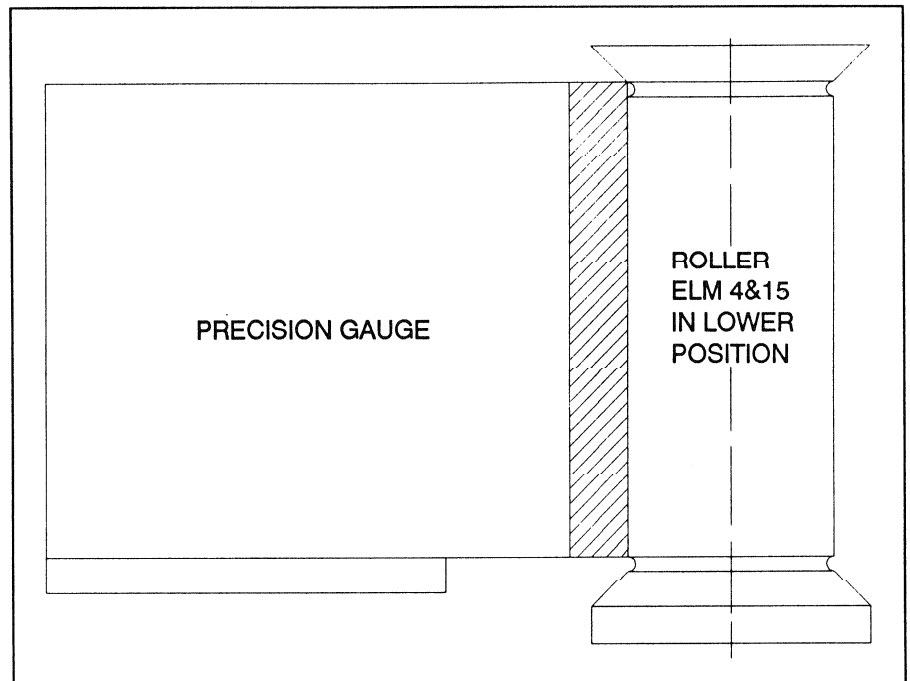

Fig. 3.1.30-6



Adjusting the roller ELM 4

The height of this roller is adjusted by inserting or removing shims. Refer to Pos. 1.5, Fig. 3.1.30-7.

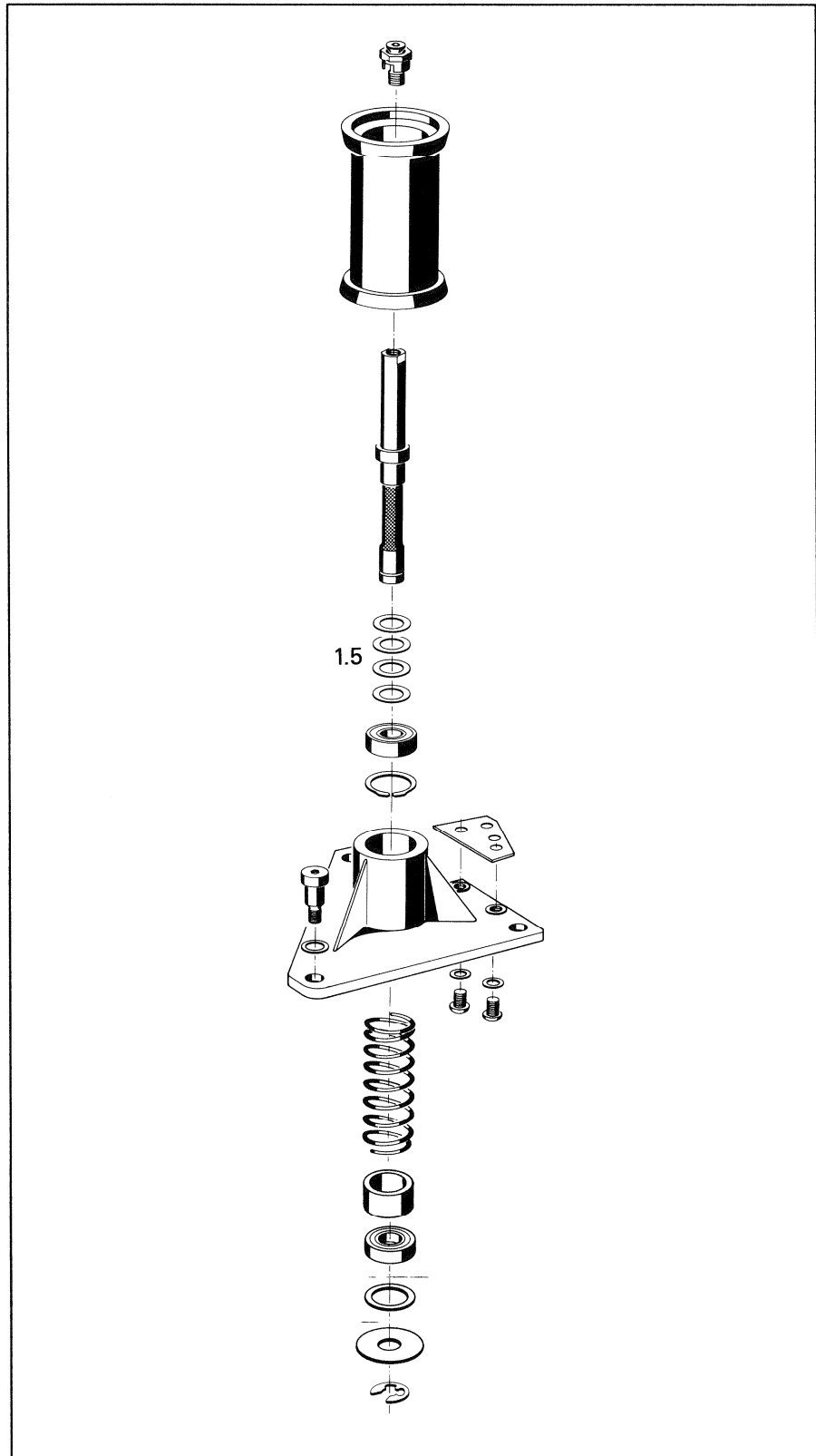

Fig. 3.1.30-7

**Adjusting the rollers  
ELM 15**

The height of this roller is adjusted by inserting or removing shims at pos. 1.4,  
Fig. 3.1.30-8  
In most cases it is not necessary to adjust this roller.

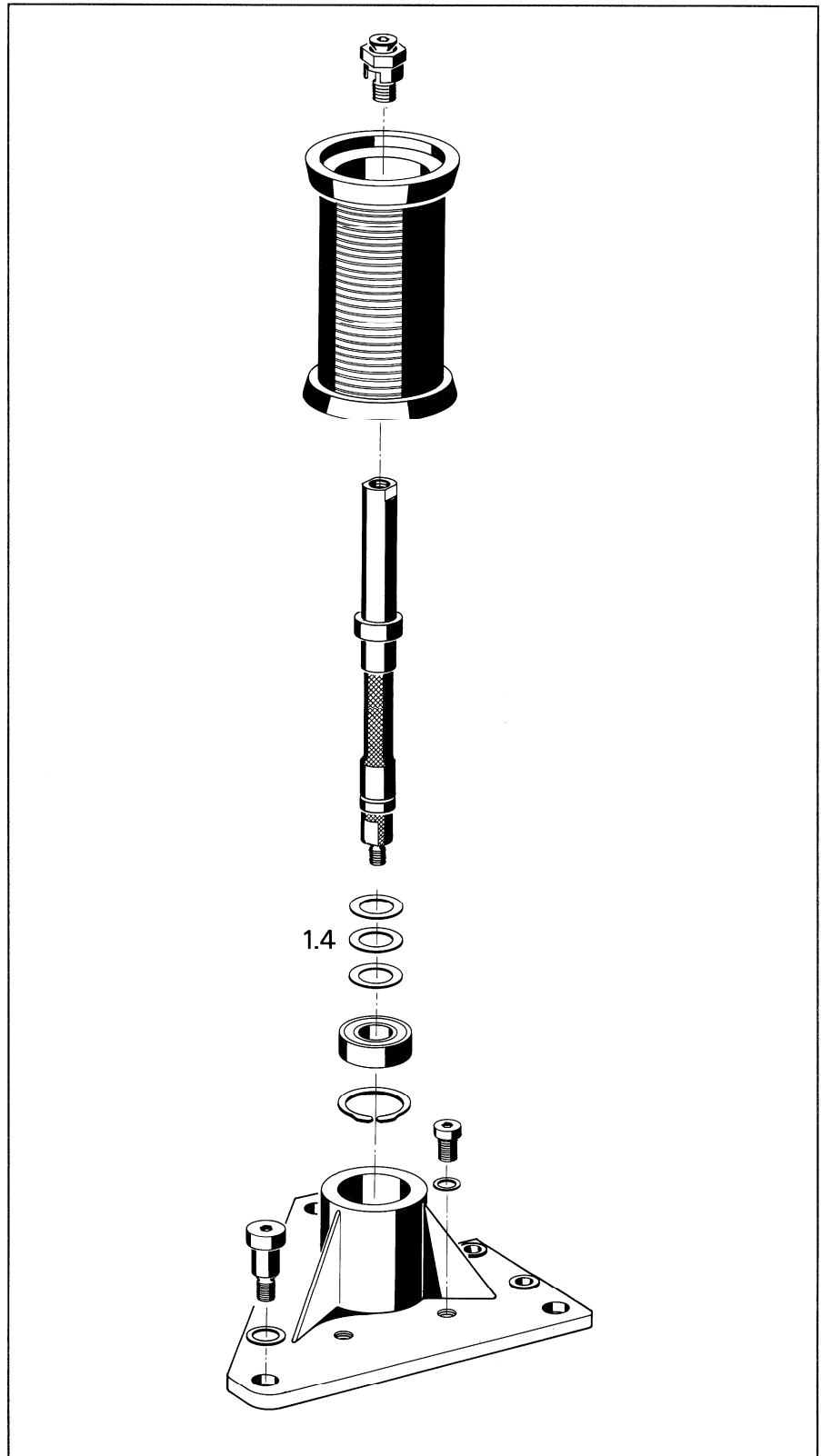

Fig. 3.1.30-8

**Rollers ELM 5 and ELM 14**

Check the height of rollers ELM 5 and 14 with the aid of the gauge. The rollers are correctly aligned if they are in the upper section of the tolerance range, i.e. the gauge should not touch the lower roller rim or only lightly, however, without interfering with their rotational movements. Refer to Figs. 3.1.30-9 and 3.1.30-10.

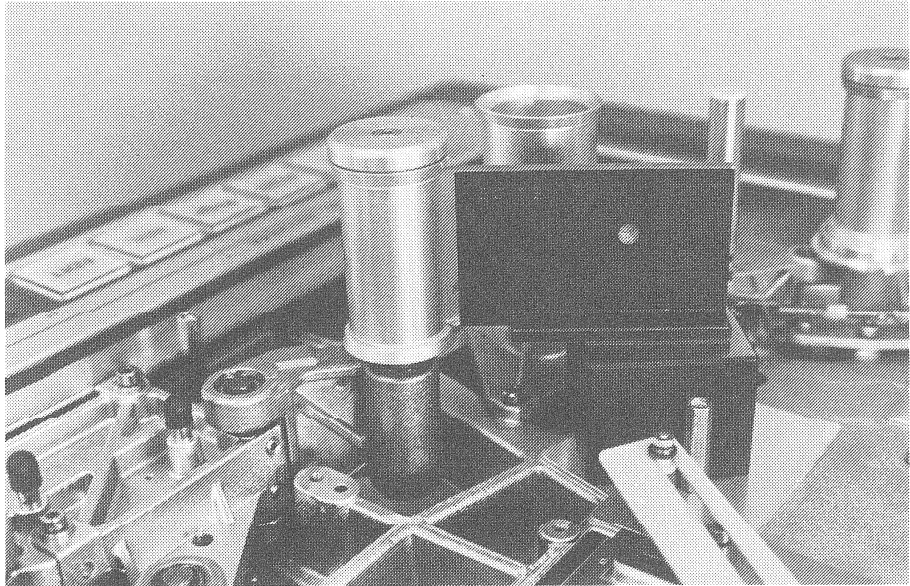

Fig. 3.1.30-9

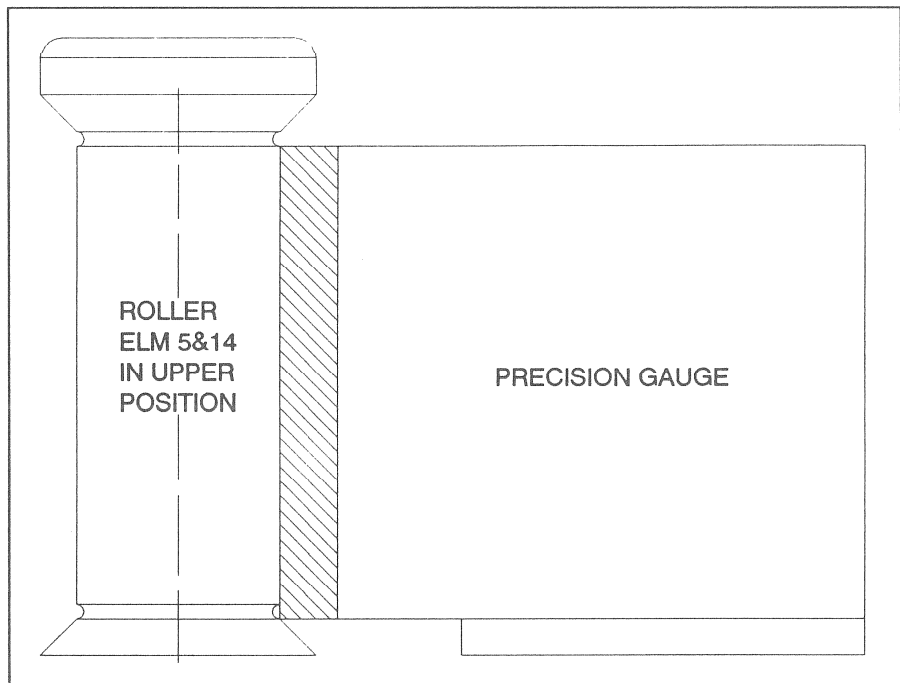

Fig. 3.1.30-10

### Adjusting the rollers ELM 5 and ELM 14

For the adjustment proceed according to the following steps:

1. Check the roller height with the aid of the gauge Fig. 3.1.30-10 and the tape movement.
2. If the roller is too high, the shim combination 0.1 mm and 0.12 mm can be tried.
3. If the roller is too low, the shim combination 0.12 and 0.15 mm can be tried. etc.
4. When the correct roller height has been found, install the shims below the shaft shoulders (F), Fig. 3.1.30-22.

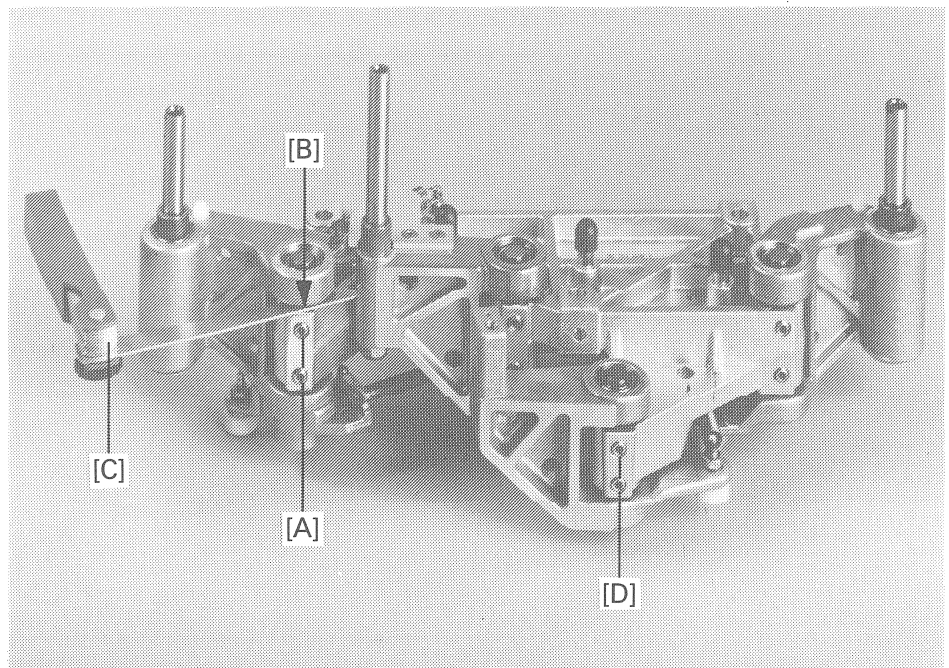

Fig. 3.1.30-11

### Pinch roller ELM 12

Adjusting the height of the pinch roller ELM 12.

1. Remove the headblock and the pinch roller assembly.
2. With the aid of the feeler gauge (C) measure the distance between the two die-cast aluminum parts at ELM 12, Fig.3.1.30-11 and write it down.
3. Unfasten the adjusting screws (A) of ELM 12.
4. Increase the distance by 0.1 mm if the pinch roller is to be raised, or decrease the distance if the pinch roller is to be lowered.
5. Firmly tighten the adjusting screws of ELM 12.
6. Reinstall the pinch roller assembly and the headblock.
7. Check the pinch roller height by means of the tape travelling at the correct height.

## Pinch roller pressure

Adjustment of the pinch roller pressure ELM 12. Refer to section 3.1.6 Fig. 3.1.6-3. The correct pinch roller pressure is important for perfect tape travel!

### Attention!

This value is only valid with pivot ELM 13!

## Pendular direction of the pinch roller ELM 12

Adjustment of the pendular direction of the pinch roller ELM 12. The pendular direction must be transverse to the transport direction. See Fig. 3.1.30-12.

In the engaged position of the pinch roller, the upper and lower lobes (N) of the pinch roller shaft must point in the direction of the capstan shaft.

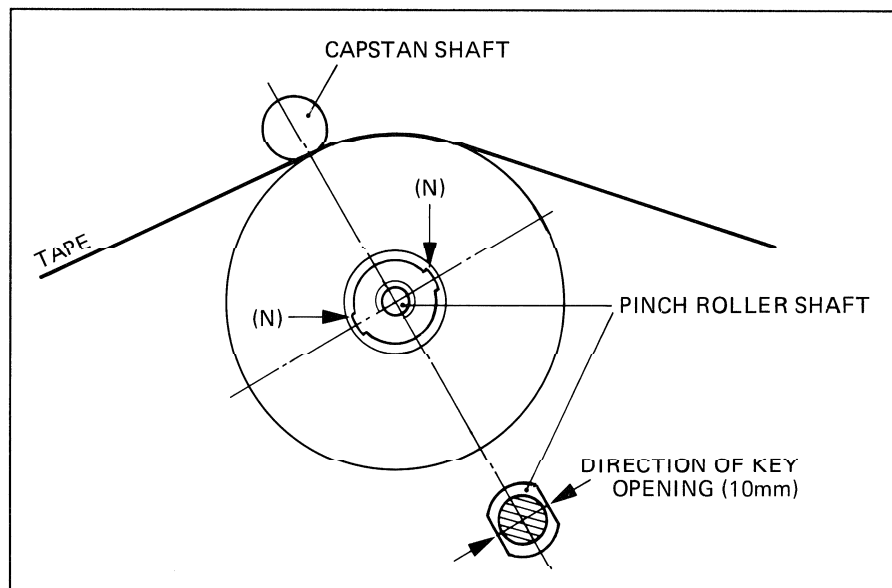

Fig. 3.1.30-12

### 3.1.31 Fine-Adjustment of the Tape Movement

For ELM designations refer to Fig. 3.1.29-1.

In each correction step, the rollers should not be raised or lowered by more than 0.02 to 0.03 mm. Check the forward and reverse tape movement after each step. Refer to Section 3.1.15.

**Error:**  
Tape creeps slightly  
upward

Correction steps for forward SHUTTLE and PLAY:

1. **Step:** Set roller ELM 2 lower
2. **Step:** Set roller ELM 5 lower
3. **Step:** Check roller ELM 4 according to section "Rollers ELM 4 and 15"
4. **Step:** Set roller ELM 2 lower  
etc.

Correction steps for reverse SHUTTLE and PLAY:

1. **Step:** Set roller ELM 17 lower
2. **Step:** Set roller ELM 14 lower
3. **Step:** Check roller ELM 15 according to section "Rollers ELM 4 and 15"
4. **Step:** Set roller FI M 17 lower  
etc.

**Error:**  
Tape creeps slightly down-  
ward

Correction steps for SHUTTLE and PLAY:

1. **Step:** Set roller ELM 2 higher
2. **Step:** Set roller ELM 5 higher
3. **Step:** Set roller ELM 4 higher
4. **Step:** Set roller ELM 2 higher  
etc.

Correction steps for reverse SHUTTLE and PLAY:

1. **Step:** Set roller ELM 17 higher
2. **Step:** Set roller ELM 14 higher
3. **Step:** Set roller ELM 15 higher
4. **Step:** Set roller ELM 17 higher  
etc.

The correction steps have to be repeated until the tape movement corresponds with the section 3.1.15.

## 3.2 Circuit Discriptions

### 3.2.1 Power Supply Electronics 1.820.350 GRP01 – GRP14

**Function:** Supplying the entire machine with a smoothed DC voltage (approx. 45–55 VDC). The power supply unit features a line voltage selector (GRP3/ELM1+2) for 110/220 V.

**Circuit description:** The power supply electronics is located in a separate, enclosed housing. The line voltage is connected to a 3-pin connector (GRP1/ELM1). The insulation of the power supply corresponds to IEC65, protection category 1; the protective ground is connected to the chassis ground (GRP13/ELM1). An additional load (e.g. synchronizer) can be connected to the power socket (GRP1/ELM2). The two toroidal core transformers GRP4 and GRP5 are connected either in parallel (110 V operation) or serially (220 V operation) via the power switch (GRP2/ELM1), the two chokes GRP6 and GRP7 (for limiting the inrush current), and the line voltage selector (GRP3/ELM1+2).

The four secondary windings are connected to four rectifiers (GR8/ELM1–4) and are connected in parallel. The three electrolytic capacitors (GRP9/ELM1–3) are interconnected by two bus bars (+STABIN, 0STABIN). The DC output voltages are taken to the connector (GRP11) via the four fuses (GRP10/ELM1–4) which are allocated as follows:

- F1 (16A) Spooling motors
- F2 (16A) Stabilizer +/- 15 V 1.820.871/873 GRP 31
- F3 (6.3A) Stabilizer + 5.6 V/24V ±26V 1.820.872 GRP 32
- F4 (6.3A) Audio control

The inrush current is limited by the relay (GRP9/ELM4) and the PTC resistors. This relay is controlled by the POWER FAIL DETECTOR 1.820.791 (GRP14/ELM1) by which also the DC voltage is monitored. This assembly supplies the T-PWRON signal (HIGH = AC available).

### 3.2.2 Power Fail Detector 1.820.791 GRP14

**Function:** Monitoring the AC voltage  
Controlling the relay for limiting the inrush current

**Circuit description:** The AC voltage on the secondary side is scanned via the voltage dividers R1, R3, and R5, and connected to the comparator IC1/1. The reference voltage is produced via the resistance divider R4/R7. C3 is charged via R8 and R9. With a line frequency of 50/60 Hz the comparator changes state in the 100/120 Hz rhythm and discharges C3. If for example a half-wave is missing, C3 is not discharged, the positive input of IC1/2 shifts relative to the reference and activates Q1, i.e. T-PWRON changes to LOW (power failure indication).

The relay (for limiting the inrush current in the power supply) is controlled by comparator IC2/1. If the DC voltage (+STABIN) is greater than 25 VDC, the current source IC3 is switched on via Q2, the relay picks up and bypasses the four PTC resistors in the power supply 1.820.350.

### 3.2.3 Power Supply Electronics 1.820.353 GRP01 – GRP11

**Function:** Supplying the entire machine with a smoothed DC voltage (approx. 45 to 55 VDC). The power supply features a line input voltage selector (GRP2, EL1–5) (Philbert circuit) through which the machine can be connected to any AC power source supplying 100 V to 240 V  $\pm 10\%$  (50 to 60 Hz).

**Circuit description:** The power supply electronics is located in a separate, enclosed housing. The line voltage is connected to a 3-pin connector (GRP01/EL01). The insulation of the power supply corresponds to IEC65, protection category 1; the protective ground is connected to the chassis ground (GRP01/ELM03). An additional load (e.g. synchronizer) can be connected to the power socket (GRP01/ELM02). The line voltage is connected in parallel to three identical transformers 1.862.625 (GRP4, 5, 6) via the SOFT START UNIT 1.820.830.

Each of these transformers features two 100 V and two 18 V windings which are connected either serially and/or in parallel by means of the Philbert circuit (GRP2/EL1 to EL5) for adaptation to the available line voltage.

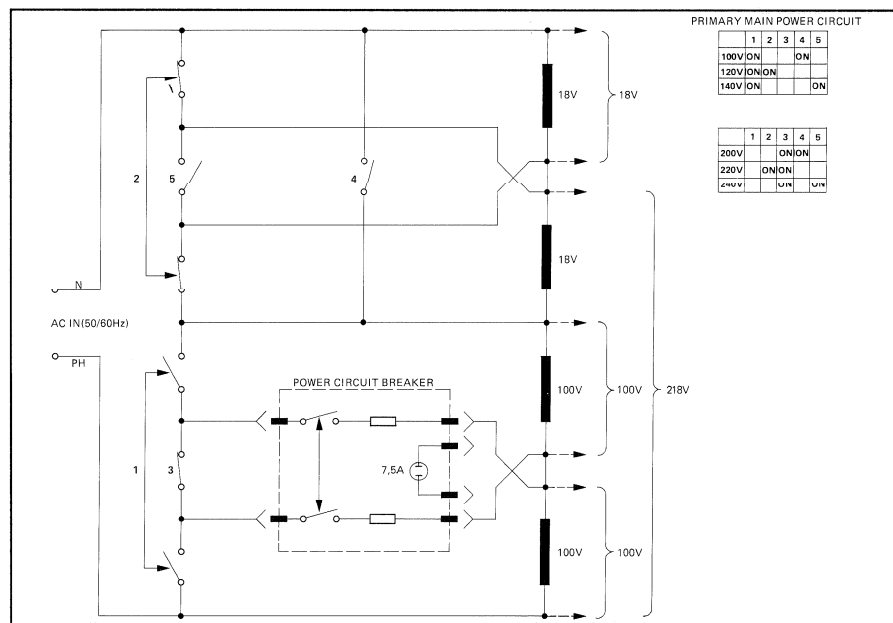

Fig. 3.4.2 Diagramm of the primary wiring

The power available from each transformer is 300 VA; each primary winding is monitored with a temperature sensor ( $T_{off} = 120^{\circ}\text{C}$ ). The six primary windings are connected symmetrically in parallel and taken to two rectifiers (GRP7/EL1–6) each. The three electrolytic capacitors (GRP8/EL9, 10, 11) are interconnected with two bus bars (+STABIN, 0STABIN) which are supplied by the six rectifiers. The DC output voltages are connected via four fuses (GRP10/EL1, 2, 3, 4) to the connector (GRP11) which are allocated as follows:

- F1 (16A) SPOOLING MOTORS
- F2 (16A) STABILIZER  $\pm 15\text{V}$  1.820.871/873 GRP 31
- F3 (6.3A) STABILIZER +5.6V/24V ( $\pm 26\text{V}$ ) 1.820.872 GRP32
- F4 (6.3A) AUDIO CONTROL

The SOFT START UNIT (GRP3) supplies the electrically isolated logic signal of the AC voltage monitoring (T-PWRON).



### 3.2.4 Main Soft Start Unit 1.820.830

**Function:**

- Limiting the peak inrush current.
- Detecting and transmitting a power interruption or failure.
- Power filter.

**Circuit description:**

The inrush current is limited in the feeder line of the phase on the primary side by means of power resistors (R1, R3, R6). After the power-on phase the transistors are bypassed with an AC switch (Q7 POWER MOSFET) and a power rectifier (D2).

An auxiliary voltage is required for controlling the AC switch and for monitoring the line voltage. This auxiliary voltage is derived via C5, C8 from the mains, rectified by D4, D5, input to C4, and stabilized to +15 VDC by means of DV3, DV4, DV5. The auxiliary voltage generation functions with any mains voltage from 85 VAC to 265 VAC (50 to 60 Hz).

The power failure or interruption is detected by means of resistors R31, R32 which convert the rectified current into a voltage, which is amplified by IC2 and supplied to the retriggerable monoflop IC 3/2. If a half wave is missing, the output Q changes to LOW and the MOSFET blocks. This signal is transmitted via the optocoupler IC1 to the secondary side and retransmitted as the T-PWRON logic signal. High corresponds to AC available, the LED DL1 is light.

The monoflop IC3/1 and the AND gate IC4 constitute an ON delay (approx. 350 ms). The monoflop is enabled via the comparator IC5 (auxiliary voltage greater than 10 V).

The phototransistor is supplied by the rectified secondary supply voltage +STABIN (30 ... 63 VDC) via the series pass transistor Q6.

The filter comprising the capacitors C1 and C3 as well as the current compensated choke represents a low pass that suppresses the noise voltages caused by the switching power supplies. This interference suppression conforms to VDE 871 category B.

**Test points:**

- P2 : GND secondary
- P3 : AC-DETECT
- P4 : 5.0 V secondary
- P5 : T-PWRON (H = AC available)
- P6 : GND primary
- P7 : 15 VDC auxiliary voltage primary
- P8 : Primary logic signal PWRON
- P9 : +STABIN 1 (30 ... 63 VDC) secondary supply
- P10: MOSFET enable signal

### 3.2.5 $\pm 15\text{V}$ , 24V Stabilizer (1.820.871.81)

---

This DC/DC stabilizer converts the internal DC supply voltage of nominally 40 V (30 V ... 60 V) to  $\pm 15\text{ V}$  (9 A each) and 24 V (5 A). The converter is implemented with a single-ended flyback oscillator with primary current monitoring. The pulse width modulator IC2 is externally synchronized with 76 kHz. The hunt range of the PLL circuit (IC5) serially connected to the input is 60 kHz to 85 kHz. The modulator monitors the supply voltage which must be between 30 V and 60 V. The monitoring range can be adjusted with R5.

In order to monitor the output voltages the +15 V supply is measured. A subvoltage, adjustable with R35, is compared with the reference in IC6. Via the optocoupler DLQ1 the error signal controls the pulse width of the PW modulator IC2.

An overvoltage trip (IC7 and IC8) is also available for monitoring the two 15 V supply voltages. When these respond, the control pulses of the switching FETs are blocked via the optocoupler DLQ2.

The 24 V supply voltage is surge protected in open-circuit mode by means of a Zener diode with a power transistor (D10; Q7).

The heat sink temperature is monitored by a thermal switch (S1) which at 90°C interrupts the internal supply voltage of 14 V.

In addition to the power winding the power transformer also features a snubber winding. The voltage induced in this winding is suitably conditioned and used for the current limitation, adjustable with R12. In the event of an overload the current is thus effectively limited.

### 3.2.6 $\pm 27\text{V}$ , +24V, +5.6V Stabilizer (1.820.872.00 + 1.820.872.81)

---

This stabilizer converts the internal DC supply voltage from nominally 40 V (30 V ... 60 V) to  $\pm 27\text{ V}$  (0.4A), +24V (0.8A) and +5.6V (10 A). Because it is necessary to monitor the output voltages of all sources, two individual switching regulators are used. Both are single-ended flyback oscillators with primary current monitoring. Both pulse width modulators (IC2, IC4) are synchronized externally with 76 kHz. (Hunting range of the PLL circuit: 60 kHz to 85 kHz). Both modulators are monitored for overvoltage and undervoltage relative to the input voltage (R7). The admissible range is 30 V to 60 V.

For monitoring the output voltages the +24 V supply is used for the upper regulator; a subvoltage, adjustable with R33 is compared with the reference in IC6. The difference signal controls the pulse width of the modulator IC4 via the optocoupler DLQ1.

For the lower regulator, the same method is used for the +5.6 V supply via IC9 and DLQ2. In addition an overvoltage trip (IC10 with DLQ3) is used which in the event of an overvoltage blocks the control pulses of the switching FETs.

In addition to the primary winding the power transformers of the two regulators also feature a snubber winding. The voltage induced in this winding is suitably conditioned and used for limiting the current. In the event of a short circuit the current is thus effectively limited.

### 3.2.7 $\pm 27V, +24V, +5.6V$ Stabilizer (1.820.872.82)

---

This stabilizer converts the internal DC supply voltage from nominally 40 V (30 V ... 60 V) to  $\pm 27$  V (0.4A), +24V (0.8A) and +5.6V (10 A). Because it is necessary to monitor the output voltages of all sources, two individual switching regulators are used. Both are single-ended flyback oscillators with primary current monitoring. Both pulse width modulators (IC2, IC4) are synchronized externally with 76 kHz. (Hunting range of the PLL circuit: 60 kHz to 85 kHz). Both modulators are monitored for overvoltage and undervoltage relative to the input voltage (R7). The admissible range is 30 V to 60 V.

For monitoring the output voltages the +27 V and the +24 V supply voltages are added in the upper regulator; a subvoltage adjustable with R20 is compared with the reference in IC8. The difference signal controls the pulse width of the modulator IC2 via the optocoupler DLQ1.

For the lower regulator, the same method is used for the +5.6 V supply via IC9 and DLQ2. In addition an overvoltage trip (IC10 with DLQ3) is used which in the event of an overvoltage blocks the control pulses of the switching FETs.

In addition to the primary winding the power transformers of the two regulators also feature a snubber winding. The voltage induced in this winding is suitably conditioned and used for limiting the current. In the event of a short circuit the current is thus effectively limited.

### 3.2.8 $\pm 15V, +24V$ Stabilizer (1.820.873.00 + 1.820.873.81)

---

This stabilizer converts the internal DC voltage of nominally 40 V (30 V ... 63 V) to +15 V (10 A or 14 A respectively), to -15 V (8 A or 12 A respectively), and +24 V (3.5 A or 0.5 A respectively). This is a current controlling pulse width modulator (IC1) which is externally synchronized with 76 kHz (hunting range: 60 to 85 kHz). The power is transmitted by a single-ended converter. The +15 V are measured and control the duty factor of the switching FETs (Q1, Q2, Q3) via the optocoupler DLQ1.

The filter choke L2 features three windings on the same core. In this way also the voltages of the non-monitored sources are largely stabilized.

The safety elements provided are a fuse for the +24 V source, an overvoltage trip (DLQ2) for the two 15 V supplies, as well as the foldback behavior for limiting the power in the event of an external overload. In addition the pulse width modulator interrupts the power flow if the supply voltage drops below 30 V or the temperature of the heat sink exceeds 90°C. In this case switch S1 opens, interrupts the supply of the PLL (IC3), and the modulator can no longer generate a ramp.

3.2.9 Spooling Motor Drive Amplifier 1.820.875.82 GRP20:ELM1 (left)/ELM2(right)

**Function:** ■ Controlling a DC spooling motor based on a pulse width modulated control signal supplied by the SPOOLING MOTOR DRIVER 1.820.759 (GRP20/ELM40). Supply voltage – 30 ... 63 V, output current 0...20 A

**Circuit description:** The pulse width modulated signal at the input of this stage is taken via a Schmitt trigger to EXOR devices which split the signal into a noninverted and an inverted signal and take it to the driver stages (Q1-Q8). Two pulse transformers control the four electronic switches (MOSFETs Q13-Q16) arranged in a full bridge configuration which constitute the basic element of the circuit. These switches open and close in pairs and in opposite state with a clock frequency of 76.8 kHz. If the switch pairs are alternately opened and closed for the same duration (duty factor 50%), a balanced square-wave voltage is generated on points A and B. A mean current of 0 ampere flows through the inductor L of the low pass filter, i.e. the motor does not rotate. If the square-wave voltage becomes asymmetrical (unequal on/off times), a mean direct current flows through the inductor and consequently through the motor. The magnitude and direction of the current flow through the motor can thus be controlled with the duty factor alone.

The mean direct current is measured by a shunt with a differential amplifier. The output signal of the current-to-voltage converter AN-ICLD/RD (312.5 mV correspond to 1 A) is returned to the input of the SPOOLING MOTOR DRIVER 1.820.759 (GRP20/ELM40) and functions as a negative feedback.

**Test points:**

- TP1 = GND
- TP2 = AN-ICLD/ICRD
- TP3 = GND
- TP4 = PWMPL-HI/PWMPL-HI

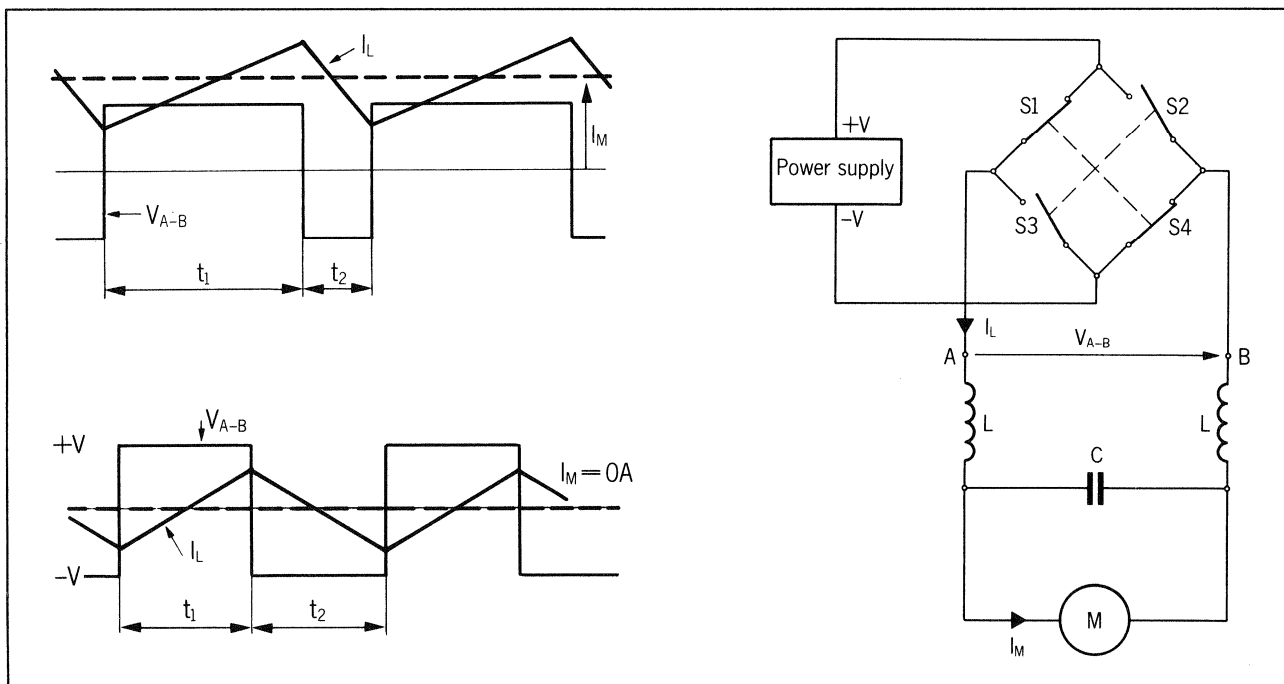

Fig. 3.2.9 Related schematics

### 3.2.10 Power Fail Sense Board 1.820.869.00 GRP 23

---

**Function:** ■ Electronic deceleration aid for the spooling motors in the event of a power failure to prevent formation of tape loops.

**Circuit description:** When the spooling motors are in operation but not energized, the DC motors function as generators and supply an induced voltage (EMK) on their terminals. This voltage is eliminated by one controlled constant current source each (IC1 and Q1 with R3, IC2 and Q5 with R17) which are brought into the circuit by the relay K1 (break contact).

The constant current source operates in two stages. The changeover is performed by the Zener diodes D4/5 with the transistors Q2 and Q4. If the terminal voltage of the motor is approx. 10 V, a larger current flows (R7 parallel R6, R13 parallel R14). The relay control is implemented with Q3 and is based on the presence of the +/-15 V supply voltage which is normally active, i.e. the break contacts are open. The monitoring circuit is located on the SPOOLING MOTOR DRIVER 1.820.759 (GRP 20/ELM44), and the monitoring signals is transmitted via Q6 to the POWER FAIL SENSE BOARD PIN15.

### 3.2.11 Pinch Roller Gate 1.820.831 GRP 60

---

**Function:** ■ Additional hardware monitoring of the right-hand pinch roller assembly (TAPE LIFTER MOTOR RIGHT GRP 20/EL10) for preventing roller engagement at speeds greater than 1.5 m/s.  
 ■ Visual status indication of the two motor tachos (TACHO SENSOR 1.820.771) and the tape move sensor (MOVE SENSOR 1.820.770 GRP45).

**Functional description:** As soon as the tape speed becomes greater than approx. 1.4 m/s (approx. 30 ips + 50%), the outputs of the comparators (IC 3) change to log. 0 (ORed). If the feedback of the light barrier on the right-hand TAPE LIFTER CONTROL 1.820.773 (signal TD-RARP1 & TD-RARP2) detect a transition attempt to the PLAY position (TD-RARP1 = TD-RARP2 = 0), the flip flop IC7 is set and the right-hand tape lifter motor is immediately disabled (TD-RAREN = 1).

If the jumpers is set in position P13/P14, the flip flop IC7 is reset via the monoflop IC6 as soon as the tape speed drops below a certain value --> the right-hand tape lifter motor is reenabled. If the jumper is missing or set in position P12/P13, the flip flop IC7 is reset only when the machine is switched off and on again.

On the front of the PINCH ROLLER GATE there are 7 red status LEDs. The 6 lower LEDs provide information on the correct behavior of the various tacho signals (see Fig. 4). The upper red LED is light if the tape speed is greater than approx. 1.4 m/s.

The various tacho signals are available on the 6 test points P10, P11, P15, P16, P17, P18, P19.

## Status indications:

|      |                                 |
|------|---------------------------------|
| DL 1 | Tape speed > 1.5 m/s            |
| DL 2 | Motor tachometer right TD-TMR 1 |
| DL 3 | Motor tachometer right TD-TMR 2 |
| DL 4 | Motor tachometer left TD-TML 1  |
| DL 5 | Motor tachometer left TD-TML 2  |
| DL 6 | Move sensor TD-MOVE 1           |
| DL 7 | Move sensor TD-MOVE 2           |

## Test points:

|     |                                 |
|-----|---------------------------------|
| P10 | Motor tachometer right TD-TMR 1 |
| P11 | Motor tachometer right TD-TMR 2 |
| P15 | Motor tachometer left TD-TML 1  |
| P16 | Motor tachometer left TD-TML 2  |
| P17 | Move sensor TD-MOVE 1           |
| P18 | Move sensor TD-MOVE 2           |
| P19 | GND                             |

## 3.2.12 Move Sensor 1.820.770.81 (GRP20/ELM11)

---

### Function:

- Scanning and transmission of the speed and transport direction (actual value) of the tape to the TAPE DECK COUNTER TIMER 1.820.823 (GRP20/EL44) in the form of two square-wave TTL signals with 90° phase shift.

### Circuit description:

The tachometer disc is rigidly coupled to the right-hand guide roller. The tachometer disc (2x 80 impulses/revolution) rotates between a dual light barrier DLQ1. The currents of the phototransistors are taken via the base circuits (Q1, Q2) to the load resistors R5, R12. Because the collector currents can vary extremely, the difference between the signal and its mean value is amplified by the subsequent opamp (IC2). In order to guarantee the function of the circuit when the tape stands still, the working range for forming the mean value is slightly narrowed (by R1, R8) relative to the signal range. Any oscillation tendency of the circuit is suppressed by regenerative feedback on the positive input of the opamp R2/R9. The output signals are converted to TTL signals (TD-MOVE1, TD-MOVE-2) by IC2 (dual differential line receiver with Schmitt trigger characteristic) and transmitted to the TAPE DECK COUNTER TIMER 1.820.823 (GRP20/EL44).

In PLAY mode the following frequencies result on the scanner:

|         |                   |
|---------|-------------------|
| A820:   | TD-MOVE 1/2 (TTL) |
| 7.5 ips | 128 Hz            |
| 15 ips  | 256 Hz            |
| 30 ips  | 512 Hz            |

### 3.2.13 Motor Tacho 1.820.771.82 GRP 36 (left) GRP 37 (right)

**Function:**

- Scanning and transmission of the rotational speed and direction of the spooling motor to the TAPE DECK COUNTER TIMER 1.820.823 (GRP20/EL44) in the form of two square wave TTL signals with 90° phase shift.

**Circuit description:** The tacho disc is rigidly coupled to the spooling motor shaft. The tacho disc (2 x 128 impulses/revolution) rotates between a dual light barrier DLQ1. The currents of the phototransistors are taken via the base circuits (Q1, Q2) to the load resistors R2, R4. Because the collector currents can vary extremely, the difference between the signal and its mean value is amplified by the subsequent opamp (IC2). In order to guarantee the function of the circuit when the motor stands still, the working range for forming the mean value is slightly narrowed (by R8, R10) relative to the signal range. Any oscillation tendency of the circuit is suppressed by regenerative feedback on the positive input of the opamp R7/R11. The output signals are converted to TTL signals (TD-TTL/R1, TD-TTL/R2) by IC2 (dual differential line receivers with Schmitt trigger characteristic) and transmitted to the TAPE DECK COUNTER TIMER 1.820.823 (GRP20/EL44).

### 3.2.14 Opto Sensor

1.820.793.82

**Function:**

- Detecting the presence of a tape and signalling to the TAPEDECK PERIPHERY CONTROLLER 1.820.762 (GRP20/ELM43) with the TTL signal TD-TRSP.  
Tape leader detection that is insensitive to extraneous light

**Circuit description:**

**Transmitter:** The comparator IC 1/1 generates the clock frequency of approx. 36 kHz which is taken via the emitter follower Q1 to the control input of IC3. The latter is a voltage regulator operating as a constant current source which supplies the clocked current for the two LEDs DL2 and DL3.

**Receiver:** Due to its variable stray capacitance, the phototransistor Q1 is connected in parallel to the much larger C of a series resonant circuit that is tuned to the clock frequency. This results in a selective series current that supplies the emitter of Q2. Additional filtering is performed in the collector by a parallel circuit. Other light frequencies, e.g. 100 Hz mains, are eliminated by the filter, and the DC voltage component produced by the ambient light is separated by C5 so that only the clocked light signal is effective. The "beta weak" dark range of the phototransistor is avoided by directly illuminating the QP1 with DL1. The "bias light" is adjusted with R22.

The stage comprising IC 2/2, DI, Q3 functions as an amplifier, limiter, and rectifier. In the non-limited amplitude range the gain is determined by the resistors R10, R11, and R12, R13. The gain can be adjusted with R13. If Q3 is conductive, C8 charges. This charging is drift-free and only dependent on the signal amplitude.

The stage IC2/1 functions as a Schmitt trigger that changes state when the voltage on C8 exceeds the threshold value. In this case also the outputs of IC2/1 and IC2/2 change to LOW, thus indicating the presence of a leader or "no tape".

## 4. Audio

|       |  |    |
|-------|--|----|
| 4.1   | Calibration.....   | 1  |
| 4.1.1 | Introduction .....   | 1  |
| 4.1.2 | Level Definitions .....  | 2  |
| 4.1.3 | Equalizations .....  | 3  |
| 4.1.4 | Magnetic Reference Flux, Standard Calibration Data.....                              | 3  |
| 4.1.5 | Calibration Tapes.....   | 4  |
| 4.1.6 | Preparatory Steps.....   | 7  |
| 4.1.7 | Reading Out the Programmed Value .....   | 9  |
| 4.2   | Manual Reproduce Adjustments.....  | 13 |
| 4.2.1 | Preparatory Steps.....   | 13 |
| 4.2.2 | Reproduce Level Adjustment.....  | 14 |
| 4.2.3 | Azimuth Alignment of the Reproduce Head .....  | 15 |
| 4.2.4 | Reproduce Frequency Response Alignment .....   | 16 |
| 4.2.5 | Alignments for other Tape Speeds.....  | 19 |
| 4.3   | Manual Record Adjustments .....  | 20 |
| 4.3.1 | Preparatory Steps.....   | 20 |
| 4.3.2 | Rec Level Prealignment.....  | 21 |
| 4.3.3 | Azimuth Alignment of the Record Head.....  | 22 |
| 4.3.4 | Bias Adjustment .....  | 23 |
| 4.3.5 | Record Level Adjustment .....  | 25 |
| 4.3.6 | Record Frequency Response Alignment.....   | 26 |
| 4.3.7 | Cross Talk Adjustment .....  | 29 |
| 4.4   | Manual Sync Reproduction Adjustments.....  | 30 |
| 4.5   | Automatic Audio and Dolby Adjustments.....   | 32 |
| 4.5.1 | Automatic Reproduce Adjustments.....   | 32 |
| 4.5.2 | Automatic Sync Reproduction Adjustments.....   | 35 |
| 4.5.3 | Automatic Record Adjustments .....   | 36 |
| 4.5.4 | Fully Automatic Record Adjustments "AUTOREC ALIGN" .....                             | 40 |
| 4.5.5 | A820 MCH Dolby/Telcom Alignment Instructions .....                                   | 41 |
| 4.6   | Time Code Recording.....   | 49 |
| 4.6.1 | Installation.....  | 49 |
| 4.6.2 | Time Code Channel Alignment.....   | 49 |
| 4.6.3 | Adjustment of Time Code Output Level .....   | 50 |
| 4.6.4 | Adjustment of Time Code Reproduce Level.....   | 50 |
| 4.6.5 | Adjustment of Time Code Record Level.....  | 51 |
| 4.6.6 | Alignment of Stray Pick-Up Interference on Time Code Read<br>Unit 1.820.821.00 ..... | 51 |
| 4.7   | External Storage of the Audio Parameters.....  | 53 |
| 4.7.1 | Storing the Parameters on Tape (SAVE) .....  | 53 |
| 4.7.2 | Comparing the Data on Tape (VERIFY) .....  | 54 |
| 4.7.3 | Loading the Data from Tape (LOAD).....   | 56 |
| 4.8   | Programming the Operating Parameters .....   | 58 |
| 4.8.1 | Program Switches and Jumper Line Amplif. Transformerl. ....                          | 58 |
| 4.8.2 | Jumper Reproduce Amplifier 1.820.710.....  | 59 |
| 4.8.3 | Program Switches and Jumpers Panel.....  | 60 |
| 4.8.4 | Adjustments on Generator Unit PCB 1.820.725 .....                                    | 61 |
| 4.8.5 | Generator Unit 1.820.825.00.....   | 63 |
| 4.8.6 | Adjustments on Communication Controller 1.820.718.....                               | 67 |
| 4.8.7 | Jumper Setting Ext. NRS Controller 1.820.816 .....                                   | 68 |
| 4.8.8 | Jumper Setting Audio Rack .....  | 69 |



|        |   |    |
|--------|---|----|
| 4.9    | Reproduce Preamplifier 8CH 1.820.808.XX.....              | 70 |
| 4.9.1  | Record Amplifier HX PRO 1.820.811.81 .....                | 70 |
| 4.9.2  | HF Driver 1.820.813.XX.....                               | 71 |
| 4.9.3  | Meter-Panel.....  | 72 |
| 4.9.4  | Bargraph Module 1.820.736.....                            | 72 |
| 4.9.5  | Keyboards 1.820.708/817.....                              | 72 |
| 4.9.6  | Keyboard Driver 1.820.709.....                            | 72 |
| 4.9.7  | Audio Alignment Keyboard 1.820.707 .....                  | 73 |
| 4.10   | Time Code Line Amplifier 1.820.820.00 .....               | 74 |
| 4.10.1 | Time Code Read Unit 1.820.821.00.....                     | 74 |
| 4.10.2 | Generator Unit MCH 1.820.725.00.....                      | 74 |
| 4.10.3 | Generator Unit MCH 1.820.825.00 + 1.820.826.00.....       | 75 |
| 4.10.4 | Switching & Metering Unit 1.820.716.00.....               | 76 |
| 4.10.5 | Internal NRS Controller 1.820.815.00 + 1.820.867.00 ..... | 76 |
| 4.10.6 | Internal Controller SR/A 1.820.824.00 .....               | 77 |

---

## 4 Audio

---

### 4.1 Calibration

---

The audio parameters are copied from RAM and loaded into the registers of the audio amplifiers each time the recorder is switched on, after a microprocessor reset, or when changing the tape speed, the tape type or the equalization.

When new parameters are entered via the alignment section or the parameter backup function, the old parameters stored in the RAM and in the registers of the audio amplifiers are overwritten with the new data.

If the parameters in the RAM are lost, the standard parameters are automatically loaded from the PROM.

#### 4.1.1 Introduction

---

##### General

It is assumed that all mechanical adjustments of the recorder to be calibrated are correct (especially with respect to tape tensions and tape guidance).

The soundheads and the tape guidance elements should be cleaned and demagnetized before the recorder is calibrated.

The calibration steps should always be performed in the following sequence:

##### Reproduce Adjustments

With preferred studio tape speed:

- Level
- Azimuth alignment of the reproduce head (note 1)
- Frequency response (note 2)

For all other tape speeds:

- Level
- Frequency response (note 2)

**Note 1:** Depending on the type of reference tape used, minor deviations between the different speeds can occur. In this case the final azimuth alignment should be made with the preferred studio speed.

**Note 2:** Studio tape recorders are usually calibrated with full-track calibration tapes. Fringing effects can cause frequency response errors at low frequencies in stereo, two-channel, and multichannel recorders. It is, therefore, recommended to adjust the reproduce low frequency response whilst in the record mode if no calibration tapes with correct guard track width are available.

##### Record Adjustments

With preferred studio tape speed:

- Record level prealignment
- Azimuth alignment of the record head gap (bias parameters set to approximately the same values for all channels!)
- Bias
- Record level
- Frequency response

For all other tape speeds:

- Record level prealignment
- Bias
- Record level
- Frequency response

Sync Reproduction      All tape speeds:

- Level
- Frequency response

## 4.1.2 Level Definitions

**Voltage level 0 dBm (=0.775 V):**      Is deduced from the power level of 1 mW in a load of any value. If applied to a resistance of 600 Ω, a voltage drop of 0.775 V occurs.

**0 dBu (=0.775 V):**      Corresponds to 0.775 V without referring to any load resistance.

**Line level:**

- The level available at the output of a tape recorder when reproducing a recording with reference flux density, or
- The level producing a recording with reference flux density when fed in the input of a tape recorder.

**Voltage "Bezugspegel":**      CCIR designation for line level. This level produces an indication of 0 dB on a quasi peak reading meter.

**Standard Reference Level (Operating Level):**      Designation common in USA for the reference flux density of 250 nWb/m for high output tapes or 200 nWb/m for standard tapes. This level produces an indication of 0 VU on a VU-meter.

**Peak Level:**      Designation common in USA for a level that is as a rule 8 to 10 dB greater than operating level. To simplify matters, a "peak level" of +6 dB (twice the voltage level) relative to operating level is used for tape recorder alignment.

**NAB alignment:**

| Definition      | Line level [dBu] (Level range function No.010) | Metering in pos. "VU", see function No. 053 [VU] |
|-----------------|--|--|
| OPERATING LEVEL | + 4  | 0  |
| "PEAK LEVEL"    | +10  | +6   |

Reproduce reference level = operating level

**CCIR/IEC alignment:**

| Definition    | Line level [dBu] (Level range function No.009) | Metering in pos. "PEAK", see function No. 053 [dB] |
|---------------|--|--|
| "BEZUGSPEGEL" | + 6  | 0  |

### 4.1.3 Equalizations

Equalization networks have been built into the reproduce paths for correcting the frequency response.

The attack points are referred to as transition frequencies or transition time constants respectively ( $1/2\pi f$ ) and have been standardized by various organizations (IEC, NAB, AES, CCIR).

| TAPE SPEED            | TRANSITION FREQUENCIES, LOW AND HIGH<br>(TRANSITION TIME CONSTANTS) |   |   |
|-----------------------|---|---|---|
|                       | IEC-1968  | NAB-1965  | NAB-1975                                  |
| 19,05 cm/s<br>7,5 ips | 0 Hz; 2240 Hz<br>( $\infty$ ; 70 $\mu$ s)                           | 50 Hz; 3150 Hz<br>(3180 $\mu$ s; 50 $\mu$ s)            | 0 Hz; 3150 Hz<br>( $\infty$ ; 50 $\mu$ s) |
| 38,10 cm/s<br>15 ips  | 0 Hz; 4500 Hz<br>( $\infty$ ; 35 $\mu$ s)                           | 50 Hz; 3150 Hz<br>(3180 $\mu$ s; 50 $\mu$ s)            | -<br>(-)                                  |
| 76,20 cm/s<br>30 ips  | 0 Hz; 9000 Hz<br>( $\infty$ ; 17.5 $\mu$ s)                         | AES 1971<br>0 Hz; 9000 Hz<br>( $\infty$ ; 17.5 $\mu$ s) | -<br>(-)                                  |

### 4.1.4 Magnetic Reference Flux, Standard Calibration Data

A tape recording made with reference level should produce line level on the output in play mode.

The following standard settings are made at the factory:

- NAB settings:**
- Line voltage: 220 V
  - Line frequency: 50 Hz
  - Line level: +4 dBu
  - Indication of VU-meter at line level: 0 VU
  - Load impedance: 10 k $\Omega$
  - Tape type: Ampex 456 GRAND MASTER
  - Tape flux at line level: 7.5 ips 250 nWb/m  
15 ips 250 nWb/m  
30 ips 250 nWb/m

- CCIR settings:**
- Line voltage: 220 V
  - Line frequency: 50 Hz
  - Line level: +6 dBu
  - Indication of peak meter at line level: 0 dB
  - Load impedance: 10 k $\Omega$
  - Tape type: Agfa PEM 468
  - Tape flux at line level: 7.5 ips 510 nWb/m  
15 ips 510 nWb/m  
30 ips 510 nWb/m

The recorders are calibrated for one of the two types of equalization only until further notice.

#### 4.1.5 Calibration Tapes

---

Calibration tapes are used for aligning the reproduce path of tape recorders. Such tapes are magnetized across their full width. A separate tape is used for each speed.

**Important** To prevent unintentional erasure of valuable tapes, all channels should be switched to SAFE while adjustments are being made! On recorders without a SAFE button, MASTER SAFE is to be switched on.  
Calibration tapes are divided into the following test sections:

**Reference Level Section** (Reference flux = 320 nWb/m for 7 1/2, 15, and 30 ips, 257 nWb/m for 3 3/4 ips) should produce line level on the output of the tape recorder.  
The output level is to be adjusted to the required line level during the reproduction of this test section which has a length of approximately 60 to 180 seconds.  
NAB calibration tapes with a reference flux of 200 nWb/m should produce an output level of -4 dB relative to 320 nWb/m; CCIR calibration tapes with a reference flux of 320 nWb/m produce on stereo recorders an output level of -4 dB relative to line level and 510 nWb/m.

**Level matching:** If the tape deck is to be calibrated with a different reference level, i.e. one that is generally higher, the reference fluxivity difference is calculated by applying the following formula:

$$20 \log_{10} * \frac{\text{flux of reference tape}}{\text{desired reference flux}} = \text{Difference [dB]}$$

**Example:** Reference tape = 200 nWb/m  
Desired reference fluxivity, i.e. for a tape with a high dynamic range = 510 nWb/m.

$$\text{Difference} = 20 \log_{10} x \frac{200 \text{ nWb/m}}{510 \text{ nWb/m}} = -8 \text{ dB}$$

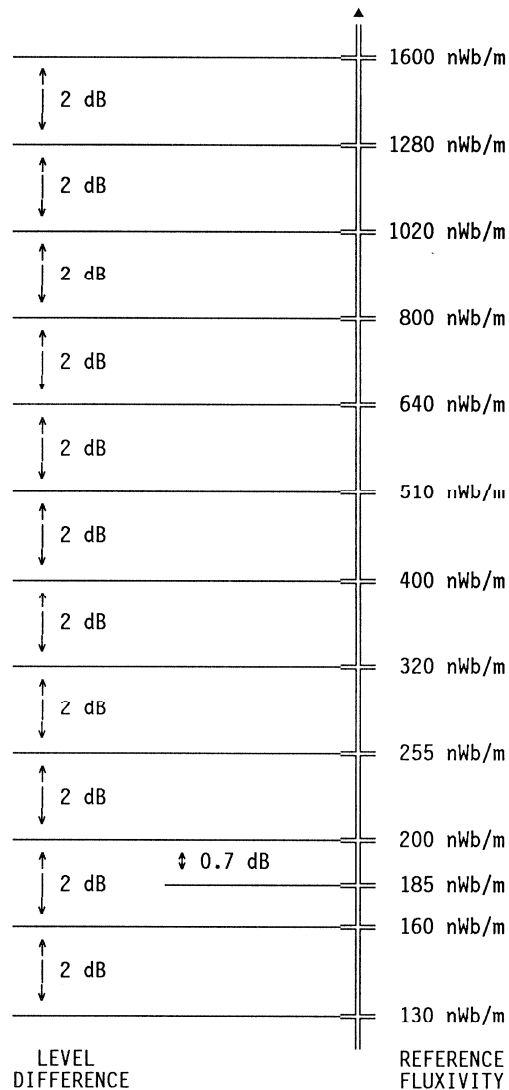

**Azimuth Alignment Section**

For adjusting the vertical ("azimuth") alignment of the reproduce head gap. This test section is divided into a short segment containing the reference frequency (for coarse adjustment) and a long segment with 10 kHz for fine adjustment. NAB calibration tapes may be formatted differently. The level of this section is normally 10 dB below the line level.

The head is aligned to maximum output voltage with the azimuth adjustment screw. Align to minimum phase difference between channels with the aid of a 2-channel oscilloscope or an AF millivoltmeter with two inputs and summation.

**Important:**

If significant changes in the reproduce head azimuth are made, other voltage maxima with lower levels will occur!

With correct equalization of the reproduce amplifier, the reproduce level is identical for recordings that are made with reference frequency and with 10 (8; 16) kHz, at a level 10 dB (20 dB) below reference level.

**Frequency Response  
Section**

For determining and adjusting the reproduce response at specific frequencies. NAB calibration tapes exist that produce frequencies other than those listed in the following table.

| REFERENCE TAPE  | CCIR  |    |    | NAB   |    |             |
|---|---|----|----|---|----|-------------|
| TAPE SPEED<br>[cm/s]; [ips]   | 19  | 38 | 76 | 7,5   | 15 | 30<br>(AES) |
| REF. LEV. SECTION:<br>REF. FREQUENCY<br>REF. FLUX DENSITY             | 1 kHz<br>320 nWb/m  |    |    | 1 kHz (700 Hz)<br>200 nWb/m   |    |             |
| AZIMUTH ALIGNMENT<br>SECTION:<br>(-10 dB)                             | 1 kHz<br>10 kHz   |    |    | 500 (700) Hz<br>8 kHz<br>16 kHz   |    |             |
| FREQUENCY<br>RESPONSE<br>SECTION:<br>(CCIR: -20 dB)<br>(NAB : -10 dB) | 1 kHz<br>31,5 Hz<br>40<br>63<br>125<br>250<br>500<br>1 kHz<br>2<br>4<br>6,3<br>8<br>10<br>12,5<br>14<br>16<br>18<br>1 kHz |    |    | 31,5 Hz<br>63<br>125<br>250<br>500<br>1 kHz<br>2<br>4<br>8<br>10<br>12,5<br>16<br>20<br>1 kHz |    |             |

## 4.1.6 Preparatory Steps

Before the calibration is started, the parameters of the recorder must be programmed for the desired application. Also refer to Section 2.6, "SOFT KEYS".

Line level:

Set required level:

| OPERATING LEVEL<br>(NAB) | "BEZUGSPEGEL"<br>(CCIR) | FUNCTION No. |
|--------------------------|-------------------------|--------------|
| 0 dBu                    | 6 dBu                   | 009          |
| 4 dBu                    | 10 dBu                  | 010          |
| 8 dBu                    | 14 dBu                  | 011          |
| 10 dBu                   | 16 dBu                  | 012          |

These four functions (009 to 012) are available to match the tape recorder to the line level used in the studio.

Operating level as well as "Bezugspegel" is indicated on the service display. The first of the two level indications is referred to NAB standards, the second to CCIR. In case that any of the four gradations are adequate, the value should be selected that comes closest to the studio level, and the internal record and reproduce levels should be adjusted in such a way that the recorder operates with the desired bias.

**Examples:** Function 011, CCIR equalization, "Bezugspegel" = 14 dBu, level meter set to PPM characteristic (see function No. 053), PPM reading at "Bezugspegel" 0 dB.  
Reading of service display when recorder ready:

L RANGE: 8/14 dBu

Function 010, NAB equalization, operating level = 4 dBu, level meter set to VU characteristic (see function No. 053), VU-meter reading at operating level 0 VU.  
Reading of the service display when recorder ready:

L RANGE: 4/10 dBu

Function 012, CCIR equalization, line level 15 dBu, selected "Bezugspegel" = 16 dBm (record and reproduce levels internally adjusted to match the required line level), level meter set to PPM characteristic (see function No. 053), PPM reading at "Bezugspegel" 0 dB.

Reading of service display when recorder ready:

L RANGE: 10/16 dBu



### Checking the output level and the VU-meter reading

- Connect AF generator to a line input and feed 1 kHz with line level.
- Connect AF millivoltmeter to the corresponding line output and load the output with 10 k $\Omega$  (standard) or with 200  $\Omega$  (minimum).
- Switch the recorder on and press ALL INPUT.
- Adjust output level to line level with the aid of the trimmer potentiometer on every LINE AMPLIFIER, accessible from the front.

### Check VU-meter reading:

- VU characteristic: line level should give a reading of 0 VU (NAB).
- PPM characteristic: line level should give a reading of -6 dB (NAB) or 0 dB (CCIR).

### Adjusting the CMRR of the line inputs:

(CMRR = common mode rejection ratio)

This adjustment is required only after repairs on the LINE AMPLIFIER TRANSFORMERLESS 1.820.715.00 .

- Interconnect the two lines A and B at the line input of the concerned channel. Connect AF generator to both lines and feed in 1 kHz or 20 kHz, resp., with line level, relative to ground.
- Connect AF millivoltmeter to the line output of the concerned channel.
- Switch recorder to INPUT (see above).
- Adjust AF generator to 1 kHz, adjust minimum output level with trimmer potentiometer R78 ( $\leq -40$  dB, typ. -50 dB).
- Adjust AF generator to 20 kHz, adjust minimum output level by means of trimmer capacitor C18 ( $\leq -40$  dB, typ. -50 dB).
- Because of the minor mutual action these adjustments should be repeated at both frequencies.

### Generator setting

(see Section 4.8.4)

### CCIR/NAB equalizations

Select the desired equalization on the function and programming key field: CCIR or NAB (press changeover button together with SET ENABLE).

### Tape type A/B

Set tape type selector to the desired position (press together with SET ENABLE).

**Note:** Repeat the reproduce and record adjustments step by step for the second tape formulation and for each tape speed, as well as for 8-track, 16-track, and 24-track headblocks.

### Adjusting the Communication Controller PCB (for external storage of the audio parameters)

(see Section 4.8.5)

### 4.1.7 Reading Out the Programmed Value

The gain range of the individual amplifiers can be varied in 255 steps between 0 and the maximum (corresponds to 256 discrete values). These 256 values are equivalent to 256 settings of a potentiometer between its two limit positions. The programmed value is indicated on the service display. The hexadecimal format has been chosen to conserve space (00 for 0 and FF for 255).

Examples of hexadecimal numbers:

|             |   |   |   |   |   |   |   |   |   |   |    |    |    |    |    |    |
|-------------|---|---|---|---|---|---|---|---|---|---|----|----|----|----|----|----|
| DECIMAL     | 0 | 1 | 2 | 3 | 4 | 5 | 6 | 7 | 8 | 9 | 10 | 11 | 12 | 13 | 14 | 15 |
| HEXADECIMAL | 0 | 1 | 2 | 3 | 4 | 5 | 6 | 7 | 8 | 9 | A  | B  | C  | D  | E  | F  |

| HEXADECIMAL | DECIMAL | % of FF resp. 255 |
|-------------|---------|-------------------|
| 1A          | 26      | 10                |
| 33          | 51      | 20                |
| 4D          | 77      | 30                |
| 66          | 102     | 40                |
| 80          | 128     | 50                |
| 99          | 153     | 60                |
| B3          | 179     | 70                |
| CC          | 204     | 80                |
| E6          | 230     | 90                |

**Important** The displayed hexadecimal values should indicate to the user the range in which the corresponding amplifier is operating. No voltages can be extrapolated from these numbers!

**Modifying the parameters** Pressing the PARAM↑ or PARAM↓ keys has the same effect as rotating a potentiometer clockwise or counterclockwise. In contrast to the adjustments by means of potentiometers it is possible to accurately reproduce the values stored in RAM at any time.

**Storing the parameters** When the desired value has been attained (for example line level 10 dBu = 2.5 V) it can be stored in RAM by pressing the STORE key. For comparison purposes the hexadecimal amplifier settings can be recorded in a table. See next page.

# STUDER A820 MCH

**Model:** A820 24 Channel  
**Serial No.:** .....  
**Head No.:** .....

**Recorder adjusted for:**

**Input level:** .....  
**Output level:** .....  
**Load impedance:** .....  
**Tape type:** .....  
**Flux density:** .....  
**Equalization:** .....

**\*\* REPRO \*\***

| CHANNEL |     | AUDIO PARAMETER |    |     |             |    |     |             |    |  |
|---------|-----|-----------------|----|-----|-------------|----|-----|-------------|----|--|
|         |     | L E V E L       |    |     | T R E B L E |    |     | B A S S     |    |  |
|         |     | SPEED [IPS]     |    |     | SPEED [IPS] |    |     | SPEED [IPS] |    |  |
| NUMBER  | 7.5 | 15              | 30 | 7.5 | 15          | 30 | 7.5 | 15          | 30 |  |
| 1       | ..  | ..              | .. | ..  | ..          | .. | ..  | ..          | .. |  |
| 2       | ..  | ..              | .. | ..  | ..          | .. | ..  | ..          | .. |  |
| 3       | ..  | ..              | .. | ..  | ..          | .. | ..  | ..          | .. |  |
| 4       | ..  | ..              | .. | ..  | ..          | .. | ..  | ..          | .. |  |
| 5       | ..  | ..              | .. | ..  | ..          | .. | ..  | ..          | .. |  |
| 6       | ..  | ..              | .. | ..  | ..          | .. | ..  | ..          | .. |  |
| 7       | ..  | ..              | .. | ..  | ..          | .. | ..  | ..          | .. |  |
| 8       | ..  | ..              | .. | ..  | ..          | .. | ..  | ..          | .. |  |
| 9       | ..  | ..              | .. | ..  | ..          | .. | ..  | ..          | .. |  |
| 10      | ..  | ..              | .. | ..  | ..          | .. | ..  | ..          | .. |  |
| 11      | ..  | ..              | .. | ..  | ..          | .. | ..  | ..          | .. |  |
| 12      | ..  | ..              | .. | ..  | ..          | .. | ..  | ..          | .. |  |
| 13      | ..  | ..              | .. | ..  | ..          | .. | ..  | ..          | .. |  |
| 14      | ..  | ..              | .. | ..  | ..          | .. | ..  | ..          | .. |  |
| 15      | ..  | ..              | .. | ..  | ..          | .. | ..  | ..          | .. |  |
| 16      | ..  | ..              | .. | ..  | ..          | .. | ..  | ..          | .. |  |
| 17      | ..  | ..              | .. | ..  | ..          | .. | ..  | ..          | .. |  |
| 18      | ..  | ..              | .. | ..  | ..          | .. | ..  | ..          | .. |  |
| 19      | ..  | ..              | .. | ..  | ..          | .. | ..  | ..          | .. |  |
| 20      | ..  | ..              | .. | ..  | ..          | .. | ..  | ..          | .. |  |
| 21      | ..  | ..              | .. | ..  | ..          | .. | ..  | ..          | .. |  |
| 22      | ..  | ..              | .. | ..  | ..          | .. | ..  | ..          | .. |  |
| 23      | ..  | ..              | .. | ..  | ..          | .. | ..  | ..          | .. |  |
| 24      | ..  | ..              | .. | ..  | ..          | .. | ..  | ..          | .. |  |

**Equalization Parameter:**  
CCIR/NAB

REPROD. [7.5 IPS]= .../....      [15 IPS] = .../....      [30 IPS] = .../....  
 RECORD. [7.5 IPS]= .../....      [15 IPS] = .../....      [30 IPS] = .../....  
 SYNCHR. [7.5 IPS]= .../....      [15 IPS] = .../....      [30 IPS] = .../....

\*\* RECORD \*\*

| CHANNEL<br>NUMBER | AUDIO PARAMETER |    |    |             |    |    |             |    |    |
|-------------------|-----------------|----|----|-------------|----|----|-------------|----|----|
|                   | L E V E L       |    |    | T R E B L E |    |    | B A S S     |    |    |
|                   | SPEED [IPS]     |    |    | SPEED [IPS] |    |    | SPEED [IPS] |    |    |
|                   | 7.5             | 15 | 30 | 7.5         | 15 | 30 | 7.5         | 15 | 30 |
| 1                 | ..              | .. | .. | ..          | .. | .. | ..          | .. | .. |
| 2                 | ..              | .. | .. | ..          | .. | .. | ..          | .. | .. |
| 3                 | ..              | .. | .. | ..          | .. | .. | ..          | .. | .. |
| 4                 | ..              | .. | .. | ..          | .. | .. | ..          | .. | .. |
| 5                 | ..              | .. | .. | ..          | .. | .. | ..          | .. | .. |
| 6                 | ..              | .. | .. | ..          | .. | .. | ..          | .. | .. |
| 7                 | ..              | .. | .. | ..          | .. | .. | ..          | .. | .. |
| 8                 | ..              | .. | .. | ..          | .. | .. | ..          | .. | .. |
| 9                 | ..              | .. | .. | ..          | .. | .. | ..          | .. | .. |
| 10                | ..              | .. | .. | ..          | .. | .. | ..          | .. | .. |
| 11                | ..              | .. | .. | ..          | .. | .. | ..          | .. | .. |
| 12                | ..              | .. | .. | ..          | .. | .. | ..          | .. | .. |
| 13                | ..              | .. | .. | ..          | .. | .. | ..          | .. | .. |
| 14                | ..              | .. | .. | ..          | .. | .. | ..          | .. | .. |
| 15                | ..              | .. | .. | ..          | .. | .. | ..          | .. | .. |
| 16                | ..              | .. | .. | ..          | .. | .. | ..          | .. | .. |
| 17                | ..              | .. | .. | ..          | .. | .. | ..          | .. | .. |
| 18                | ..              | .. | .. | ..          | .. | .. | ..          | .. | .. |
| 19                | ..              | .. | .. | ..          | .. | .. | ..          | .. | .. |
| 20                | ..              | .. | .. | ..          | .. | .. | ..          | .. | .. |
| 21                | ..              | .. | .. | ..          | .. | .. | ..          | .. | .. |
| 22                | ..              | .. | .. | ..          | .. | .. | ..          | .. | .. |
| 23                | ..              | .. | .. | ..          | .. | .. | ..          | .. | .. |
| 24                | ..              | .. | .. | ..          | .. | .. | ..          | .. | .. |

Erase Parameter:

|              |              |
|--------------|--------------|
| CH 1 = ....  | CH 13 = .... |
| CH 2 = ....  | CH 14 = .... |
| CH 3 = ....  | CH 15 = .... |
| CH 4 = ....  | CH 16 = .... |
| CH 5 = ....  | CH 17 = .... |
| CH 6 = ....  | CH 18 = .... |
| CH 7 = ....  | CH 19 = .... |
| CH 8 = ....  | CH 20 = .... |
| CH 9 = ....  | CH 21 = .... |
| CH 10 = .... | CH 22 = .... |
| CH 11 = .... | CH 23 = .... |
| CH 12 = .... | CH 24 = .... |

\*\* SYNCH \*\*

| CHANNEL<br>NUMBER | AUDIO PARAMETER |    |    |             |    |    |             |    |    |
|-------------------|-----------------|----|----|-------------|----|----|-------------|----|----|
|                   | L E V E L       |    |    | T R E B L E |    |    | B A S S     |    |    |
|                   | SPEED [IPS]     |    |    | SPEED [IPS] |    |    | SPEED [IPS] |    |    |
|                   | 7.5             | 15 | 30 | 7.5         | 15 | 30 | 7.5         | 15 | 30 |
| 1                 | ..              | .. | .. | ..          | .. | .. | ..          | .. | .. |
| 2                 | ..              | .. | .. | ..          | .. | .. | ..          | .. | .. |
| 3                 | ..              | .. | .. | ..          | .. | .. | ..          | .. | .. |
| 4                 | ..              | .. | .. | ..          | .. | .. | ..          | .. | .. |
| 5                 | ..              | .. | .. | ..          | .. | .. | ..          | .. | .. |
| 6                 | ..              | .. | .. | ..          | .. | .. | ..          | .. | .. |
| 7                 | ..              | .. | .. | ..          | .. | .. | ..          | .. | .. |
| 8                 | ..              | .. | .. | ..          | .. | .. | ..          | .. | .. |
| 9                 | ..              | .. | .. | ..          | .. | .. | ..          | .. | .. |
| 10                | ..              | .. | .. | ..          | .. | .. | ..          | .. | .. |
| 11                | ..              | .. | .. | ..          | .. | .. | ..          | .. | .. |
| 12                | ..              | .. | .. | ..          | .. | .. | ..          | .. | .. |
| 13                | ..              | .. | .. | ..          | .. | .. | ..          | .. | .. |
| 14                | ..              | .. | .. | ..          | .. | .. | ..          | .. | .. |
| 15                | ..              | .. | .. | ..          | .. | .. | ..          | .. | .. |
| 16                | ..              | .. | .. | ..          | .. | .. | ..          | .. | .. |
| 17                | ..              | .. | .. | ..          | .. | .. | ..          | .. | .. |
| 18                | ..              | .. | .. | ..          | .. | .. | ..          | .. | .. |
| 19                | ..              | .. | .. | ..          | .. | .. | ..          | .. | .. |
| 20                | ..              | .. | .. | ..          | .. | .. | ..          | .. | .. |
| 21                | ..              | .. | .. | ..          | .. | .. | ..          | .. | .. |
| 22                | ..              | .. | .. | ..          | .. | .. | ..          | .. | .. |
| 23                | ..              | .. | .. | ..          | .. | .. | ..          | .. | .. |
| 24                | ..              | .. | .. | ..          | .. | .. | ..          | .. | .. |

Test engineer: .....

Date: .....

## 4.2 Manual Reproduce Adjustments

### 4.2.1 Preparatory Steps

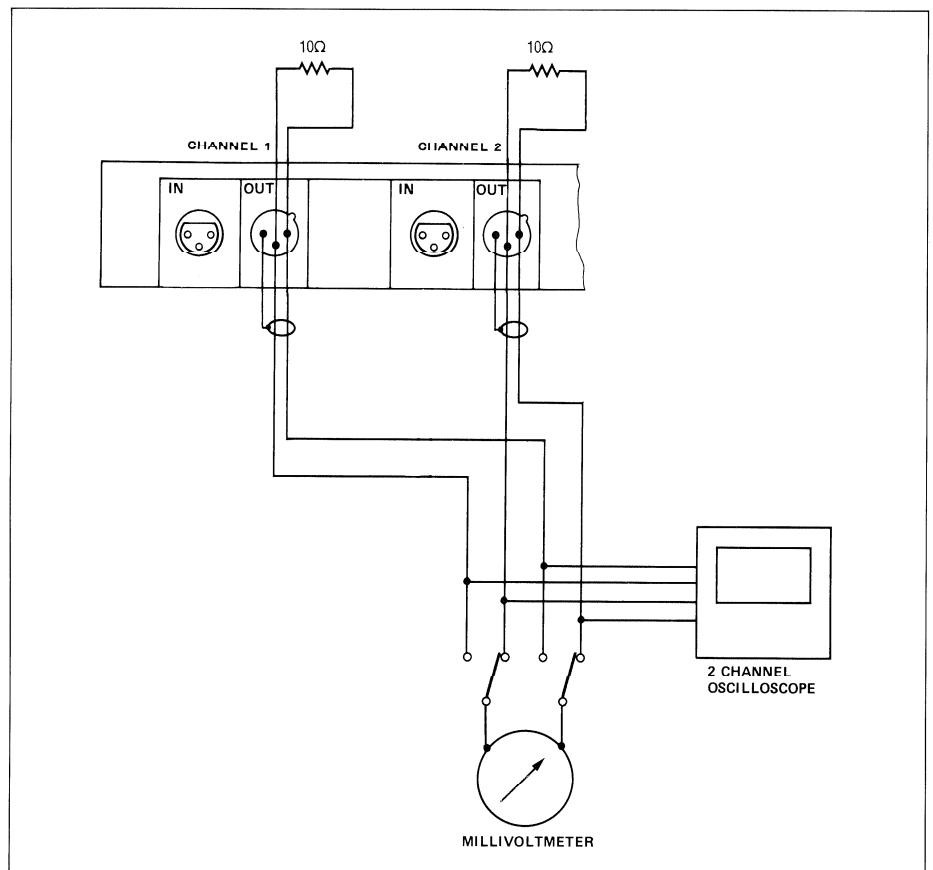
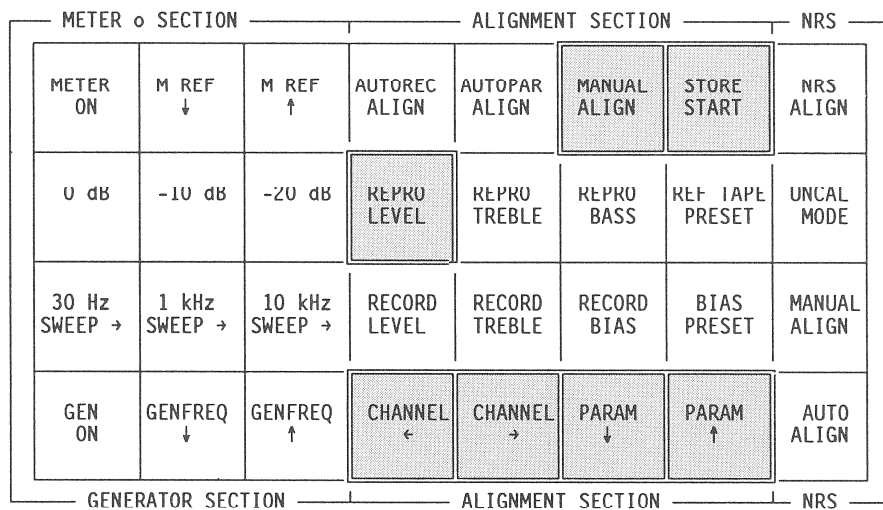
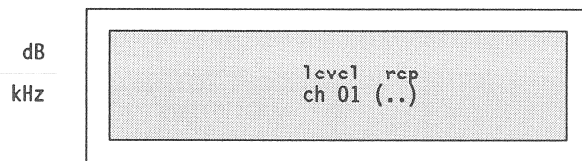

Fig. 4.2.1

- Connect AF millivoltmeter to line output channel 1. Load the line outputs for all measurements with  $10\text{ k}\Omega$ .
- Make sure that the preparatory adjustments in Section 4.1.6 have been made.

### 4.2.2 Reproduce Level Adjustment

- Switch recorder ON.
- Select preferred studio tape speed.
- Press MASTER SAFE and ALL REPRO.
- Load calibration tape for the corresponding equalization and speed and spool forward to the Reference Level Section.
- Press MANUAL ALIGN and REPRO LEVEL on the audio alignment keyboard.



- Select the desired channel with the keys CHANNEL▶ and CHANNEL◀ or by pressing the REPRO key of the desired channel.
- Start recorder in PLAY mode.
- Adjust the reproduction level for the desired line level by pressing the keys PARAM↑ or PARAM↓. The LC display indicates HEX (hexadecimal) values.
- Press STORE if the level is reached.
- Repeat adjustment for all remaining channels.

### 4.2.3 Azimuth Alignment of the Reproduce Head

- Spool calibration tape forward to the Azimuth Alignment Section. The level of this section is approximately 10 dB lower than in the level tone section. Connect millivoltmeter to channel 1.
- Start recorder in PLAY mode.

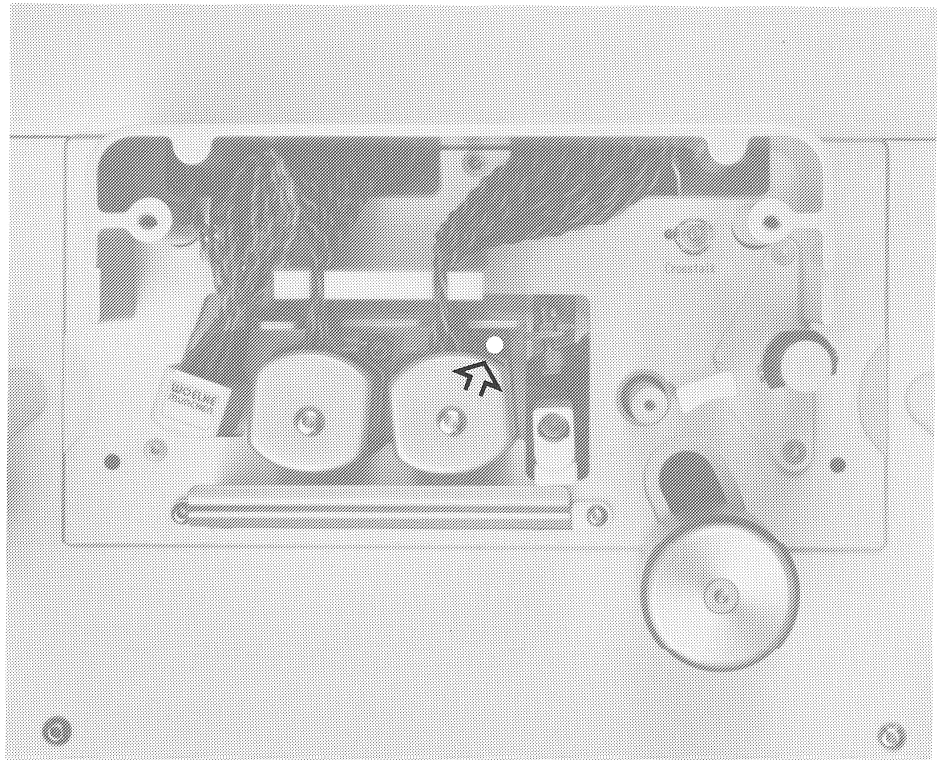

Fig. 4.2.3

#### Coarse adjustment:

- While a recording with reference frequency is played, correct the azimuth of the reproduce head until the maximum output level is attained.

#### Fine-adjustment:

- Align for optimum phase between the channels, either by connecting them, one after the other, to the inputs of a 2-channel oscilloscope while playing a recording with 8, 10 or 16 kHz, and by further correcting with the azimuth alignment screw for minimum phase difference of the line output signals (use channel 1 as reference),
- or
- by connecting them, one after the other, to the inputs of an AF millivoltmeter with summing facility while playing a recording with 8, 10, or 16 kHz, and by further correcting with the azimuth alignment screw to maximum level of the sum of both line output signals (use channel 1 as reference).

**Important:** Always align to maximum level first and then to minimum phase difference! If the inclination of the reproduce head is significantly modified, additional maxima, but with lower level, can occur. To make sure, check phase with a slightly different frequency.

#### Level check:

- Rewind reference tape to the test section "LEVEL TONE" and start recorder in reproduce mode.
- Check level of all channels and correct, if necessary.



#### 4.2.4 Reproduce Frequency Response Alignment

##### Treble Alignment:

- Spool calibration tape forward to the "FREQUENCY RESPONSE 16 kHz" test section (applies to 30 ips; 14 kHz for 15 ips, 12.5 kHz for 7 1/2 ips). The level of this test section is approximately 20 dB (CCIR) lower than in the Reference Level Section.
- Connect millivoltmeter to the line outputs.
- Press MANUAL ALIGN and REPRO TREBLE on the audio alignment keyboard.

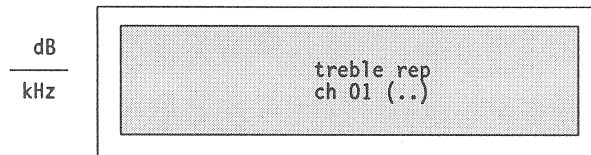

| METER SECTION     |               |                | ALIGNMENT SECTION |               |              |                 | NRS          |
|-------------------|---------------|----------------|-------------------|---------------|--------------|-----------------|--------------|
| METER ON          | M REF ↓       | M REF ↑        | AUTOREC ALIGN     | AUTOPAR ALIGN | MANUAL ALIGN | STORE START     | NRS ALIGN    |
| 0 dB              | -10 dB        | -20 dB         | REPRO LEVEL       | REPRO TREBLE  | REPRO BASS   | REF TAPE PRESET | UNCAL MODE   |
| 30 Hz SWEEP →     | 1 kHz SWEEP → | 10 kHz SWEEP → | RECORD LEVEL      | RECORD TREBLE | RECORD BIAS  | BIAS PRESET     | MANUAL ALIGN |
| GEN ON            | GENFREQ ↓     | GENFREQ ↑      | CHANNEL ←         | CHANNEL →     | PARAM ↓      | PARAM ↑         | AUTO ALIGN   |
| GENERATOR SECTION |               |                | ALIGNMENT SECTION |               |              |                 | NRS          |

- Select the desired channel with the keys CHANNEL▶ and CHANNEL◀ or by pressing the REPRO key of the desired channel.
- Start recorder in PLAY mode.
- Adjust the treble reproduction level for the desired line level by pressing the keys PARAM↑ or PARAM↓. The LC display indicates HEX (hexadecimal) values.
- Press STORE if the level is reached.
- Repeat adjustment for all remaining channels.

## Changing the reproduce standard equalization:

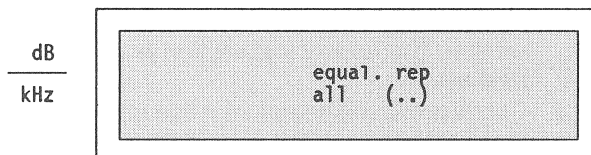

### Default values:

|         | CCIR    |       | NAB     |       |
|---------|---------|-------|---------|-------|
|         | 8/16 CH | 24 CH | 8/16 CH | 24 CH |
| 30 ips  | 26      | 2C    | 26      | 2C    |
| 15 ips  | 44      | 4F    | 61      | 69    |
| 7.5 ips | 7C      | 7C    | 69      | 69    |
| delete  | C0      | A0    | C0      | A0    |

For special situations it is possible to modify the reproduce frequency response by slightly shifting the time constant for the reproduce standard equalization.

The reproduce standard equalization time constant is set for all channels in common as follows:

- Press MANUAL ALIGN and 4 times REPRO TREBLE.
- Start recorder in PLAY mode.
- The time constant can be increased by pressing PARAM↑, i.e. the transition frequency is shifted toward lower frequencies. Press STORE after the optimum frequency response has been found.

| THEORETICAL STANDARD EQUALIZATION ADJUSTMENTS |                         |                      |
|---|-------------------------|----------------------|
| STANDARD TIME CONSTANT [μs]                   | TRANSITION FREQU. [kHz] | REPRODUCE HEX. VALUE |
| 120   | 1.326                   | E5                   |
| 90  | 1.768                   | A3                   |
| 70  | 2.273                   | 87                   |
| 50  | 3.150                   | 61                   |
| 35  | 4.547                   | 44                   |
| 17.5  | 9.094                   | 26                   |

**Bass alignment:**

- Spool the calibration tape to the "FREQUENCY RESPONSE 63 Hz" test section. The level of this section is approximately 10 dB lower than in the level tone section.
- Connect millivoltmeter to the line outputs.
- Press MANUAL ALIGN and REPRO BASS on the audio alignment keyboard.

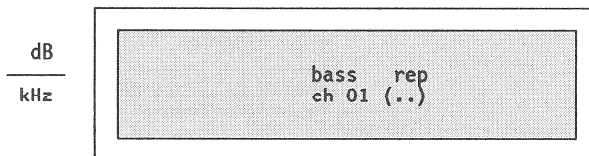

| METER SECTION     |               |                | ALIGNMENT SECTION |               |              |                 | NRS          |
|-------------------|---------------|----------------|-------------------|---------------|--------------|-----------------|--------------|
| METER ON          | M REF ↓       | M REF ↑        | AUTOREC ALIGN     | AUTOPAR ALIGN | MANUAL ALIGN | STORE START     | NRS ALIGN    |
| 0 dB              | -10 dB        | -20 dB         | REPRO LEVEL       | REPRO TREBLE  | REPRO BASS   | REF TAPE PRESET | UNCAL MODE   |
| 30 Hz SWEEP →     | 1 kHz SWEEP → | 10 kHz SWEEP → | RECORD LEVEL      | RECORD TREBLE | RECORD BIAS  | BIAS PRESET     | MANUAL ALIGN |
| GEN ON            | GENFREQ ↓     | GENFREQ ↑      | CHANNEL ←         | CHANNEL →     | PARAM ↓      | PARAM ↑         | AUTO ALIGN   |
| GENERATOR SECTION |               |                | ALIGNMENT SECTION |               |              |                 | NRS          |

- Select the desired channel with the keys CHANNEL▶ and CHANNEL◀ or by pressing the REPRO key of the desired channel.
- Start recorder in PLAY mode.
- Adjust the bass reproduction level for the desired line level by pressing the keys PARAM↑ or PARAM↓. The LC display indicates HEX (hexadecimal) values.
- Press STORE if the level is reached.
- Repeat adjustment for all remaining channels.

**Important:** If non track-compensated calibration tapes are used for the reproduce (and sync reproduce) alignment of multichannel recorders, strong fringing effects can occur at low frequencies. To ensure that a linear reproduce frequency response is attained, the reproduce (and sync reproduce) adjustment of the bass frequencies must either be repeated with tape present (after the record alignment) or, if no record adjustments are planned, a calibration tape with track compensation should be used!

## 4.2.5 Alignments for other Tape Speeds

---

The alignments for other tape speeds are basically performed in the same manner as outlined in Sections 4.2.2 through 4.2.4:

- Select desired speed
- Change over the equalization and tape type if necessary
- Mount corresponding calibration tape.

**Exceptions:** The alignment of the reproduce frequency response is made with different frequencies, depending on the tape speed:

| [ips] | ADJUSTMENT FOR        |                    |
|-------|-----------------------|--------------------|
|       | TREBLE REPRO<br>[kHz] | BASS REPRO<br>[Hz] |
| 7.5   | 12.5                  | 63                 |
| 15    | 14                    | 63                 |
| 30    | 16                    | 63                 |

## 4.3 Manual Record Adjustments

### 4.3.1 Preparatory Steps

- Load practically new unrecorded tape.

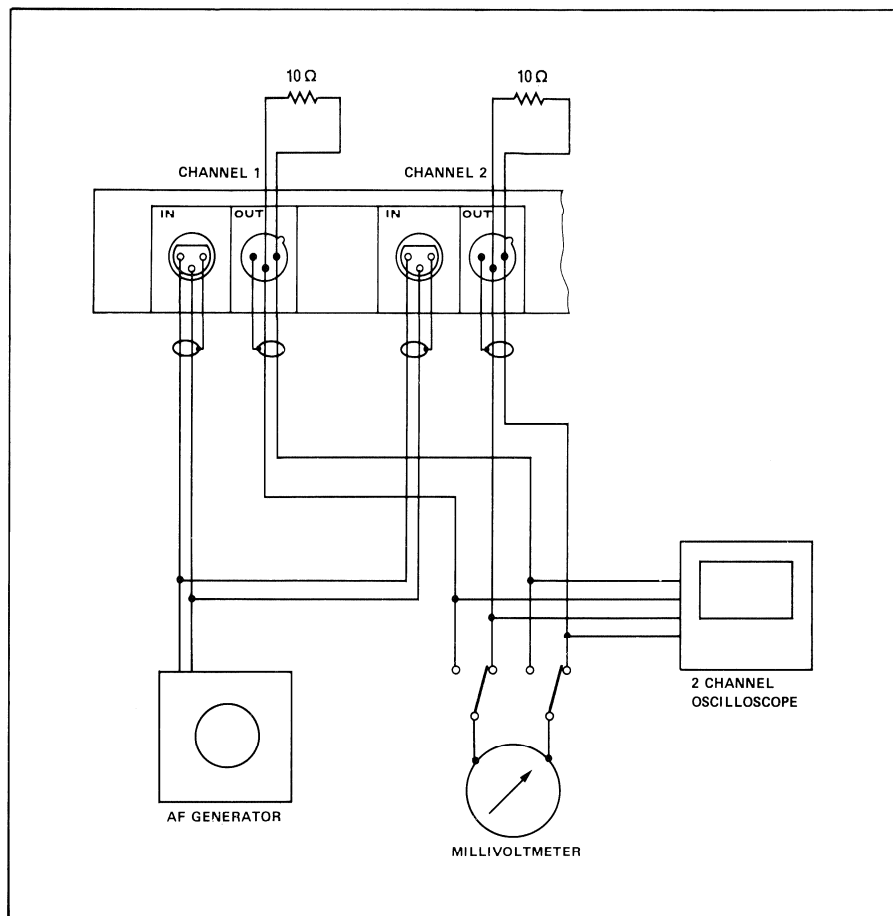
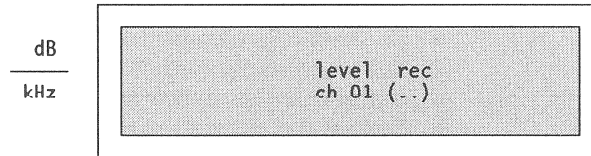

Fig. 4.3.1

- Connect AF generator with 1 kHz and line level to the line inputs and the millivoltmeter to the line outputs, or use the internal generator and the built-in meters (refer to Section 2.5.21). A reference frequency of 700 Hz can be fed when aligning to NAB standards.
- Make sure that the preparatory adjustments in Section 4.1.6 have been made.

4.3.2 Rec Level Prealignment

- Switch recorder on and press ALL READY and ALL REPRO keys.
- Select preferred studio tape speed and equalization.
- Set generator to 1 kHz (or 700 Hz, NAB) at line level.
- Press MANUAL ALIGN and RECORD LEVEL on the audio alignment keyboard.



| METER SECTION     |               |                | ALIGNMENT SECTION |               |              |                 | NRS          |
|-------------------|---------------|----------------|-------------------|---------------|--------------|-----------------|--------------|
| METER ON          | M REF ↓       | M REF ↑        | AUTOREC ALIGN     | AUTOPAR ALIGN | MANUAL ALIGN | STORE START     | NRS ALIGN    |
| 0 dB              | -10 dB        | -20 dB         | REPRO LEVEL       | REPRO TREBLE  | REPRO BASS   | REF TAPE PRESET | UNCAL MODE   |
| 30 Hz SWEEP →     | 1 kHz SWEEP → | 10 kHz SWEEP → | RECORD LEVEL      | RECORD TREBLE | RECORD BIAS  | BIAS PRESET     | MANUAL ALIGN |
| GEN ON            | GENFREQ ↓     | GENFREQ ↑      | CHANNEL ←         | CHANNEL →     | PARAM ↓      | PARAM ↑         | AUTO ALIGN   |
| GENERATOR SECTION |               |                | ALIGNMENT SECTION |               |              |                 | NRS          |

- Select the desired channel with the keys CHANNEL▶ and CHANNEL◀, or by pressing the REPRO key of the desired channel.
- Start recorder in RECORD mode.
- Adjust the record level for the desired line level by pressing the keys PARAM↑ or PARAM↓. The LC display indicates HEX (hexadecimal) values.
- Press STORE if the level is reached.
- Repeat adjustment for all remaining channels.

### 4.3.3 Azimuth Alignment of the Record Head

If the bias has not been set yet, the parameters should be set to the same or similar values for all channels, refer to Section 4.3.4 (reason: the mechanical and the "electrical" head gap of the record head are not in the same position; their distance depends on the magnitude of the bias current. For this reason an azimuth correction must be made after the final bias alignment).

- Set AF generator to 10 kHz and decrease level by 20 dB.
- Connect millivoltmeter to channel 1.
- Start recorder in RECORD mode.
- Set all channels to REPRO and measure at the line outputs.
- Correct the azimuth of the record head by means of the azimuth alignment screw until the highest output voltage and simultaneously the lowest level fluctuations are attained.

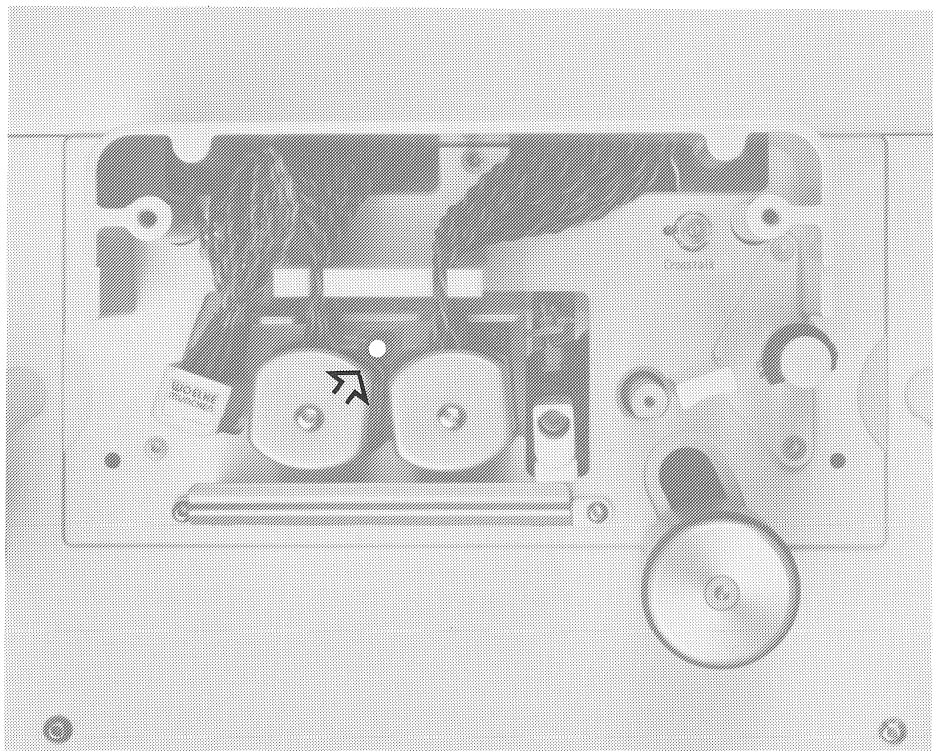

Fig. 4.3.3

#### Coarse adjustment:

- While recording, correct the azimuth of the record head until the maximum output level is attained.

#### Fine-adjustment:

Align for optimum phase between the channels, either

- by connecting them, one after the other, to the inputs of a 2-channel oscilloscope while playing a recording with 8, 10 or 16 kHz, and by further correcting with the azimuth alignment screw for minimum phase difference of the line output signals (use channel 1 as reference),
- or
- by connecting them, one after the other, to the inputs of an AF millivoltmeter with summing facility while playing a recording with 8, 10 or 16 kHz and by further correcting with the azimuth alignment screw to maximum level of the sum of both line output signals (use channel 1 as reference).

**Important:** Always align to maximum level first and then to minimum phase difference! If the inclination of the reproduce head is significantly modified, additional maxima, but with lower level, can occur. To make sure, check phase with a slightly different frequency.  
 If significant corrections of the azimuth alignment have been made, repeat the record level prealignment (Section 4.3.2)!

**4.3.4 Bias Adjustment**

- Set AF generator to 10 kHz and the level 20 dB below line level.
- Connect millivoltmeter to the line outputs.
- Press ALL REPRO and ALL READY.
- Press MANUAL ALIGN and RECORD BIAS on the audio alignment keyboard.

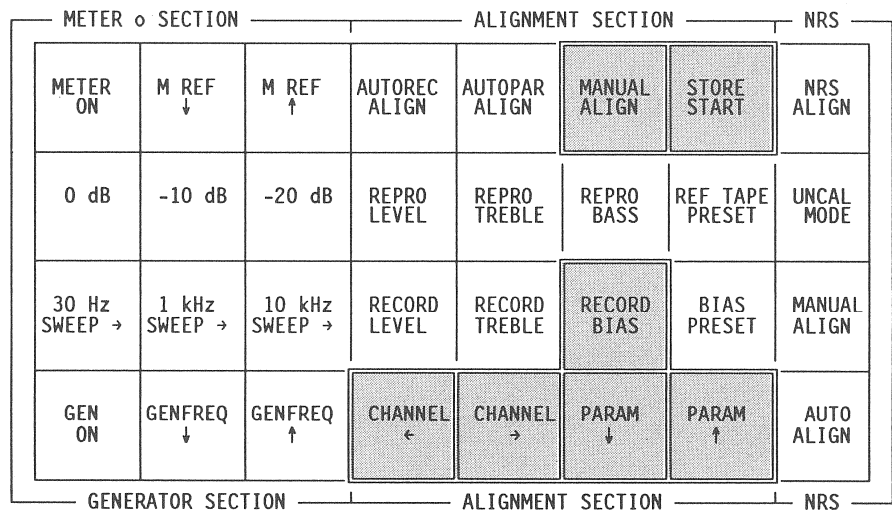
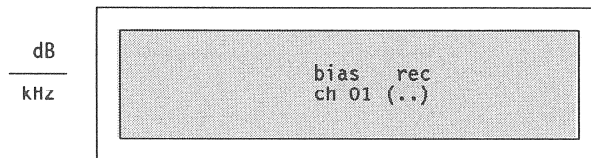

- Select the desired channel with the keys CHANNEL▶ and CHANNEL◀ or by pressing the REPRO key of the desired channel.
- Start recorder in RECORD mode.
- Set the bias current to zero by pressing PARAM↓ until the LC Display indicates 00.
- Press PARAM↑ in order to attain the maximum output voltage, write down or remember the value. Continue pressing PARAM↑ until the output level drops by ΔU.
- ΔU depends on the tape speed and tape type and can be determined from the BIAS table at the end of this Section.
- Press STORE.
- Repeat adjustment for all remaining channels.
- Recheck record azimuth adjustment.



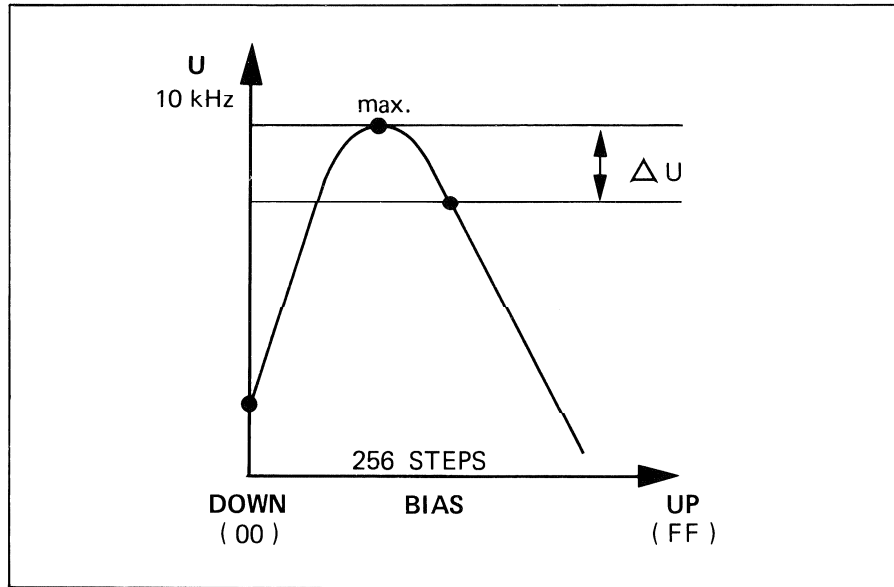

Fig. 4.3.4

**Bias Adjustment Parameters ("ΔU" Values)**

| Type of tape           | $\Delta U$ [dB]    |                   |                   |
|------------------------|--------------------|-------------------|-------------------|
|                        | 19 cm/s<br>7,5 ips | 38 cm/s<br>15 ips | 76 cm/s<br>30 ips |
| Agfa PEM 468           | 6                  | 3,5               | 1,5               |
| Agfa PEM 469           | 7                  | 5                 | 2                 |
| Agfa PER 525           | 6                  | 3                 | 1                 |
| Agfa PER 528           | 6                  | 3,5               | 1,5               |
| Ampex 406              | 5                  | 3                 | 1,5               |
| Ampex 456 GRAND MASTER | 6,5                | 3,5               | 1,5               |
| BASF LGR 30P           | 6                  | 4                 | 1,5               |
| BASF LGR 50P           | 6                  | 4                 | 1,5               |
| BASF SPR 50LH/50LHL    | 5,5                | 3,5               | 1,5               |
| BASF STUDIO MASTER 910 | 6                  | 4,5               | 1,5               |
| BASF STUDIO MASTER 911 | 6,5                | 4,5               | 3                 |
| EMI 816/817            | 6,5                | 4                 | 1,5               |
| PYRAL CJ90             | 6,5                | 3,5               | 1,5               |
| SCOTCH (3M) 206        | 5,5                | 3                 | 1,5               |
| SCOTCH (3M) 226        | 6                  | 3,5               | 1,5               |
| SCOTCH (3M) 250        | 6                  | 3,5               | 1                 |
| SCOTCH (3M) 256        | 6,5                | 3,5               | 1                 |
| SCOTCH (3M) 263        | 6                  | 3                 | 1                 |

### 4.3.5 Record Level Adjustment

- Set AF generator to 1 kHz (700 Hz) and line level.
- Connect millivoltmeter to the line outputs.
- Press ALL REPRO and ALL READY.
- Press MANUAL ALIGN and RECORD LEVEL on the audio alignment keyboard.

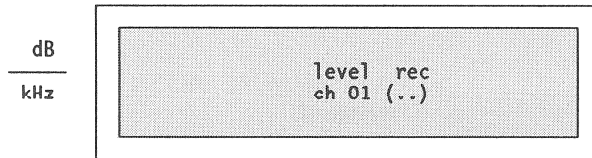

| METER SECTION     |               |                | ALIGNMENT SECTION |               |              |                 | NRS          |
|-------------------|---------------|----------------|-------------------|---------------|--------------|-----------------|--------------|
| METER ON          | M REF ↓       | M REF ↑        | AUTOREC ALIGN     | AUTOPAR ALIGN | MANUAL ALIGN | STORE START     | NRS ALIGN    |
| 0 dB              | -10 dB        | -20 dB         | REPRO LEVEL       | REPRO TREBLE  | REPRO BASS   | REF TAPE PRESET | UNCAL MODE   |
| 30 Hz SWEEP →     | 1 kHz SWEEP → | 10 kHz SWEEP → | RECORD LEVEL      | RECORD TREBLE | RECORD BIAS  | BIAS PRESET     | MANUAL ALIGN |
| GEN ON            | GENFREQ ↓     | GENFREQ ↑      | CHANNEL ←         | CHANNEL →     | PARAM ↓      | PARAM ↑         | AUTO ALIGN   |
| GENERATOR SECTION |               |                | ALIGNMENT SECTION |               |              |                 | NRS          |

- Select the desired channel with the keys CHANNEL▶ and CHANNEL◀ or by pressing the REPRO key of the desired channel.
- Start recorder in RECORD mode.
- Adjust the record level for the desired line level by pressing the keys PARAM↑ or PARAM↓. The LC display indicates HEX (hexadecimal) values.
- Press STORE if the level is reached.
- Repeat adjustment for all remaining channels.

### 4.3.6 Record Frequency Response Alignment

- Set AF generator to line level – 20 dB.
- Connect millivoltmeter to the line outputs.
- Press ALL REPRO and ALL READY.

#### Treble Adjustment:

- Press MANUAL ALIGN and RECORD TREBLE on the audio alignment keyboard.

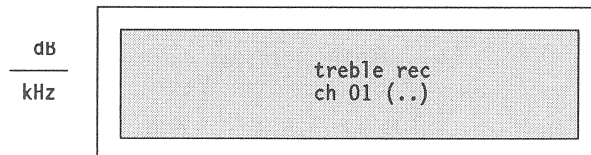

| METER SECTION     |               |                | ALIGNMENT SECTION |               |              |                 | NRS          |
|-------------------|---------------|----------------|-------------------|---------------|--------------|-----------------|--------------|
| METER ON          | M REF ↓       | M REF ↑        | AUTOREC ALIGN     | AUTOPAR ALIGN | MANUAL ALIGN | STORE START     | NRS ALIGN    |
| 0 dB              | -10 dB        | -20 dB         | REPRO LEVEL       | REPRO TREBLE  | REPRO BASS   | REF TAPE PRESET | UNCAL MODE   |
| 30 Hz SWEEP →     | 1 kHz SWEEP → | 10 kHz SWEEP → | RECORD LEVEL      | RECORD TREBLE | RECORD BIAS  | BIAS PRESET     | MANUAL ALIGN |
| GEN ON            | GENFREQ ↓     | GENFREQ ↑      | CHANNEL ←         | CHANNEL →     | PARAM ↓      | PARAM ↑         | AUTO ALIGN   |
| GENERATOR SECTION |               |                | ALIGNMENT SECTION |               |              |                 | NRS          |

- Select the desired channel with the keys CHANNEL▶ and CHANNEL◀ or by pressing the REPRO key of the desired channel.
- Start recorder in RECORD mode.
- Adjust for optimum frequency response by pressing the keys PARAM↑ or PARAM↓. The LC display indicates HEX (hexadecimal) values.

| TAPE SPEED |       | ADJUSTING FREQU. |
|------------|-------|------------------|
| [cm/s]     | [ips] | [kHz]            |
| 19         | 7.5   | 10               |
| 38         | 15    | 12,5             |
| 76         | 30    | 16               |

- Press STORE when the desired level is reached.
- Repeat adjustment for all remaining channels.

## Changing the record standard equalization:

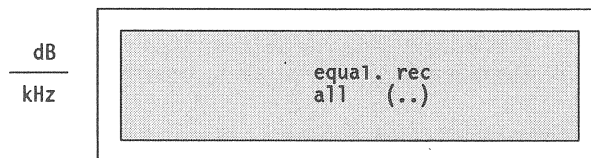

### Default values:

|         | CCIR    |       | NAB     |       |
|---------|---------|-------|---------|-------|
|         | 8/16 CH | 24 CH | 8/16 CH | 24 CH |
| 30 ips  | D3      | D3    | D3      | D3    |
| 15 ips  | BA      | C0    | 99      | AA    |
| 7.5 ips | A2      | AA    | A9      | B8    |

For special situations it is possible to modify the record frequency response by slightly shifting the time constant for the record standard equalization.

The record standard equalization time constant is set for all channels in common as follows:

- Press MANUAL ALIGN and 4 times RECORD TREBLE.
- Start recorder in RECORD mode.
- The time constant can be reduced by pressing PARAM↑, i.e. the transition frequency is shifted toward higher frequencies.
- Press STORE after the optimum frequency response has been found.

| THEORETICAL STANDARD EQUALIZATION ADJUSTMENTS |                         |                   |
|---|-------------------------|-------------------|
| STANDARD TIME CONSTANT [μs]                   | TRANSITION FREQU. [kHz] | RECORD HEX. VALUE |
| 120   | 1.326                   | 0E                |
| 90  | 1.768                   | 4C                |
| 70  | 2.273                   | 75                |
| 50  | 3.150                   | 82                |
| 35  | 4.547                   | BA                |
| 17.5  | 9.094                   | DE                |

## Adjusting the erase current:

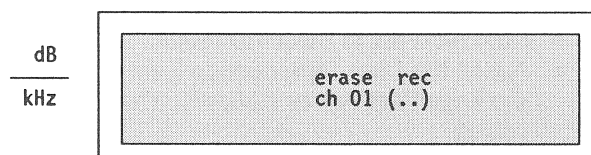

The erase current is factory adjusted (Default value A0 Hex for 24 CH heads and C0 Hex for 8/16 CH heads). Erase current adjustment is however possible, if necessary.

- Press MANUAL ALIGN and 4 times RECORD BIAS.
- Start recorder in RECORD mode.
- Adjust the erase current by pressing PARAM↑ or PARAM↓.
- Press STORE after the optimum erase current is reached. Check erase efficiency and signal to noise ratio.
- Repeat adjustment for the remaining channels.

**Attention:** Drop in/out clicks can occur at too high erase current.

**Bass adjustment: (via tape):**

- Set AF generator to 50...60 Hz, 20 dB below line level.
- Connect millivoltmeter to the line outputs.
- Press ALL REPRO and ALL READY.
- Press MANUAL ALIGN and REPRO BASS on the audio alignment keyboard.

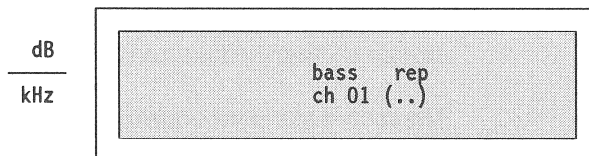

| METER SECTION     |               |                | ALIGNMENT SECTION |               |              |                 | NRS          |
|-------------------|---------------|----------------|-------------------|---------------|--------------|-----------------|--------------|
| METER ON          | M REF ↓       | M REF ↑        | AUTOREC ALIGN     | AUTOPAR ALIGN | MANUAL ALIGN | STORE START     | NRS ALIGN    |
| 0 dB              | -10 dB        | -20 dB         | REPRO LEVEL       | REPRO TREBLE  | REPRO BASS   | REF TAPE PRESET | UNCAL MODE   |
| 30 Hz SWEEP →     | 1 kHz SWEEP → | 10 kHz SWEEP → | RECORD LEVEL      | RECORD TREBLE | RECORD BIAS  | BIAS PRESET     | MANUAL ALIGN |
| GEN ON            | GENFREQ ↓     | GENFREQ ↑      | CHANNEL ←         | CHANNEL →     | PARAM ↓      | PARAM ↑         | AUTO ALIGN   |
| GENERATOR SECTION |               |                | ALIGNMENT SECTION |               |              |                 | NRS          |

- Select the desired channel with the keys CHANNEL▶ and CHANNEL◀ or by pressing the REPRO key of the desired channel.
- Start recorder in RECORD mode.
- Adjust the bass reproduction level for a flat frequency response by pressing the keys PARAM↑ or PARAM↓. The LC display indicates HEX (hexadecimal) values.
- Press STORE if the desired frequency response is reached.
- Repeat adjustment for all remaining channels.

### 4.3.7 Cross Talk Adjustment

- Connect AF generator (line level, 1 kHz) to the line input channel 1, and connect a selective millivoltmeter (center frequency 1 kHz) to the line output channel 2.
- Switch both channels to READY.
- Start machine in RECORD mode.
- Adjust for minimum output voltage with the aid of the CROSSTALK potentiometer.
- Repeat the same measurement with swapped channels. If pronounced differences occur, an optimum value has to be found for both channels.

Check an other pair of channels and adjust for minimum output voltage. Make a compromise between the two measurements and adjust the CROSSTALK potentiometer accordingly.

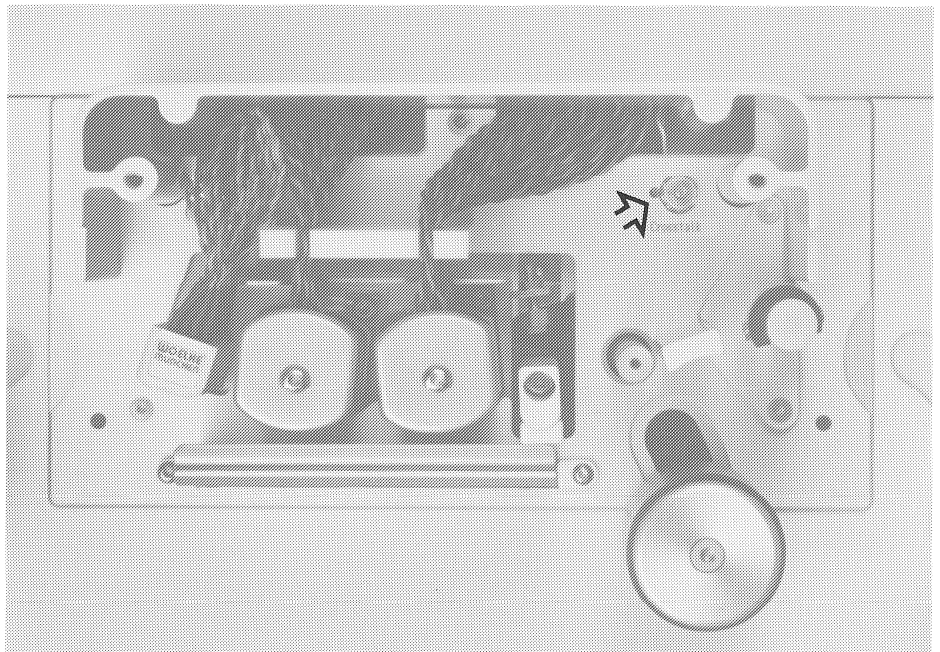

Fig. 4.3.8

#### 4.4 Manual Sync Reproduction Adjustments

- Switch recorder off and wait 5 seconds.
- Set the jumper of the REPRODUCE AMPLIFIERS to NARROW (or to WIDE if a wider frequency response is desired – however considerable cross talk from the recording channel into the SYNC reproduce channel must be expected in this case).

The SYNC reproduce adjustments are identical to the reproduce adjustments with the following exceptions:

- On the panel select SYNC instead of REPRO (the LC Display indicates SYNC LEVEL, SYNC TREBLE, SYNC BASS instead of REPRO LEVEL, REPRO TREBLE, or REPRO BASS, respectively).
- Do not change the mechanical alignment of the heads.

#### Changing the reproduce standard equalization:

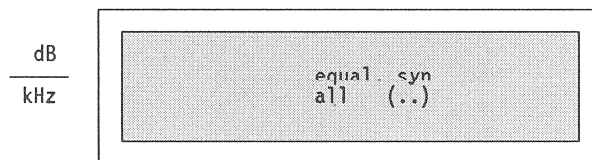

Default values:

|         | CCIR    |       | NAB     |       |
|---------|---------|-------|---------|-------|
|         | 8/16 CH | 24 CH | 8/16 CH | 24 CH |
| 30 ips  | 26      | 2C    | 26      | 2C    |
| 15 ips  | 44      | 58    | 61      | 79    |
| 7.5 ips | 7C      | 97    | 69      | 85    |

For special situations it is possible to modify the sync frequency response by slightly shifting the time constant for the sync standard equalization.

The sync standard equalization time constant is set for all channels in common as follows:

- Press MANUAL ALIGN and 4 times REPRO TREBLE.
- Start recorder in PLAY mode.
- The time constant can be increased by pressing PARAM↑, i.e. the transition frequency is shifted toward lower frequencies. Press STORE after the optimum frequency response has been found.

The following table shows the theoretical equalization values:

| THEORETICAL STANDARD EQUALIZATION ADJUSTMENTS |                         |                       |
|---|-------------------------|-----------------------|
| STANDARD TIME CONSTANT [μs]                   | TRANSITION FREQU. [kHz] | SYNC REPRO HEX. VALUE |
| 120   | 1.326                   | E5                    |
| 90  | 1.768                   | A3                    |
| 70  | 2.273                   | 87                    |
| 50  | 3.150                   | 61                    |
| 35  | 4.547                   | 44                    |
| 17.5  | 9.094                   | 26                    |

**Bass adjustment:**

---

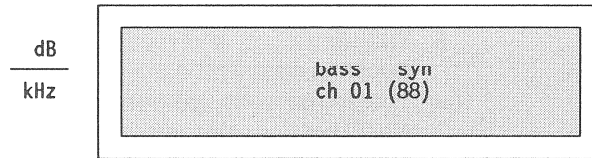

Multichannel tape recorders are normally calibrated with track compensated reference tapes.

Frequency response errors at low frequencies occur when calibrating with non track-compensated reference tapes (caused by fringing effects) in stereo and two-channel models at low frequencies.

For this reason it is recommended to adjust the SYNC reproduce frequency response for low frequencies via tape, i.e. the sync reproduce frequency response adjustment should be repeated with a test tape prepared by the user if no reference tape with the correct track separation is available (approximately 3 minutes each: 1 kHz (NAB 700 Hz), 10 kHz (8 kHz for 7 1/2 ips), 50 Hz).



## 4.5 Automatic Audio and Dolby Adjustments

**Prerequisites:**

- Refer to Sections 4.1.1 through 4.1.7.
- The reproduce and record head azimuth is assumed to be correct. Refer to Sections 4.2.3 and 4.3.3.
- The adjustments are possible for every tape speed, both tape types A and B (CCIR/NAB switch over possibility), every tape width 1" / 2", 8 channel, 16 channel, 24 channel.  
All audio parameters are stored in the RAM of the Audio MPU.

**Note:** If the test tone section on the reference tape should be too short, rewind the tape with LOC START and preselect PLAY before the end of the test tone. The alignment procedure is automatically suspended and resumed as soon as the test tone section is reproduced again.

### 4.5.1 Automatic Reproduce Adjustments

#### Reference Reproduce Level Adjustment:

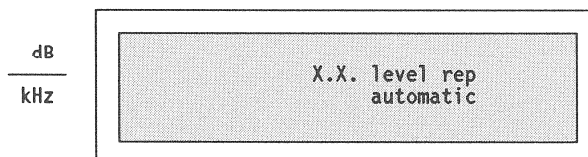

This function is used to select the recorder's reference fluxivity with respect to the reference fluxivity on the test tape.

**Example:**

- Given parameters:
  - Equalization NAB
  - Level meter characteristics: VU-meter
  - Line level: +4/10 dBm
  - Reference fluxivity of the test tape: 200 nWb/m
- Desired reference fluxivity: 320 nWb/m
- $$\text{Level difference} = 20 \log_{10} \times \frac{200 \text{ nWb/m}}{320 \text{ nWb/m}} = -4.1 \text{ dB}$$

(Refer also to Section 4.1.5)

If the same reference fluxivity as on the test tape is to be adjusted (in our example 200 nWb/m), then set the reference level of the tape recorder to 0.0 dB.

**Procedure:**

- Press AUTOPAR ALIGN.
- Press REPRO LEVEL.
- Press REF TAPE PRESET.
- Press METER REF↑ or METER REF↓ until the desired reference level difference (see example above) is indicated in the top left corner of the LC display.
- Press STORE/START.

## Reproduce level adjustment:

---

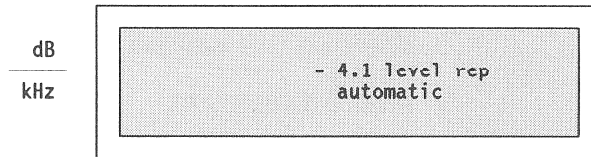

- Press MASTER SAFE before threading the reference tape.
- Thread the reference tape, wind to the reference level section (1 kHz or 700 Hz).
- Switch all channels to REPRO.
- Unused channels can be switched off completely by pressing CHANNEL OFF together with the SAFE key of the desired channel.
- Press PLAY.
- Press STORE/START.

The LC display indicates:

- 4.1 level rep  
adjusting

- After the reproduce level alignment, the LC display indicates:

- 4.1 level rep  
adjusted

- If one (or more) of the active channels cannot be aligned by the AUTOPAR ALIGN routine, the concerned channel(s) will be switched off.

The LC display indicates:

- 4.1 level rep  
failed

All other channels, however, are aligned correctly. For the channels that could not be aligned, the previous parameters remain stored.  
If more than 1/3 of the active channels could not be aligned, all channels are switched off.

## Reproduce frequency response alignment

---

Before aligning the reproduce frequency response, select the recorder's reference level with respect to the level of the frequency response section on the test tape.

Proceed as described in the "Reference reproduce level adjustment" section above, but select REPRO TREBLE or REPRO BASS instead of REPRO LEVEL.

Assuming that, in the example above, the level of the frequency response section on the test tape is 10 dB below the reference level, the recorder's reference level is to be set to:  $-4.1\text{dB} - 10\text{dB} = \underline{-14.1\text{dB}}$ .

- Procedure:**
- Press AUTOPAR ALIGN.
  - Press REPRO TREBLE.
  - Press REF TAPE PRESET.
  - Press METER REF↑ or METER REF↓ until the desired reference level difference (see example above) is indicated in the top left corner of the LC display.
  - Press STORE/START.

**Reproduce treble adjustment:**

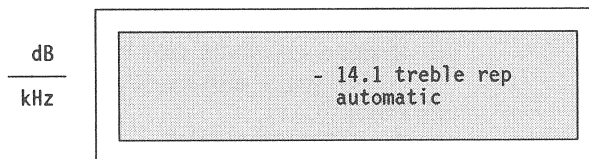

- Press MASTER SAFE before threading the reference tape.
- Thread the reference tape, wind to the treble frequency response section.
- Recommended frequencies: 16 kHz at 30 ips, 14 kHz at 15 ips, 12.5 kHz at 7.5 ips.
- Unused channels can be switched off by pressing CHANNEL OFF together with the SAFE key of the desired channel.
- Press PLAY.
- Press STORE/START.

The LC display indicates:

-14.1 treble rep  
adjusting

- After the treble alignment, the LC display indicates:

-14.1 treble rep  
adjusted

- If one (or more) of the active channels cannot be aligned by the AUTOPAR ALIGN routine, the concerned channel(s) will be switched off.

The LC display indicates:

-14.1 treble rep  
failed

All other channels, however, are aligned correctly. For the channels that could not be aligned, the previous parameters remain stored. If more than 1/3 of the active channels could not be aligned, all channels are switched off.

## Reproduce bass adjustment:

---

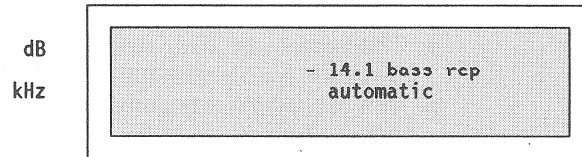

**Note:** If non track-compensated test tapes are used for the reproduce (and sync reproduce) alignment of multichannel recorders, strong fringing effects can occur at low frequencies. To ensure that a linear reproduce frequency response is attained, the reproduce (and sync reproduce) adjustment of the bass frequencies must either be repeated with tape present (after the record alignment) or, if no record adjustments are planned, a calibration tape with track compensation should be used!

- Press MASTER SAFE before threading the reference tape.
- Thread the reference tape. wind to the low frequency response section.
- Unused channels can be switched off by pressing CHANNEL OFF together with the SAFE key of the desired channel.
- Press PLAY.
- Press STORE/START.

The LC display indicates:

```
-14.1 bass rep
      adjusting
```

- After the bass alignment, the LC display indicates:

```
-14.1 bass rep
      adjusted
```

- If one (or more) of the active channels cannot be aligned by the AUTOPAR ALIGN routine, the concerned channel(s) will be switched off.

The LC display indicates:

```
-14.1 bass rep
      failed
```

All other channels, however, are aligned correctly. For the channels that could not be aligned, the previous parameters remain stored.

If more than 1/3 of the active channels could not be aligned, all channels are switched off.

### 4.5.2 Automatic Sync Reproduction Adjustments

---

The SYNC reproduction adjustments are performed exactly the same way as the REPRO adjustments. The only exception is that SYNC has to be selected instead of REPRO for the channels to be aligned.

### 4.5.3 Automatic Record Adjustments

**Prerequisites:**

- Refer to Sections 4.1.1 through 4.1.7.
- The reproduce and record head azimuth is assumed to be correct. Refer to Sections 4.2.3 and 4.3.3.
- The reproduce adjustments must have been made as well (refer to Section 4.5.1).

**Record bias preset:**

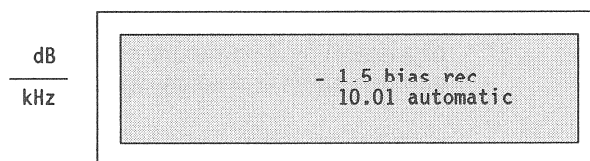

"Delta U"-values are stored as default values for every tape speed (7.5 ips: -6.0 dB; 15 ips: -3.5 dB; 30 ips: -1.5 dB).

If these values do not correspond to those in the "bias adjustment parameters" table, Section 4.9, they can be modified as follows:

- Press AUTOPAR ALIGN
- Press RECORD BIAS
- Press BIAS PRESET.
- Press METER REF↑ or METER REF↓ until the desired Delta-U-value is indicated in the top left corner of the LC display.
- Press STORE/START.

**Record bias adjustment:**

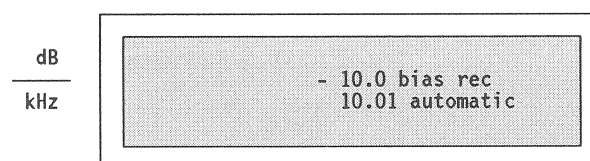

The number in the top left corner of the LC display indicates the generator level.

- Thread a practically new, unrecorded tape of the same type intended for later use.
- Select the desired tape speed.
- Press AUTOPAR ALIGN and RECORD BIAS.  
The internal test generator is automatically switched on the correct frequency; the level meter display is automatically switched to metering mode.
- Switch all channels to READY.
- Unused channels can be switched off completely by pressing CHANNEL OFF together with the SAFE key of the desired channel.
- Press REC together with PLAY.
- Press STORE/START.

The LC display indicates:

```
-10.0 bias  rec
10.01 adjusting
```

- After the bias alignment, the LC display indicates:

```
-10.0 bias  rec
10.01 adjusted
```

- If one (or more) of the active channels cannot be aligned by the AUTOPAR ALIGN routine, the concerned channel(s) will be switched off.

The LC display indicates:

```
-10.0 bias  rec
10.01 failed
```

All other channels, however, are aligned correctly. For the channels that could not be aligned, the previous parameters remain stored.

If more than 1/3 of the active channels could not be aligned, all channels are switched off.

## Record level adjustment:

dB  
kHz

```
0.0 level rec
1.01 automatic
```

The number in the top left corner of the LC display indicates the generator level.

- Thread a practically new, unrecorded tape of the same type intended for later use.
- Select the desired tape speed.
- Press AUTOPAR ALIGN and RECORD LEVEL.  
The internal test generator is automatically switched on to the correct frequency; the level meter display is automatically switched to metering mode.
- Switch all channels to READY.
- Unused channels can be switched off completely by pressing CHANNEL OFF together with the SAFE key of the desired channel.
- Press REC together with PLAY.
- Press STORE/START.

The LC display indicates:

```
0.0 level rec
1.01 adjusting
```

- After the record level alignment, the LC display indicates:

```
0.0 level rec
1.01 adjusted
```

- If one (or more) of the active channels cannot be aligned by the AUTOPAR ALIGN routine, the concerned channel(s) will be switched off. The LC display indicates:

```
0.0 level rec
1.01 failed
```

All other channels, however, are aligned correctly. For the channels that could not be aligned, the previous parameters remain stored. If more than 1/3 of the active channels could not be aligned, all channels are switched off.

### Record treble adjustment:

|                    |   |
|--------------------|---|
| dB<br>-----<br>kHz | <div style="border: 1px solid black; padding: 10px; width: fit-content; margin: auto;"> <pre>- 10.0 treble rec 14.00 automatic</pre> </div> |
|--------------------|---|

The number in the top left corner of the LC display indicates the generator level, here -10 dB.

- Load a practically new, unrecorded tape of the same type intended for later use.
- Select the desired tape speed.
- Press AUTOPAR ALIGN and RECORD TREBLE

The internal test generator is automatically switched on to the speed related frequency; the level meter display is automatically switched to metering mode. If another frequency should be desired for the treble adjustment, press GEN FREQ↓ or GEN FREQ↑ until the desired frequency is indicated in the lower left corner of the LC display.

- Switch all channels to READY.
- Unused channels can be switched off completely by pressing CHANNEL OFF together with the SAFE key of the desired channel.
- Press REC together with PLAY.
- Press STORE/START.

The LC display indicates:

```
-10.0 treble rec
14.00 adjusting
```

- After the record treble alignment, the LC display indicates:

```
-10.0 treble rec
14.00 adjusted
```

- If one (or more) of the active channels cannot be aligned by the AUTOPAR ALIGN routine, the concerned channel(s) will be switched off. The LC display indicates:

```
-10.0 treble rec
14.00 failed
```

All other channels, however, are aligned correctly. For the channels that could not be aligned, the previous parameters remain stored.  
If more than 1/3 of the active channels could not be aligned, all channels are switched off.

## Reproduce bass adjustment (via tape):

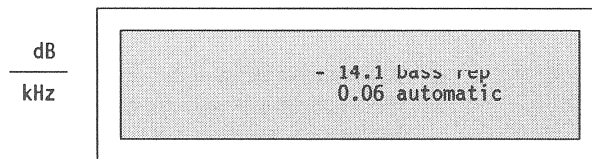

**Note:** This adjustment is necessary only if non track-compensated test tapes have been used for the reproduce (and sync reproduce) alignment of the recorder, to avoid fringing effects at low frequencies. To ensure that a linear reproduce frequency response is attained, the reproduce (and sync reproduce) adjustment of the bass frequencies must be repeated with tape present (after the record alignment).

### Procedure:

- Load a practically new, unrecorded tape of the same type intended for later use.
- Select the desired tape speed.
- Press AUTOPAR ALIGN and REPRO BASS.
- Press 30 Hz/SWEEP→, adjust with GEN FREQ↑↓ the desired frequency.
- Recommended frequencies:
  - 60 Hz at 30 ips,
  - 60 Hz at 15 ips,
  - 40 Hz at 7.5 ips.
- Switch all channels to READY.
- Unused channels can be switched off completely by pressing CHANNEL OFF together with the SAFE key of the desired channel.
- Press REC together with PLAY.
- Press STORE/START.

The LC display indicates:

|                                  |
|----------------------------------|
| -14.1 bass rep<br>0.06 adjusting |
|----------------------------------|

- After the reproduce bass alignment, the LC display indicates:

|                                 |
|---------------------------------|
| -14.1 bass rep<br>0.06 adjusted |
|---------------------------------|

- If one (or more) of the active channels cannot be aligned by the AUTOPAR ALIGN routine, the concerned channel(s) will be switched off.

The LC display indicates:

|                               |
|-------------------------------|
| -14.1 bass rep<br>0.06 failed |
|-------------------------------|



All other channels, however, are aligned correctly. For the channels that could not be aligned, the previous parameters remain stored.

If more than 1/3 of the active channels could not be aligned, all channels are switched off.

## 4.5.4 Fully Automatic Record Adjustments "AUTOREC ALIGN"

---

Sequence: BIAS – LEVEL REC – TREBLE REC – BASS REP

### Prerequisites:

- Refer to Sections 4.1.1 through 4.1.7.
- The reproduce and record head azimuth is assumed to be correct. Refer to Sections 4.2.3 and 4.3.3.
- The reproduce adjustments must have been made as well (refer to Section 4.5.1).
- BIAS PRESET (refer to Section 4.5.3), equalization standard (NAB/CCIR), as well as TAPE TYPE A/B are selected correctly.

### Procedure:

- Load a practically new, unrecorded tape of the same type intended for later use.
- Select the desired tape speed.
- Press AUTOREC ALIGN.
- Switch all channels to READY.
- Unused channels can be switched off completely by pressing CHANNEL OFF together with the SAFE key of the desired channel.
- Press REC together with PLAY.
- Press STORE/START.

The LC display indicates:

|                                 |
|---------------------------------|
| -20.0 record<br>10.01 adjusting |
|---------------------------------|

- After the record alignment, the LC display indicates:

|                               |
|-------------------------------|
| -20.0 record<br>0.04 adjusted |
|-------------------------------|

- If one (or more) of the active channels cannot be aligned by the AUTOREC ALIGN routine, the concerned channel(s) will be switched off. The LC display indicates:

|                              |
|------------------------------|
| -20.0 record<br>10.01 failed |
|------------------------------|

All other channels, however, are aligned correctly. For the channels that could not be aligned, the previous parameters remain stored.

If more than 1/3 of the active channels could not be aligned, all channels are switched off.

#### 4.5.5 A820 MCH Dolby/Telcom Alignment Instructions

Instructions for the use of: Dolby A, Dolby SR and Telcom C4 noise reduction modules inside the STUDER A820 MCH. The A820 MCH has to be equipped with the following or more recent software versions:

|                         |       |
|-------------------------|-------|
| Master software         | 20/89 |
| Audio software          | 20/89 |
| VU-Meter Panel software | 20/89 |

For more information concerning software releases contact STUDER INTERNATIONAL or your local STUDER dealer.

- Remarks:**
- The TELCOM system is related to peak recording level. The DOLBY systems are related to operating level.
  - Channels where NR is activated will switch automatically from Decode (Play) to Encode (Record) at drop-in, and back to Decode (Play) at drop-out. In Record the monitor receives the input signal, while in Repro / Sync it receives the signal off-tape, as it is normal for multitrack operation. Selecting 'Repro' when in Record with NR active overrides this, sending the encoded signal directly to the monitor for a confidence playback check.
  - In "NRS TONE" and "NRS ALIGN" modes, the NR system will automatically switch to "BYPASS" for alignment and measuring purposes (Audio Alignment). The Record- and Reproduce adjustments of the machine are not influenced by the Noise Reduction System.

#### Level Standardisation with Dolby systems

Dolby A-type and Dolby SR are complementary systems: that is, the processing applied during playback is a mirror image of that applied when recording. In addition, the process is dependant on both level and frequency of the signal being recorded. This gives great flexibility in the way that the processing adapts to the incoming signal, but it means that for correct operation the levels in the playback processor must be the same as those in the record processor when the recording was made. In most studios all this really means is that the recorder should be at unity gain which is the normal situation.

To ensure that the play processor gets this same signal level as the original record processor (which may be in a different studio) it is necessary to record a test signal onto the tape to indicate how the Dolby processing was set when the recording was made. To facilitate this, reference signals unique to Dolby systems are used to indicate Dolby level.

#### Dolby Reference Signals

Dolby tone (for A-type recordings) is 850 Hz, with a short (30 milliseconds) upward frequency modulation to 935 Hz roughly every three-quarters of a second. This produces a characteristic warble sound which is quite unmistakable. Dolby tone is recorded at Dolby level.

Dolby noise (for SR recordings) is pink noise with a 20 millisecond pause ("nick") every 2 seconds. This too produces an easily-identifiable "signature". Dolby noise is recorded on tape at 15 dB below Dolby level, but this difference is accounted for when Dolby noise is replayed in the calibration mode.

A further use of Dolby noise is called Auto Compare. On playback the signal sent to the monitor alternates automatically between 4 seconds of the Dolby noise from tape and four seconds of pink noise. The nicks identify the tape section, and two lights on the module provide a confirming indication. It is remarkably easy to listen and compare the levels and frequency response of the complete recording chain in a very sensitive manner. While the SR process is less sensitive to any errors than the A-type system, it is extremely easy to detect small errors which the operator may wish to correct.

The Dolby reference signals will also identify which tracks have been recorded with Dolby processing, as the Dolby tone/noise can only be recorded on tracks where the relevant Dolby processing is switched on.

## Dolby Level

On analogue audio tape, Dolby level will typically be between 185 nWb/m and 320 nWb/m. The choice of which level to adopt will depend on operating levels and local tape interchange standards. As a guide, most studios use Dolby level that corresponds to "0" VU or -6 dB peak on their recorder meters. This is the default setting of the A820 MCH.

It is an extremely good practice to lay down a few seconds of Dolby tone/noise at the beginning of a new reel or recording so that a future recipient of the tape (maybe in a different country, for example) knows what Dolby level was used. Provided he adjusts his machine so that this section plays back at Dolby level on his meters, decoding will be correct.

## NRS Level Indication

Stand-alone noise reduction units manufactured by Dolby Laboratories all have a meter specifically for indicating Dolby level, and a pushbutton labelled "Set Up" ("Dolby Tone/Cal" on older units) which is used when aligning the system.

The Set up button does the following:

- The factory calibrated Dolby processing is switched out, allowing the alignment of the interface to be observed
- Dolby tone/noise as appropriate is sent to the tape in the Record mode
- The Dolby level meter always reads signal returned from tape. In the case of Dolby SR, where the reference Dolby noise is recorded 15 dB below Dolby level, 15 dB of gain is inserted into the meter circuit and possibly misleading information from the frequency extremes is filtered out.
- Where SR is being used, and Dolby noise is being returned from tape, Auto Compare is initiated.

Exactly the same facilities are implemented on the STUDER A820 MCH. The "Set Up" ("Dolby Tone/Cal") button is replaced by the "NRS TONE" and "NRS ALIGN" buttons. When "NRS TONE" is pressed, Dolby Tone/Noise is sent to the tape. The "NRS ALIGN" button switches the A820 MCH metering to the calibration mode, and the LEDs at the zero point flash to show that this point now indicates Dolby level. The Dolby interface may then be aligned or adjusted via the associated software control.

## NRS Interface Circuit

The NRS Interface circuitry of the A820 MCH contains two digitally controlled gain stages, one before the NR module and one after.

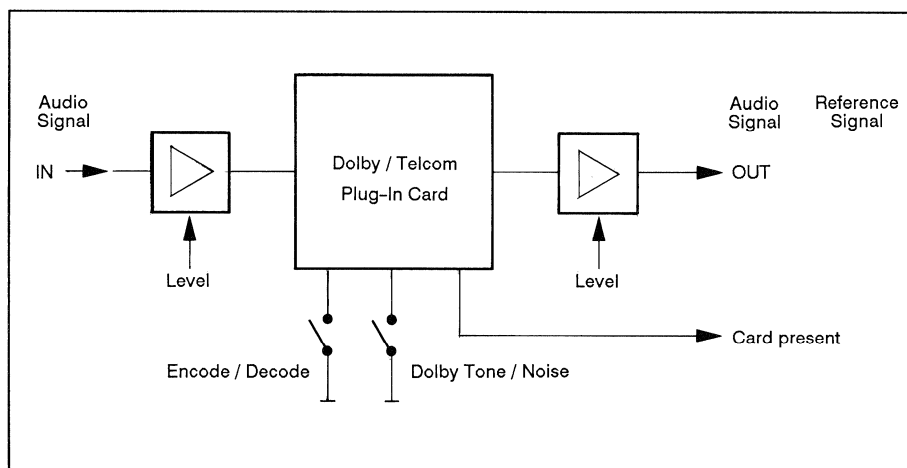

Fig. 4.5.5.1 Blockdiagram 1, valid for: **Dolby SR Cat. 280**  
**Dolby A Cat. 22**  
**Telcom c4D**

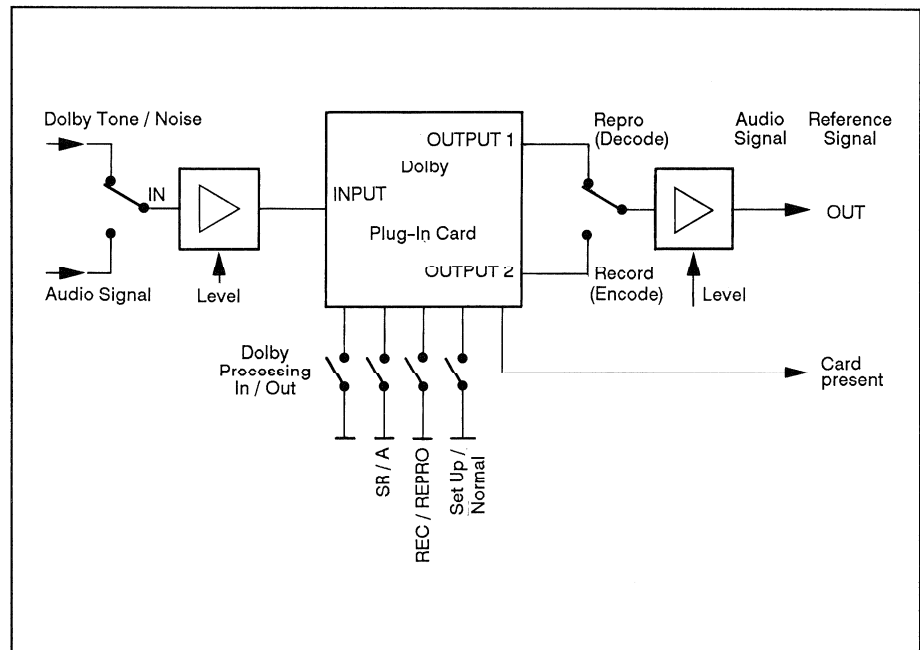

Fig. 4.5.5-2 Blockdiagram 2, default for:  
 Dolby SR/A Cat. 300  
 Dolby SR Cat. 350  
 Dolby A Cat. 450

The A820 MCH software sets the gain of these stages in such a way that the overall gain of the NRS Interface is always unity. The advantage of this arrangement is that the programme levels are independent of the setting of the NRS Interface. The only disadvantage is that any changes to "NRS LEVEL" are not reflected on either the recorder or console meters. However the current settings of the "NRS LEVEL" are precisely shown in the LC display on the panel of the A820 MCH, and may be adjusted if necessary.

In conventional multitrack operation, track monitoring is fed from the Repro or Sync signal when the recorder is in Play; in Record, track monitoring is fed from the input signal. (This is essential with synchronous overdubbing.) However with a tape recorder it is also possible to monitor from Repro while in Record. In the STUDER A820 MCH the same Dolby module is used for both record and play and its mode and position in the signal path are switched appropriately by the record/play logic in the A820. This is identical to the implementation in all stand-alone multitrack units manufactured by Dolby Laboratories. On such units a "Check Tape" facility is provided: this switches the off tape signal directly to the track monitoring. The signal is still Dolby encoded, but the quality of the recording channel can be checked. The same facility is available on the A820MCH, by switching to Repro when in the Record mode when Dolby processing is selected.

**Note:** All Dolby alignment is always carried out with the processing switched out, so that the interface levels can be correctly set. The Dolby processing itself is factory set and can not be adjusted. Due to its "intelligent" nature, different frequencies and levels are treated differently by Dolby processing. For this reason it is standard practice to switch out Dolby processing when aligning the recorder. This is automatically carried out both during the A820 software alignment procedures and whenever the "NRS TONE" button is pressed; however sending tone to tape subsequently, with processing on, may result in level change on tape. For example if tone at Dolby level is sent to any recorder via Dolby processing the following signal level changes may be observed on the recorder meters:

|        | Dolby-A | Dolby-SR |
|--------|---------|----------|
| 1 kHz  | - ½ dB  | ≥ +¼ dB  |
| 10 kHz | +¼ dB   | -5½ dB   |
| 50 Hz  | +¼ dB   | -3 dB    |

Exactly the opposite will be seen on replay. (In fact this can be checked by playing back encoded tones through the Dolby processing – the signal returned to the console will be the same as that sent originally, provided recorder and NRS interface have been aligned). When recording studio reference tones therefore, care should be taken to ensure that the Dolby processing is switched out.

## DOLBY A & TELCOM MODULES:

---

**Using Dolby A-type modules:** Set functions No. 053 to "METERING VU", No. 054 to "NRS DOLBY", and No. 055 to "DOLBY A".

**Using TELCOM c4D/c4E-type modules:** Set functions No. 053 to "METERING PPM", No. 054 to "NRS Telcom", and No. 056 to "TELCOM c4D or c4E".

### RECORD and REPRODUCE Alignment:

- Notes:**
- The following alignment instructions are written for Dolby NR-Systems. They also apply to TELCOM NR-Systems but Dolby Level is replaced by TELCOM Level and the LC-Display indicates in "dB" instead of "VU".
  - As there are only two digitally controlled gain stages (DAC's) – one on the input, one on the output of the NR module – once the interface is aligned for Record or for Play it will be aligned for both.
  - Two different level settings are stored in the memory of the A820 MCH. Both level settings are totally independent and do not influence each other. The two settings are selectable by means of the key "UNCAL MODE (ON/OFF)". In position CAL MODE (LED dark) the same level setting is used for all channels. In position "UNCAL MODE" (LED shines) an individual level setting is used for each channel. The "CAL MODE" should be used as the in-house standard alignment, whereas the UNCAL MODE should be used to align the A820 MCH to incoming customer tapes recorded with noise reduction, as these may need individually adapted channel settings ("Off Tape Alignment"). The key "UNCAL MODE (ON/OFF)" is also an operating key. This means that it must be selected according to the desired mode (CAL/UNCAL MODE) in normal operation mode (NRS ALIGN=OFF).
- Attention:**

### In-House Standard Alignment:

- Dolby Level at 0 VU:** This is the default setting, which is recommended as the in-house standard Dolby Level.
- To set "Dolby A CAL all" to +0.0 VU, perform the following steps:
    - Press "NRS ON" and "ALL SAFE" to switch all NR-Systems on.
    - Press "NRS ALIGN".
    - Press "MANUAL ALIGN"; "UNCAL MODE" is automatically switched ON.
    - Switch the "UNCAL MODE" OFF, as the interface has to be aligned for the CAL MODE.
    - Set for +0.0 VU with the "PARAM UP/PARAM DOWN" buttons.
    - Press "STORE" if the level is reached.
    - Press "NRS ALIGN" again to return to normal operating mode. Dolby Level is now set to 0 VU.

To double check the level setting, press the "NRS TONE" button and record a section of tone on blank tape. The tone should read 0 VU when played back (either with the "NRS TONE" button still pressed or NR switched off).

**Dolby Level not at 0 VU:** Example: 0 VU might correspond to a flux level of 320 nWb/m and the Dolby Level in use might be at 200 nWb/m. Playing a 200 nWb/m test tape on a machine which has been aligned for 320 nWb/m would give a reading of -4 VU.

- To set "Dolby A CAL all" to -4.0 VU, perform the following steps:
    - Press "NRS ON" and "ALL SAFE" to switch all NR-Systems on.
    - Press "NRS ALIGN".
    - Press "MANUAL ALIGN"; "UNCAL MODE" is automatically switched ON.
    - Switch the "UNCAL MODE" OFF, as the interface has to be aligned for the CAL MODE.
    - Set for -4.0 VU with the "PARAM↑ /PARAM↓" buttons.
    - Press "STORE" if the level is reached.
    - Press "NRS ALIGN" again to return to normal operating mode.
- Dolby Level is now set to -4.0 VU.

To double check the level setting, press the "NRS TONE" button and record a section of tone on blank tape. The tone should read -4 VU when played back (either with the "NRS TONE" button still pressed or NR switched off). The in-house standard alignment is now completed.

#### OFF - TAPE Alignment:

There are two ways to align the noise reduction modules inside the A820 MCH to an incoming tape recorded with Noise Reduction:

- A Manual Alignment:**
- Press "NRS ON" and "ALL SAFE" to switch all NR-Systems on.
  - Press "NRS ALIGN".
  - Press "MANUAL ALIGN"; UNCAL MODE is automatically switched ON.
  - Play the Dolby Tone section of the tape.
  - Set for "0" (flashing middle LED) with the PARAM↑/PARAM↓ buttons.
  - Press "STORE" if the level is reached.
  - Repeat the alignment for the remaining channels.
  - Press "NRS ALIGN" again to return to normal operating mode.
- B Automatic Alignment:**
- Press "NRS ON" and "ALL SAFE" to switch all NR-Systems on.
  - Press "NRS ALIGN".
  - Press "AUTO ALIGN"; UNCAL MODE is automatically switched ON.
  - Play the Dolby Tone section of the tape.
  - Press "STORE START"
  - After the automatic alignment is completed, press "NRS ALIGN" again to return to normal operating mode.

- Remarks:**
- If the Dolby Tone section on the tape is too short to complete the automatic alignment process in one cycle, then press "LOC START" (LOC START PLAY must be programmed) before the end of the Dolby Tone in order to rewind and automatically continue the alignment process.
  - If one (or more) of the active channels cannot be aligned by the "AUTO ALIGN" routine, then the NR-System on the concerned channel(s) will be switched OFF and the message "failed" appears.
  - If the machine has been adjusted to a pre-recorded tape with the automatic alignment procedure in UNCAL MODE, then the key "UNCAL MODE" must remain active (i.e. LED must shine) in normal operating mode!

## DOLBY SR modules:

---

### Using Dolby Spectral Recording modules:

Set functions No. 053 to "METERING VU", No. 054 to "NRS DOLBY", and No. 055 to "DOLBY SR".

The alignment of SR differs from A-type in two aspects:

- The alignment signal is pink noise rather than the familiar Dolby Tone. This noise signal known as "Dolby Noise" has short "gaps" every two seconds, similar to the warble in the Dolby Tone.
- Dolby Noise serves not only as a level reference but can be used to check frequency response as well. To facilitate frequency response checks, all SR processors include a facility known as AUTO COMPARE:

- In AUTO COMPARE, the module will output the following sequence:  
4 seconds of noise from the tape followed by 4 seconds of noise from the internal generator. This sequence reveals audibly any level or response errors in the recorder including any Dolby Level misalignment.

The "tape" section of the noise has a 20 ms gap after 2 seconds; the "ref." section from the internal generator is continuous. Lights on the front of each Dolby SR module indicate which signal is being heard at any time.

On the rear of each Dolby SR module is a frame configuration switch used to configure the AUTO COMPARE system as appropriate for different types of interfaces. The switch is labeled "360", "361", and "M" for use with Dolby Laboratories models 360, 361, and M series. For use in the STUDER A820 MCH the switch should be set to the "360" position (to the edge).

On any of the units manufactured by Dolby Laboratories the meter gain of the unit is changed so that when the Dolby Tone button is pressed the meter will read on the Dolby Level dot for noise recorded 15 dB below Dolby Level. The same feature is provided by the A820 MCH software, when "NRS ALIGN" is pressed and the NR-Systems are switched ON: the meters will read on the flashing middle LED for noise recorded at 15 dB below Dolby Level.

### RECORD and REPRODUCE Alignment:

- Notes:**
- As there are only two digitally controlled gain stages (DAC's) - one on the input, one on the output of the NR module - once the interface is aligned for Record or for Play it will be aligned for both.
  - Two different level settings are stored in the memory of the A820 MCH. Both level settings are totally independent and not influence each other. The two settings are selectable by means of the key "UNCAL MODE (ON/OFF)". In position CAL MODE (LED dark) the same level setting is used for all channels. In position "UNCAL MODE" (LED shines) an individual level setting is used for each channel. The "CAL MODE" should be used as the in-house standard alignment, whereas the UNCAL MODE should be used to align the A820 MCH to incoming customer tapes recorded with Noise Reduction, as these may need individually adapted channel setting ("Off Tape Alignment").

### IN-HOUSE Standard Alignment:

#### **Dolby Level at 0 VU (Dolby Noise at -15 dB):**

This is the default setting, which is recommended as the in-house standard Dolby Level.

Set "Dolby SR CAL all" to 0.0 VU if VU-metering mode is selected, or to -6.0 dB if PEAK metering mode is selected, by performing the following steps.

- Press "NRS ON" and "ALL SAFE" to switch all NR-Systems on.
- Press "NRS ALIGN".
- Press "MANUAL ALIGN"; "UNCAL MODE" is automatically switched ON.

- Switch the "UNCAL MODE" OFF, as the interface has to be aligned for the CAL Mode.
- Set for 0.0 VU (in VU metering mode), or -6.0 dB (in PEAK metering mode) with the "PARAM↑ /PARAM↓" buttons.
- Press "STORE" if the level is reached.
- Press "NRS ALIGN" again to return to normal operating mode.  
Dolby Level is now set to 0 VU, resp. -6 dB PEAK.

To double check the level setting, press the "NRS TONE" button and record a section of Dolby Noise on blank tape. The Dolby Noise will be recorded at a level of -15 dB below 0 VU. Rewind the tape. With the "NRS ALIGN" button pressed, Dolby Tone reproduced from tape should read approximately "0" ( $\pm 1$  dB), on channels with flashing middle LED.

**Dolby Level not at 0 VU:** Example: 0 VU might correspond to a flux of 320 nWb/m and the Dolby Level in use might be at to 200 nWb/m. Playing a 200 nWb/m test tape on a machine which has been aligned for 320 nWb/m would give a reading of -4 VU.

- To set "Dolby SR CAL all" to -4.0 VU (or -10.0 dB PEAK), perform the following steps:
  - Press "NRS ON" and "ALL SAFE" to switch all NR-Systems on.
  - Press "NRS ALIGN".
  - Press "MANUAL ALIGN"; "UNCAL MODE" is automatically switched ON.
  - Switch the "UNCAL MODE" OFF, as the interface has to be aligned for the CAL Mode.
  - Set for -4.0 VU (in VU metering mode), or -10.0 dB (in PEAK metering mode) with the "PARAM↑ /PARAM↓" buttons.
  - Press "STORE" if the level is reached.
  - Press "NRS ALIGN" again to return to normal operating mode.  
Dolby Level is now set to -4.0 VU, resp. -10 dB PEAK.

To double check the level setting, press the "NRS TONE" button and record a section of Dolby Noise on blank tape. The Dolby Noise will be recorded at -4 dB below -15dB, i.e. -19 dB below 0 VU in this case.

With the "NRS ALIGN" button pressed, Dolby Tone reproduced from tape should read approximately "0" ( $\pm 1$  dB), on channels with flashing middle LED. The in-house standard alignment is now completed.

#### OFF-TAPE Alignment:

There are two ways to align the noise reduction modules inside the A820 MCH to an incoming tape recorded with Dolby SR:

- A Manual Alignment:**
- Press "NRS ON" and "ALL SAFE" to switch all NR-Systems on.
  - Press "NRS ALIGN".
  - Press "MANUAL ALIGN"; the UNCAL MODE is automatically switched ON.
  - Play the Dolby Noise section of the tape.
  - Set for "0" (flashing middle LED) with the "PARAM↓ /PARAM↑" buttons.
  - Press "STORE" if the level is reached.
  - Repeat the alignment for the remaining channels if "UNCAL MODE" is selected.
  - Press "NRS ALIGN" again to return to normal operating mode.



- B Automatic Alignment:**
- Press "NRS ON" and "ALL SAFE" to switch all NR-Systems on.
  - Press "NRS ALIGN".
  - Press "AUTO ALIGN"; the UNCAL MODE is automatically switched ON..
  - Play the Dolby Noise section of the tape.
  - Press "STORE START".
  - After the automatic alignment is completed, press "NRS ALIGN" again to return to normal operating mode.

The Off-tape alignment is now completed.

- Remarks:**
- If the Dolby Noise section on the tape is too short to complete the alignment process in one cycle, then press "LOC START" (LOC START PLAY must be programmed) before the end of the Dolby Noise in order to rewind and automatically continue the alignment process.
  - If one (or more) of the active channels cannot be aligned with the "AUTO ALIGN" routine, then the NR-System on the corresponding channel(s) will be switched OFF and the message "failed" appears.
  - If the machine has been adjusted to a pre-recorded tape with the automatic alignment procedure in UNCAL MODE, then the key "UNCAL MODE" must remain active (i.e. LED must shine) in normal operating mode!

## **AUTO COMPARE MODE:**

In either of the above cases you can check the level of the Dolby Noise on tape by pressing first "NRS ALIGN" and then "NRS TONE" ("AUTO COMPARE" mode) during reproduction of the Dolby Noise and "soloing" each monitor channel in turn. Both the "tape" and "ref." sections of Dolby Noise should be at the same level. The recorder meters will also alternate between "tape" and "ref.". You can see this on the Dolby cartridges in the machine.

Differences between the two sections will show up as periodic changes in level. In the Off-tape alignment mode (UNCAL MODE), set for minimum level difference for each channel either by using the above AUTO ALIGN process or by using the Manual Alignment process described below.

## **Manual Alignment during AUTO COMPARE MODE**

- Press "NRS ON" and "ALL SAFE" to switch all NR-Systems on.
- Press "NRS ALIGN" and "NRS TONE"
- Press "MANUAL ALIGN"; the UNCAL MODE is automatically switched ON.
- Play the Dolby Noise section of the tape.
- "Solo" each monitor channel in turn. Both the "tape" and the "ref." sections of the Dolby Noise should be at the same level. This check may be done by ear or by using the meters.
- Set for minimum level difference for each channel with the "PARAM↑ /PARAM↓" buttons.
- Press "STORE" if a level difference is no longer audible.
- Repeat the alignment for the remaining channels.
- Press "NRS ALIGN" again to return to normal operating mode.

The off-tape alignment is now corrected.

## 4.6 Time Code Recording

---

### 4.6.1 Installation

Order Number

|                                      |  |               |
|--------------------------------------|--|---------------|
|                                      | Option 20.820.392.00 Time Code Channel with High Speed Reader  |               |
| <b>Conversion Kit consisting of:</b> | 1 Internal NRS CONTROLLER  | 1.820.815.00  |
|                                      | 1 Time Code Line Amplifier   | 1.820.820.81  |
|                                      | 1 Time Code Read Unit  | 1.820.821.00  |
|                                      | 1 Installation Instruction   | 10.27.0720    |
| <b>Application</b>                   | Installation of the time code channel with high speed reader is possible in all STUDER A820 multichannel recoders.   |               |
| <b>Required tools</b>                | 1 Hex screw-driver no. 2.5   | 10.258.003.09 |
| <b>Preparations:</b>                 | <ul style="list-style-type: none"> <li>■ Loosen three screws of the retaining bracket using Hex screwdriver no. 2.5</li> <li>■ Slide the sheet metal retainer upwards</li> <li>■ From the channel which is to become the time code channel, remove the reproduce amplifier 1.820.710.84, the line amplifier 1.820.715.82 and the switching and metering unit 1.820.716.00</li> </ul>   |               |
| <b>Installation</b>                  | <ul style="list-style-type: none"> <li>■ Insert internal NRS CONTROLLER 1.820.815.00 or 1.820.824.00 in place of the switching and metering unit 1.820.716.00</li> <li>■ Insert time code line amplifier 1.820.820.00/81 in place of the line amplifier 1.820.715.82</li> <li>■ Insert time code read unit 1.820.821.00 in place of the reproduce amplifier 1.820.710.84</li> <li>■ Slide the retaining bracket downwards and secure with three screws (Hex screw-driver no. 2.5)</li> </ul> |               |

### 4.6.2 Time Code Channel Alignment

---

- The channel which is equipped for time code operation is indicated on the tape deck display.
- When altering the parameters of the time code channel (equipped with high speed reader), the audio data will remain unchanged. Conversely, the time code parameters will also remain unchanged if the channel is equipped with audio electronics and the audio parameters are altered.
- To switch the code channel from SAFE to READY, the keys SET ENABLE and READY have to be pressed.

### 4.6.3 Adjustment of Time Code Output Level

- Connect time code generator with an output in the range from 0.25 Vpp to 4 Vpp (nominal 2 Vpp) to the time code channel.
- Plug the time code line amplifier 1.820.820.00/81 onto the extension board.
- Connect oscilloscope probe to pin 3 and pin 4 (ground).
- Switch TC-Channel on "Input"
- Adjust output level with trimmpotentiometer R86 to 1.9 Vpp
- The bargraph display (in VU mode) must now indicate 0 VU ±1 segment or -6 dB ±1 segment when switched to the PPM mode.
- Insert time code line amplifier into the recorder without the extension board.

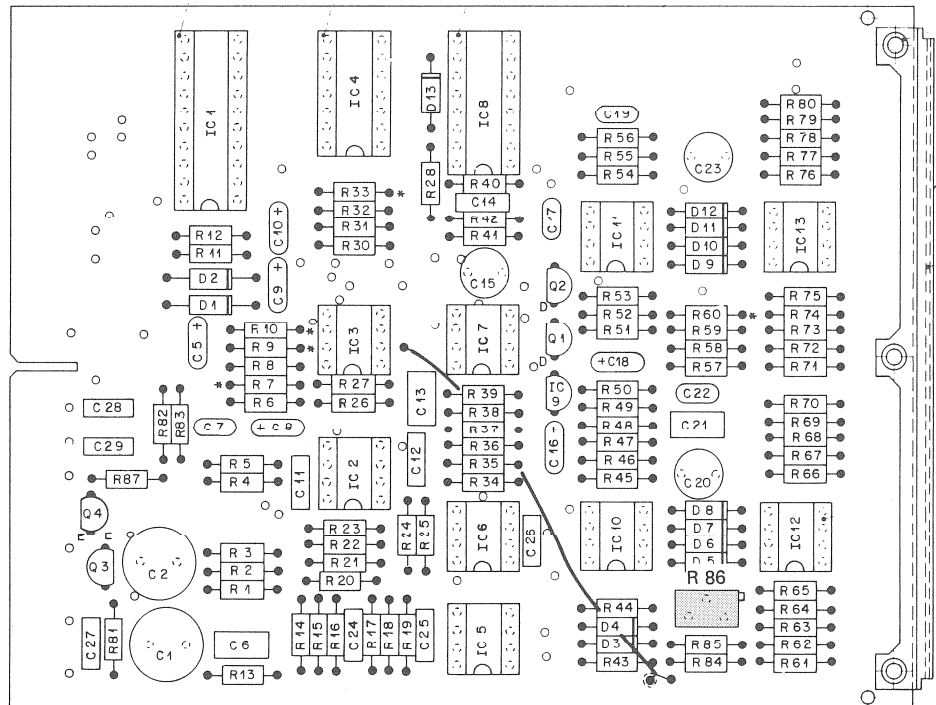

Fig. 4.6.3

### 4.6.4 Adjustment of Time Code Reproduce Level

- The recommended time code record level is -10 VU (VU mode) or -16 dB (PPM mode).
- Plug time code read unit 1.820.821.00 onto the extension board.
- Switch time code channel to REPRO and SAFE.
- Load the machine with an audio calibration tape of desired equalization and matching the most used tape speed. Wind forward to the »REFERENZ LEVEL 1 kHz«
- Start the machine in PLAY
- Adjust time code level with trimmpotentiometer R84.
  
- Example for bargraph indication in the VU mode:
  - Audio operating level = 320 nWb/m for 0 VU
  - Calibration tape = 200 nWb/m
  - Adjust R84 for a time code level of -4 VU (take reading on the VU-Panel)

- Example for bargraph indication in the PPM mode:
  - Audio operating level = 510 nWb/m for 0 dB
  - Calibration tape = 200 nWb/m
  - Adjust R84 for a time code level of -8 dB (take reading on the peak panel).

#### 4.6.5 Adjustment of Time Code Record Level

---

- Load the recorder with little used and erased tape.
- Simultaneously press the keys SET ENABLE and READY of the time code channel (green READY-LED flashes).
- On the alignment keyboard press MANUAL and RECORD LEVEL one after the other.
- Select your TC channel by using CHANNEL ◀ and CHANNEL ▶ until you see ch tc XX in your panel display.
- Start the machine in the RECORD mode.
- By pressing the keys PARAM↑ or PARAM↓ respectively, adjust the record level to a bargraph reading of -10 VU (VU mode) or -16 dB (PPM mode) for recommended level adjustment.
- Press the STORE key.

#### 4.6.6 Alignment of Stray Pick-Up Interference on Time Code Read Unit 1.820.821.00

---

- The stray pick-up compensation is factory adjusted and does not necessarily have to be realigned.
- Switch tape recorder to STOP and SYNC.
- Plug time code read unit onto the extension board and connect pin 9 to pin 21 (ground), because alignment is possible only in the position »wide« of the sync amplifier.
- Connect oscilloscope probe to TP 1 and TP 4 (ground) of the time code read unit.
- Adjust trimmpotentiometer R110 for minimum interference (typically 80 mVpp, maximum 100 mVpp).
- Remove pin 9 to pin 21 connection
- Insert time code read unit without extension board.

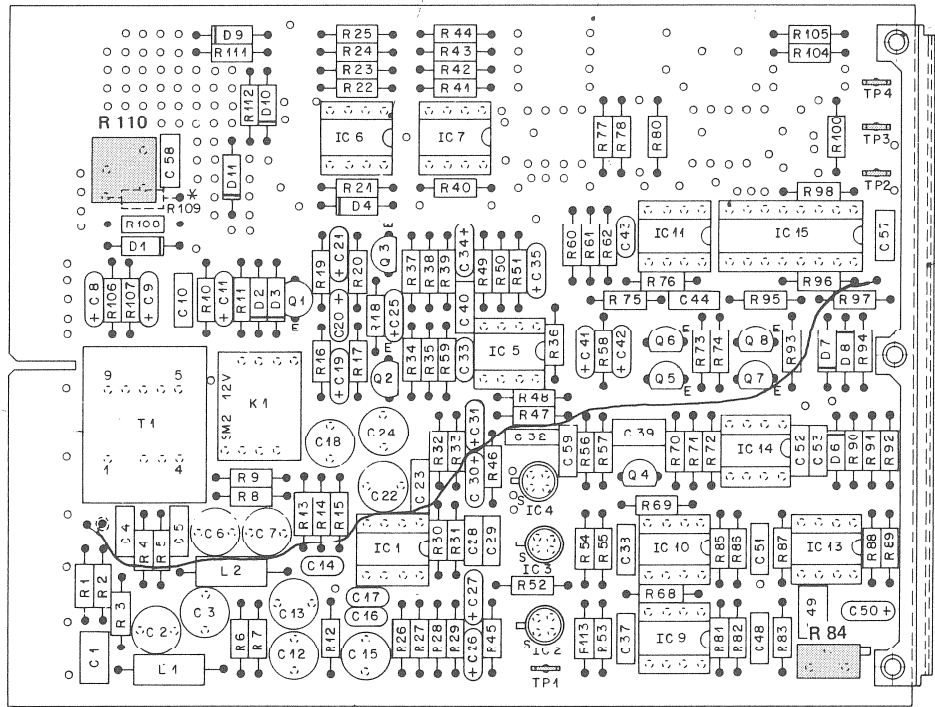

Fig. 4.6.6

## 4.7 External Storage of the Audio Parameters

For copying the audio and tape tension parameters of the RAM to an external storage medium the tape recorder must be equipped with the COMMUNICATION CONTROLLER PCB 1.820.718.

In the following the expressions SAVE (for external storage of the recorder's RAM data), VERIFY (for comparing the externally stored data with those in the recorder's RAM), and LOAD (for writing the externally stored data into the recorder's RAM) will be used.

**Note:** On PCB 1.820.718.00 the LED's SAVE, LOAD and VERIFY do not work. On PCB 1.820.718.01 the LED's SAVE, LOAD and VERIFY do work.

### 4.7.1 Storing the Parameters on Tape (SAVE)

If the recorder receives the command "SAVE" the microprocessor transmits all the stored audio and tape tension parameters in serial format to the connector OUT of the COMMUNICATION CONTROLLER PCB 1.820.718. This output connector is unbalanced, its output level is adjustable (nominal 1 Vpp). The output impedance is switchable between 5 k $\Omega$  (jumper JS1 inserted) and 470 k $\Omega$  (jumper JS1 removed). Output level adjustment: Section 4.8.5.

Three complete copies of the parameters are transmitted each time for safety reasons. However, one correct transmission is sufficient when reloading. The complete save process takes approximately 60 seconds.

#### Procedure:

- Connect one of the line inputs of the tape recorder to the OUT connector on the COMMUNICATION CONTROLLER PCB 1.820.718 (see Fig. 4.7.1).
  - Select tape speed.
  - Mount tape of sufficient length (recording time at least 60 seconds)
  - Press READY button of the desired recording channel.
  - Start recorder in RECORD mode.
  - Press RESET TIMER.
  - Press SAVE on the COMMUNICATION CONTROLLER PCB 1.820.718.
- The LC display on the VU-meter panel indicates:

Data Transmission in Progress  
Please Wait

All VU-meters are disabled, i.e. there is no indication.

Now, the data are written to the tape. When the procedure is terminated, the LC display indicates:

Data Transmission completed

- Press the STORE/START key on the VU-meter panel to clear the display.
- Press ZERO LOC, the tape is rewound to the beginning of the recording.

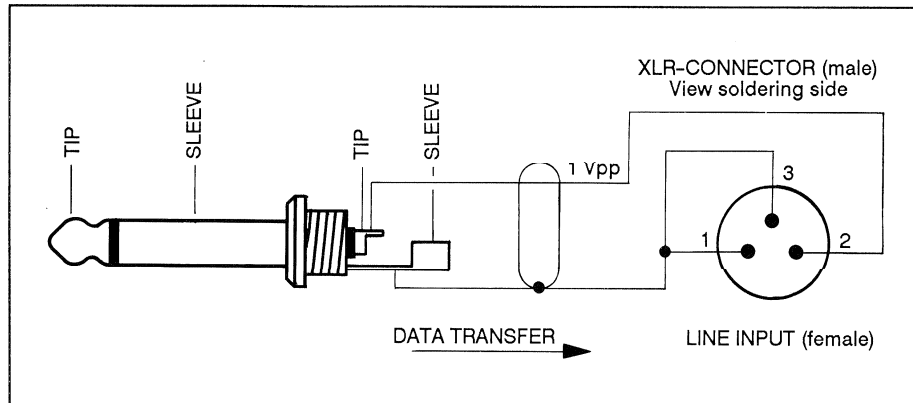

Fig. 4.7.1-1 Adapter cable for 1.820.718.00/81

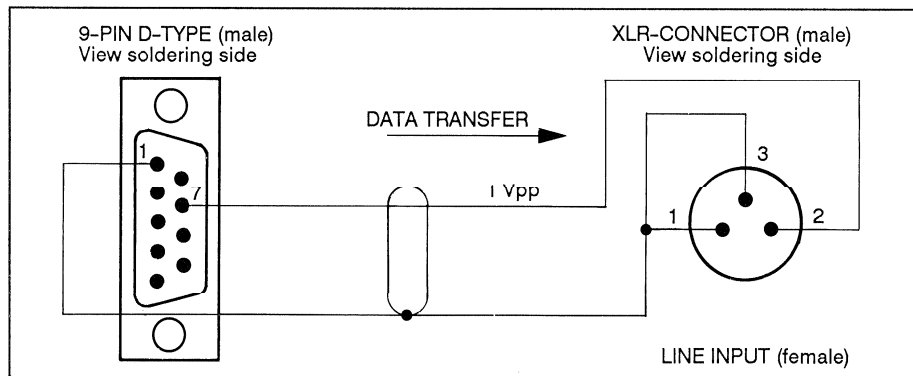

Fig. 4.7.1-2 Adapter cable for 1.820.718.82

## 4.7.2 Comparing the Data on Tape (VERIFY)

If the tape recorder receives the command "VERIFY" the microprocessor receives all audio and tape tension parameters in serial format on the connector IN of the COMMUNICATION CONTROLLER PCB 1.820.718. This input connector is unbalanced. The nominal input level is 1 Vpp, the sensitivity is adjustable. Three complete copies of the parameters are transmitted each time for safety reasons. However, one correct transmission is sufficient when verifying. The complete verification process takes approximately 60 seconds.

**Procedure:**

- Connect the same line output of the tape recorder to the IN connector on the COMMUNICATION CONTROLLER PCB 1.820.718 (see Fig. 4.7.2).
- Select the same tape speed as was used for the SAVE procedure.
- Mount tape with the recorded parameters, and wind to the beginning of the recording.
- Press REPRO button of the channel used for the SAVE procedure.
- Start recorder in PLAY mode.
- Press VERIFY on the COMMUNICATION CONTROLLER PCB 1.820.718.
- Adjust reproduce level: Turn potentiometer LEVEL on the COMMUNICATION CONTROLLER PCB 1.820.718 fully counterclockwise, then clockwise until the LEVEL LED just lights up.
- Wind back to the beginning of the recording, e.g. with LOC START, and select again VERIFY and PLAY.

The LC display on the VU-meter panel indicates:

Verifying data  
Please Wait

Now, the data stored in the RAM are compared with those read from the tape. When the procedure is terminated, the LC display indicates:

Verification successfully  
completed

- Press the STORE/START key on the VU-meter panel to clear the display.

If data transmission errors have occurred (e.g. caused by a transient system voltage failure or unclean soundheads), the following message appears:

ERROR  
verify failed

- Press the STORE/START key on the VU-meter panel to clear the display and repeat the procedure.

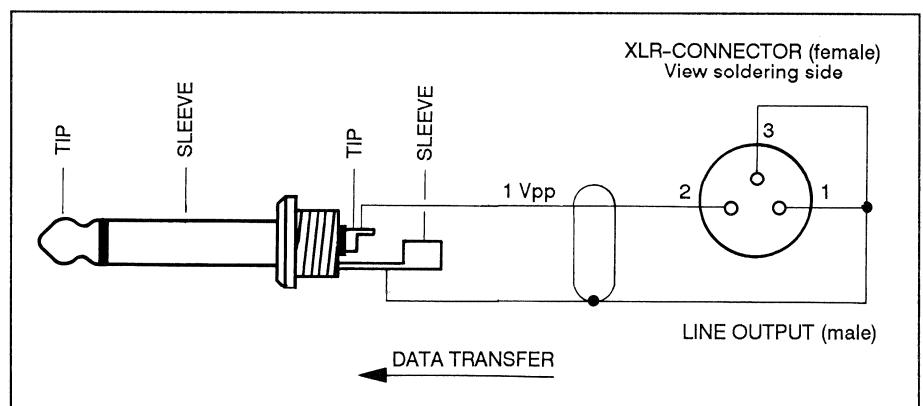

Fig. 4.7.2-1 Adapter cable for 1.820.718.00/81



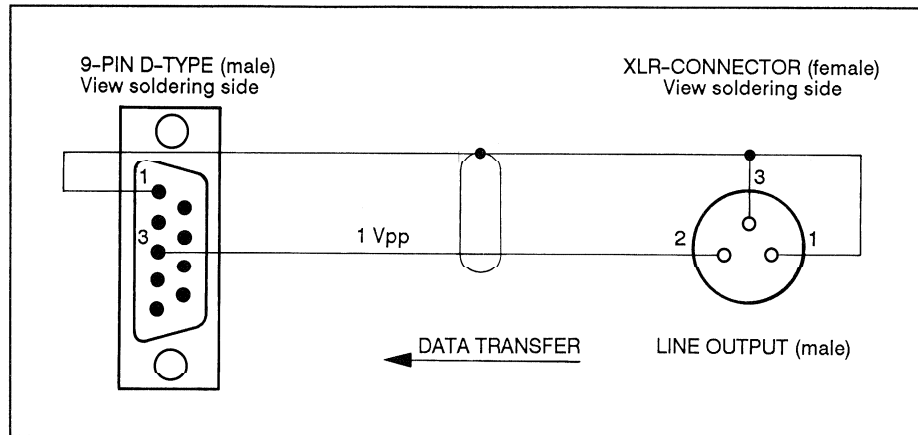

Fig. 4.7.2-2 Adapter cable for 1.820.718.82

### 4.7.3 Loading the Data from Tape (LOAD)

If the recorder receives the command "LOAD" the microprocessor receives all audio and tape tension parameters in serial format and loads them into the RAM. The same cable is used as for the VERIFY procedure.

Generally, the first of the three identical data blocks is sufficient for the LOAD procedure. If errors should occur during LOAD, the microprocessor can read from one of the two following data blocks.

#### Procedure:

- Connect the same line output of the tape recorder to the IN connector on the COMMUNICATION CONTROLLER PCB 1.820.718.
- Select the same tape speed as was used for the SAVE procedure.
- Load tape with the recorded parameters, and wind to the beginning of the recording.
- Press REPRO button of the channel used for the SAVE procedure.
- Start recorder in PLAY mode.
- Press LOAD on the COMMUNICATION CONTROLLER PCB 1.820.718.
- Adjust reproduce level: Turn potentiometer LEVEL on the COMMUNICATION CONTROLLER PCB 1.820.718 fully counterclockwise, then clockwise until the LEVEL LED just lights up.
- Wind back to the beginning of the recording, e.g. with LOC START, and select again LOAD and PLAY.

The LC display on the VU-meter panel indicates:

|   |
|---|
| Data Loading in Progress<br>Please Wait |
|---|

Now, the data read from the tape are stored in the RAM. When the procedure is terminated, the LC display indicates:

|                        |
|------------------------|
| Data Loading completed |
|------------------------|

- Press the STORE/START key on the VU-meter panel to clear the display.

If data transmission errors have occurred (e.g. caused by a transient system voltage failure or unclean soundheads), the following message appears:

|                        |
|------------------------|
| ERROR<br>no data found |
|------------------------|

- Press the STORE/START key on the VU-meter panel to clear the display and repeat the procedure.
- Check with VERIFY if the data are correctly stored in the RAM, refer to Section 4.7.2.

4.8 Programming the Operating Parameters

4.8.1 Program Switches and Jumper Line Amplifier Transformerless; 1.820.715 (ASY3/4/5 GRP1/2 ELM1/6/11/16)

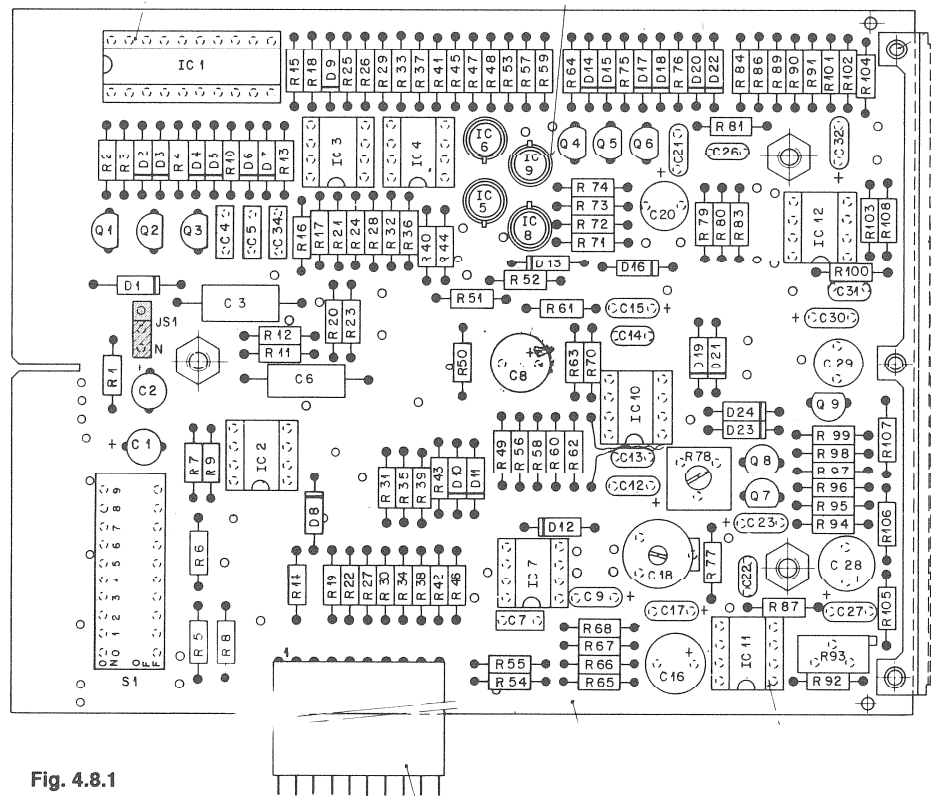
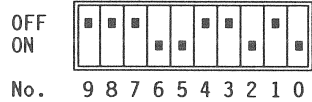

Fig. 4.8.1

Program switches

Standard setting:



Setting for internal NRS:

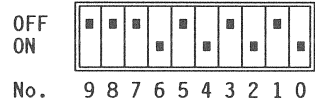

Jumper

Position "N": Low common mode input impedance ( $\approx 10 \text{ k}\Omega$  for every line); standard setting.

Unlabeled position: High common mode input impedance ( $\approx 500 \text{ k}\Omega$  for every line). For special applications only.

4.8.2 Jumper Reproduce Amplifier 1.820.710 (ASY 3/4/5 GRP 1/2 ELM 2/7/12/17)

The SYNC reproduce frequency range can be switched from 12 kHz ("N" = narrow) to 20 kHz ("W" = wide) by means of a jumper.

**Note** Significant record-to-sync channel cross talk must be expected above 12 kHz!

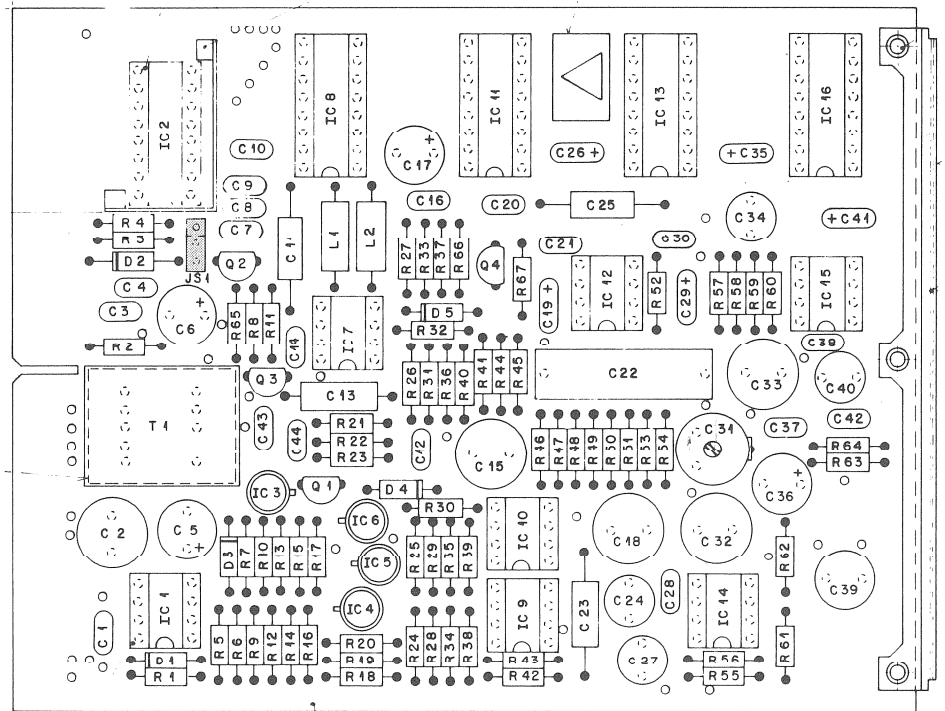

Fig. 4.8.2

4.8.3 Program Switches and Jumpers Panel

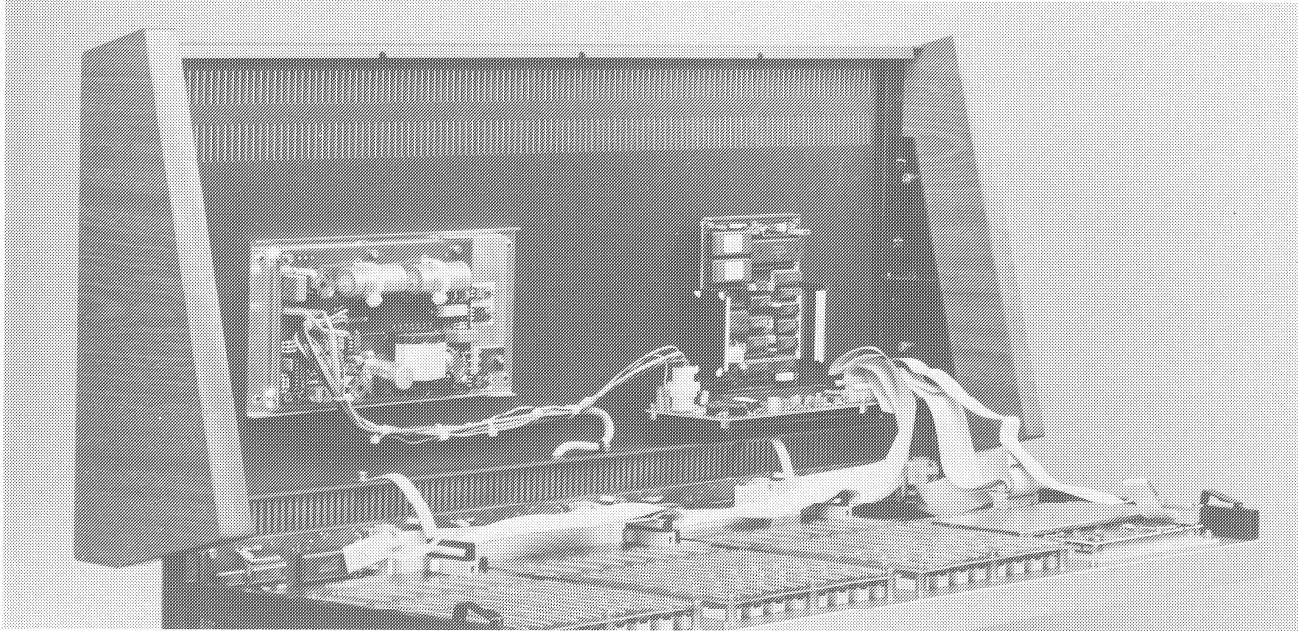

Fig. 4.8.3-1

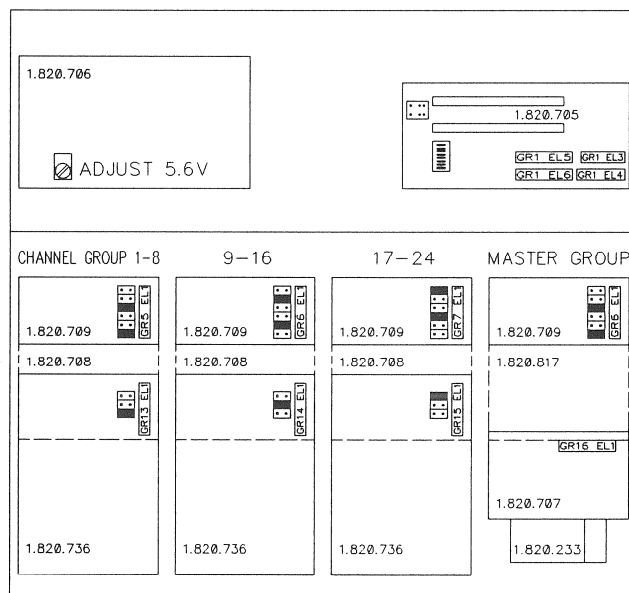

Fig. 4.8.3-2

DIL switch on 1.820.705:

|   |   | Switch no. |   |   |   |   |   |   |             | Description |
|---|---|------------|---|---|---|---|---|---|-------------|-------------|
| 1 | 2 | 3          | 4 | 5 | 6 | 7 | 8 |   |             |             |
| 0 | 1 | 1          | - | - | - | - | - | - | Panel No. 1 |             |
| 1 | 0 | 1          | - | - | - | - | - | - | Panel No. 2 |             |
| - | - | -          | - | - | - | - | - | 0 | Record A    |             |
| - | - | -          | - | - | - | - | - | 1 | Record B    |             |

0 = OFF    1 = ON

#### 4.8.4 Adjustments on Generator Unit PCB 1.820.725; (ASY1 GRP21 ELM22)

The following adjustments need to be performed only after repairs on the PCB have been made.

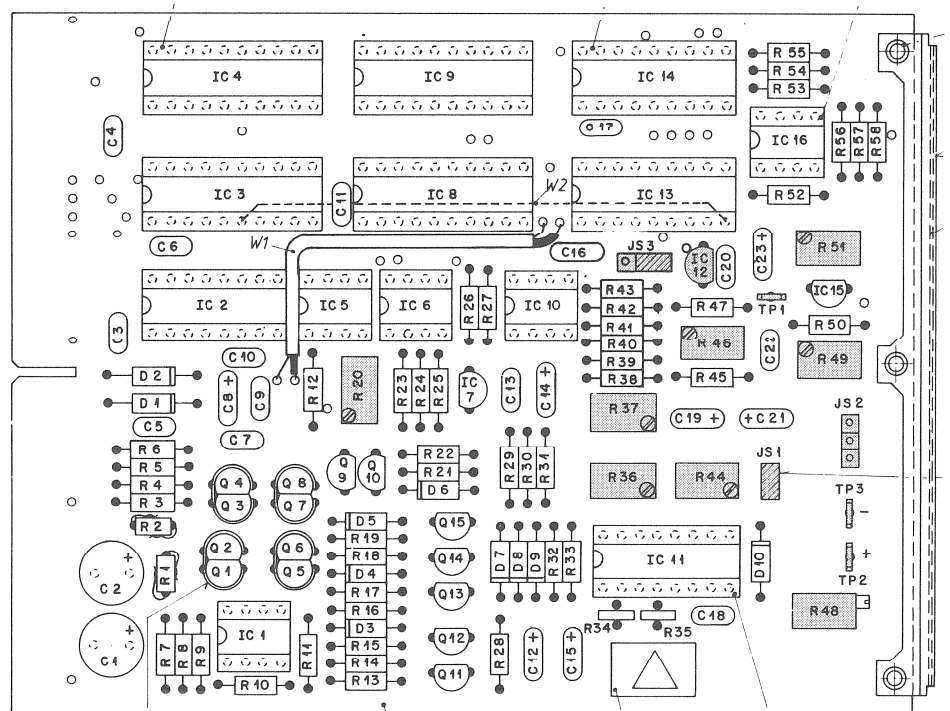

Fig. 4.8.4

#### Adjusting the offset of the ramp generator

- Mount GENERATOR UNIT PCB on the extender board (Order No. 1.820.799.00).
- Connect digital voltmeter to pin13 and to pin12 (ground) of the extender board.
  - For layout No. 1.820.725.11, remove IC12 and short TP1 to ground.
  - For layout No. 1.820.725.11(1), change Jumper JS3 to position "0".
- Adjust DVM reading to  $-100\text{ mV} \pm 1\text{ mV}$  with trimmer potentiometer R20.
- Remove the connection from TP1 to ground and reinsert IC12, or change Jumper JS3 to position "1", respectively.

### Adjusting the reference voltage of the ramp generator

- Mount GENERATOR UNIT PCB on the extender board (Order No. 1.820.799.00).
- Connect DVM to TP1 and to pin12 (ground).
- Adjust DVM reading to  $-10.000\text{ V} \pm 5\text{ mV}$  with R46.

### Checking the ramp generator output signal

- Mount GENERATOR UNIT PCB on the extender board (Order No. 1.820.799.00).
- Connect oscilloscope to pin13 and to pin12 (ground) of the extender board.
- The amplitude of the ramp signal must range from  $-100\text{ mV} \pm 1\text{ mV}$  to  $-10.100\text{ V} \pm 5\text{ mV}$ .

### Adjusting the voltage controlled current source

- Connect digital milliamperemeter to TP2 and TP3 (ground).
- Press the "GEN ON" and the "10 kHz/SWEEP▶" keys on the meter/generator keyboard (on the VU-panel) once.
- Remove jumper JS1, insert it to any position on JS2.
- Measure the current.
- Insert it to the other position.
- Measure the current.
- Compare the two readings and adjust R37 until both jumper positions on JS2 give the same reading on the milliamperemeter.
- Reinsert jumper to position JS1.

### Adjusting the generator frequency

- Connect a frequency counter to pin2 and pin21 (ground) of the extender board.
- Press the "GEN ON" and the "30 Hz/SWEEP▶" keys on the meter/generator keyboard (on the VU-panel) once.
- Adjust the output frequency with R51 to  $30\text{ Hz} \pm 1\text{ Hz}$ .
- Press the "10 kHz/SWEEP▶" key on the meter/generator keyboard (on the VU-panel) once.
- Adjust the output frequency with R49 to  $10.01\text{ kHz} \pm 100\text{ Hz}$ .
- Press the "1 kHz/SWEEP▶" key on the meter/generator keyboard (on the VU-panel) once.
- The counter reading should be  $1.01\text{ kHz} \pm 10\text{ Hz}$ .
- Check the 30 Hz and 10.01 kHz frequencies again.

### Adjusting the harmonic distortion

- Connect an oscilloscope and a distortion meter to pin2 and pin21 (ground) of the extender board.
- Press the "GEN ON" and the "1 kHz/SWEEP▶" keys on the meter/generator keyboard (on the VU-panel) once.
- Adjust HD3 to a minimum with R44.
- Adjust sinewave for optimum symmetry (minimum HD2) with R36.
- The total harmonic distortion (HDTot) must be less than 0.6 %

#### Adjusting the output level, checking the attenuator

- Connect an AF millivoltmeter to pin2 and pin21 (ground) of the extender board.
- Press the "GEN ON" and the "1 kHz/SWEEP▶" keys on the meter/generator keyboard (on the VU-panel) once.
- Adjust output level to 0 dBu = 0.775 Vrms with R48.
- Press "-10 dB" on the meter/generator keyboard (on the VU-panel).
- The output level should be -10 dBu  $\pm$  0.1 dB.
- Press "0 dB" and "-20 dB" on the meter/generator keyboard (on the VU-panel).
- The output level should be -20 dBu  $\pm$  0.1 dB.
- Press "0 dB" on the meter/generator keyboard (on the VU-panel).
- Connect the base of Q12 (or the cathode of D7) via a 4.7 k $\Omega$  pull-up resistor to +15 V.
- The output level should be -6 dBu  $\pm$  0.1 dB.
- Remove the pull-up resistor.

#### 4.8.5 Generator Unit 1.820.825.00

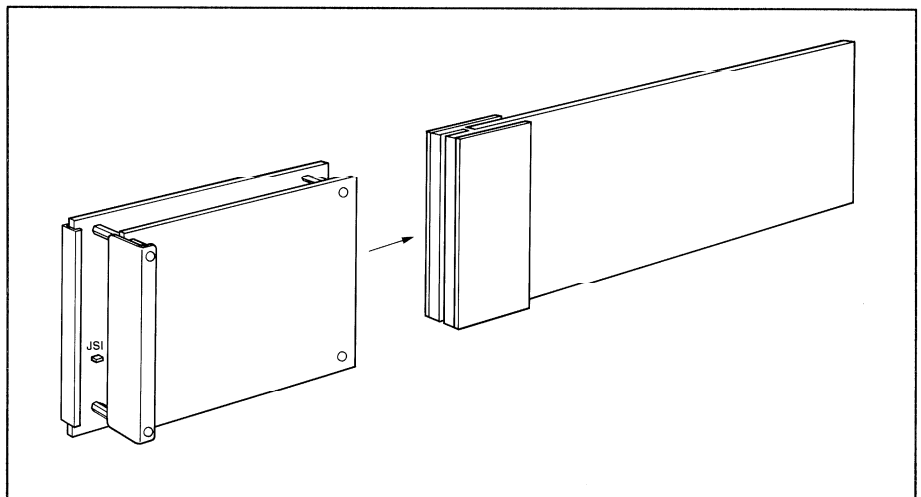

Fig. 4.8.5-1

#### Adjusting of the Ramp Generator

##### A.) Adjusting the offset of the ramp generator

1. Loosen the 4 screws which tighten the "Test Generator Board 1.820.826" to the "Generator Unit 1.820.825".
2. Put the Generator Unit 1.820.825 on an extender board (1.820.799.00).
3. Connect a digital voltmeter (DVM) to pin 13 + pin 12 (GND) of the extender board.
4. Put Jumper J 1 in position "0" (according to schematic diagram).
5. With RA 1 adjust for a voltage of -100 mV  $\pm$  1 mV (negativ voltage!).
6. Put Jumper J 1 back in position "L".



- B.) Adjusting the Reference Voltage of the Ramp Generator**
1. Connect a Digital-Voltmeter to TP2 and PIN 21 (Gnd) on the board 1.820.825 resp. on the extender board.
  2. Adjust with RA2 to a voltage of  $-10,100V \pm 5mV$ .
- C.) Checking the Ramp Generator Output Signal**
1. Connect an oscilloscope to TPI and PIN 21 (Gnd).
  2. The level of the ramp signal must vary between  $100 mV \pm 1 mV$  and  $-10, 100 V \pm 5 mV$  (with the metering switched to PPM).
  3. Assemble both generator board.

### Frequency Adjustment

---

- A)**
1. Put the Generator Unit 1.820.825 on an extender board (Order No. 1.820.799.00).
  2. Connect a frequency meter to pins 2 & 21 (GND) of the extender board.
  3. On the Meter Panel press "GEN ON" and following "GEN FREQ" "↑" until the LC-Display indicates "25.01 kHz".
  4. With RA106 adjust the frequency to  $25 kHz \pm 500 Hz$  on the frequency meter.
  5. On the Meter Panel press "1 kHz"; the LC-Display indicates "1.01 kHz".
  6. With RA107 adjust the frequency to  $1.01 kHz \pm 5 Hz$ .
  7. As both adjustments influence each other, repeat steps 3, 4, 5, 6 until the 2 frequencies are correct.
- B)**
1. On the Meter Panel press "30 Hz"; the LC-Display indicates "0,03 kHz".
  2. With RA 108 adjust the frequency to  $30 Hz \pm 1 Hz$ .
  3. Press "GEN FREQ" "↑" until the LC-Display indicates "0,40 kHz".
  4. With RA 103 adjust the frequency to  $400 Hz \pm 2 Hz$ .
  5. As both adjustments influence each other, repeat steps 1, 2, 3, 4 until the 2 frequencies are correct.
- C)**
1. Check again the frequencies 30 Hz, 1 kHz, 10 kHz.

### Level Adjustment & Harmonic Distortion Minimisation

---

- A)**
1. Connect a distortion meter to pins 2 & 21 (GND) of the extender board.
  2. Press "GEN ON", "1 kHz" and "0 dB".
  3. With RA 109 adjust for minimum 3rd harmonic distortion.
  4. With RA 110 adjust for minimum 2nd harmonic distortion.
  5. The total harmonic distortion must be less than 0,6 % for a signal level of 0 dBu (0,775 V).
- B)**
1. Replace the distortion meter by an AC-Voltmeter.
  2. Select PEAK METERING Mode (PPM) on the A820 MCH.
  3. With RA 105 adjust for a signal level of 0 dBu (0,775 V).
  4. Press "-10 dB":  
The signal level must be  $-10 dBu \pm 0,1 dB$ .
  5. Press "-20 dB":  
The signal level must be  $-20 dBu \pm 0,1 dB$ .
  6. Press "0 dB".
  7. Select VU METERING Mode:  
The signal level must be  $-6 dBu \pm 0,1 dB$ .

## Dolby Tone Generator

---

**Dolby A Reference Tone**      Dolby Tone is 850 Hz signal with a short upward frequency modulation to 935 Hz.

- A)      Checking the Dolby Tone:**
1.    Activate the channels equipped with Dolby A modules by pressing "NRS ON" and "SAFE" simultaneously.
  2.    Connect a frequency meter to pins 2 & 21 (GND) of the extender board.
  3.    Put a jumper into position B of J 101 (according to schematic diagram).
  4.    Press "NRS TONE".
  5.    Check that the frequency is 850 Hz  $\pm$  40 Hz.
  6.    Put the jumper into position A.
  7.    Check that the frequency is in the range between 890 Hz and 950 Hz; It must be at least 50 Hz higher than the frequency measured in step 5.
  8.    Remove the jumper.
  9.    Connect an oscilloscope instead of the frequency meter.
  10.   Check that the total period of the modulation is 750 ms  $\pm$  70 ms.
  11.   Check that the duration of the higher frequency ( $\sim$  935 Hz) is 30 ms  $\pm$  5 ms.
- B)      Checking the level of the Dolby Tone:**
1.    Connect an AC-Voltmeter instead of the oscilloscope.
  2.    Check that the level of the Dolby Tone is -6 dBu, i.e. 388 mV  $\pm$  5 mV <sub>RMS</sub>.
  3.    If necessary, adjust with RA 102.

## Dolby Noise Generator

---

**Dolby SR Reference Noise**      Dolby Noise is pink noise with a 20 ms pause every 2 seconds.

- A)      Checking Dolby Noise:**
1.    Activate the channels equipped with Dolby SR modules by pressing "NRS ON" & "SAFE" simultaneously.
  2.    Connect a frequency meter to pin 21 (GND) and to test point TP 104 (according to schematic diagram).
  3.    Check the period of the pulses:  
It should be 2 sec.  $\pm$  20 ms.  
Adjust with RA 101 if necessary.
  4.    Check the duration of the pulse:  
It should be approx. 20 ms.

- B)      Checking the level of Dolby Noise:**

**Attention:** Noise measurement gives different readings depending on the filtering of the measurement instrument.

1.    Adjust the level of Dolby Noise with RA 104 according to Fig. 1.

Ajustage of the "Generator Unit MCH 1.820.825"

The following adjustments need to be performed only after repairs on the PCB have been made.

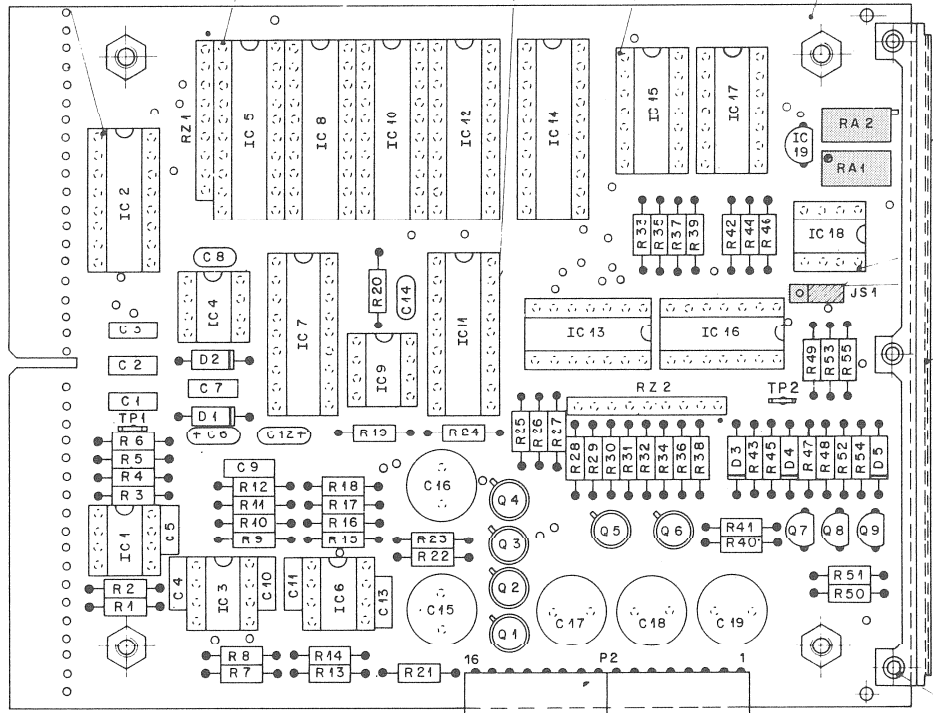

Fig. 4.8.5-2

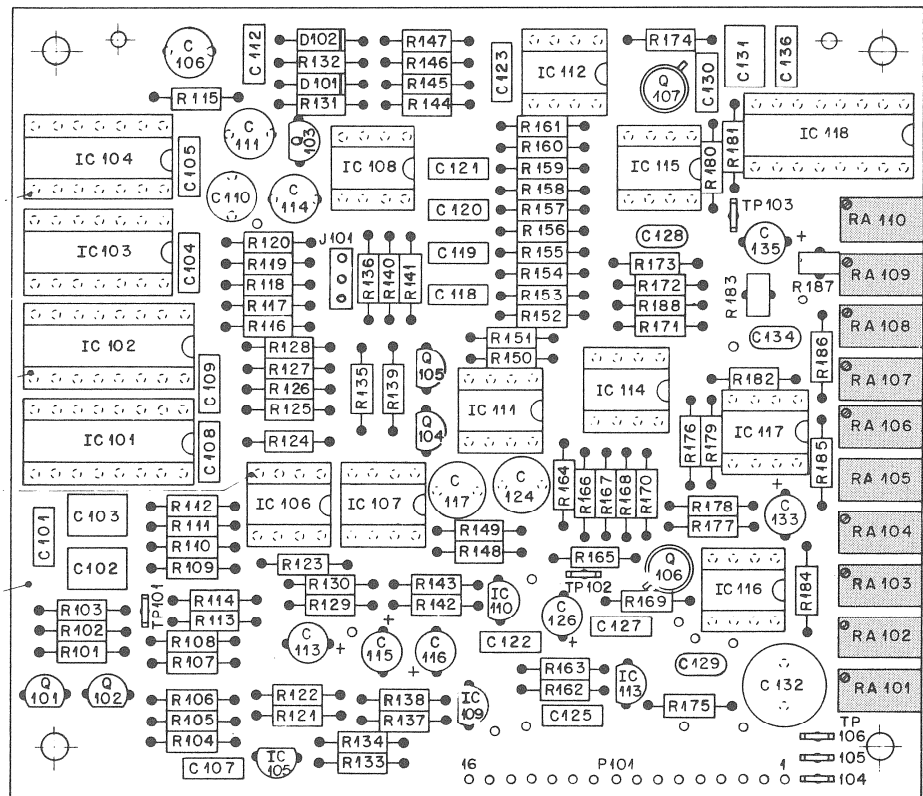

Fig. 4.8.5-3

## 4.8.6 Adjustments on Communication Controller 1.820.718 (ASY1 GRP21 ELM20)

### Preparations

- Set the jumpers according to figure 4.8.6.
- Mount the COMMUNICATION CONTROLLER PCB to an extension board.
- Make a shielded cable of sufficient length with a 9-PIN D-Type connector on one side and a XLR-connector (male) on the otherside. The connectors have to be wired like shown in section 2.

### Adjusting the output level

- Make a connection now from J1 on the COMMUNICATION CONTROLLER to any line input of the machine.
- Connect an oscilloscope to the opened (but connected) XLR-plug → hot.
- Press SAVE on the COMMUNICATION CONTROLLER.
- Adjust output voltage to  $1V_{pp}$  with trimmer-potentiometer R36.

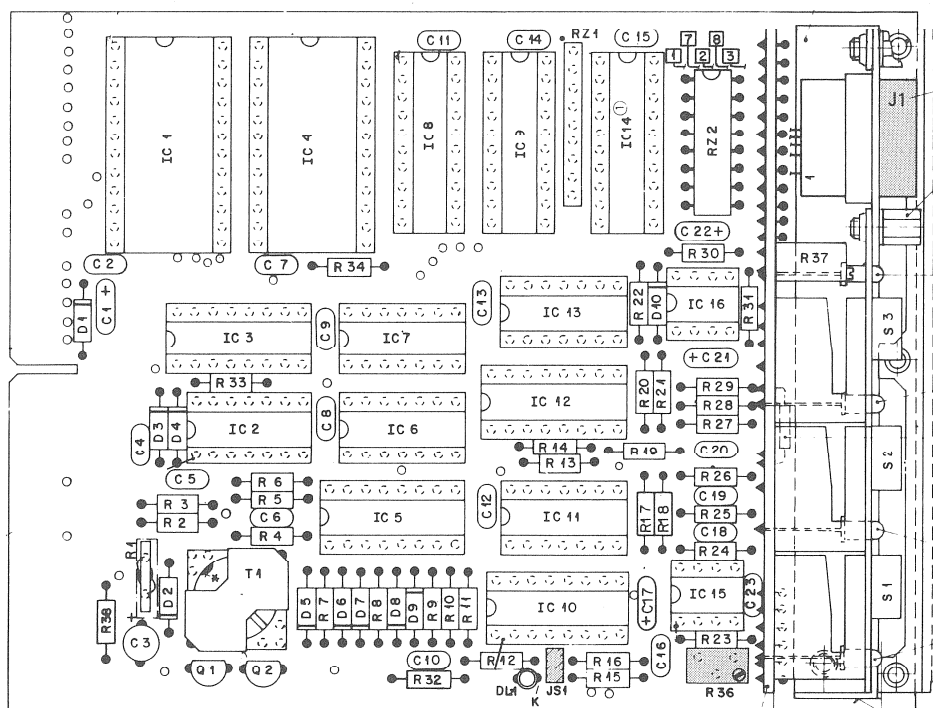

Fig. 4.8.6

4.8.7 Jumper Setting Ext. NRS Controller 1.820.816; (ASY1 GRP21 ELM23)

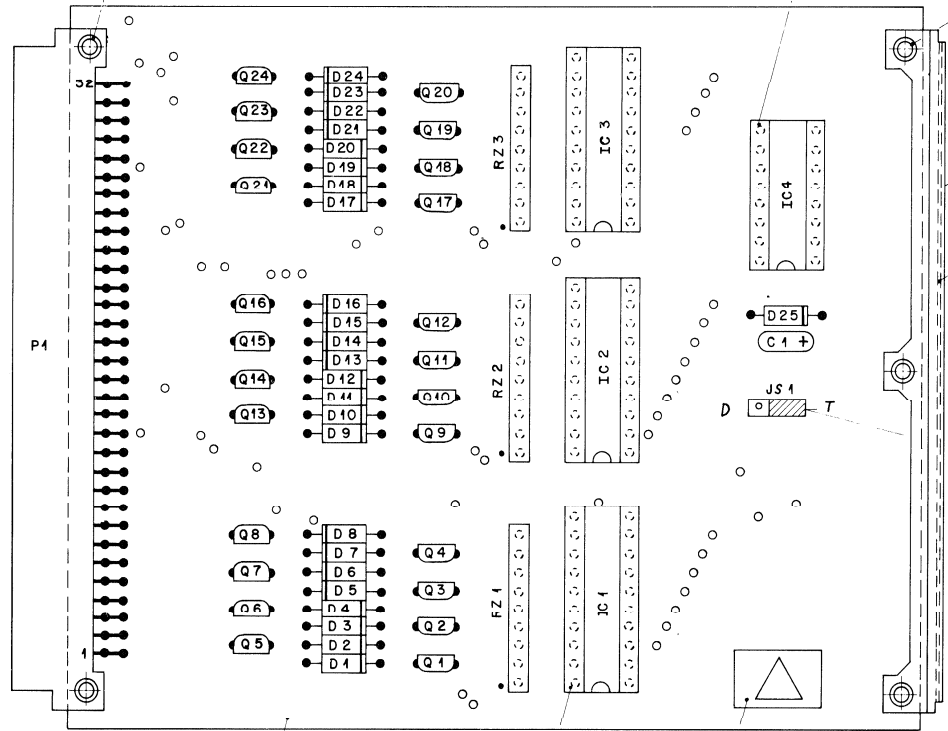

Fig. 4.8.7 T = TELCOM, D = DOLBY

### 4.8.8 Jumper Setting Audio Rack

Standard jumper setting:

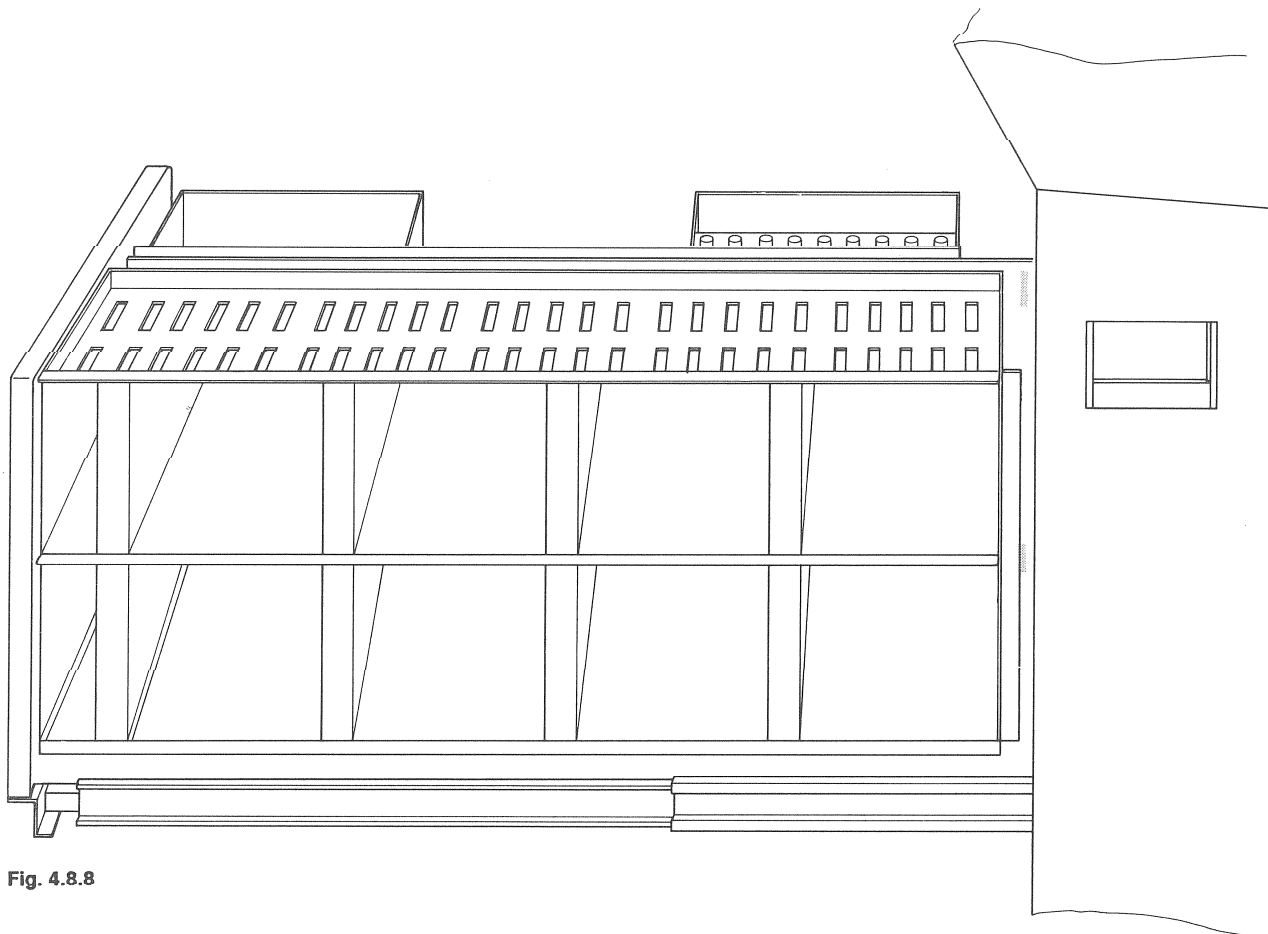

Fig. 4.8.8

## 4.9 Reproduce Preamplifier 8CH 1.820.808.XX

---

The preamp unit essentially consists of eight identical amplifiers. In addition to the active voltage monitoring, the cross talk between adjacent channels is improved by means of a special compensation circuit. The following description relates to CH2 and the adjacent channels CH1 and CH3, and applies analogously to all other channels.

The treble loss in the head is compensated by C21 and the head inductor. R21 dampens the resonance overemphasis at approx 26 kHz. Q21 is degenerative via its emitter, and the filter reduces the interfering 76 kHz component. The gain is determined with R24 and R27, and IC1/2 supplies the amplified low-impedance signal to the output. The supply voltage for Q21 or IC1 respectively is available on the emitter Q22. This voltage is determined by D200. To prevent magnetization of the reproduce head, Q201 activates the negative supply voltage when a positive voltage of approx. 10 V is attained. As a result, current flow through the base of Q21 into the reproduce head is prevented.

The interfering channel cross talk is reduced by feeding an in-phase signal to the inverted inputs of the adjacent channels. The amplitude (0..5V) of the correction signal is controlled by a single potentiometer in the headblock. IC200 together with R202 and 203 convert this voltage to the Y-TLKG signal (-10..+10V) which now determines the gain of the VCAs.

### 4.9.1 Record Amplifier HX PRO 1.820.811.81

---

The RECIN-XY audio signal from the line amplifier is taken via a low pass filter comprising IC9/1. This low pass is laid out for maximum attenuation of the 153.6 kHz erase frequency.

The treble loss caused by the record head air gap is compensated by phase-linear correction elements. The inverting two-fold differentiating circuit (IC13) is followed by the treble control IC11, IC12/1 (record frequency response). A portion of the audio signal is added as a positive inverse feedback via the pluggable ADAPTATION BOARD to the input of AC13/2, in order to improve the steepness of the treble correction. The added components of the corrected record signal are amplified by IC12/2.

The equalization time constant is set with IC7, IC10/1, the record level is set with IC3, IC10/2. The audio parameters stored in RAM are transmitted from the MPU to the corresponding 256-step attenuators.

The 3180  $\mu$ s time constant is connected by EQUAL-01 (-02) via the FET switch IC2.

The record signal is taken to the opamp IC5/2 which functions as a current source.

The AFCSW-01 (-02) signal (AUDIO FREQUENCY CURRENT SWITCH) switches the recording current via Q1. The record and bias current are added via T1. The two HF filters with L3 and L4 prevent the insertion of the bias frequency into the other circuit elements. The bias current is derived via the series resonant circuit comprising T2; as a result a closed bias circuit is established via the two windings of L1 and the winding of the record head.

**Supplement to HX-PRO**

The HX-PRO (R) system reduces the bias dynamically and frequency-dependent under conditions with high AF amplitude. The HX-PRO can be switched on and off with the CA-RSW01 (01) signal. If HX-PRO is enabled (CA-RSWXY = 1), Q2 blocks and the treble content and amplitude of the record signal are analyzed with R30 and C15. The AF signal is impedance converted by IC6/2 and full-wave rectified with the aid of IC4/1, D5, and D6. The added signals of the bias (via R11) and the rectified AF signal (via R13/R15) are smoothed by a peak rectifier and taken to the bias control (BIAFB signal).

(Also refer to the description of the HF Driver 1.820.813.xx)

**4.9.2 HF Driver 1.820.813.XX**

The erase and bias currents are prepared on the HF amplifier.

The 307.2 kHz quartz reference TA-CLK of the microprocessor is prepared by IC12/1/2 and divided down to 153.6 kHz by IC13 (DUAL JK NEGATIVE EDGE-TRIGGERED FLIP-FLOP).

The latter's outputs are connected to the HF driver IC15.

The erase and bias output stages are controlled via the windings of transformer T2.

The selection for reading the supply voltage values for the erase current is performed with IC7 (OCTAL D-TYPE FLIP-FLOP) and IC8 and the bias current (in 256 steps; data lines CA-DATA-0...7). The DC voltage value for the bias current is defined via IC 1/1 based on the values stored in RAM. The attenuator IC 1/2 for ERASE functions analogously. IC7 decodes also the switching commands for enabling the erase and bias current. CA-GAFE = 0 activates IC1.

The DC voltage values defined by the microprocessor are switched on or off by Q8 (erase current) and Q4 (bias current). IC9/1 and IC 3/1 respectively shapes the on/off edges in such a way that click-free drop-in and drop-out is achieved. IC9, Q3 and IC3, Q7 provide the supply voltages to the corresponding power output stages. These supply voltages are proportional to the required output currents. B6 or Q10 monitor these currents and switch off the HF driver IC15 via the collectors R73/R71 and the comparator IC14/1.

The standby signal TA-ACT-01 (-02) is connected via IC14/1. This signal indicates to the microprocessor that channel 1 or 2 is ready. TA-ACT also checks that the record amplifier is plugged in.

The erase current is amplified by Q12 and Q9 and transmitted via T1 to the output.

IC11, IC10 and relay K1 switch the erase current on or off.

The bias current is amplified by Q14 and Q13 and taken to the output.

The control loop for controlling the bias current is returned via IC5/2 to the control element IC5/1. This control is also active in HX-PRO mode and reduces the bias current via BIAFB if the treble output level is very high (also refer to Record Amplifier 1.820.811.XX). IC4 together with C4 and R8 are responsible for the soft start of the HX-PRO circuit when record is activated.



## 4.9.3 Meter-Panel

---

The meter panel contains a separate microprocessor system.

All connections to the peripheral modules are centrally arranged on the BASISBOARD 1.820.705-00:

Connector J1 links the microprocessor unit 1.820.782 and supplies all signals of the external microprocessor system (8x data, 3x address plus corresponding control signals); connector J2 is not used.

The signals of the external MP system are prepared on the basis board for controlling the display and the keyboard bus:

|            |  |
|------------|--|
| <b>IC5</b> | Data output to the display bus (T-BGD 0 to 7)                          |
| <b>IC6</b> | Selection of the display mode (T-BGSL 1 to 3)                          |
| <b>IC7</b> | Write signal display bus (T-BGWR)                                      |
| <b>IC2</b> | Data output to the key board LCD bus (T-KBD 0 to 7)                    |
| <b>IC3</b> | Selection of the keyboard modules (T-Mod 1 to 7)                       |
| <b>IC4</b> | Selection of the row of keyboard keys (T-KBA 0 to 2)                   |
| <b>IC1</b> | Reading of the keyboard keys (T-KBD 0 to 7) byte-per-byte for each row |

### Other peripherals

- Panel bus (biphase, balanced, 76 kBaud) with bus driver IC13, Q1, Q2 and receiver IC14 with electric isolation (transformer T1). Send/receive changeover with IC13.
- Panel address selectable with DIL switch SW1, read in with IC12. (For address assignment refer to the table in the panel).

## 4.9.4 Bargraph Module 1.820.736

---

The display columns (5x10 LEDs + 3 LEDs) are controlled by the individual drivers (IC2 to IC9) in time division multiplex (8x8)  
6x8) 5x10=50 VU LEDs  
1x2)  
1x3 SCALE LEDs

The 8 columns of each group are selected with IC1.

## 4.9.5 Keyboards 1.820.708/817

---

## 4.9.6 Keyboard Driver 1.820.709

---

The LEDs of the display columns LDCLNX and the rows LDRWX are controlled by the driver IC3 in time division multiplex (6x8). The selection of each group of eight is determined by the corresponding jumper position JS1.

The keys are scanned for enable input (E) row by row in time division multiplex (5x8) by IC1, the outputs of the keys (open collector) are read column by column KCLNX by IC2.

#### 4.9.7 Audio Alignment Keyboard 1.820.707

---

The LEDs of the display columns LDCLXX and the rows LDRWX are controlled by the driver IC1 in time division multiplex (6x8).

The keys are scanned for enable input (E) row by row (KRWX) in time division multiplex (5x8) by IC3, the outputs of the keys (open collector) are read column by column KCLMX by IC2.

## 4.10 Time Code Line Amplifier 1.820.820.00

---

This circuit establishes the connection between the "Time Code Read Unit" (TAPDI-XY), the "NRS Interface" (INPDI-XY for signal recording and MONIT-XY for signal level indication) and the "Line input and Output" (LINFA-XY, LINFB-XY / LOUFA-XY, LOUFB-XY).

Before evaluation these signals must be processed. The recorded signal must have a standard leading and trailing edge shape. By contrast the output signal must always have approximately the same shape (crosstalk at high frequencies). The inputs and outputs are designed as transformerless differential circuits.

With a control logic the various amplifiers can be activated in accordance with the operating mode (record or reproduce), and the signal for the level indication can be selected (CA-EQLTC for the tape signal or the differential output signal in INPUT mode).

### 4.10.1 Time Code Read Unit 1.820.821.00

---

In conjunction with a time code read unit three different read modes are possible, depending on the application:

- 1) **Reproduce:** The time code signal is read by the read head and subsequently taken to a preamplifier and a filter amplifier. The 153.6 kHz frequency as well as the treble are suppressed.
- 2) **Sync mode, normal speed (max. triple the reproduce speed):** The time code signal is read by the record head and taken directly to an amplifier that is identical to the reproduce amplifier (high-impedance input).
- 3) **Sync mode, high speed:** The time code signal is read by the record head and taken to a wideband amplifier with differential input (low-impedance input).

After one of these paths the signal is split: One portion is conducted via a compressor, a peak detector, and a comparator for maintaining a perfect rectangular signal shape for the time code line amplifier, while the other portion, derived via two integrators, is an approximately square-wave signal for level indication.

### 4.10.2 Generator Unit MCH 1.820.725.00

---

The test and alignment signals are produced by the function generator IC 11. The signal balance and shape can be adjusted with R36 and R44 respectively.

An adjustable current source (DAC IC 14) generates the required frequencies as well as the wobble voltages from a fundamental frequency (30 Hz, 1 kHz, 10 kHz) which can be selected up to the maximum frequency of 25 kHz.

The 0 dB level is adjusted with R48. Three additional levels can be defined: -6 dB in the VU meter setting, -10 dB and -20 dB with the corresponding keys. The board also contains a ramp generator for producing a reference level (REFLEV) for measuring the audio signal level.

Finally this board is equipped with an output amplifier for the signal from the frequency generator and the reference signal from the ramp generator.

|              |              |   |
|--------------|--------------|---|
| 1.820.725.00 | <b>R 20:</b> | Offset voltage of the ramp generator (-100 mV)                                  |
|              | <b>R 46:</b> | Max. ramp level (-10, 125 mV)   |
|              | <b>R 49:</b> | Reference level for the current source of the function generator, 1 kHz setting |
|              | <b>R 51:</b> | Current source offset compensation, 30 Hz setting                               |
|              | <b>R 37:</b> | Alignment of the current source gain  |
|              | <b>R 44:</b> | Alignment of the distortion minimum (K3)  |
|              | <b>R 36:</b> | Balance alignment (K2)  |
|              | <b>R 48:</b> | Alignment of the signal level   |

#### 4.10.3 Generator Unit MCH 1.820.825.00 + 1.820.826.00

Same as 1.820.725.00,  
plus:

- 1 Noise generator (pink noise) (IC 111...113)
- 1 Pulse generator (IC 101...106)
- 1 Dolby tone generator (IC 107...110)

#### 1.820.826.00

**Noise generator:** This is an integrated circuit (IC 112) for generating white noise, and an RC filter for conversion to pink noise. The signal level can be adjusted to 388 mV (average value through a 2-pole Butterworth band filter 31.5...20 kHz) by means of potentiometer RA 104.

**Impulse generator:** Generates 20 ms pulses in intervals of 2 seconds (RA 101) and can be synchronized with the TD-SYNC signal from one or several noise reduction boards Dolby SR/A cat 300, provided this synchronization signal is available within 3 seconds from the start of the generator.

If several Dolby boards generate non-synchronized pulses, all of them are available on the generator output. This must be prevented, otherwise an undefined Dolby noise will be generated.

**Dolby tone generator:** This is a 2-tone generator whose main frequency of approx. 850 Hz is modulated to approx. 940 Hz during approx. 30 ms in intervals of approx. 750 ms. The level can be aligned to 388 mV with the potentiometer RA 102.

#### 1.820.825.00

**TONGEN:**

- 1. Dolby noise:** This is a combined noise and pulse generator. The pink noise called Dolby noise is interrupted every 2 s for a duration of 20 ms.
- 2. Dolby tone:** The signal originates directly from the Dolby tone generator.
- 3. Sine wave:** The signal originates directly from the frequency generator. The desired option can be selected with the keys GEN ON, NRS TONE and SR/A via a corresponding logic circuit.
  - The Dolby noise reduction system (SR/A cat 300) is automatically detected at power on with the three connections TD-SRAA, TD-SRAB, and TD-SRAC.
  - This board is also equipped with an output amplifier for the noise generator.

|                |   |   |
|----------------|---|---|
| 1.820.825.00   | <b>RA 1:</b>  | Ramp generator offset voltage (-100 mV) |
|                | <b>RA 2:</b>  | Ramp peak value (-10, 100 mV)           |
|                | <b>RA 106:</b>  | Frequency alignment 25 kHz) (33 nF)     |
|                | <b>RA 107:</b>  | Frequency alignment 600 Hz)             |
|                | <b>RA 108:</b>  | Frequency alignment 30 Hz) (680 nF)     |
|                | <b>RA 103:</b>  | Frequency alignment 550 Hz)             |
|                | <b>RA 109:</b>  | Alignment to min. distortion (K3)       |
|                | <b>RA 110:</b>  | Signal balance alignment (K2)           |
|                | <b>RA 105:</b>  | Signal level alignment                  |
|                | <b>RA 102:</b>  | Dolby tone level alignment (-6 dBu)     |
| <b>RA 104:</b> | Noise level alignment (-6 dBu, mean value, 2-pole Butterworth band-pass filter 31.5 Hz...20 kHz RA 101 : "Nick" pulse period alignment (2 s). |   |

### 4.10.4 Switching & Metering Unit 1.820.716.00

---

Permits changeover of the direct output signal (INPDI.XY) or the internal generator signal (TONGEN) to the record outputs (RECIN-XY) and to the line outputs (INPAD-XY), feeding of the tape signal to the line amplifier input as well as the measurement of the audio level (MONIT-XY) after the VU-meter or PEAK meter in comparison to a reference signal (REFLEV). For the audio signal the gain factor (METER ON key) can be varied to obtain a higher resolution on the peak meter (30/70% of Vss).

When the machine is switched on, the data and address bus is digitally checked for any short circuits and line interruptions.

### 4.10.5 Internal NRS Controller 1.820.815.00 + 1.820.867.00

---

- Same as 1.820.716.00 plus:
- Utilization of a noise reduction system (NRS) via an interface circuit
  - Function control for the following internal noise reduction modules:
    - Dolby A cat 22
    - Dolby SR cat 280
    - Telcom c 4DM
    - Telcom c 4E
  - Adaptation and alignment of the input and output level of the noise reduction system (NRSin-NRSout) with variable gain amplifiers (DAC IC16) for preserving the compatibility between the various noise reduction systems as well as different record levels.

#### 4.10.6 Internal Controller SR/A 1.820.824.00

---

- Same as 1.820.815.00 plus:
- Function control for the noise reduction system DOLBY SR/A cat 300
  - Audio level alignment (MONIT-XY) with potentiometer R44 for measurement purposes so that the indication can be individually adjusted for each channel.
  - With a digital test, the presence of a time code unit at power ON can be checked, and the time code read unit can be switched to wide band mode during operation.