

# INSTRUCTION BOOK



STUDER

*C37*

Edition 1  
April 1961  
(All respective correspondence  
under this reference please)

# Index

	Page
A) TECHNICAL DATA . . . . .	3
B) <u>OPERATING INSTRUCTIONS</u>	
General . . . . .	5
1. Installation . . . . .	5
2. Power connection . . . . .	5
3. Audio Connections . . . . .	5
4. Remote control . . . . .	6
5. Changing adapters for cores or reels . . . . .	6
6. Threading the tape . . . . .	7
7. Push-button controls . . . . .	7
8. Turning on the recorder . . . . .	8
9. Speed selection . . . . .	8
10. Turning off the recorder . . . . .	8
11. Fast wind, forward and reverse . . . . .	8
12. Playback, reproduce . . . . .	8
13. Record . . . . .	8
14. The stop button . . . . .	8
15. Editing and cueing . . . . .	9
16. The timer . . . . .	9
17. The tape cutter . . . . .	9
C) <u>THE TAPE TRANSPORT MECHANISM</u>	
1. The head mount . . . . .	12
2. The brakes . . . . .	12
3. The tape tension balance . . . . .	13
4. Fly wheel (impedance drum) . . . . .	14
5. Tape lift mechanism . . . . .	14
6. The capstan assembly . . . . .	14
7. The tape cutter . . . . .	16
8. The tape timer . . . . .	16
9. Power supply for the tape transport mechanism . . . . .	16
10. The relay box . . . . .	16

D) <u>THE AMPLIFIER SECTION</u>	
1. Record amplifier . . . . .	18
2. Oscillator . . . . .	19
3. Reproduce amplifier . . . . .	20
4. Rectifier unit . . . . .	20
5. Regulating unit for DC plate and filament voltages . . . . .	21
E) <u>ALIGNMENT AND PERFORMANCE CHECKS</u>	
1. Reproduce amplifier alignment . . . . .	22
2. Record amplifier, bias adjustment . . . . .	22
3. Record level calibration and distortion measurement . . . . .	23
4. Record azimuth adjustment . . . . .	23
5. Overall frequency response . . . . .	23
6. Noise measurement . . . . .	23
7. Erase efficiency . . . . .	24
8. Wow and flutter . . . . .	24
9. Miscellaneous measurements . . . . .	24
F) <u>MAINTENANCE SCHEDULE</u> . . . . .	24
G) <u>PARTS LIST</u> . . . . .	27

ADDITIONAL APPENDIX (if necessary)

SCHEMATA

*For additional questions please write to*

**EMT WILHELM FRANZ GMBH**  
 LANDSTRASSE 85 - WETTINGEN (AG) SWITZERLAND

E-104.01-Si  
 Printed in Germany

## A Technical Data

Dimensions:	Chassis length 25.8" (655 mm) depth 20.7" (525 mm) Height under table top 13" (330 mm) Height above table top, highest point 4.13" (105 mm)
Weight:	approx. 170 lbs. chassis, complete with amplifiers
Power requirement:	220 V $\pm$ 10% 50 cycle, approx. 250 VA or 110 V $\pm$ 10% 60 cycle, " 250 VA.
Tape speed, nominal:	15 ips and 7 1/2 ips, push-button selected with simultaneous record- and replay equalization change.
Tape speed, absolute:	$\pm$ 2% of nominal
Tape slip:	max. 0.1% from the start of a 12 inch. reel down to a diameter of 2,4 inches
Wow and flutter, overall:	$\pm$ 0,075% peak to peak 15 inch. $\pm$ 0,1% peak to peak 7 1/2 inch. This will correspond to less than 0.1% rms total wow and flutter, if measured with a meter which is calibrated to read the rms value of sine wave flutter.
Starting-time:	less than 0.2 sec. to reach a motion stability of $\pm$ 0.2%
Stopping-time from regular forward speed:	approx. 0,1 sec.
Stopping-time from fast wind:	2 sec.
Rewind-time:	max. 2,5 minutes for 3.300 ft of standard tape
Reel dimensions:	max. diameter 12 inch. Interchangeable adapters for European core DIN 45515, international plastic reel, or NAB hub.
Tape timer:	99 minutes 59 seconds driven by tape, accuracy better than 0,2%. 0,2% at all running speeds, including fast wind.
Input:	0.7 to 7.00 V adjustable, balanced impedance greater than 20 kilohms between 40 to 20000 cps.
Output:	0.7 to 7.00 V adjustable, balanced, designed to work into loads from 200 to 600 ohms (max. +24 dbm into 200 ohms). Effective output impedance less than 20 ohms from 40 - 20000 cps.
Frequency response:	+1 db to -2 db, from 30 - 15000 cps at 15 ips from 40 - 15000 cps at 7 1/2 ips
Overall distortion:	less than 2% at a tape flux of 200 milli Maxwell at 1000 cps
Signal-to-noise ratio:	(measured with General-Radio Distortion and Noise Meter type 1932-A)  The signal-to-noise ratios indicated are derived by computing the difference in decibels between the absolute noise levels measured and the signal level obtained by reproducing a 400 cps tone which has been recorded to a level of 3% harmonic distortion. Scotch tape type 111-A has been used in this test.  If recordings are to be made to a tape-flux of 200 milli Maxwell only, a reduced overall signal-to-noise ratio must be expected. The ratios measured will vary depending on the brand of tape used. The loss will be 4 db on the average.
Tape speed:	15 ips      7,5 ips
Ratio of playback-amplifier, machine at stand-still:	66 db      66 db
Ratio overall:	62 db      60 db
No weighted readings.	



Erase efficiency:	better than 75 db, measured with narrow band-pass filter or wave - analyser
Record and playback heads:	Vacodur (Alfenol)
Erase head:	Ferrite
Oscillator:	80 kc, one frequency only
Running hour counter:	6 digit counter, counts only when capstan motor powered
Stray field:	max. 50 milligauss at a distance of 2,0 inch. from the equipment
Tubes:	Playback amplifier: 3 x E 188 CC 1 x E 283 CC
	Recording ampl. : 2 x E 188 CC
	Oscillator: 3 x E 188 CC
	Power supply for amplifiers: 1 x E 130 L
	1 x E 283 CC
	3 x 85 A2
	1 x OC 27
	Silicon-Rectifiers
	Power supply for tape transport: 1 x ASZ 15
	Silicon-Rectifiers.

## B Operation

The STUDER C 37 Magnetic Tape Recorder is an instrument of the most up-to-date design-conception and can be regarded as setting a mile-stone in the art of magnetic sound recording. The unit may be used for manual and remote control.

With it, a piece of equipment has been created which complies - as far as possible - with today's national and international standards and recommendations. Where in applying these a contradiction results, such flexibility has been maintained that the user may decide and choose his preferred method of operation.

Due to the novel "building-block principle" used in the construction of the recorder, any part of it can be exchanged within minutes and the machine becomes thus available for almost uninterrupted service.

Carefully dimensioned electrical parts and the sound mechanical construction ensure highest operating reliability.

However, to maintain the performance of the recorder at the highest standard which the manufacturer has set, regular checks will be essential.

It is therefore recommended to read this service and operating manual carefully and to follow the instructions given herein, should adjustment and realignment become necessary.

You are then assured to obtain always recordings of the very highest professional quality.

### 1. INSTALLATION

The recorder STUDER C 37 is shipped from the factory, after thorough inspection and testing and is ready for operation without further preparation. Each machine is supplied with its final test report and should perform according to the data indicated. However, before connecting to the power line make certain that all tubes are seated properly in their sockets and check plug-in amplifiers, oscillator and power-supply for being pushed home into their respective receptacles. When lifting the top plate, observe that all cables can move freely while remaining connected to their mating receptacles.

Important: The recorder STUDER C 37 in its standard version is built for operation on 220 V, 50 cycle power-lines only. For all other voltages step-up or step-down transformers of proper power handling capacity must be used.

### 2. POWER CONNECTION

The recorder connects to the power line from the power receptacle (type Feller 8343 je) via the cable plug (type Feller 8343) which is supplied with each machine.

### 3. AUDIO CONNECTIONS

The record amplifier input is adjustable to accept input levels from 0.7 - 7.00 V. The input is balanced and its impedance is greater than 20 kilohms. The input line connects to the cannon-receptacle with socket insert (type XLR-3-32) via the mating cannon plug (type XLR-3-11C) which is supplied with each machine.

The playback amplifier output is adjustable for output levels 0.7 - 7.00 V and designed to work into loads from 200 - 600 ohms (max. +24 dbm into 200 ohms). Effective output impedance less than 20 ohms, balanced. The output line connects to the cannon receptacle with pin insert (type XLR-3-31) via the mating cannon plug (type XLR-3-12C) which is supplied with each machine.

Connection of plugs: 1 ground, shield; 2 and 3 input and output respectively.

#### 4. REMOTE CONTROL

A remote control box may be connected to the 11-pole amphenol chassis receptacle at the rear of the machine. For normal operation without remote control facility the 11-pole amphenol plug (type 86-CP-11) with strap between pins 3 and 4 which is supplied with each machine, must be inserted into this receptacle, as otherwise all running modes of the recorder are disabled.

The remote control box contains the same five push-buttons which are installed on the left hand side of the machine. The circuit diagram is indicated in Figure 1.

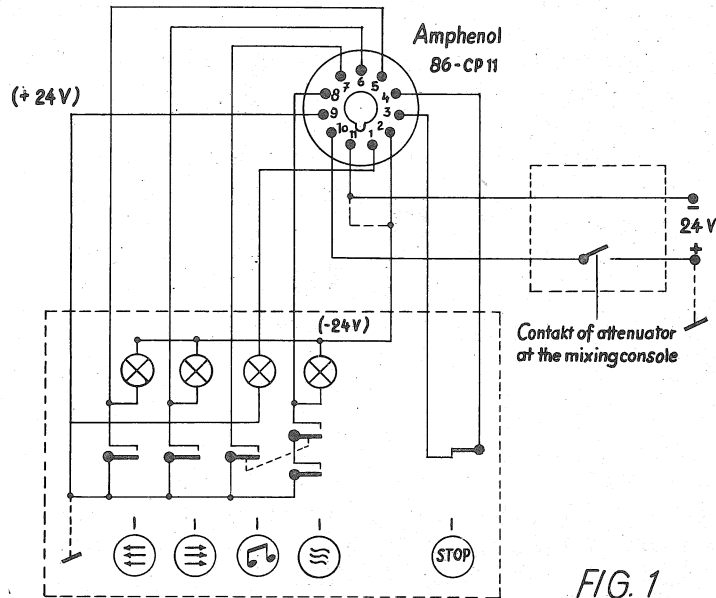

FIG. 1

Furthermore, it is possible to control the playback of the machine by means of a contact which is automatically operated on opening the relative attenuator. Thus it is possible to start the recorder by opening the attenuator, and to stop it by closing the latter one.

#### 5. CHANGING ADAPTERS FOR CORES OR REELS

**Important:** Always make certain that only reels or cores of the same type and dimension are used on each spindle of the wind-motors. Excessive loop formation during tape start or torn tapes due to incorrect breaking may otherwise result. Providing this is always observed it is possible to use reels or cores down to a minimum diameter of 2,35" (60 mm), as the supply tension is held constant by the electronic tape tension control irregardless of reel diameter. The recorder is supplied with two pairs of adapters.

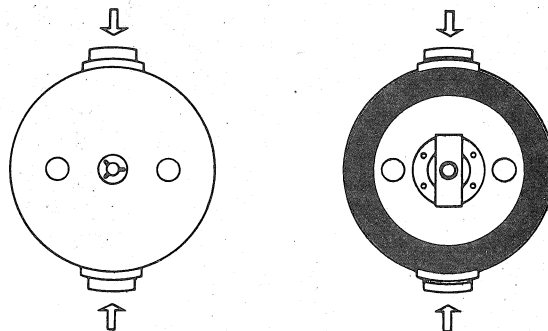

FIG. 2

One set for the EIA 5" and 7" plastic reels and one set for European cores as per standard designation DIN 45515. A bakelite adapter which fits over the latter permits the use of NAB 10 1/2" reels. To exchange adapters, simply depress the locking bars with thumb and index finger and lift the adapter from its spindle. When inserting an adapter push firmly downwards, making certain that both bars lock properly.

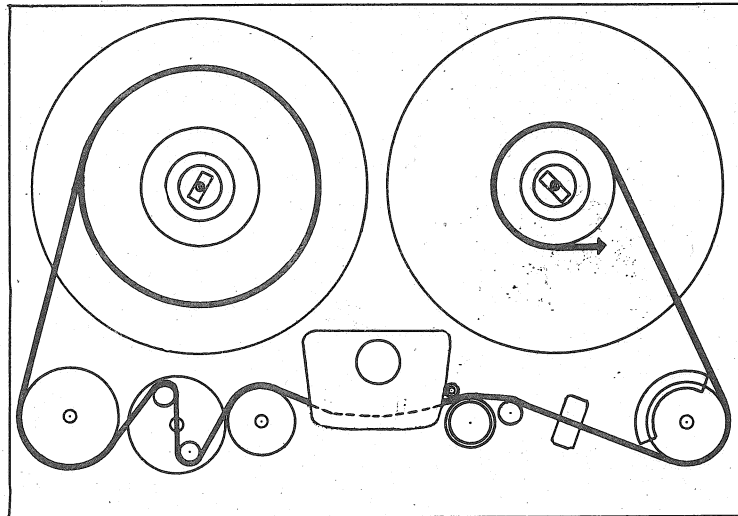

FIG. 3

#### 6. THREADING THE TAPE

The recorder has international layer position (inside). Thread the tape as shown in Figure 3. With the tape threaded on the recorder, it must be wound on to the take up side, tight enough to move the tape tension control idlers approximately half-way in to their working range. The capstan drive motor is thus being switched on and the machine is now ready for instantaneous starts.

Tapes that were used for recording on another recorder with layer outside, have to be twisted by 180° before the first guide-roller, for playback on the STUDER C 37.

#### 7. PUSH BUTTON CONTROLS

The convenient to operate push buttons are separated into two groups. On the right hand side are the controls for speed selection which simultaneously serve to turn on the electronics of the recorder, the off-button and the cutter control. The push buttons for controlling all running modes are grouped on the left hand side. The operating condition selected is indicated by internal illumination of the corresponding buttons, all symbols on the push buttons are clear and self-explanatory.

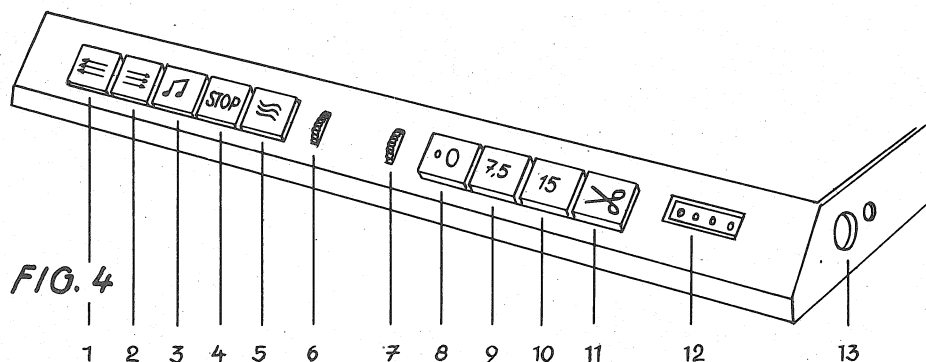

FIG. 4



## 8. TURNING ON THE RECORDER

The power switch is interlocked with the two push buttons for speed selection (9 and 10). By depressing one of the two buttons marked 7.5 or 15, power for all amplifiers and the tape tension control circuit is being turned on. As the warm-up time for all tubes is appr. 30 sec., record or playback operations should not be commenced with before this period of time has elapsed.

## 9. SPEED SELECTION

To change from one tape speed to another, the recorder has to be stopped and the tape tension idlers must be returned into their resting position. Depressing the button 7.5 (9) or 15 (10) selects capstan motor windings and amplifier equalisation appropriate to the tape speed to be used.

## 10. TURNING OFF THE RECORDER

To avoid accidental interruptions during operation, the off-button (8) is effective only when the recorder has been stopped and the tape tension idlers have returned into their resting position. Depressing the off-button disconnects power from all parts of the recorder.

## 11. FAST WIND, FORWARD AND REVERSE

The push buttons for fast forward (2) and reverse (1) are so designed that depending on how they are operated, two winding speeds can be selected. Depressing either of them only slightly the tape will move at a relatively slow speed and remain in contact with the heads. After releasing the button, the brakes become effective and will stop the recorder immediately. This form of operation greatly facilitates all editing work. Is the tape to be rewound, the respective button needs to be depressed fully, after which the tape gets lifted off the heads and rewinding takes place at maximum speed. Switching into fast forward or reverse speeds from any regular running mode is possible without fear of damage to the tape.

## 12. PLAYBACK, REPRODUCE

The push button "reproduce" (5) remains functional only as long as the tape tension idlers are in their operating position. With the tension idlers in their operating position, the capstan drive motor is running before the tape is set into motion and an extremely short starting-time is thereby achieved. If tape tension is lost due to excessive loop formation, end of reel or tape breakage, a safety switch is actuated by the returning tension idlers and all tape motion will be stopped. For optimum signal-to-noise-ratio during playback, the mu-metal shield should be moved over the playback head by operating the right hand knurled disc (7), located between the two groups of push buttons.

## 13. RECORD

To record the playback (5) and record (3) buttons have to be depressed simultaneously. Accidental erasure of any recorded programme is thus less likely, as the record button is electrically interlocked with the playback button so that it alone cannot set the recorder into motion. All other functions on the equipment are similar to those described in the previous paragraph.

## 14. THE STOP BUTTON

Operating the stop button (4) interrupts all running modes of the recorder. Once it has been depressed the tape has to come to a complete stop (2 seconds) before any other function can be selected. This delay feature avoids loop formation and tape breakage, as a rapid change from fast wind into regular forward speed is impossible.

## 15. EDITING AND CUEING

Searching for any specific point or selection in a recording, as well as indexing the tape, as in editing or cueing, is performed either as described under: fast wind or, if the tape is being wound already at maximum speed, by rotating the left hand knurled disc (6) which lowers the tape back on to the heads. During recording the same knurled disc will - when rotated - lift the tape off the erase and record heads, thus enabling the operator to continue a recording at a given cue. A dash pot connected to the tape lift mechanism slows down the return of the tape which results in a minimum of transients during this operation.

## 16. THE TIMER

The four didget timer is driven by the moving tape via the large guide-roller on the right hand side. Airpassages in the face of this idler which is in contact with the tape, prevent the formation of an aircushion, ensuring an accuracy of this counting device which is better than 0.2% at all speeds including fast wind. The timer indicates in minutes and seconds up to 99 min. 59 sec. for the tape speed of 15 ips. At the speed of 7 1/2 ips the values indicated have to be doubled. The reset-lever (13) is accessible through a slot on the right hand side of the recorder. In order to count only from the beginning of the recording, the reset-lever has to be kept depressed exactly until that moment when the sound comes up.

## 17. THE TAPE CUTTER

Of great assistance in all editing work will be the electrically operated cutter in conjunction with the calibrated markings on and around the large guide-roller on the right hand side of the recorder. When editing and cutting, the disc on which the tape tension idlers are mounted is to be rotated counter clock-wise until it detents and locks into this end position, thereby eliminating any flexible element in the tape path. This lock is automatically released after one of the push buttons "playback" or "fast wind" is being depressed. For cutting it is suggested to procede as outlined below:

1. Locate the point at which the cut is to be made, following the instructions given under the heading fast wind, or for more accurate control, by turning the reels by hand.
2. After the point for cutting has been located, it is to be left over the playback head while the right hand guide roller is being turned by hand until one of the red-green dividing lines is aligned with the mark M on the plexiglass dial.
3. The tape is now to be moved by rotating the take-up reel in counter clock-wise direction, so as to align the same red-green dividing line with the mark S. This will place the point at which the tape is to be cut above the cutter. After simultaneously depressing the buttons stop (4) and cutter (10), the electrically operated scissors emerge to cut the tape at the desired spot. Analogue to this and under consideration of the direction of rotation as engraved on the plexiglass dial a once located spot on the tape can be placed over the erase or record head. If the tape is to be cut manually, this has to be done using the same angle. The built-in scissors may be used, too, for this purpose.

*Studio Tape Recorder C 37*

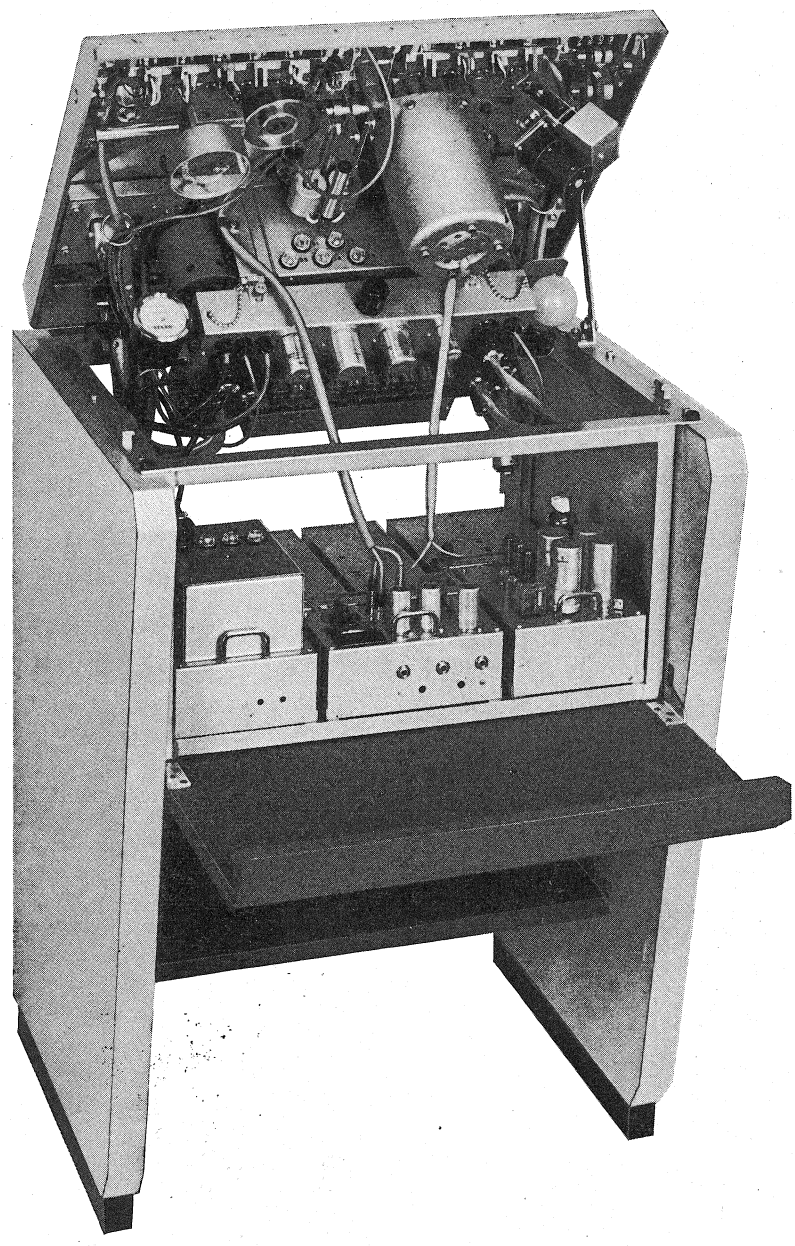

# The Main Parts and Assemblies

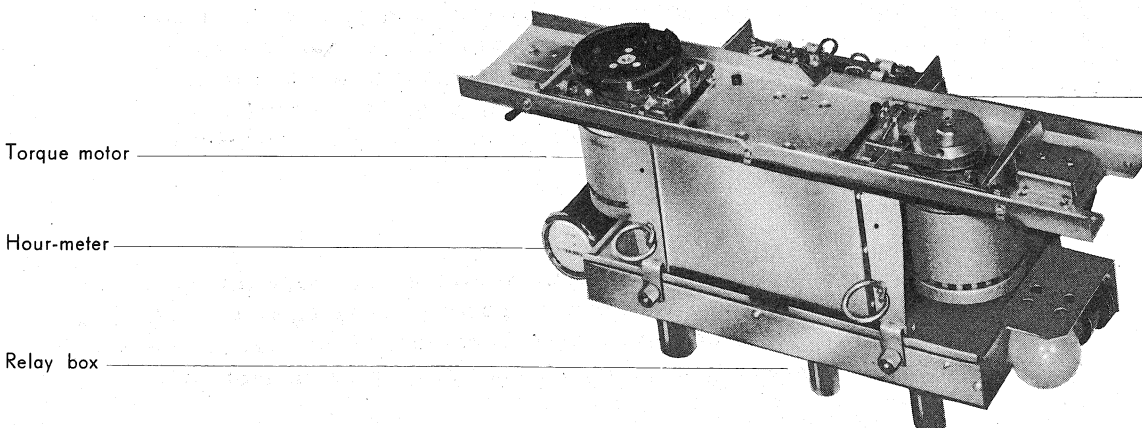
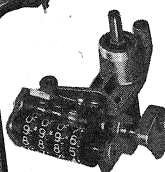
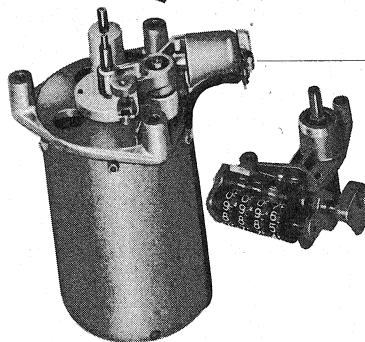
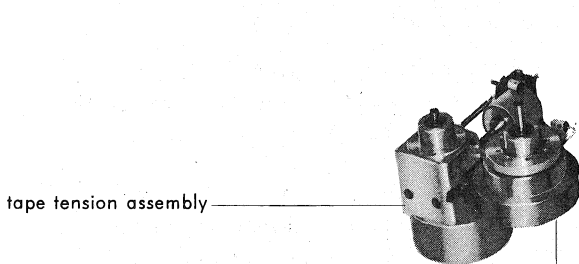
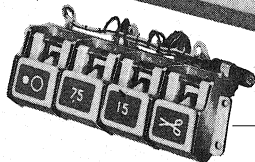
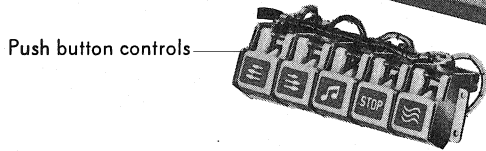
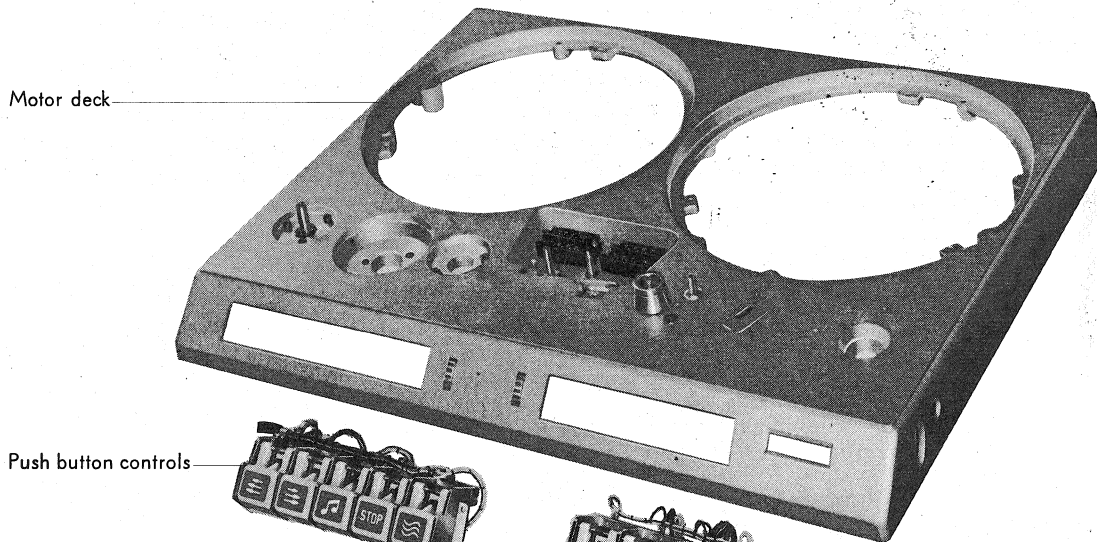
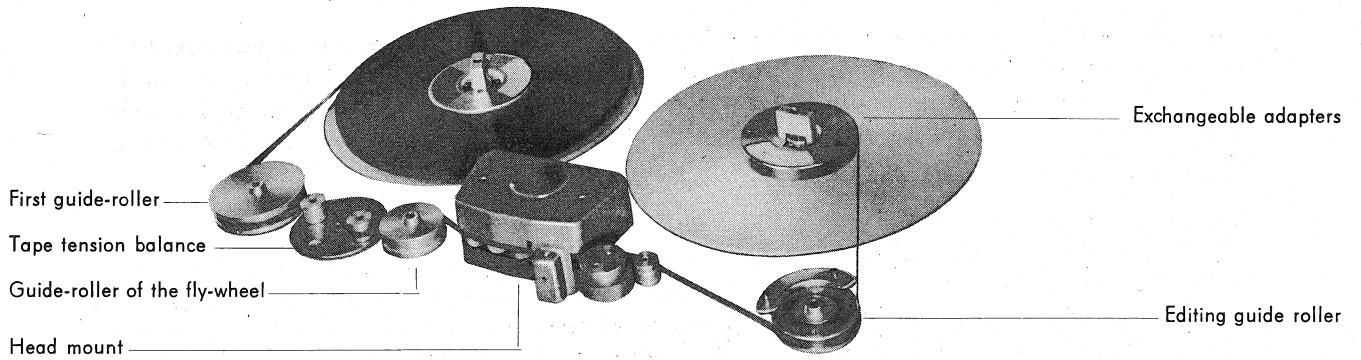



## C Tape Transport Mechanism

The motor deck can be lifted after depressing the recessed buttons on each side of the plate. Counter balanced cushioning devices aid in raising the heavy part of the recorder. All parts and assemblies are then easily accessible for maintenance and repair. With the top plate raised, the recorder remains operational and all routine tests may be carried out in this position.

### 1. THE HEAD MOUNT

The head mount is made of heavy cast-aluminium. In it the magnetic heads are mounted in such a way that rotational adjustment around their horizontal and vertical axis is possible. Record- and playback-head are shielded by mu-metal cups. Guide pins at both ends of the head mount eliminate any lateral weave of the tape. There are no rollers or other devices guiding the tape between the heads, as these would be superfluous due to the excellent motion characteristic which has been achieved by keeping the distance between the flywheel pulley, heads and capstan respectively as short as possible. The electrical connections to the electronics of the recorder are via Tuchel-connections which are installed - well shielded - in the head mount, with ample reserve contacts so that stereophonic and multitrack heads can be accommodated.

To remove the head-mount from the recorder, access to the three allen-head mounting screws can be gained by removing the head assembly cover plate. After the mounting screws have been removed, the whole head block may be lifted off.

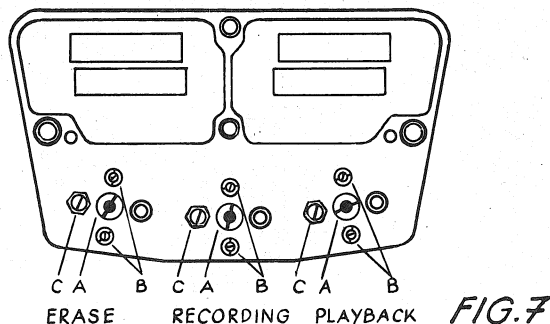

Each head is held in place inside the head-mount by five screws, figure 7. The screw designated A in the illustration is the actual mounting screw and its removal will be necessary only when the corresponding head is to be exchanged.

To align the face of each head parallel to the passing tape (indicated by even wear pattern) the setting of the two screws marked B have to be altered. However this adjustment has been made very carefully at the factory and no realignment should be necessary.

**Important:** Always switch off the power to the recorder before removing or reinstalling the head block, as an unbalanced pulse may be generated during this operation and cause the heads to become magnetised. Before installing the head block, it is recommended to always demagnetise all heads in a gradually diminishing AC-field by the use of a demagnetising coil which is commercially available for this purpose.

### 2. THE BRAKES

For maintaining proper tape tension, the recorder has two brake systems which are independent of each other. During any regular running mode, braking is purely electrical by a DC current through the supply motor whose magnitude is controlled by the tape tension balance. Mechanical brakes are used to stop the wind motors

and to hold the turntables in their stopped position. High reliability of the mechanical brakes is assured by the use of nylon brake linings which have a very high life expectancy and by the relatively low brake tension required for proper operation.

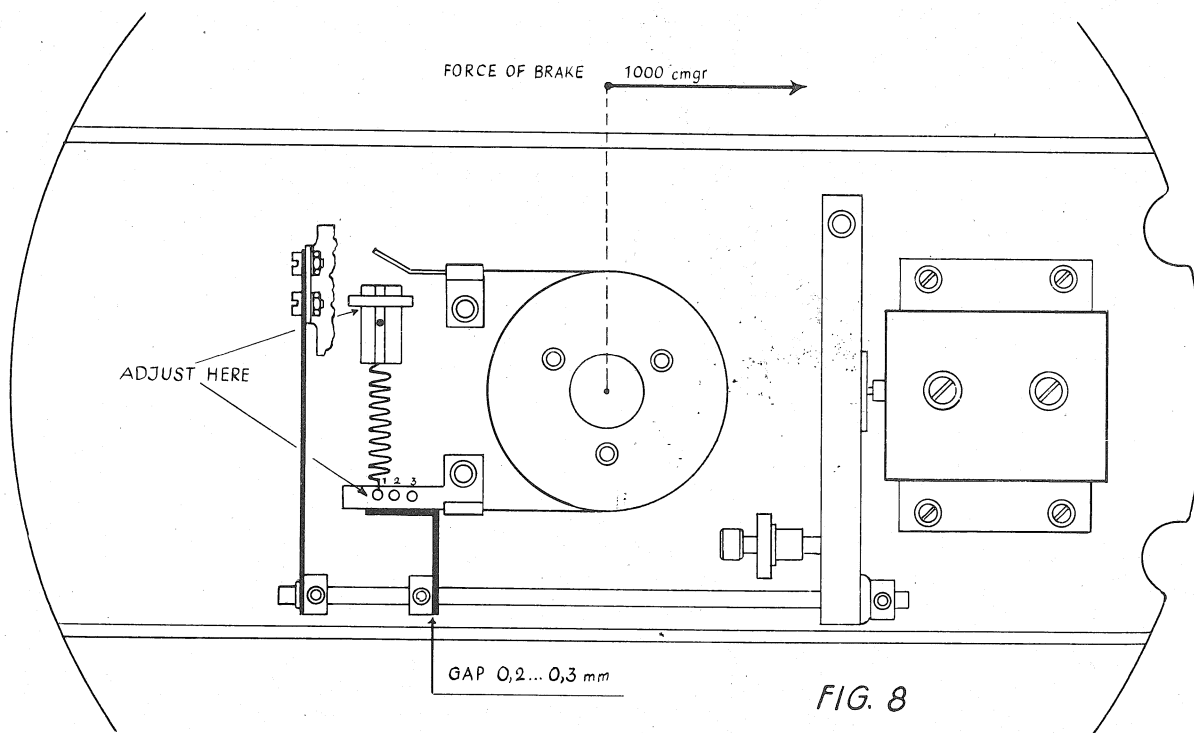

Should any adjustments on the mechanical brakes become necessary, the turntable and the underlying dust-covers which are held by three screws have to be removed. Both brakes - supply as well as take up side - have to be adjusted to a brake tension of 14 inch/ozs. (1000 cmg). This measurement is best being taken by placing a plastic reel onto the turntable and attaching a spring scale to the reel at a point appr. 2" from the spindle centre. The tension measured in the direction indicated in the illustration should then be appr. 7 ozs. Coarse adjustment can be made by connecting the spiral spring to either one of the three holes in the bracket. For fine adjustments rotate the red knurled nut.

The second adjustment screw is for setting the brake clearance and travel of the brakelever. It has been set at the factory and should be left undisturbed.

### 3. THE TAPE TENSION BALANCE

A characteristic feature of all professional STUDER tape recorders is the tape tension balance. With this device tape tension is being kept constant during all running modes irregardless of speed or spool or reel diameter. In addition to this, it reduces greatly any jerks caused by splices or other similar irregularities in the tape. It incorporates a safety switch which stops all tape motion after the end of a reel or in the event of excessive loop formation or tape breakage. For editing and cueing operations the tension balance can be locked into a "out-of-use" position, from which it is automatically released after the recorder is started in the record or playback mode.

Tape tension during regular forward speeds is a appr. 2 - 3 ozs. (60 - 80 gr) which is determined by a spring in the tension balance and no adjustment should be required.

In the event that the safety switch is not operating properly, it can be readjusted by slight rotational movement of the potentiometer housing of the tension balance. With the tension balance in its resting position, the wiper of the potentiometer has to bridge the first and second contact. In this position the push buttons 7.5 and 15 must remain operative. The adjustment screw of the double draw spring is set correctly when the safety switch operates with no tape in the recorder. As long as tape is threaded on the machine, it must not be actuated irregardless of recorder manipulation.

A dash-pot connected to the tension balance suppresses any possibility of mechanical oscillations. With a knurled adjustment screw on the left hand end of the dash-pot, the damping action can be varied and it should be set for full return travel of the tension balance in slightly less than one second.

When exchanging the tension balance, proceed as follows:

- a) always disconnect dash-pot first!
- b) remove electrical connections,
- c) remove socket screw from top centre of idler plate and carefully lift the plate,
- d) remove the three screws holding the complete tape tension assembly to the top plate and withdraw it from the machine.

#### 4. FLY-WHEEL (impedance drum)

The fly-wheel pully is located between tape tension balance and the head mount. The fly-wheel is effective during record and playback operations only. To reduce tape friction, the fly-wheel is electro-magnetically lifted and thus disengaged from the pully shaft during any fast wind mode, or when the recorder is at stand-still.

#### 5. TAPE LIFT MECHANISM

The tape can be lifted off the heads in two steps. For this, a pin, linked to two solenoids, is fitted between the erase and record heads. In one position the tape is lifted off the erase and record heads while remaining in contact with the playback head, in the second position it gets lifted off all three heads. To prevent abruptness in the return of this lift mechanism, its movement is damped by a dash-pot. The action of this dash-pot can be varied with a knurled disc forming the bottom of the cylinder.

To permit coarse monitoring of the contents of a tape during fast wind, the tape should clear the playback head by appr. 20 thou. (0.1 mm) only. This distance can be adjusted on the threaded linkage between solenoid and tape lift mechanism.

#### 6. THE CAPSTAN ASSEMBLY

The tape is driven by the capstan which is connected without intermediate gearing via an elastic coupling to the 6-12 pole hysteresis synchronous motor. Two motor windings can be selected corresponding to the tape speed to be used. A heavy cylindrically shaped fly-wheel connected to the capstan shaft, encloses the drive motor, forming one unit which is totally encased. Mounted on the same frame is the capstan solenoid and capstan idler. An opening in the motor deck permits adjustment of the capstan idler pressure which is to be appr. 3 lbs. (1,3 kg). To measure the capstan idler pressure, the drive motor circuit has to be interrupted by removing the fuse S 2. After depressing the push buttons "playback" readings can be taken using a spring scale attached to the idler shaft in line with the idler movement. When making this measurement, it is important that the solenoid has bottomed, as only then the true pressure of the idler, as caused by the pressure spring, is being read.

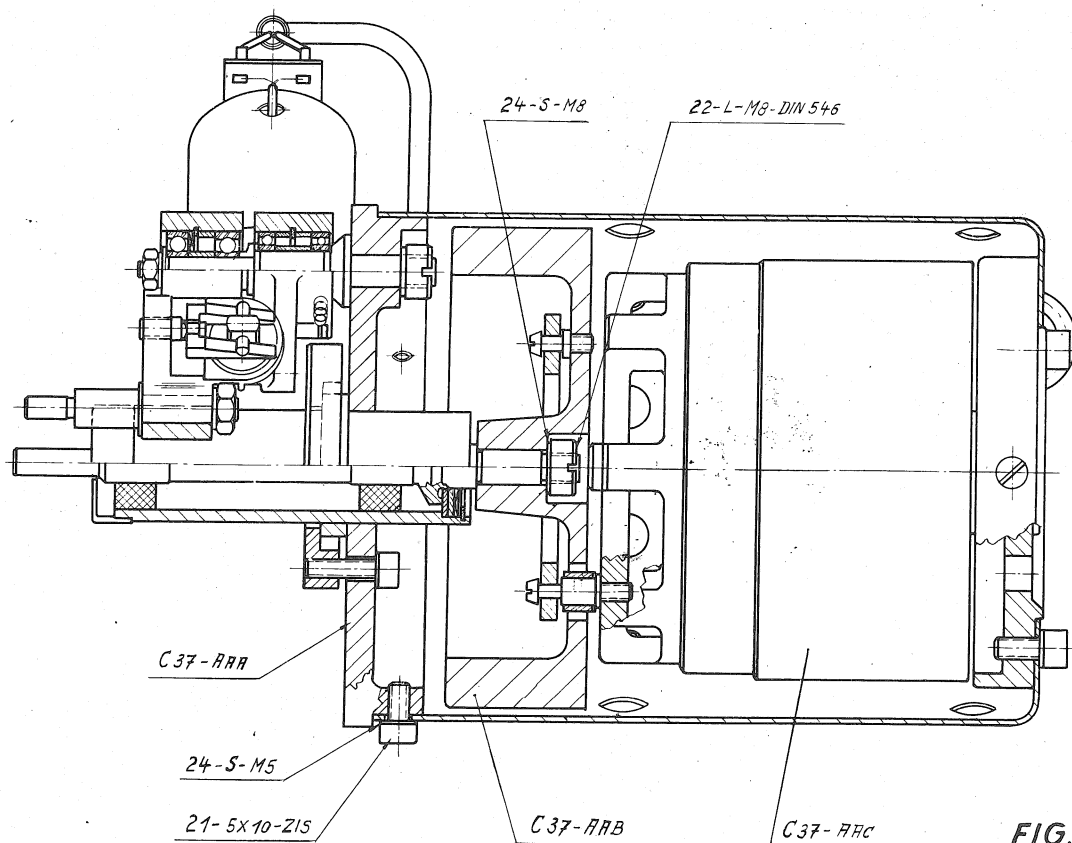

FIG. 9

To exchange the rubber idler, unscrew the conical aluminium cap while holding the idler with one hand. After the cap has been removed the idler can be withdrawn from its shaft. For installation of a new idler, follow the instructions given above in reverse order.

If the capstan assembly is to be replaced, proceed as outlined below:

- a) remove rubber idler (see above),
- b) remove idler bearing,
- c) disconnect motor cables,
- d) remove the three allen-head screws which are holding motor and capstan assembly to the motor plate. During this operation, it is best to have an assistant supporting the bottom end of the drive motor. Withdraw motor and capstan assembly taking great care that no damage will be caused to the delicate surface of the capstan shaft.

Exchange of the capstan shaft is now possible. This is a precision machined part which must be replaced together with its sleeve bearings. It is available from the factory as a carefully inspected replacement part.

- a) Remove the three screws securing the motor casing,
- b) withdraw motor casing and disconnect rubber coupling,
- c) loosen fly-wheel from the capstan shaft and remove idler pressure assembly,
- d) take off the true-arc ring on the capstan bearing and remove bearing.



Re-assemble in reverse order. Using both thumbs push the rubber coupling over the two pins in the motor shaft. Before re-installing motor and capstan, capstan idler pressure has to be adjusted by sliding the magnet cup until the correct pressure of 3 lbs. 5 ozs. (1,5 kg) is obtained with the solenoid fully bottomed. The adjustment screw with the wedge is to be set to approximate centre.

#### 7. THE TAPE CUTTER

The scissors like cutter blades are raised by an eccentric disc which also controls the shearing motion. The cutter does not require any special attention and in the event of mal-function, is best replaced at the whole assembly.

#### 8. THE TAPE TIMER

The travelling tape revolves the guide pulley on the right hand side of the recorder which in turn drives, via a worm-gear and timing belt, the precision timer. Re-setting of the timer is effected by operating the recessed zeroing lever on the right hand side of the top plate. For installations where two or more recorders are placed close together, a zeroing lever which can be operated from above the face of the top plate is available.

#### 9. POWER SUPPLY FOR THE TAPE TRANSPORT MECHANISM

Power for the tape transport mechanism and the tape tension control circuit is supplied by a separate rectifier-unit mounted in the centre of the cross-member carrying the spooling-motors. After disconnecting the plug-in connections, the chassis can easily be pulled for exchange or repair.

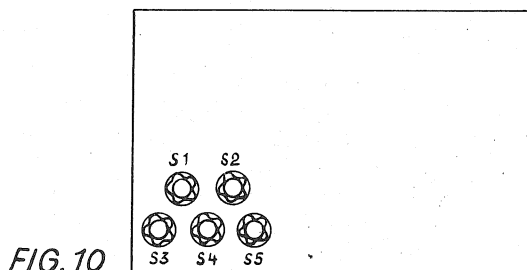

FIG. 10

The following fuses are located in this power supply:

- S 1 1,0 Amp, black, main fuse, transport mechanism,
- S 2 0,4 Amp, black, capstan drive motor,
- S 3 3,0 Amp, blue, relay supply (primary),
- S 4 0,8 Amp, white, tension control rectifier (primary),
- S 5 0,7 Amp, black, spooling motors.

All fuses are of the "slow blow" type.

**Important:** When replacing any burnt fuses, pay special attention to the colour marking on the fuse holder and associated cap. Always put them back in the same order, as the neon indicators in the caps are calibrated to operate on different voltages.

#### 10. THE RELAY BOX

The relay box for the control of all running modes of the recorder is mounted below the power supply. It carries 10 plug-in kamm-relays type Siemens 154 d/93u and 11 power relays with snap-action contacts. Silicon diodes are used on all relays for click suppression. Also on the relay box are all receptacles for connecting the supply lines to the individual subassemblies.

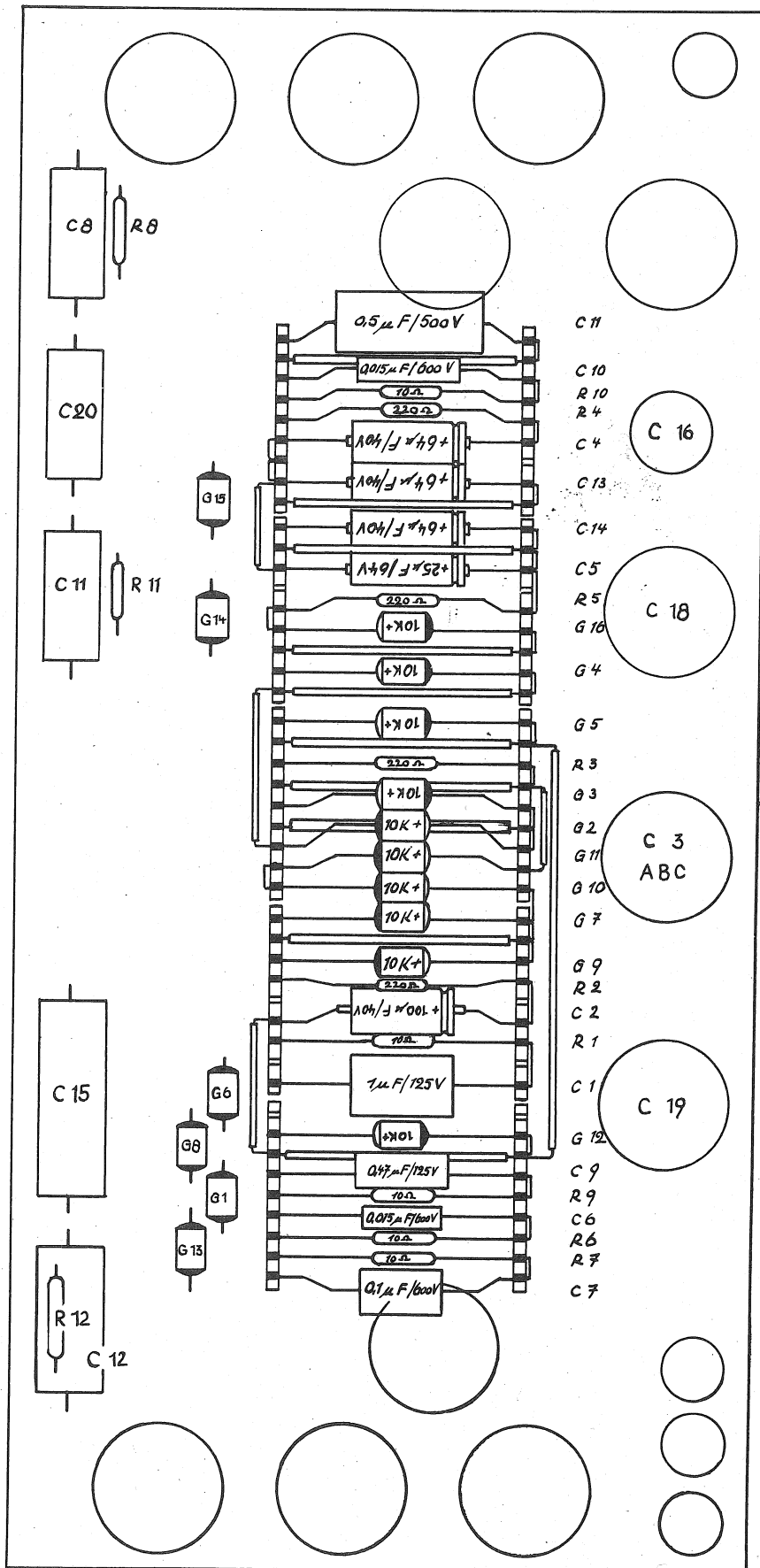

FIG. 11

RELAY - BOARD

## D Amplifiers

All amplifiers and associated power supply are located below the tape transport mechanism.

The electronics of the recorder consist of the following plug-in sub-units:

- Record-amplifier,
- Reproduce-amplifier,
- Bias and erase oscillator with test meter,
- Rectifier for A and B voltages,
- Regulating unit for A and B supply

Each unit can easily be removed after depressing the red locking bar. Oscillator and regulating circuits of the power supply are so dimensioned that the load of additional amplifiers and heads - as required for two track stereo operation - can be carried without effect on the supply voltages. Change-over from one type of operation to another is therefore possible without the necessity of realigning the equipment.

### 1. RECORD AMPLIFIER

The input connector of the record amplifier is on the rear of its chassis and thereby accessible from the rear of the recorder. The signal is fed in a straight forward circuit via the balanced input transformer to the four stage amplifier. Two independent potentiometers serve as level controls for the two tape speeds. A RC-network between the second and third stage acts to provide the necessary pre-emphasis at the high frequencies, the amount of which can be varied with two independent trimmer-capacitors. A plug-in relay switches this equalisation appropriate to the tape speed to be used. From the output stage the audio signal passes a bias-trap and is fed to the oscillator where the bias frequency is being injected.

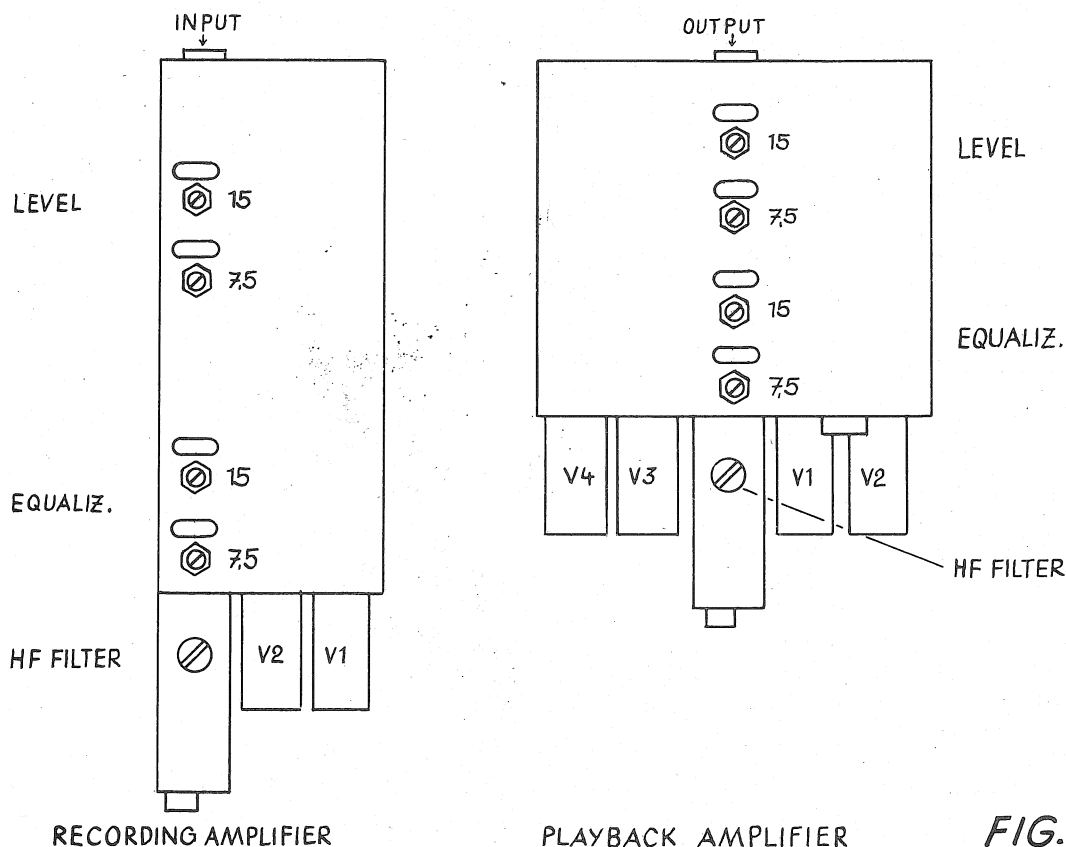

FIG. 12

## 2. OSCILLATOR

The plug-in oscillator is located in the centre of the electronics section. The bias and erase frequency is generated in a push-pull oscillator stage with tuned RF-transformer, the secondary winding of which is feeding the erase head. Bias for the record head (or heads, if two track operated) is adjusted individually for the high and low tape speed. For this, two potentiometers - which are switched into the circuit by a relay - have been provided. Before reaching the record head, the bias signal is amplified in two push-pull stages and fed to the record circuits through tuned RF-transformers. Erase and record heads are plugged into the oscillator-chassis, thus keeping head leads as short as possible.

A meter with selector switch is mounted on the oscillator and permits to check the following voltages and currents:

- 1 = Ua-Oscillator, B-voltage, oscillator
- 2 = Ua-Verstärker, B-voltage, amplifiers
- 3 = U -Relais, Relay voltage
- 4 = U -Heizung, DC A-voltage for input stages
- 5 = I -Bremsstrom, Braking current

With the tension balance set just before actuating the safety switch, the reading must be in the centre of the tolerance mark on the meter scale. With the tension balance locked into its counter-clock-wise position, the reading is to be zero. For both tests the "play" button must be depressed. When depressing the "stop" button or releasing the tension balance to actuate the safety switch the pointer will reach full scale for appr. 2 seconds.

- 6 = I -Löschkopf, erase voltage
- 7 = Vormagnetisierung K 1, bias current, track 1
- 8 = I -Vormagnetisierung K 2, bias current, track 2

In the switch positions 1 - 4 and 6 all readings should be appr. in the centre of the tolerance mark on the meter scale. In the positions 7 and 8 the bias current - depending on the type of recording tape used - will be read, and it is suggested to mark this value for reference in the rectangular fields provided. A detailed treatment of how the optimum bias current is found, follows in section D 3.

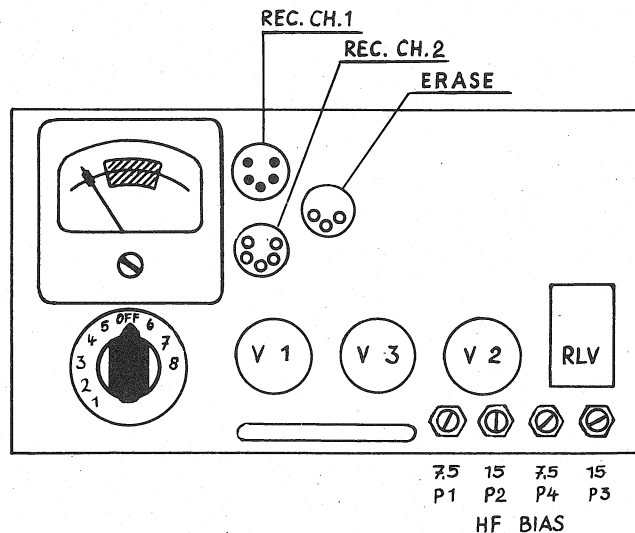

FIG. 13



### 3. REPRODUCE AMPLIFIER

The input connector of the reproduce amplifier is on top of the amplifier chassis next to the socket of the input stage. A very short head cable can thus be used - an important fact to fulfill the requirement of keeping cable capacity low - as the reproduce head is of high impedance type. The amplifier has four stages of voltage amplification with liberal feed back applied. This is followed by a phase inverter and a push pull output stage. The exceptional signal-to-noise ratio of this amplifier has been achieved by the use of a cascode circuit in the first stage. The third stage is working as a cathode follower to obtain the low impedance required by the feed back loop, in which the time constant elements for achieving the reproduce equalisation are contained. A plug-in relay switches this equalisation appropriate to the tape speed to be used. To correct for head wear and gap length dependent frequency losses a second RC-network has been provided between the third and fourth stage.

Two trimmer capacitors allow individual adjustment at the high and low tape speed. Adequate output voltage for all applications is delivered by the push pull output stage at an effectively low internal impedance. The output connector of the reproduce amplifier is on the back of the amplifier chassis and consequently accessible from the rear of the recorder.

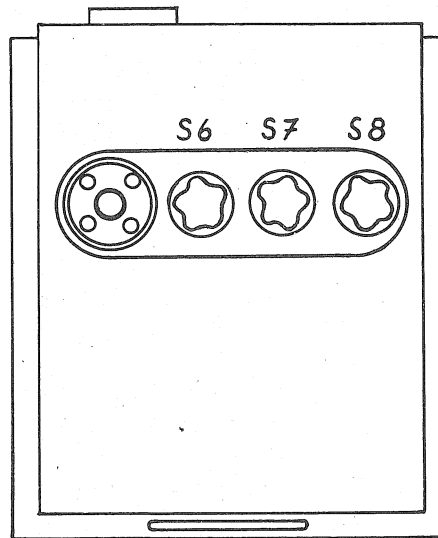

FIG. 14

### 4. RECTIFIER UNIT

Space for the plug-in rectifier unit has been provided to the left of the bias and erase oscillator. It contains the power transformer with special core design to minimise magnetic stray fields, silicon power diodes for rectification of the A and B voltages and selenium rectifiers for the electronic stabilisation. The filter capacitors are of the metallised paper type and assure high operating reliability.

The following fuses are located in the rectifier unit:

- S 6 0.7 amp. , black, power line
- S 7 0.2 amp. , black, B-supply primary
- S 8 2.0 amp. , blue, DC A-supply, primary

Neon indicators contained in the fuse holder caps will glow when a fuse is blown.

Note: When replacing blown fuses, attention must be paid to the colour marking on the fuse holder and associated cap. Always put them back in the same order, as the neon indicators in the caps are calibrated to operate on different voltages.

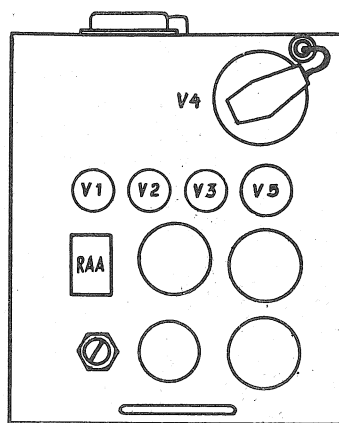

FIG. 15

## 5. REGULATING-UNIT FOR DC-PLATE AND FILAMENT VOLTAGES

Plate supply voltages for all amplifiers and the bias- and erase oscillator, as well as the DC-filament voltages are electronically regulated. Stable voltages independent of power line fluctuations and surges are thus achieved and maintained over long periods of operation.

Only high reliability type professional tubes are used, such as the pentode E 130 L as plate supply regulator and the cascoded double diode E 283 CC in the control stage.

As plate power to the record amplifier and bias- and erase oscillator is required during "record" only, the supply voltage is switched by the relay RAA. RC-networks are used to ensure a smooth rise and decay of the oscillator amplitude as any abrupt pulses would cause clicks and magnetisation of the record head.

The DC-filament voltage for tubes V 1 and V 2 in the reproduce amplifier is regulated by the power transistor OC 27 in conjunction with the Zener-diode Z1 7.

Note: When replacing tubes in the regulating unit, always make certain that all power has been disconnected. Check and be sure that the plate cap has been reconnected to the E 130 L tube, as otherwise the screen grid current would rise excessively high and damage the tube.

After any one of the tubes V 1 to V 5 has been replaced, check B-voltage in the record mode, and if necessary adjust with resistor RW 11 to obtain an indication on the test meter which lies in the centre of the tolerance mark.

## E Alignment and performance Checks

In order to obtain reproducible values in frequency response measurements, the transmission characteristics of a magnetic reproduce amplifier have been laid down by international agreement in the CCIR recommendations 135 of London 1953, and 209 of Warsaw 1956. Calibration tapes specified by the German standard DIN 45513 are made to satisfy these recommendations. To achieve uniform overall response, alignment of the reproduce amplifier has to be completed before adjusting the record equalisation.

## ALIGNMENT TAPES AS PER DIN 45513

Speed	Frequency	Magnetic Level	Azimuth-Adjust Frequency	Level of Azimuth Frequency	Frequency Response	Equalisation
ips.	cycles	milli-Maxwell	cycles	db	cycles	micro sec.
15	1000	200	10 000	-10	30-18000	35
7. 1/2	333	160	8 000	-10	30-15000	100

### 1. REPRODUCE AMPLIFIER ALIGNMENT

- a) Terminate the output into a nominal 600 ohm-load and connect VTVM or other level indicating device across output line.
- b) Select desired tape speed.
- c) Set tape into motion and adjust the output of the first tone (333 or 1000 cps, depending on tape speed) with the potentiometers marked "Pegel 7,5" and "Pegel 15" respectively to the desired transmission level, e. g. +8 dbm. Playback distortion may now be checked. The total harmonic distortion must be less than 2% (predominantly 3rd harmonic).
- d) Adjust azimuth of the reproduce head by slowly rotating the nut C, Fig. 7 (playback) until a maximum reading is obtained on the level indicator, as the appropriate frequency for this adjustment is reproduced.

Note: The level of the azimuth adjust frequency is recorded 10 db below the maximum tape level and will already provide a good indication of the frequency response of the equipment.

- e) Take readings of the frequency bands which follow and if necessary adjust trimmer capacitors 7,5 and 15 respectively to obtain output levels at 10.000 cps which are within the specified frequency response tolerance.

Important: Do not attempt to correct for inefficient high frequency output before it has been ascertained that the reproduce head azimuth is accurately aligned.

- f) Stop the tape motion and read the reproduce amplifier noise. The signal-to-noise ratio obtained should be equal to or better than that specified in the technical data.

### 2. RECORD AMPLIFIER BIAS ADJUSTMENT

Note: Optimum bias will depend on the brand of tape which is used on the equipment and best overall performance will only be obtained if alignment is carried out as outlined below:

BEFORE MAKING ANY ADJUSTMENTS ON THE RECORD AMPLIFIER, BE SURE THAT THE REPRODUCE SECTION HAS BEEN CHECKED AND IS PERFORMING SATISFACTORY.

- a) Connect measuring equipment to the output of the recorder as described under E 1a.
- b) Connect audio oscillator to the recorder input and set to a frequency of 1000 cps for 15 ips tape speed or 333 cps for 7,5 ips.
- c) Set tape into motion and adjust record level (oscillator level) for an output reading which is appr. 10 db below the standard transmission level. Too high a level will cause tape saturation and produce erroneous results.

- d) Turn the bias control 7, 5 or 15 depending on tape speed fully counter-clock-wise for minimum bias current, then slowly increase again until maximum audio level is read on the output of the recorder. Leave the bias control at this setting when adjustment is carried out at a tape speed of 7, 5 ips. At 15 ips bias current has to be increased slightly until the audio signal on the recorder output has dropped by appr. 1.5 db.

DO NOT CHANGE THESE SETTINGS AS OTHERWISE PERFORMANCE AT THE HIGH FREQUENCIES WOULD BE AFFECTED.

### 3. RECORD LEVEL CALIBRATION AND DISTORTION MEASUREMENT

- a) With the oscillator set to standard transmission level, the record level can now be adjusted with the potentiometers "pegel 7, 5" and "pegel 15" in the record amplifier, at the frequencies of 333 cps and 1000 cps at the tape speeds of 7, 5 ips and 15 ips respectively. Adjust the controls until an output reading as described under E 1c is obtained.
- b) Overall harmonic distortion at the so adjusted level may now be measured. To prevent any bias signal from interfering with this test, distortion readings should only be taken when reproducing a previously recorded signal of peak level. Correct performance is indicated when the total harmonic distortion is less than 2%.

### 4. RECORD AZIMUTH ADJUSTMENT

- a) Set oscillator to 8.000 cps or 10.000 cps depending on tape speed used and adjust its level to be at least 10 db below peak level.
- b) While recording this frequency adjust nut C, Fig. 7, on the record head and find setting which yields maximum level on the output indicator. If several peaks appear, slowly rotate the adjustment nut until a pronounced maximum is indicated.

### 5. OVERALL FREQUENCY RESPONSE

WHEN MAKING OVERALL FREQUENCY RESPONSE TESTS, IT IS EXTREMELY IMPORTANT TO RECORD AT LEVELS 20 DB BELOW PEAK SIGNAL IN ORDER TO AVOID TAPE SATURATION AT THE HIGH FREQUENCIES.

- a) Record 333 cps or 1.000 cps depending on tape speed, at a level of -20 db.
- b) Record 10.000 cps at the same input level of -20 db and adjust the trimmer capacitors 7, 5 and 15 respectively to obtain output levels which are within the specified tolerance limits at this frequency.
- c) Make a response check by recording frequencies from 30 - 15.000 cps.

### 6. NOISE MEASUREMENT

Before taking noise level readings as well as to maintain the recorder at optimum performance with respect to noise, the following important points should be carefully observed.

- a) Demagnetise all heads in a gradually diminishing AC field at regular intervals.
- b) The bias trap in the playback amplifier should be tuned for minimum RF as measured at the output of the playback amplifier. If due to sensitivity limitations of the VTVM the minimum indication is inaccurate, a wide band oscilloscope should then be used for this test. Retuning will be necessary after a change in the bias current adjustment has been made.
- c) Select tube V 1 (first stage of playback amplifier) for best noise reading. Variations in the order 2 to 3 db can sometimes be observed from tube to tube.
- d) It is suggested that, whenever possible, noise readings should only be taken with a VTVM or noise meter whose response does not extend beyond 15.000 cps.

Record noise measurements may be taken in one of the following forms:

- a) Tape in motion and in contact with the heads while the record circuits are switched on. In this test the input of the recorder is to be short circuited. As the noise reading may be effected by some bias leaking into the playback amplifier, a meter having only negligible response at 80,000 cps should be used.
- b) Measure the nuisance value of the electrical noise by taking a weighted reading (weighting network response to be in accordance with ASA A or DIN 3).

The signal-to-noise ratio obtained will depend on the brand of tape used, but it must at least be equal to that specified in the technical data.

#### 7. ERASE EFFICIENCY

To measure erase efficiency the recorder is operated at 15 ips. Read residual signal at playback amplifier output while erasing a previously recorded 1,000 cps tone. Short circuit the record amplifier input during this measurement. This test is best being made through a 1,000 cps narrow band pass filter or with a wave analyser. If an objectionable amount of residual 1,000 cycles is indicated, adjust azimuth of erase head for maximum efficiency.

#### 8. WOW AND FLUTTER

For this test it is suggested to use the EMT 414 wow- and flutter-meter for a test frequency of 5,000 cycles, or the EMT 418 wow- and flutter-analyser for a test frequency of 3,000 cps. If one of these instruments is used, the reading should be taken through the weighting network (refer to CCIR report No. 78 Warshaw 1956) comparable readings will be obtained with either instrument. However, they will be dissimilar from values obtained with RMS reading meters as both the EMT 414 and the EMT 418 are peak to peak reading devices. If a permanent record of the test results is desired, the use of the high speed graphic recorder "HELCOSCRIPTOR He-1b" is recommended.

#### 9. MISCELLANEOUS MEASUREMENTS

It may be advisable to check from time to time the performance of the bias trap in the record amplifier. For this test a VTVM is to be connected between chassis and the junction of R 19 and C 9 in the record amplifier. With the bias and erase oscillator switched on (record mode) tune this LC combination for minimum indication on the VTVM.

Accurate readings of bias and erase currents may be taken at the pins 6 and 7 and 2 and 3 respectively of the tuchel connectors in the head block, which are accessible after removing the cover plate as described under C 1.

## F *Maintenance Schedule*

Assuming a daily operation of the recorder of 8 - 10 hours, it is suggested to carry out the following routine maintenance work at the time intervals indicated:

Daily:                      clean heads                      using a soft lint free cloth, clean head face and remove any hardened deposits with carbon tetrachloride.  
If high quality tapes are used, leaving only a negligible deposit, this work may be reduced to a weekly operation.

<u>Weekly:</u>	demagnetise heads and all steel parts in the tape path	using a head demagnetiser or other suitable demagnetising coil, subject all steel parts to an AC field. Remove coil gradually before disconnecting from power line.
	check operating voltages and currents	Turn selector switch on the oscillator chassis from step one through eight and observe whether pointer still indicates within the tolerance mark. Check if bias readings in position 7 and 8 still correspond to the readings found as described under E 2d.
<u>Monthly:</u>	clean capstan idler	If a brown deposit starts to accumulate on the rubber idler, the idler is to be taken off its shaft (see section C 6) and to be cleaned in carbon tetrachloride. Do not use carbon tetrachloride while the capstan idler is installed on the machine, as this will bring on the danger of washing the grease out of the capstan bearing and also may cause damage to the painted surfaces.
	clean capstan shaft	If during the first weeks of operations excess grease is leaking from the capstan bearing onto the shaft, clean away with a soft lint free cloth. Never use any solvent on the capstan shaft. Hardened deposits are best removed with either a pencil eraser or an orange-stick.
	lubricate tape timer	Lubricate bearings of all fast running parts e.g. worm and seconds-digits with a high quality oil (sewing machine oil). Do not over lubricate.
	Alignment and performance checks	Check levels and bias as per sections E 1a to c, E 2a to d and E 3a to b.
		Check head azimuth as per section E 1d and E 4a to b.
		Take frequency response readings as per section E 1e and E 5a to c.
		Measure signal-to-noise ratio as per E 1f and E 6a to f.
<u>Quarterly:</u>	adjust brake tension	Check brakes for proper tension as per section C 2.
	capstan idler pressure	Check as per section C 6.
	spooling motors	After 1.000 operating hours or three months whichever occurs first, remove screws from the red circled oil holes and place 5 to 10 drops "Teresso 43" in each hole.
<u>After 10.000 operating hours or 4 years, whichever occurs first</u>	install new head assembly	Depending on the smoothness of the emulsion of the tape used, the heads will in time become worn to the point where serious high frequency losses start to occur. As replacing an individual head is a rather delicate operation and requires a highly qualified technician, it is best to replace the whole head assembly. This is done as described in section C 1.

Whenever a head assembly gets replaced or exchanged, the bias-traps in the record and reproduce amplifiers should be realigned (see sections E 6b and E 9).

replace capstan bearing

The Capstan bearing has a large grease supply (under the plastic cap) which should last for the life of the bearing. Once this grease supply has used itself up, it is best to replace bearing and capstan shaft. For removal of the capstan, refer to section C 6.

lubricate the capstan motor

According to the manufacturer's recommendations, lubrication of the capstan motor is required only when it starts to develop running noises. However lubrication may be advisable after this operating period and can easily be carried out after the motor has been removed from the motor deck. Unscrew the bearing-disc and place 5 to 10 drops of "Teresso 43" onto the shaft bearing.

**Important:** All other moving parts of the recorder, especially all ball bearings in the guide rollers and pulleys are lubricated for life and must not be oiled. Their normal life expectancy is appr. 20.000 hours. Should running noises develop before this period of time has elapsed, it is best to replace the faulty bearing with the factory approved low noise type, the stock number for which can be found in the parts lists.



## *Parts List*

*of Components and Subassemblies which are Subject to Wear*

<u>PART-DESCRIPTION:</u>	<u>STOCK-NUMBER:</u>
Turntable, complete,	C 37-Q
Adapter for DIN cores	B 30 - C
Adapter for EIA reels	B 30 - D
Erase- head	16 - A
Record-head, full track	16 - B
Playback-head, full track	16 - C
Record-head, two track	16 - D
Playback-head, two track	16 - E
Head assembly, full track	20 - A
Head assembly, pilot tone	20 - B
Head assembly, two track	20 - C
Relay 65421-94n (Siemens)	56-LTrls 154d
Power connector, chassis receptacle	Feller 8343 JE
Cord plug	Feller 8343
Audio connector, input	
Cannon receptacle with socket insert	XLR-3-32
Cannon plug with pin insert	XLR-3-11C
Audio connector, output	
Cannon receptacle with pin insert	XLR-3-31
Cannon plug	XLR-3-12C
Remote control connector	
Amphenol plug with pin insert	86-CP-11
Capstan assembly	C 37-AA
Capstan bearing, complete specify 50 or 60 cycles	C 37-AAA. A
Capstan solenoid	14-B
Capstan motor, incl. cable	C 37-AAC. A
Capstan idler bearing	C 37-AB
Ball bearing (Müller)	41-L-EL6-Z-ehG
Capstan idler	C 37-AC
Idler bearing	C 37-AB
Ball bearing (Müller) for first idler	41-L-EL8-Z
Tension control assembly	C 37-AE
Potentiometer assembly	C 37-AED
Switchlever complete	C 37-AEE
Solenoid complete	C 37-AEF
Tension control, idler assembly	C 37-AF
Ball bearing RMB	41-L-511
Dash pot, tension control	C 37-AD

Flywheel and flywheel idler assembly, complete	C 37-AG
Ball bearing (Müller)	41-L-EL8-Z
Solenoid	C 37-AGA.A
Tape cutter assembly, complete	C 37-AH
Synchronous motor, incl. gears	C 37-AHA-1
Cutter blades	C 37-AHB-2a+3
Tape timer	C 37-AI
Ball bearing (Müller)	41-L-EL4 ZZ
Ball bearing (Müller)	41-L-LL5 ZZ
Timing belt (Power grip)	60xL 025
Push button assembly, left hand side	C 37-AK
Push button "fast forward"	C 37-AKA
Push button "fast reverse"	C 37-AKB
Push button playback	C 37-AKC
Push button stop	C 37-AKD
Push button erase	C 37-AKE
Pilot light socket, special	C 37-AK-8
Pilot lamp F9-24V/0,08A (Rafi)	51-L-2821
Push button "cutter"	C 37-ALA
Push button 7,5	C 37-ALB
Push button 15	C 37-ALC
Push button off	C 37-ALD
Snap action switch 1A/250V (Marquart)	55-L-1010
Brake band, special	C 37-AMA.C
Brake drum, complete	C 37-AMA.D
Torque motor, supply-rewind	C 37-AMA.K
Torque motor, take-up	C 37-AMA.L
Brake solenoid	14-C
Relay box	C 37-AMB
Solenoid 1500 ohms (Erni)	56-L-MA 20 (u)
Solenoid 630 ohms (Erni)	56-L-MB 20 (u+u)
Horometer 3	73-L
Light bulb, bayonet base (Osram)	51-L-60W
Power supply for tape transport	C 37-AMC
Power transformer, tape transport	C 37-AMC.C
Diode, silicon (Tarzian)	4x10L
Diode, silicon (Tarzian)	4x10K
Transistor (Philips)	ASZ 15
Tape lift mechanism	C 37-AN
Pin, tape lift	C 37-AND
Dash-pot for tape lift mechanism	C 37-ANF

Solenoid	14-C
Idler roller, small	C 37-AP
Amplifier, record	C 37-C
Transformer, record input	B 30-BL
Choke, record amplifier	C 37-CDA
Amplifier, playback	C 37-D
Transformer, playback output	B 30-BH
Metal-film resistor (Metall-Lux)	57-330 kohms-1-2%
Power supply for amplifiers	C 37-E
Power transformer, amplifier supply	C 37-EBA
Mounting board, resistors	C 37-EBA.B
Diode, silicon (Tarzian)	4x10J
Diode, silicon (Philips)	4xDA 214
Rectifier, germanium (Siemens Flachgleichrichter)	B 250 C 75
Oscillator, bias and erase, complete	C 37-F
Coil, oscillator	C 37-FBB
RF choke	C 37-FBC
Symmetry transformer	C 37-FF
Regulator section for power supply, complete	C 37-G
Transistor (Philips)	OC 27
Zenerdiode (Intermetall)	ZL 7
Plug, tape tension normal	C 37-I
Plug, tape tension special	C 37-K

## A P P E N D I X

### With Reference to A - Technical Data

Cross talk when two track stereo operated better than 50 db at 1000 cps.

### With Reference to B 1 - Installation

Consoles for installation of the recorder are available upon request and must be ordered separately. Two versions can be supplied:

1. An all-steel construction of sheet metal with built-in VU-meter and range multiplier, finished with hammerlin-grey enamel, suitable for use in tropical climates.
2. A wooden console covered with arborite of approximately the same dimensions and design as the above described and as pictured on the front cover of this manual.

### With Reference to B 4 - Remote Control

Two forms of remote controlled operation are possible.

If all functions of the recorder are to be controlled from a remote point, then a set of five push buttons together with their associated pilot lights is to be connected via a 9-conductor-cable to the remote receptacle as shown in Fig. 1. The remote control box can then be arranged so as to be conveniently within reach of the mixer at the audio console.

For controlling the playback-mode only, as may be desirable in radio work, the recorder can be started and stopped with the operation of a cueing contact on the audio fader. The design of this contact must be such that it opens when the fader is in its closed or infinite attenuation position. An external 24V DC supply connected via the fader contact to pins 10 and 11 of the remote receptacle (Fig. 1) will energize the start-stop relay in the recorder. If the internal 24V supply is to be utilized, a strap has to be put from pin 2 to 11 and the fader contact must be connected between the pins 9 and 10.

In installations where the recorder controlled in the described manner, is located in rooms separate from the audio control room, signalling lights indicating the readiness of the machine may be advisable.

### With Reference to B 16 - The Timer

For exact timing of programs or program sections it may be desirable to have the tape timer start exactly at the point where the program commences. To avoid erroneous indication due to excessively long leaders etc., the reset lever of the tape timer may be held downwards, thus keeping the timer zeroed until it is released at the desired moment.

With Reference to B 17 - Tape Cutter

When editing and cutting pre-recorded programs it may often be necessary to insert sections of tape which have been cut by other means than the built-in scissors of the STUDER C 37, and the cutting angle may not agree or correspond to the one to which it is to be spliced, which could give rise to clicks at the splices. In such cases simply hold the tape by hand in front of the cutter opening and depress the appropriate buttons as described in section B 17 and a clean cut of the correct angle will be obtained.

With Reference to C - Tape Transport

It is felt that the instructions given under the above heading are not descriptive to the extent which will assure that the operation when raising the motor deck, will be performed as intended by the designer. A step-by-step instruction is therefore given below:

1. Firmly rest the palms of your hands on the front left- and right hand corners of the motor-deck.
2. Using considerable force, press downwards while simultaneously depressing the recessed buttons on each side of the deck-plate with your index-fingers.
3. After the snap-locks have been released by depressing the buttons, the motor-deck will be pushed upwards by strong springs and care must be taken to absorb this shock and to avoid a sudden fling.
4. When returning the motor-deck into its normal operating position press firmly downwards with both hands, making certain that both latches lock securely.

With Reference to C 4 - Flywheel

With the motor-deck raised, all running modes of the recorder will function normally and any tests - with the exception of flutter and wow readings - may be carried out. Some motion irregularities may occur in this raised position, as the flywheel is designed to ride on the tapered shaft which is driven by the moving tape. Once this shaft has been displaced from the vertical axis by more than 30° proper engagement of the taper is not assured any more, thus adversely affecting the motion characteristics of the recorder.

It must be emphasized that it should not be regarded as a fault of the machine when such observation is made.

With Reference to E 3 and E 6 - Record Level, Distortion,  
Signal-to-Noise Ratio

Tape manufacturers supply magnetic recording tapes for a great variety of applications. Amongst others there are some with so-called hard- or high output emulsions, such as Scotch 120 HO or Agfa FR 22. These tapes can be utilized to realize one of two possible alternatives:

... / ...

1. Highest quality recordings with respect to harmonic distortion, accepting the normal signal-to-noise ratio as obtained when modulating to a specified tape flux, e.g. 200 milli Maxwell.
2. Increased signal-to-noise ratio by as much as 6 db by recording to a specified level of harmonic distortion, such as the commonly accepted 3%.

The increased audio levels required or obtained when working to the latter method can safely be handled by the amplifiers of the STUDER C 37 recorder, as they are designed to have ample overload reserve. However, some tapes, when recorded to extremely high levels, will in time and depending on storage conditions produce a print-through-effect. An Echo-Raser which considerably reduces this undesirable phenomena during playback of any such tapes, is available as an accessory.

It would be appreciated if any comment you may have regarding the instructions given in this manual could be forwarded to

EMT Wilhelm Franz GmbH., WETTINGEN, Switzerland

so as to enable us to include or change whatever may be necessary in future issues to the benefit of all users of this recorder.



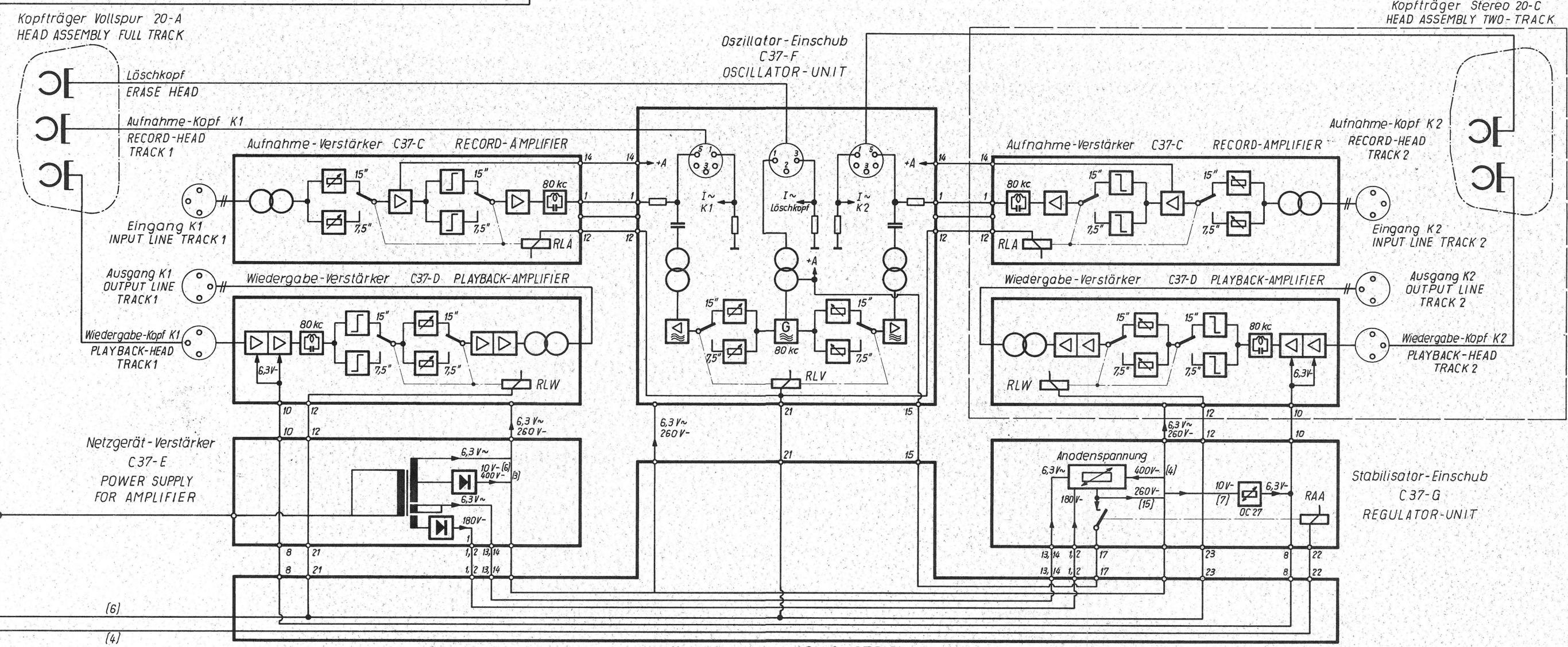
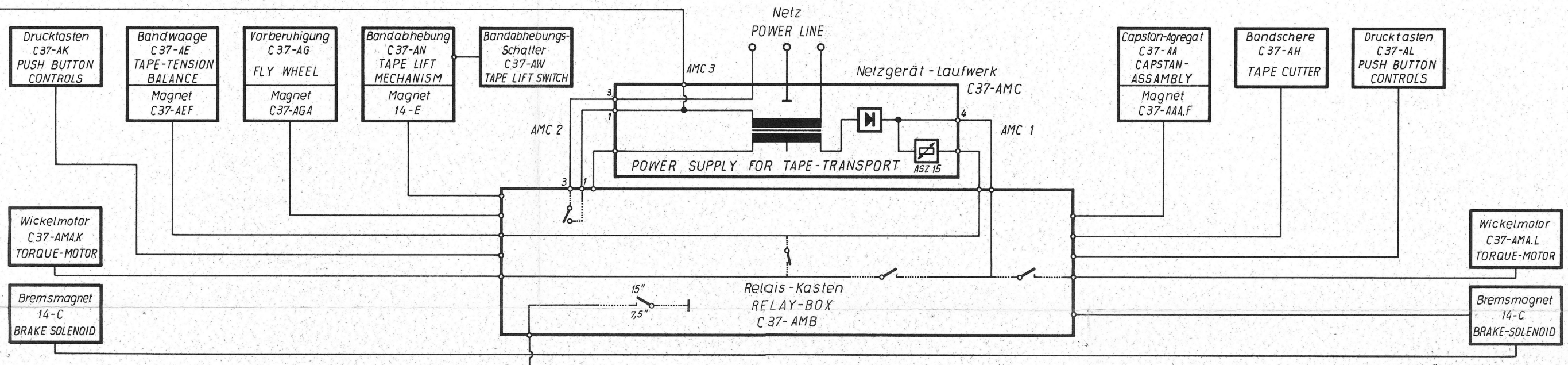

Kabelkanal PLUG-STRIP C37-BD

RLA Relais Aufnahme	7.5"-15"	RECORD
RLW Relais Wiedergabe	7.5"-15"	PLAYBACK
RLV Relais Vormagnetisierung	7.5"-15"	BIAS-CURRENT
RAA Relais Anodenspannung Aufnahme	B-VOLT.	RECORD

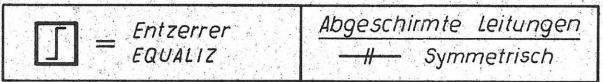



<p>REGENSDORF ZÜRICH</p>	<p><b>STUDIO-MAGNETTON-GERÄT BLOCKSCHEMA</b></p>		<p>Maßstab</p>	<p>Bez. 20.4.61</p>	<p>Wm</p>
	<p>Ersatz für</p> <p>Ersetzt durch</p>		<p>Gepr. 24.4.61</p>	<p>Aend.:</p> <p><b>C37</b></p>	



# Tabelle der Relais, Schützen und Magnetfunktionen C-37

**VORBEDINGUNGEN:** Band eingelegt; Bandwaage in Arbeitsstellung.  
(Endschalter: Relais RE zieht an und betätigt Funktion STOP)

**ZEICHENERKLÄRUNG:** X : Relais (Schütz, Magnet) angezogen  
0 : Relais (Schütz, Magnet) abgefallen

   sind im Zusammenwirken mit den übrigen Funktionen zu verstehen.



LEINSDORF  
ZÜRICH

RELAIS	←		→		♪	STOP	♪	REGLER START		7,5"	15"	Eingebaut in:	
	←	←	→	→									
RE	0	0	0	0	0	0	0	0				C 37 - AMB Relaiskasten	
RF	0	0	0	0	0	0	0	X					
RFv	0	0	0	0	0	0	0	X					
RR	0	X	0	0	0	0	0	0					
RV	0	0	0	X	0	0	0	0					
RB	0	0	0	0	X	0	X	X					
RA	0	0	0	0	0	0	X	0					
RAM	X	X	X	X	0	X	0	0					
RL									X	0			
RSCH									0	X			
RAA	0	0	0	0	0	0	X	0					C 37 - G Stabilisator - Einschub
RLV									X	0			C 37 - F Oszillator - Einschub
RLA									X	0			C 37 - C Aufnahmeverstärker
RLW									X	0			C 37 - D Wiedergabeverstärker
<b>SCHÜTZEN</b>													
SSM									X	X		C 37 - AMB Relaiskasten	
SRb	0	X	0	0	0	0	0	0					
SRa	X	0	0	0	0	0	0	0					
SVa	0	0	X	0	0	0	0	0					
SVb	0	0	0	X	X	0	X	X					
SBrv	0	X	0	X	X	0	X	X					
SSTv	X	X	X	X	0	X	0	0					
SL									X	0			
SL									X	0			
SSCH									0	X			
SSCH									0	X			
<b>MAGNETE</b>													
M - AA	0	0	0	0	X	0	X	X				C 37 - AA Capstan - Aggregat	
M - AE	0	X	0	X	X	0	X	X				C 37 - AE Bandausgl. - Aggregat	
M - AG	X	X	X	X	0	X	0	0				C 37 - AG	
M - AMA	X	X	X	X	X	0	X	X				C 37 - AMA Motorträger - Chassis	
M - ANI	0	X	0	X	0	0	0	0				C 37 - AN (Bremsen)	
M - AN2									X			C 37 - AN Bandabhebungs-Aggregat	

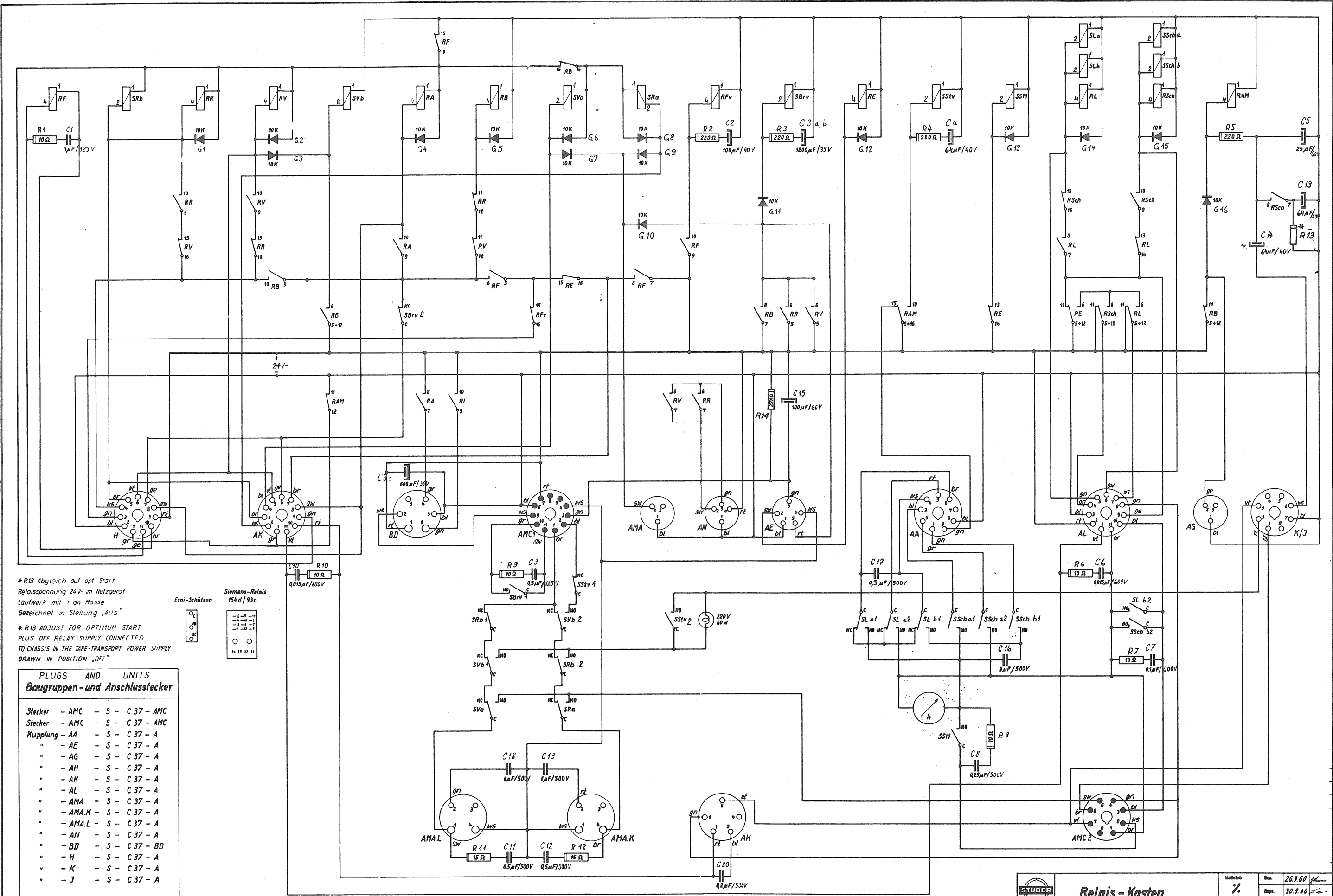

\*R13 Abgleich auf opt Start  
 Relaisspannung 24V im Netzgerät  
 Laufwerk mit + an Masse  
 Gezeichnet in Stellung „Aus“

\*R13 ADJUST FOR OPTIMUM START  
 PLUS OFF RELAY-SUPPLY CONNECTED  
 TO CHASSIS IN THE TAPE-TRANSPORT POWER SUPPLY  
 DRAWN IN POSITION „OFF“

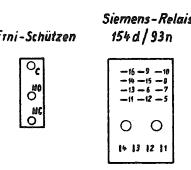

**PLUGS AND UNITS**  
**Baugruppen- und Anschlussstecker**

Stecker	- AMC	- S	- C 37 - AMC
Stecker	- AMC	- S	- C 37 - AMC
Kupplung	- AA	- S	- C 37 - A
"	- AE	- S	- C 37 - A
"	- AG	- S	- C 37 - A
"	- AH	- S	- C 37 - A
"	- AK	- S	- C 37 - A
"	- AL	- S	- C 37 - A
"	- AMA	- S	- C 37 - A
"	- AMA.K	- S	- C 37 - A
"	- AMA.L	- S	- C 37 - A
"	- AN	- S	- C 37 - A
"	- BD	- S	- C 37 - BD
"	- H	- S	- C 37 - A
"	- K	- S	- C 37 - A
"	- J	- S	- C 37 - A

□ = 1W

	<b>Relais - Kasten</b>		Method %	Bez. 26.9.60 Rep. 30.9.60
	Erteilt für Erteilt durch		Anm.: a) 23.2.-4.1.2001 <b>S - C 37 - AMB</b>	

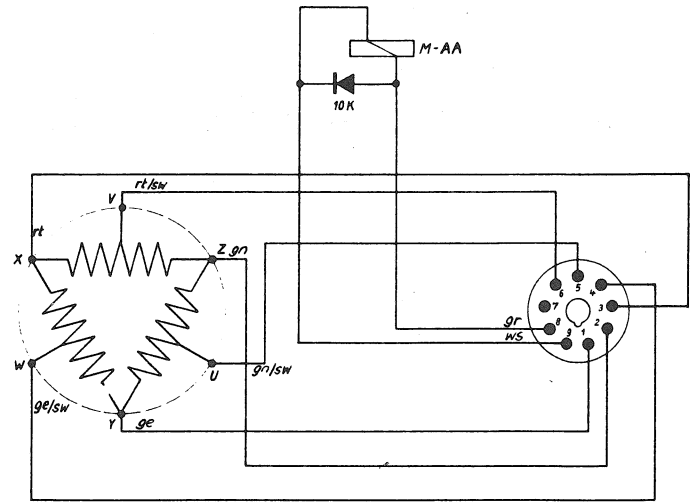

C37-AA

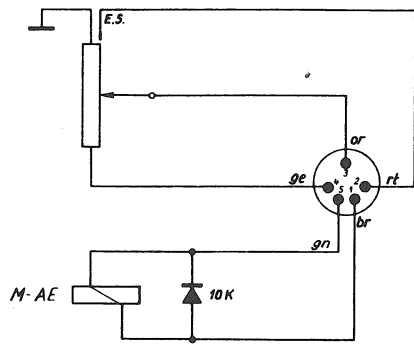

C37-AE

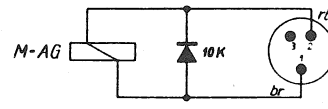

C37-AG

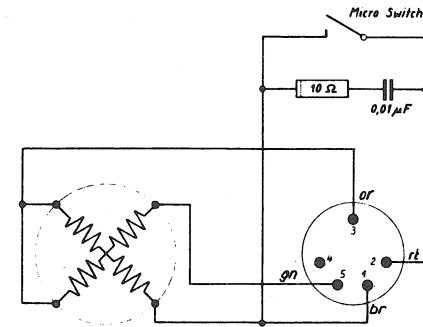

C37-AH

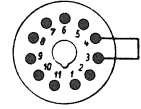

C37-H

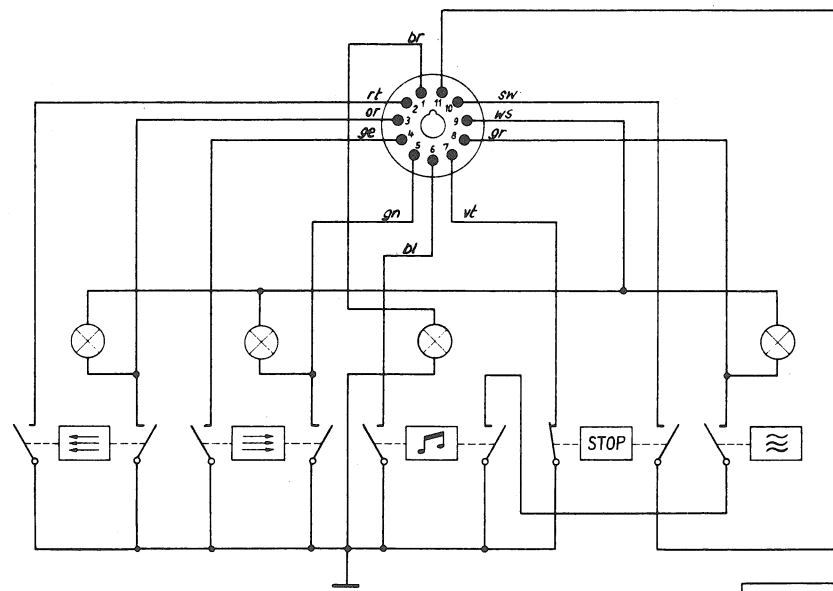

C37-AK

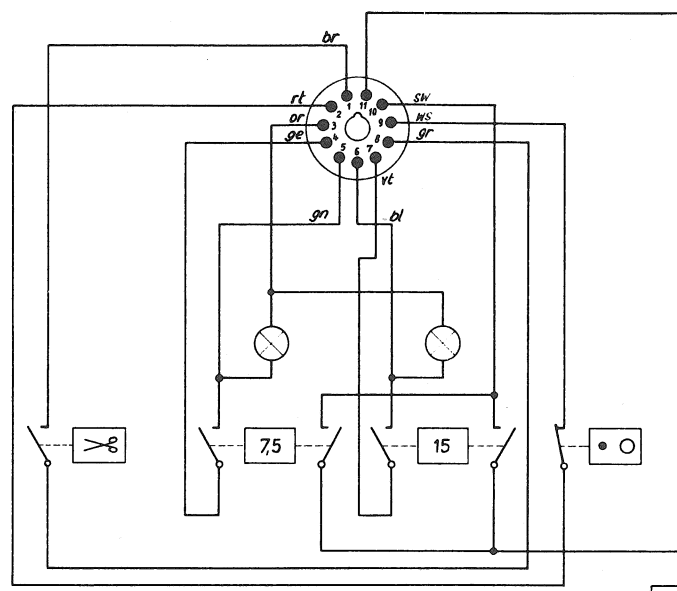

C37-AL

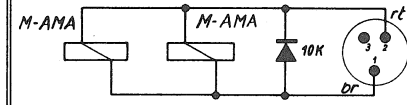

C37-AMA

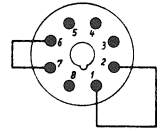

C37-K

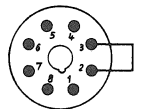

C37-J

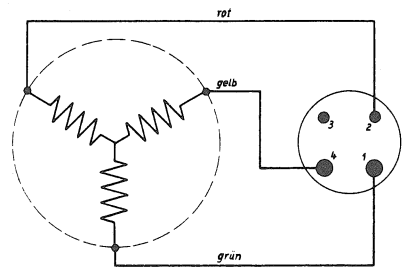

C37-AMA.K

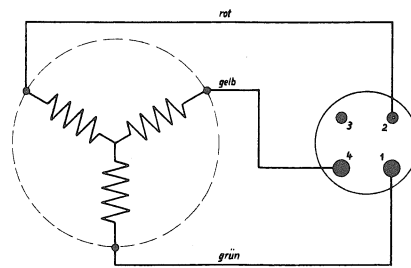

C37-AMA.L

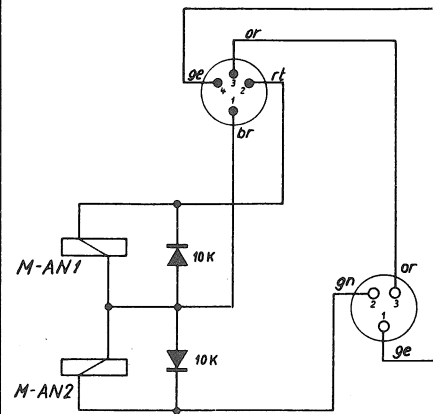

C37-AN

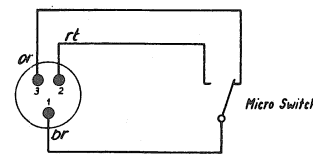

C37-AW

⊗ = Glühlampe F9, No. 2821-24V/0,08A (Rafi)  
 PILOT LAMP F9, NO. 2821-24V/0,08A (Rafi)

Stück	Pos.	No.	Gegenstand	Mat.	Bemerkung
			Laufwerk montiert		
				Maßstab	Gr. 28.9.60
					Gr. 30.9.60
				Ann. 11.4.61	
REGENSDORF ZÜRICH				Ersetzt durch	S-C37-A

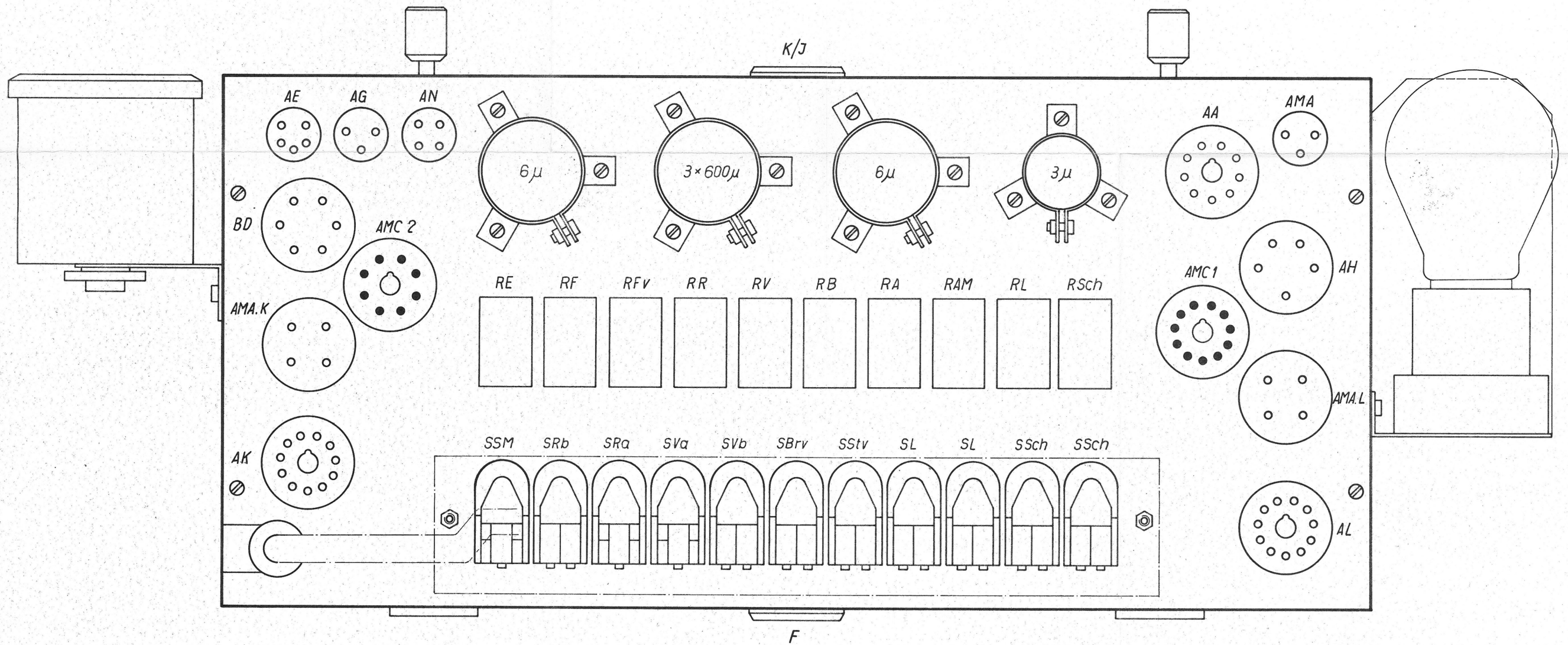

Stück	Pos.	No.	Gegenstand	Mat.	Bemerkung
 REGENSDORF ZÜRICH	<h2 style="text-align: center;">Relais-Kasten</h2>			Maßstab Gez. <b>21.4.61</b> <i>wue</i> Gepr. <b>24.4.61</b> <i>---</i>	Aend.: <h3 style="text-align: center;">B-C37-AMB</h3>
				Ersatz für Ersetzt durch	

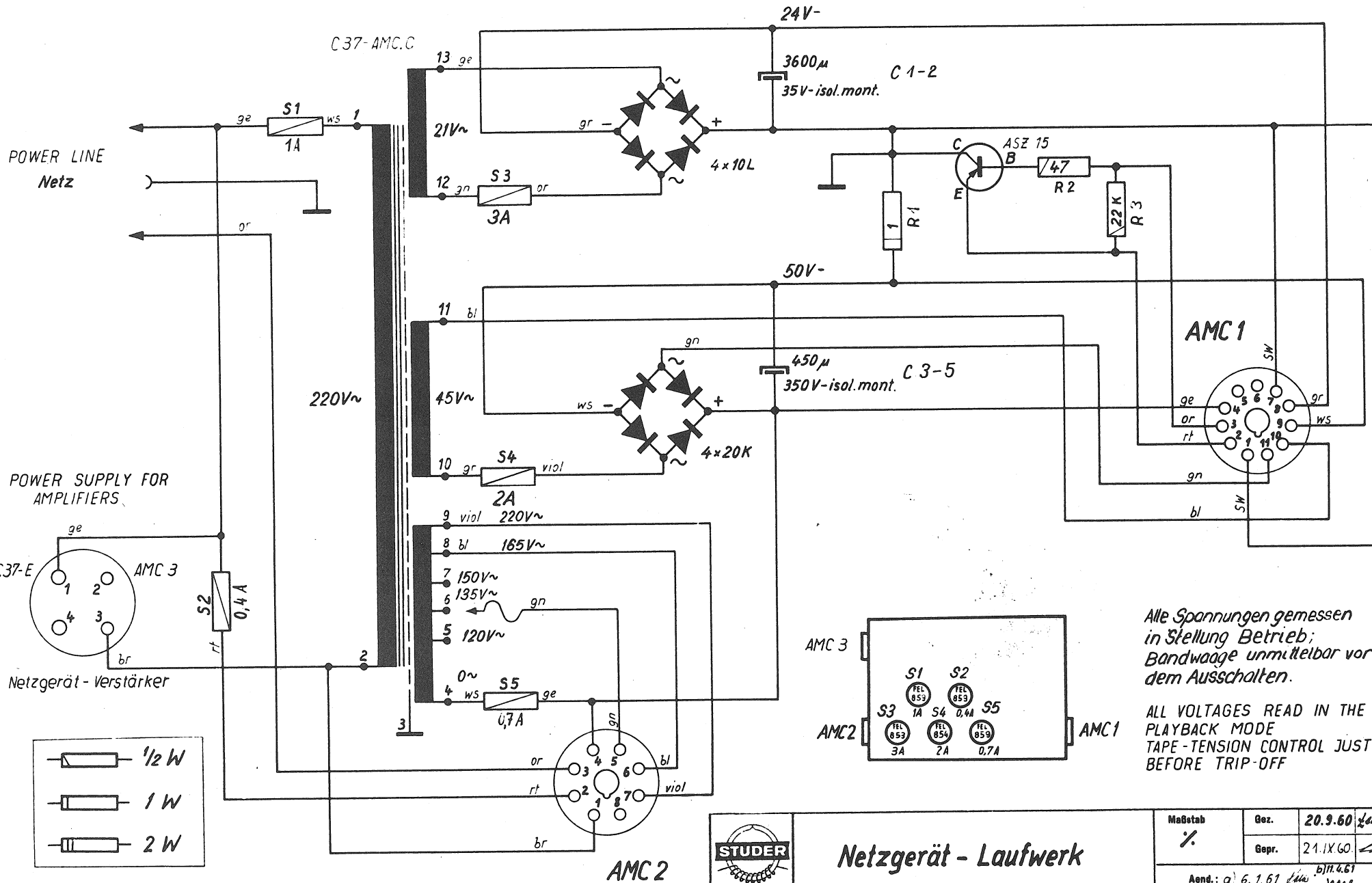

Alle Spannungen gemessen  
in Stellung Betrieb;  
Bandwaage unmittelbar vor  
dem Ausschalten.

ALL VOLTAGES READ IN THE  
PLAYBACK MODE  
TAPE-TENSION CONTROL JUST  
BEFORE TRIP-OFF



## Netzgerät - Laufwerk

Ersatz für  
Ersetzt durch

Maßstab %	Gez.	20.9.60	<i>[Signature]</i>
	Gepr.	21.IX.60	<i>[Signature]</i>
Aend.: a 6.1.61 <i>[Signature]</i> <i>[Signature]</i>			

# S-C37-AMC

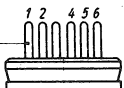
- |           |            |   |   |
|-----------|------------|---|---|
| 1 = braun | 1 = BROWN  | PLUGNUMBER IDENTICAL<br>TO COLOURNUMBER<br>Steckernummer = Farbnummer |  |
| 2 = rot   | 2 = RED    |   |   |
| 4 = gelb  | 4 = YELLOW |   |   |
| 5 = grün  | 5 = GREEN  |   |   |
| 6 = blau  | 6 = BLUE   |   |   |
|           |            |   |   |

53-L-86-CP6

Isolierschlauch

SOLDER TERMINALS VIEWED FROM THE REAR  
 Von hinten auf die Lötanschlüsse gesehen.

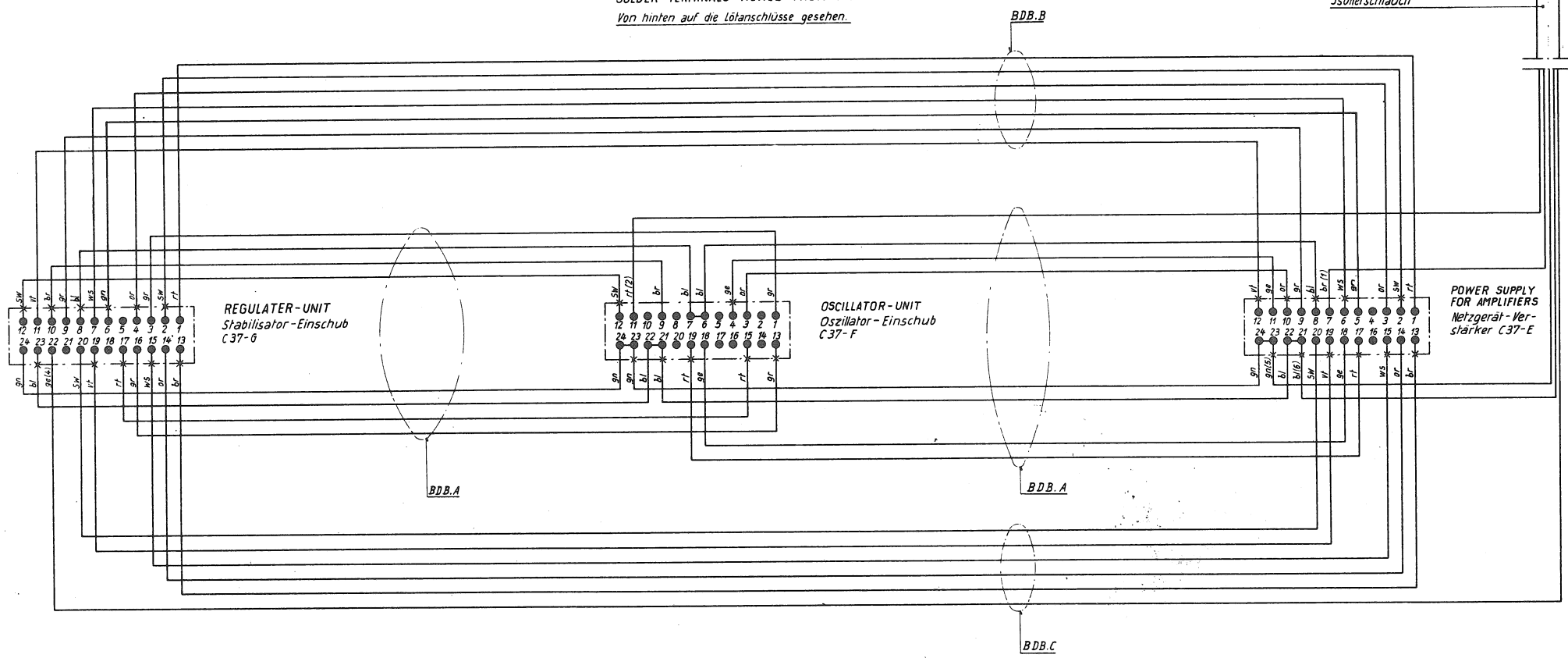

\* Bougierrohr über Lötanschlüsse

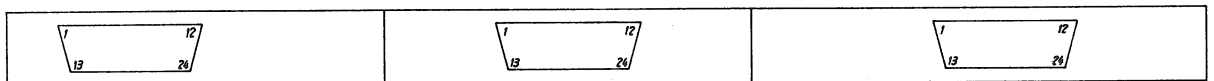

Stück	Pos.	No.	Gegenstand	Mat.	Bemerkung
 <b>Kabelbund</b> zu Kabelkanal					Maßstab /
					Bez. 4.11.60 Dep. 10.3.G.1
REGENSDORF ZÜRICH Ersatz für / Ersetzt durch					Aend.: a) 4.11.60 b) 9.3.61 10.3.G.1 <b>B-C37-BD</b>



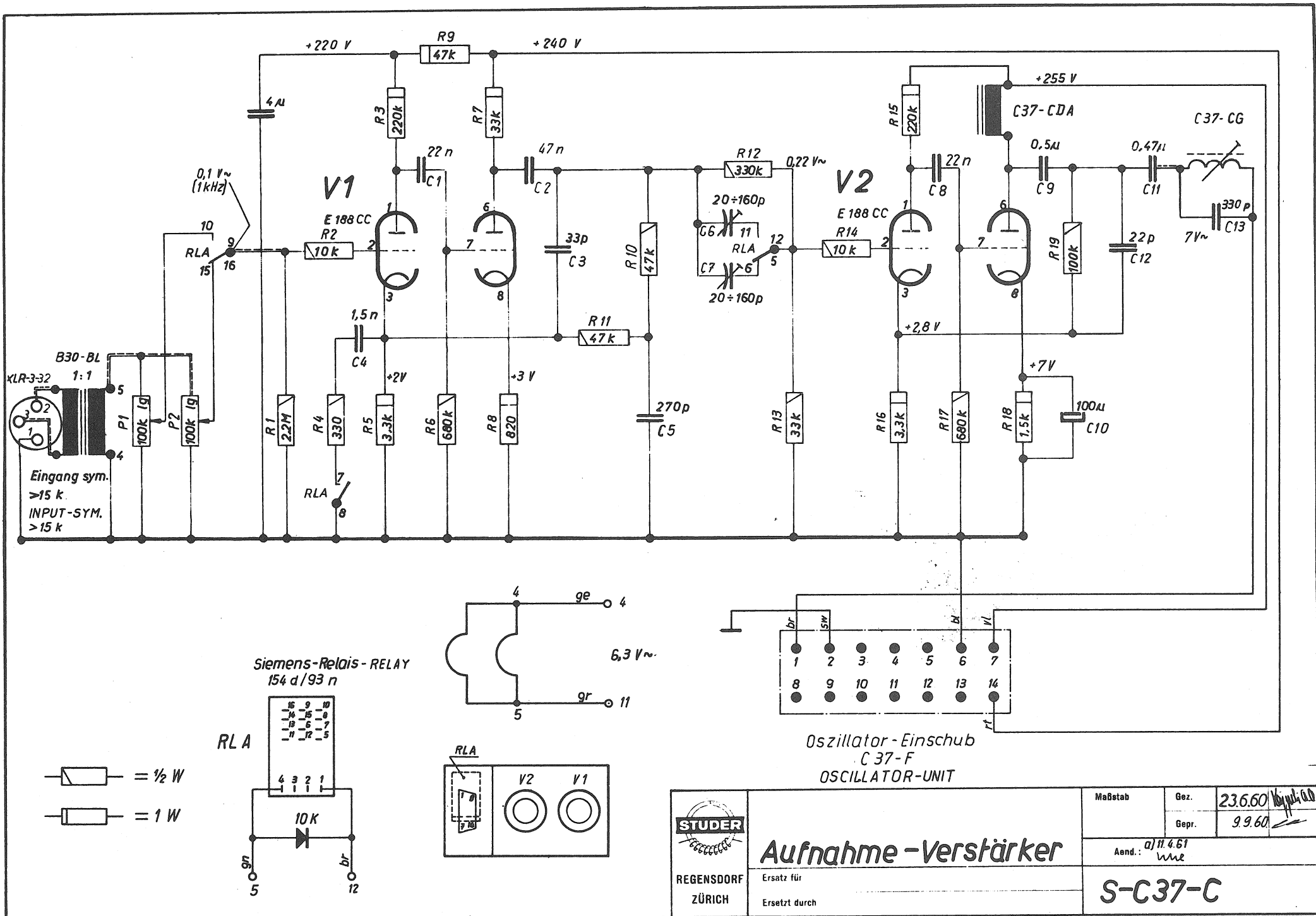

 <b>STUDER</b> REGENSDORF ZÜRICH	<b>Aufnahme-Verstärker</b> Ersatz für Ersetzt durch	Maßstab	Gez.	23.6.60
			Gepr.	9.9.60
		Aend.: a) 11.4.61		
		<b>S-C37-C</b>		

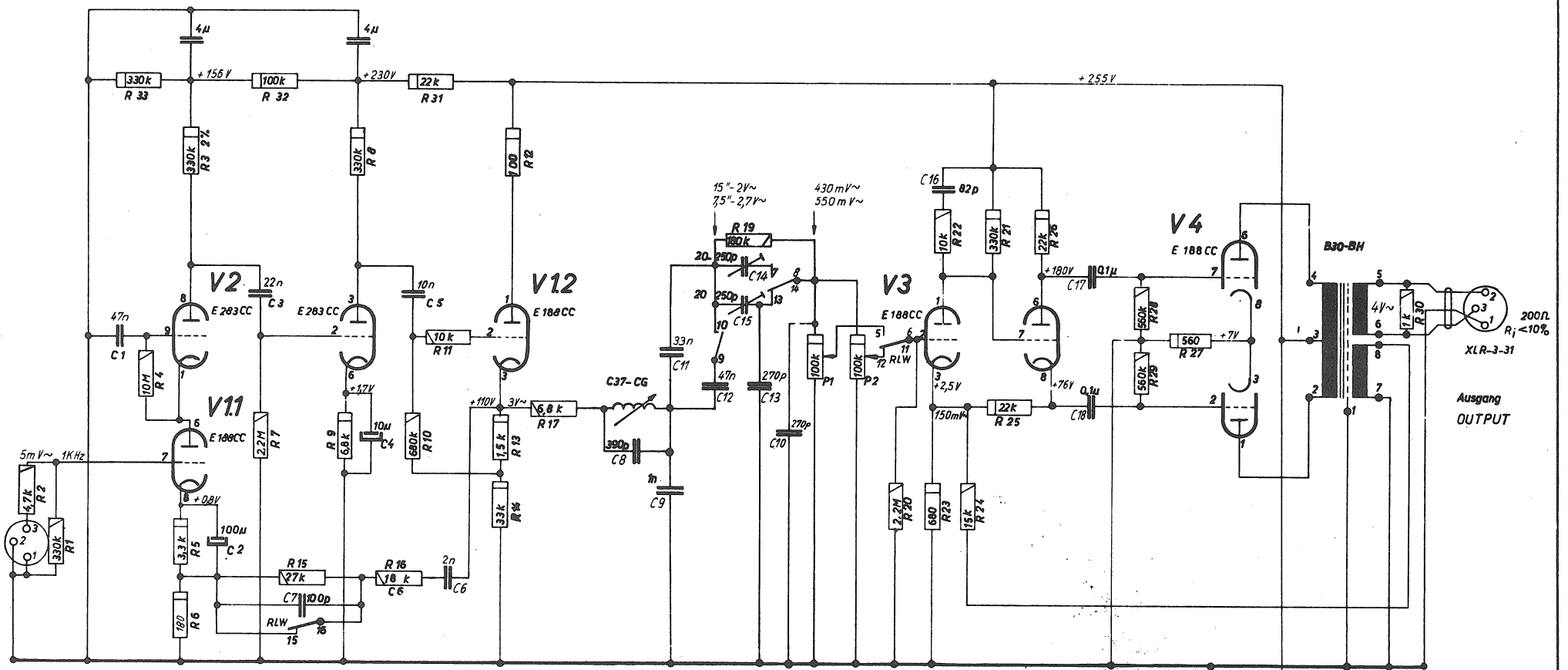

Eingang  
(Wiedergabe-Kopf)  
INPUT  
(PLAYBACK-HEAD)

Siemens-Relais-RELAY  
154 d/93 n

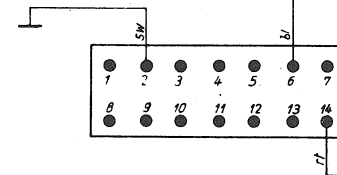
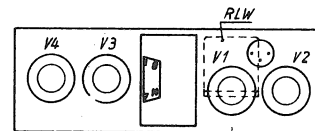
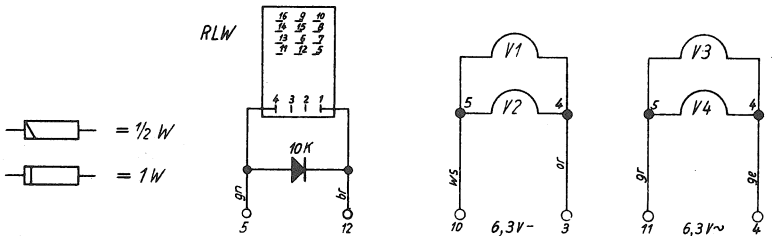

Netzgerät-Verstärker C37-E (K1)  
oder  
Stabilisator-Einschub C37-G (K2)

POWER SUPPLY FOR AMPLIFIERS (TRACK 1)  
OR  
REGULATOR UNIT FOR POWER SUPPLY (TRACK 2)



Wiedergabe-Verstärker

Ersetzt für  
Ersetzt durch

Modell	Bez. 16660
	Supr. 9.9.60
Aend.: a) Rev. 16 115 61 24.5.61	

S-C 37 - D



C 37-EBA

TAPE-TRANSPORT Netzgerät  
POWER-SUPPLY Laufwerk  
C 37-AMC

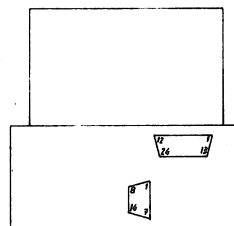
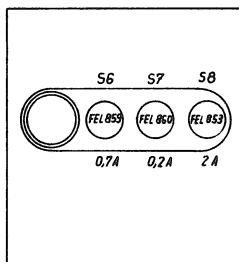
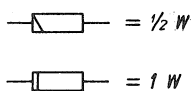
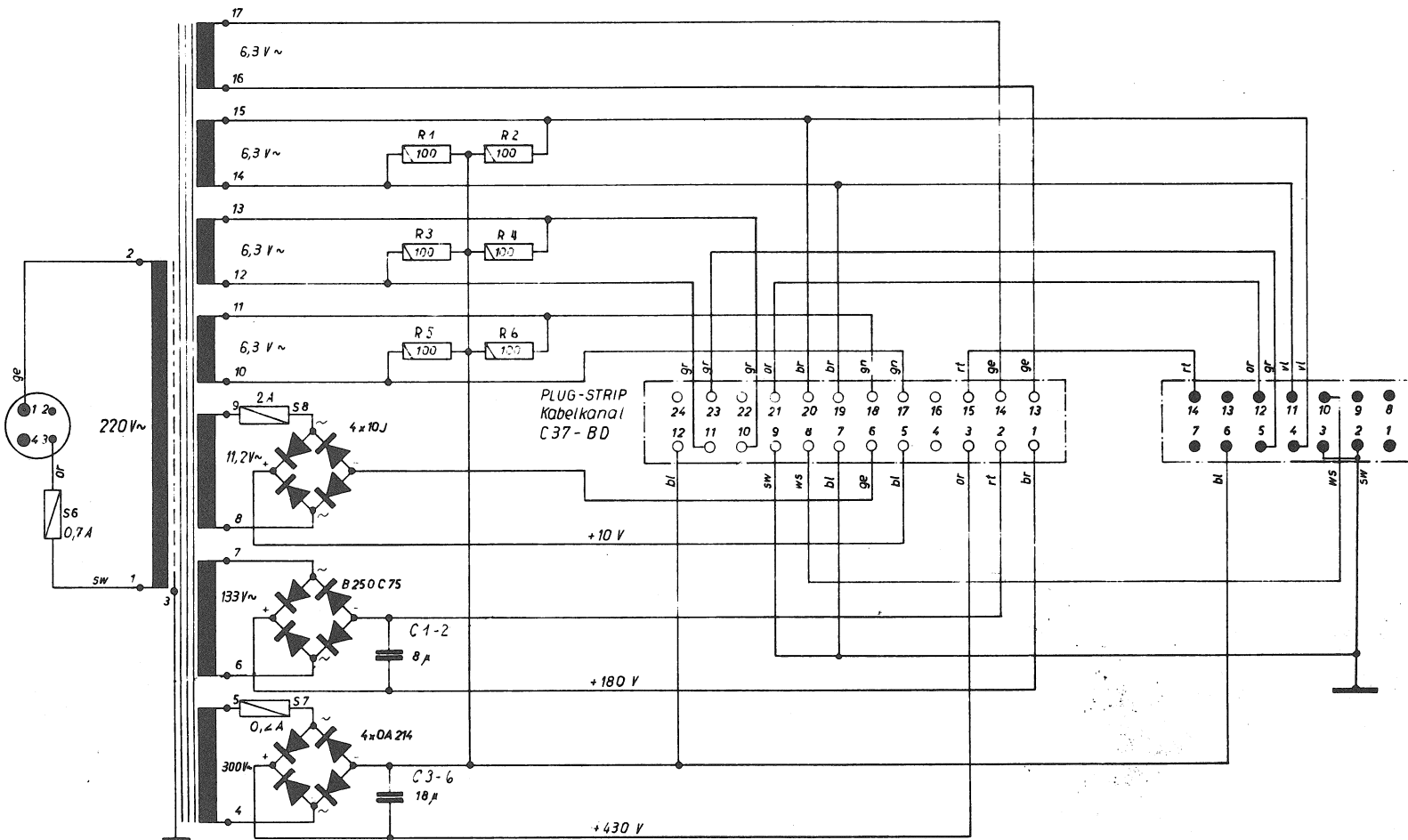

STUDER  
REGENSDORF  
ZÜRICH

Netzgerät-Verstärker

Ersatz für  
Ersetzt durch

Goz. 298.60  
Gepr. 9.9.60  
Aend.: a) 24.2.61  
10/461  
V46

S-C 37-E

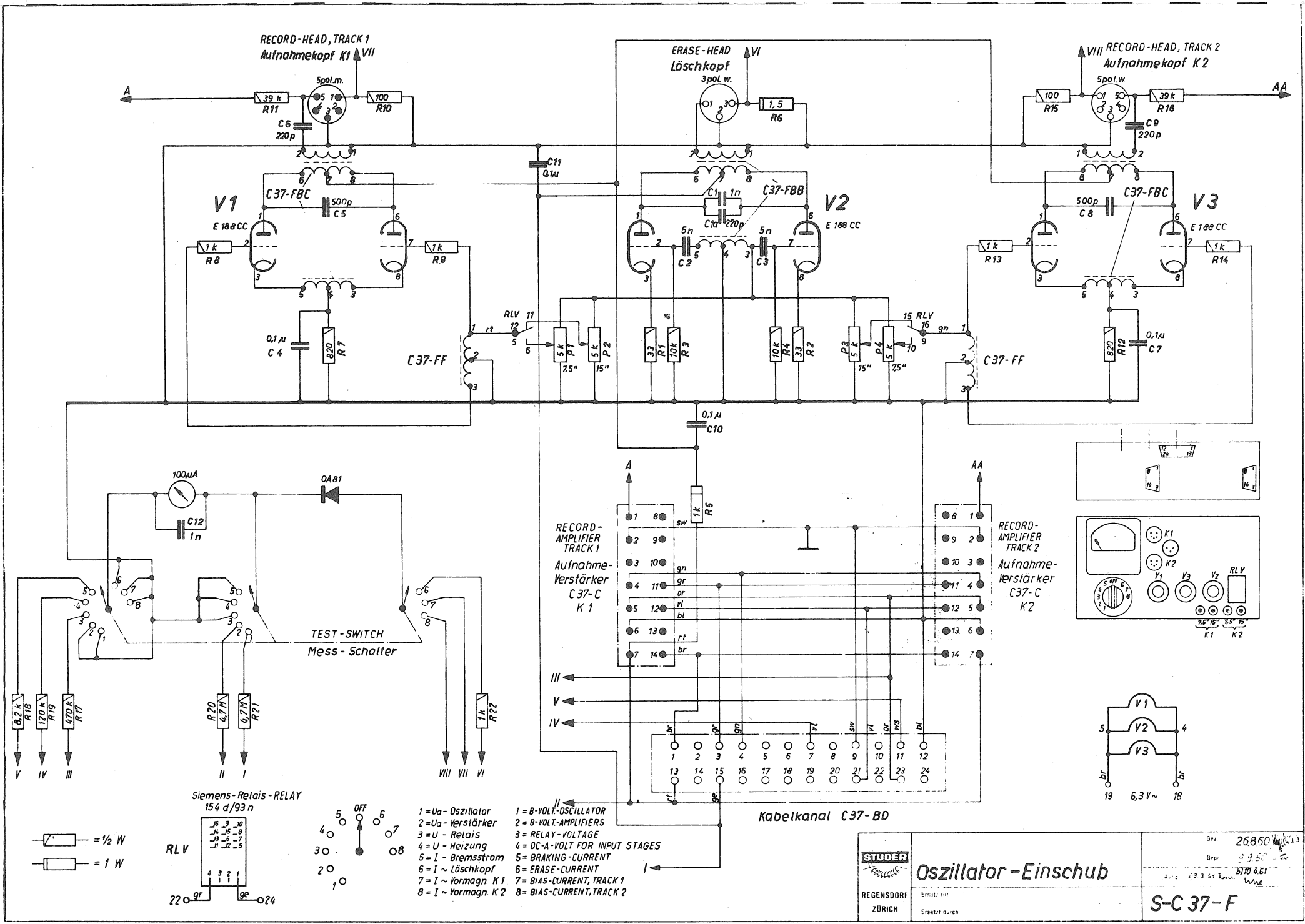

RECORD-HEAD, TRACK 1  
Aufnahmekopf K1 VII

ERASE-HEAD  
Löschkopf VI

VIII RECORD-HEAD, TRACK 2  
Aufnahmekopf K2

V1

V2

V3

TEST-SWITCH  
Mess-Schalter

RECORD-AMPLIFIER  
TRACK 1  
Aufnahme-Verstärker  
C37-C  
K1

RECORD-AMPLIFIER  
TRACK 2  
Aufnahme-Verstärker  
C37-C  
K2

Kabelkanal C37-BD

Siemens-Relais-RELAY  
154 d/93 n

- 1 = U<sub>a</sub> - Oszillator
- 2 = U<sub>a</sub> - Verstärker
- 3 = U - Relais
- 4 = U - Heizung
- 5 = I - Bremsstrom
- 6 = I ~ Löschkopf
- 7 = I ~ Vormagn. K1
- 8 = I ~ Vormagn. K2
- 1 = B-VOLT-OSCILLATOR
- 2 = B-VOLT-AMPLIFIERS
- 3 = RELAY-VOLTAGE
- 4 = DC-A-VOLT FOR INPUT STAGES
- 5 = BRAKING-CURRENT
- 6 = ERASE-CURRENT
- 7 = BIAS-CURRENT, TRACK 1
- 8 = BIAS-CURRENT, TRACK 2

	<b>Oszillator-Einschub</b>		No. 26860 Grp. 9960 670 461
	REGENSDORF ZÜRICH	Ersatz für Ersatz durch	<b>S-C 37-F</b>

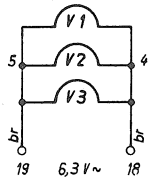
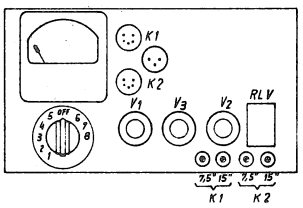
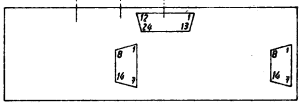
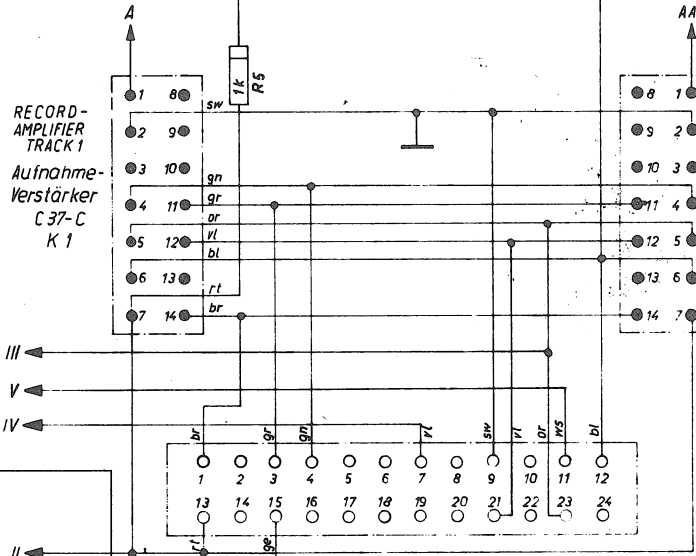
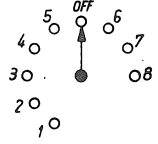
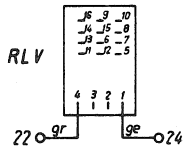
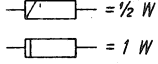

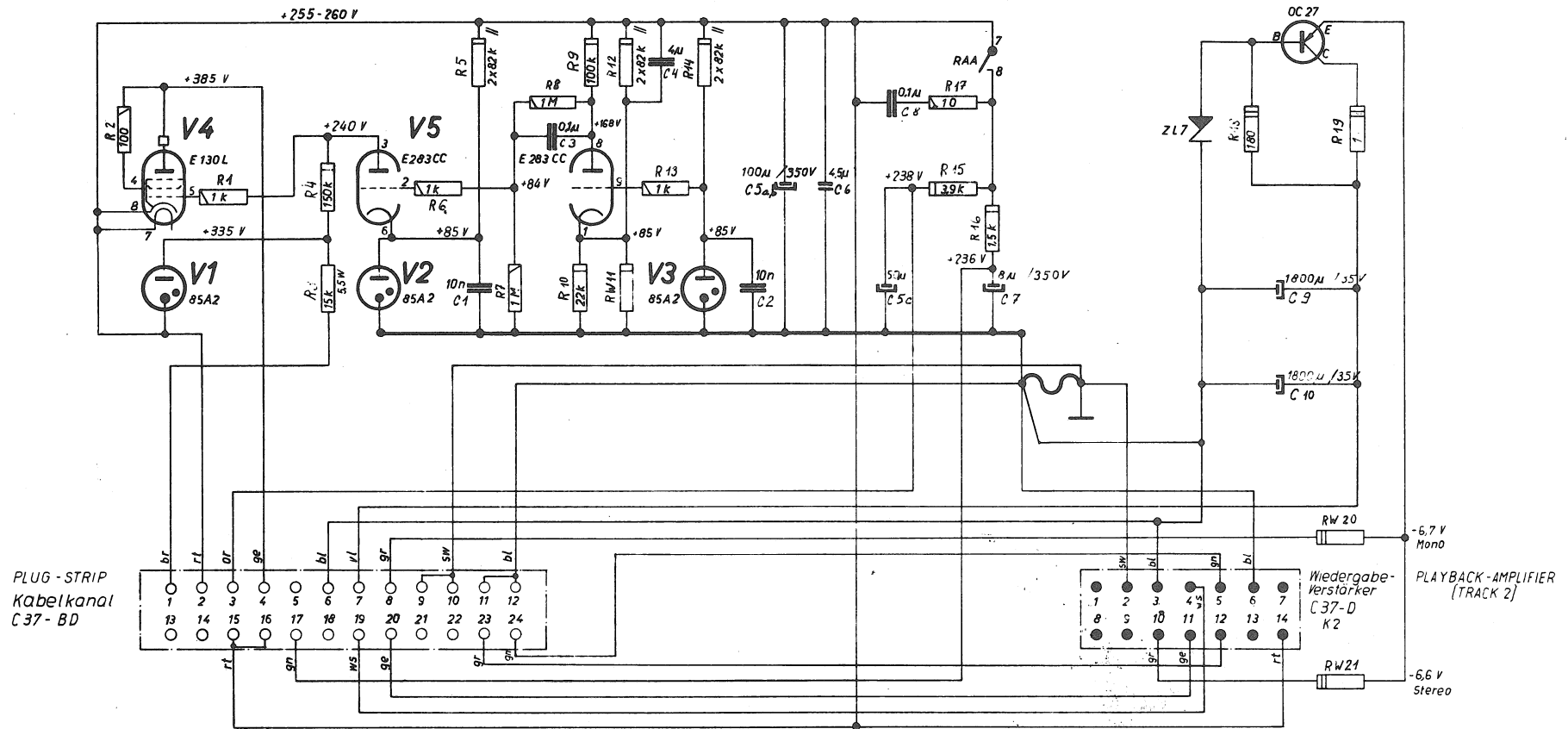

PLUG-STRIP  
Kabelkanal  
C37-BD

Wiedergabe-  
Verstärker  
C37-D  
K2

PLAYBACK-AMPLIFIER  
(TRACK 2)

-6.7 V  
Mono

-6.6 V  
Stereo

Siemens-Relais-RELAY  
154 d/93 n

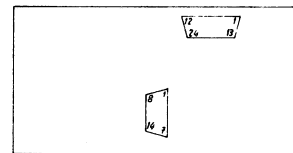
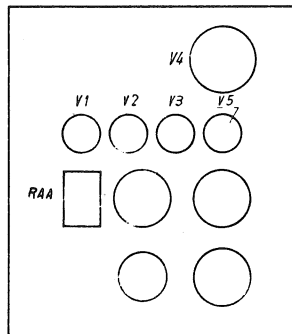
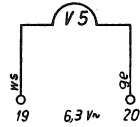
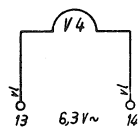
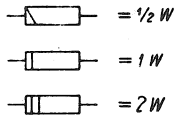
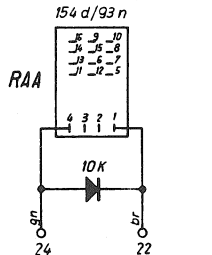

- RW 11 - Abgleich auf 255-260 V
- RW 20 } - Abgleich auf 6.3 V -
- RW 21 }
- RW 11 - ADJUST FOR 255-260 V
- RW 20 } - ADJUST FOR 6.3 V -
- RW 21 }

**STUDER**  
REGENSDORF  
ZÜRICH

**Stabilisator-Einschub**

Ersatz für  
Ersetzt durch

Ver. 31860  
Gepr. 9300  
Aend. 3. 12. 60  
210.4.61/3334

**S-C37-G**

COLOURCODE ON HEAD-LAMINATION  
 Farbbezeichnung auf Kernblech:

Aufnahmekopf = grün  
 Wiedergabekopf = rot  
 RECORD-HEAD = GREEN  
 PLAYBACK-HEAD = RED

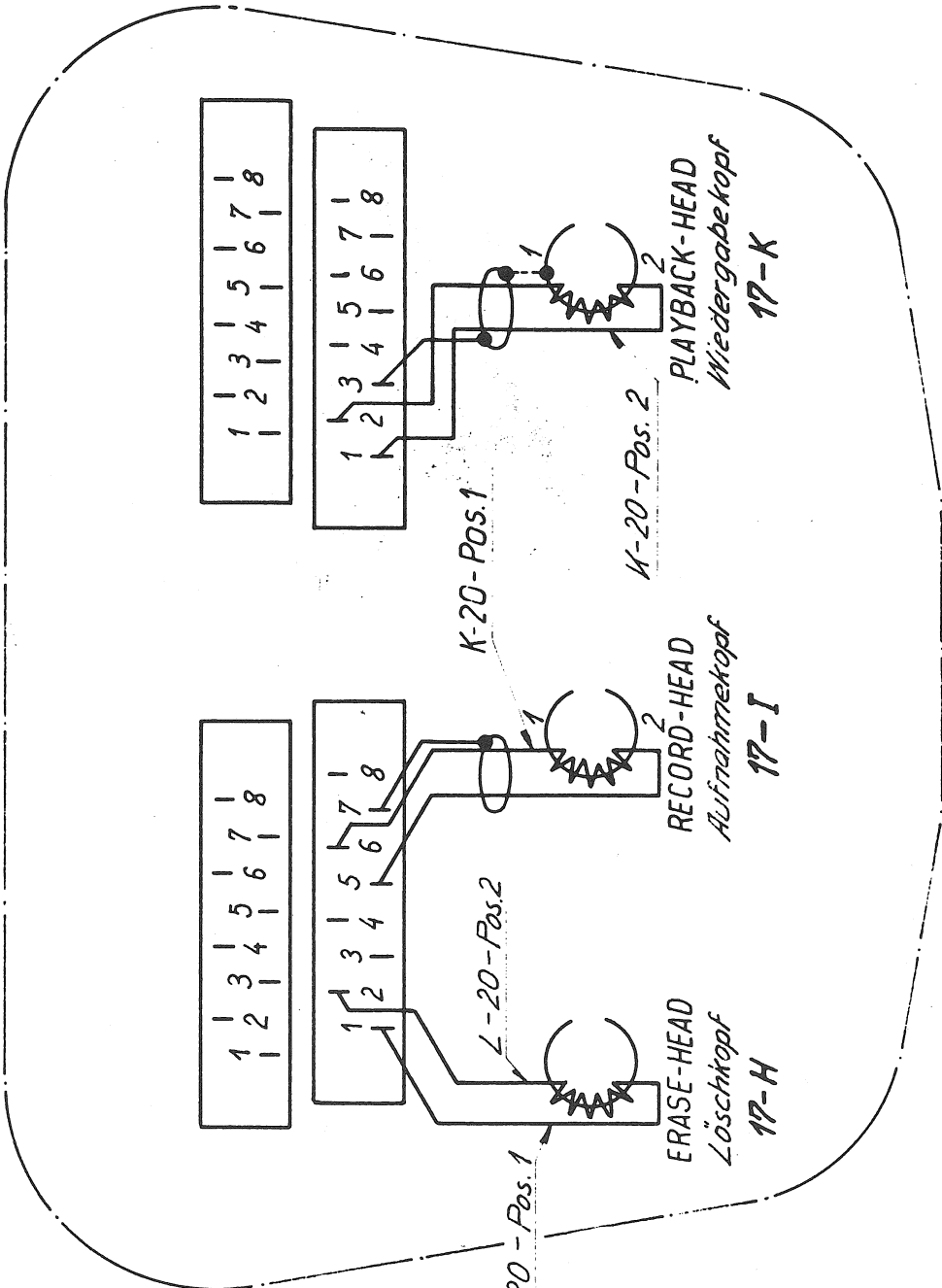
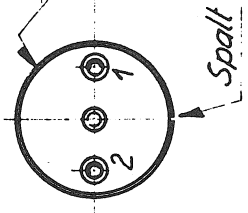

**ATTENTION!**  
 DO NOT APPLY ANY DC

**Achtung!**

Nicht mit Gleichstrom belasten.  
 Vorschrift (Normband) beachten.

Stück	Pos.	No.	Gegenstand	Mat.	Bemerkung
			Kopfträger (Vollspur - Ausf.)	Maßstab %	Gez. 8.9.60 Gepr. 9.3.60 23.3.61
				Aend.: a) 23.3.61 b) 11.4.61 WLR	8.9.60 9.3.60 23.3.61
REGENDSDORF ZÜRICH		Ersatz für			B-20-A
		Ersetzt durch			

Farbbezeichnung auf Kernblech:  
 Aufnahmekopf = grün  
 Wiedergabekopf = rot

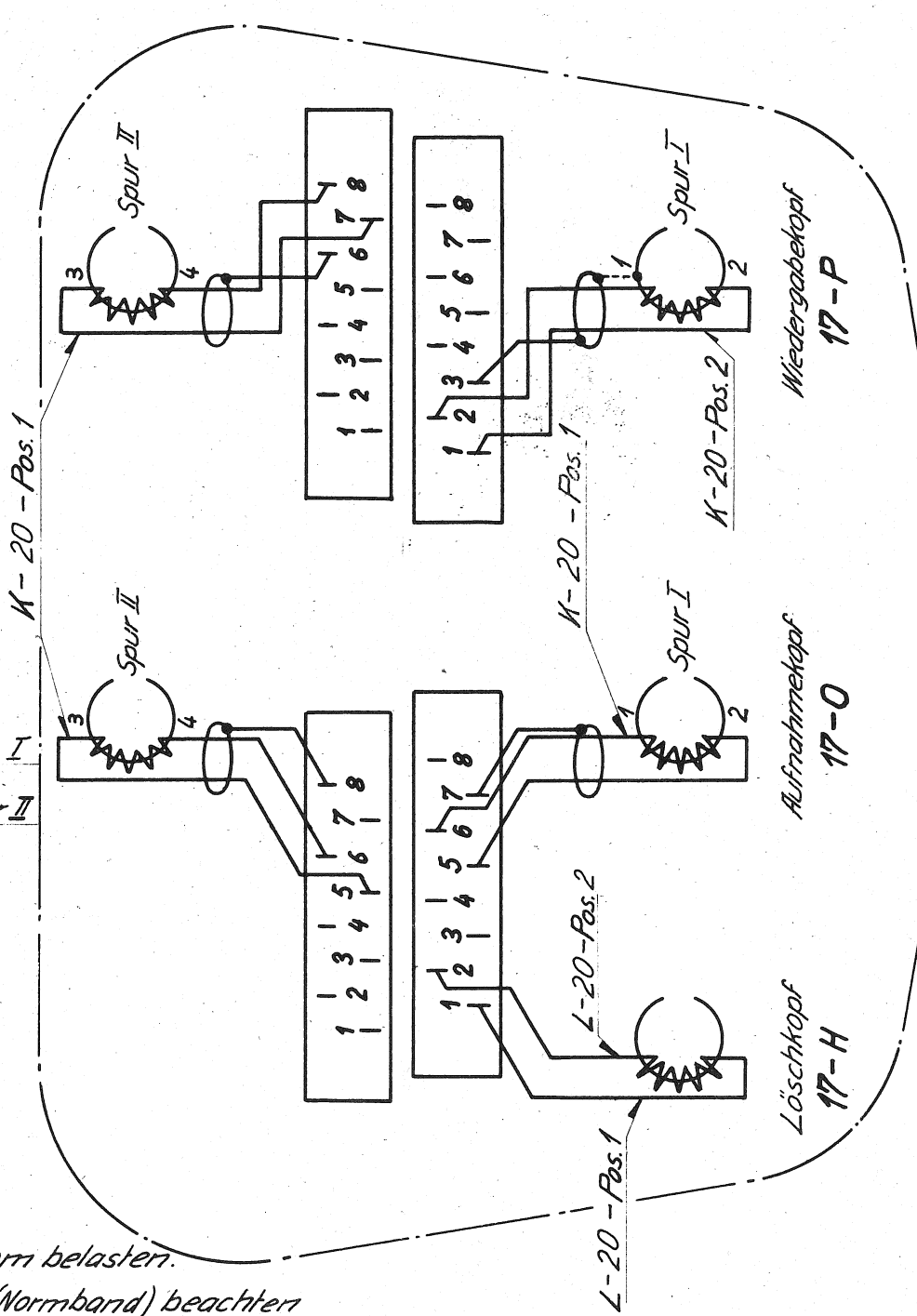
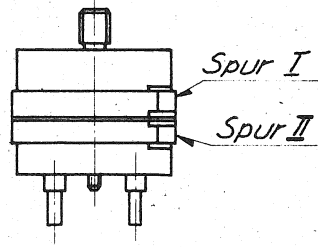
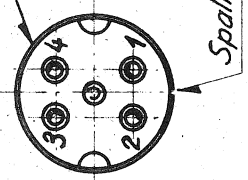

**Achtung !**

Nicht mit Gleichstrom belasten.  
 Vorschrift (Normband) beachten

Stück	Pos.	No.	Gegenstand	Mat.	Bemerkung
			<b>Kopfträger (Stereo - Ausf.)</b>	Maßstab 1/1	Gez. 6.9.60. <i>Kehrl</i>
				Gepr. 9.9.60. <i>23.3.61</i>	
				Aend.: a) 23.3.61 b) 11.4.61	
REGENDORF ZÜRICH		Ersatz für			<b>B-20-C</b>
		Ersetzt durch			

**EMT WILHELM FRANZ GMBH**

LANDSTRASSE 85 · WETTINGEN (AG) SWITZERLAND · PHONE: BADEN (056) 60550 · CABLES: EMTFRANZWETTINGEN

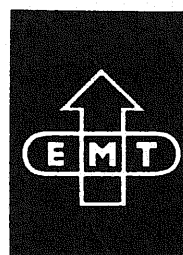

Printed in Germany