

CONTENTS

|   | Page |
|---|------|
| 1. Introduction   | 3    |
| 1.1 General   | 3    |
| 1.2 Removing the top panel                                  | 3    |
| 1.3 Replacing the top panel                                 | 3    |
| 1.4 Threading the tape                                      | 3    |
| 2. Maintenance  | 4    |
| 2.1 Cleaning the tape path                                  | 4    |
| 2.2 Lubrication   | 4    |
| 3. Mechanical checks and adjustments                        | 5    |
| 3.1 Checking the braking force                              | 5    |
| 3.2 Checking the clearance on the brake arm                 | 5    |
| 3.3 Adjusting the braking force                             | 6    |
| 3.4 The brake solenoid                                      | 6    |
| 3.5 The pinch roller solenoid                               | 7    |
| 3.6 The pinch roller  | 7    |
| 3.7 The reel motors   | 7    |
| 3.8 The tape tension arms                                   | 8    |
| 3.9 The photo-electric sensors                              | 9    |
| 3.10 The thrust bearings                                    | 9    |
| 4. Changing and adjusting the heads                         | 10   |
| 5. Changing lamps   | 10   |
| 5.1 Changing mode button lamps                              | 10   |
| 5.2 Changing the photo-electric stop lamp                   | 10   |
| 6. Changing the power supply transformer tapplings          | 11   |
| 7. Electrical circuits                                      | 12   |
| 7.1 Motor   | 12   |
| 7.2 Oscillator  | 12   |
| 7.3 Checking the record response curve                      | 14   |
| 7.4 Checking the playback response curve                    | 14   |
| 7.5 Changing from NAB correction to IEC correction, 2 track | 15   |
| 8. Electrical adjustments                                   | 16   |
| Block diagram   | 18   |
| High level in STOP, on function control logic and sensor.   | 20   |
| Circuit diagrams and printed boards                         | 21   |
| Modifications   | 22   |
| Main board circuit diagram. From serial No. 237245          | 31   |
| Function control logic circuit. From serial No. 2372800     | 32   |

1. INTRODUCTION

1.1 GENERAL

Only HL (High output/Low noise) tape should be used for recording. Make sure that the heads and tape path are clean.

To check the heads, simply remove the two head covers. They should be pulled straight off.

When electrical adjustments are to be made, the right side panel and the base panel must be removed.

1.2 REMOVING THE TOP PANEL

Pull the top head cover off and remove the two screws beneath it as shown in Figure 1.1. Remove the two screws in each side panel and pull the panels off.

Remove the screw in the angle bracket holding the front panel (one on each side) and remove the bracket as shown in Figure 1.1. Twist the thin part of the fork on the right tape-tension arm anti-clockwise to allow the top panel to pass over the arm. Lift the panel off.

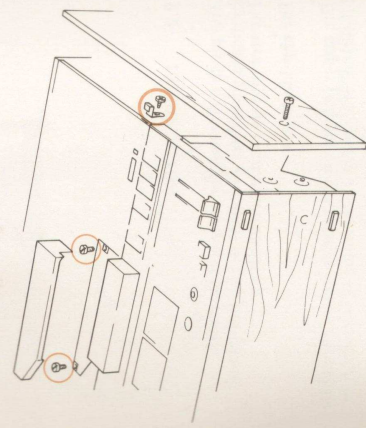

Fig. 1.1 Removing the top panel

1.3 THREADING THE TAPE

The 10XD has a tape guide post adjacent to the left tape tension arm. It is important for the tape to be threaded past this post as shown in Figure 1.2.

This post ensures that the correct tension is achieved and that the servo brake operates correctly on the left tape tension arm.

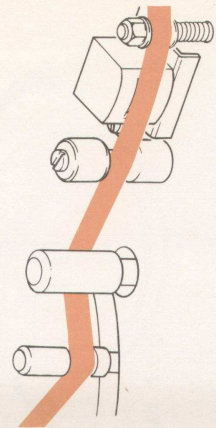
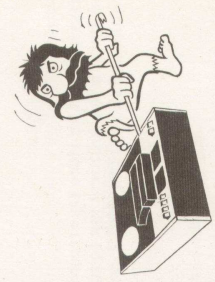

Fig. 1.2 Threading the tape



## 2. MAINTENANCE

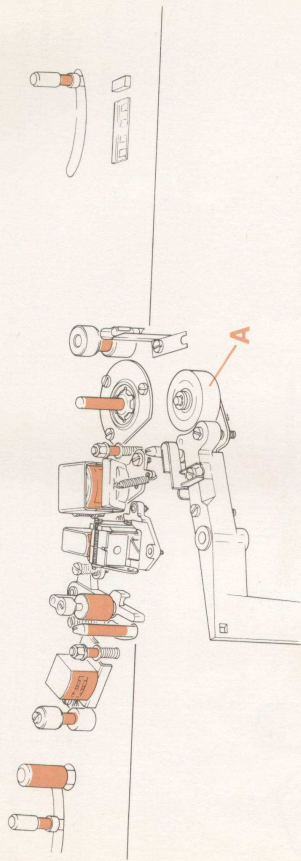

Fig. 2.1 Cleaning the tape path

### 2.1 CLEANING THE TAPE PATH

It is important that the tape path is clean before adjustments are made. The tape tension arms must also be cleaned. If the heads or guide posts have been adjusted, the tape path must be de-magnetized.

Cleaning should be carried out with cotton-bud sticks (Q tips) moistened with *pure alcohol or methylated spirits*. A special cleaning kit called "Tandberg Professional Tape Head Cleaner" is also available.

Aerosol sprays indented for video tape recorders may be used, but it is not sufficient just to spray the parts; cotton-bud sticks must also be used.

Obstinate deposits on guide posts should be first well softened and then removed with the aid of a toothpick.

The pinch roller A should be cleaned if the tape runs unevenly or if there are visible deposits on the roller (4 to 6 times a year should be sufficient, even if the tape recorder is much used). Make sure that the pinch roller is dry after cleaning.

### 2.2 LUBRICATION

The pinch roller and the flywheel have self-lubricating bearings and must not be lubricated. The reel motors need no lubrication.

The capstan motor

The upper bearing on the capstan motor should be lubricated after every 1,500 hours of operation or at every regular service check.

Remove the motor pulley and apply only one drop of CHRONOSYTH 1/3 oil from Klibber.

The oil can be obtained from our service department.

## 3. MECHANICAL CHECKS AND ADJUSTMENTS

### 3.1 CHECKING THE BRAKING FORCE

The tape recorder should be in the STOP mode or the POWER switch should be off.

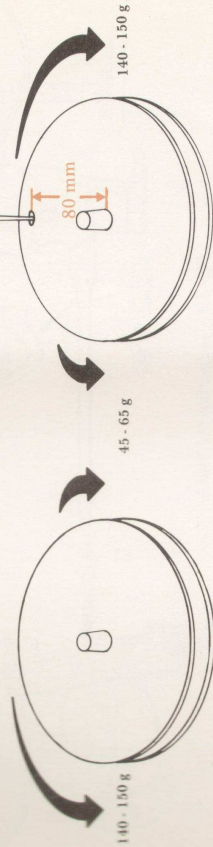

Fig. 3.1 Checking the braking force

A 7" reel with a hole drilled in it 80 mm from the hub hole is required together with a torque gauge. Lay the reel on the left or right turntable (see Figure 3.1).

Insert the leg of the torque gauge into the drilled hole and try to turn the reel with the gauge. When the gauge overcomes the braking force, note the force in gauges. The force should correspond to that shown in Figure 3.1. Check both brakes in both directions.

### 3.2 CHECKING THE CLEARANCES ON THE BRAKE ARM

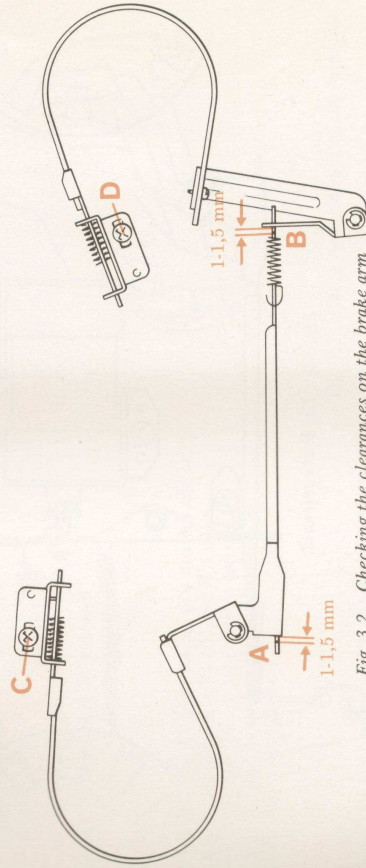

Fig. 3.2 Checking the clearances on the brake arm

Before adjusting the braking force, check that the clearances A and B in Figure 3.2 are between 1 and 1.5 mm. The clearances can be adjusted with screws C and D when the machine is in the STOP mode or the POWER is switched off.

If the braking force is not correct it should be adjusted as explained in 3.3, but the check described in 3.2 should be carried out first.

### 3.3 ADJUSTING THE BRAKING FORCE

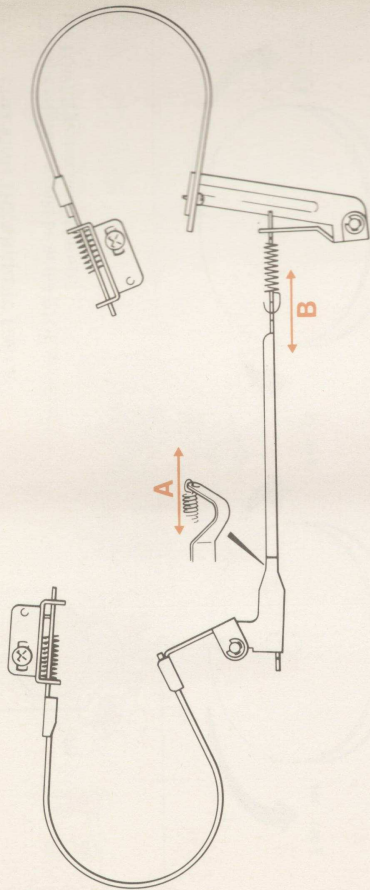

Fig. 3.3 Adjusting the braking force

Adjust the braking force on the left turntable by bending the arm A in Figure 3.3 to make it longer or shorter. The tighter the spring and the greater the braking force.

Adjust the braking force on the right turntable by moving spring B to another notch as shown in Figure 3.3. After adjusting the braking force ensure that the brake bands are being applied (see next Paragraph).

### 3.4 THE BRAKE SOLENOID

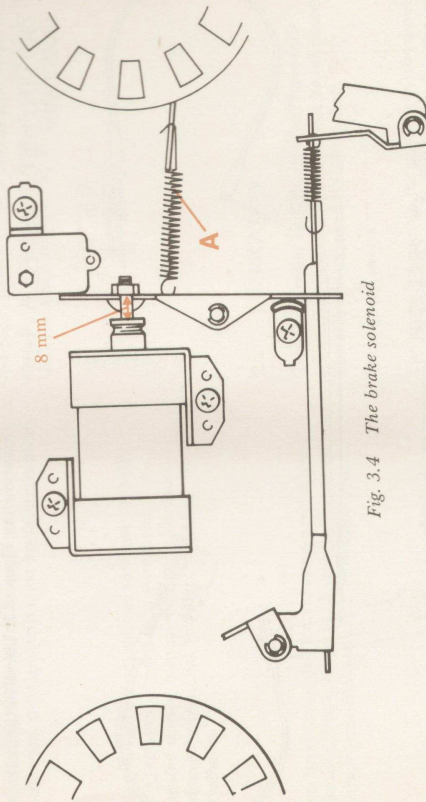

Fig. 3.4 The brake solenoid

The brake solenoid releases the brake bands for all operational modes except STOP. When the brake solenoid is changed it is, as a rule, not necessary to re-adjust the nut on the armature.

The nut on the armature is adjusted so that the brake band is released and the microswitch is released in PLAY. In STOP, spring A shown in

### 3.5 THE PINCH ROLLER SOLENOID

When the pinch roller solenoid is changed it is very important to check (and if necessary adjust) the distance shown in Figure 3.5. The distance must be between 0.5 and 1 mm when the machine is in PLAY. The corresponds to a pinch roller/capstan pressure of between 1.2 and 1.4 kg.

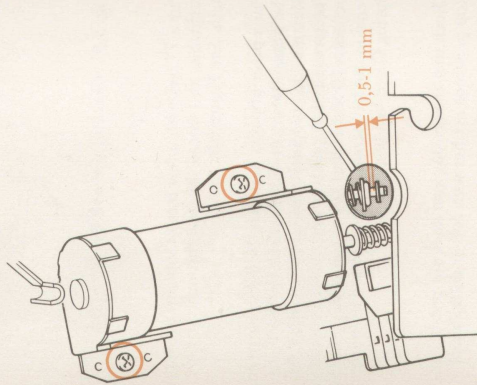

Fig. 3.5 The pinch roller solenoid

Check the distance with the aid of a dentists mirror when the machine is in PLAY, and if it is not correct slacken the screws ringed in colour in Figure 3.5 and move the solenoid brackets to obtain the correct distance.

Check that the bracket which operates the microswitches does not come into contact with the switch body in PLAY — there must be a small clearance.

To check the pinch roller pressure simply place a gauge on the pinch roller shaft when the machine is in PLAY. Press away from the capstan and when the pinch roller stops, the indication on the gauge should be approximately 1.2 to 1.4 kg.

### 3.6 THE PINCH ROLLER

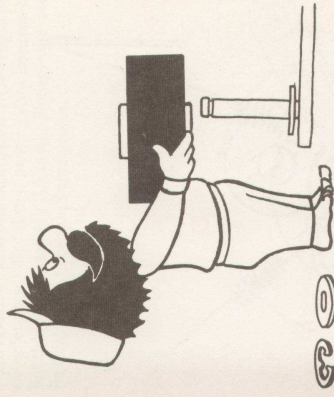

Fig. 3.6 The pinch roller

When the pinch roller is changed make sure that the same number of "turbax" washers are on each side of the roller.

Then check that the tape runs in the middle of the roller without flickering on neither side of the roller.

### 3.7 THE REEL MOTORS

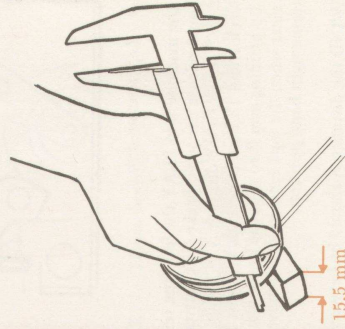

Fig. 3.7 Checking the height of the turntable

When a reel motor is changed, the distance from the chassis plate to the turntable surface should be measured (see Figure 3.7) before the turntable is removed. The turntable should be replaced so that this distance is maintained, or place a spacer between the chassis plate and the turntable.

### 3.8 TAPE TENSION ARMS

**NOTE!** These adjustments affect each other. After each adjustment check that the other settings are still correct.

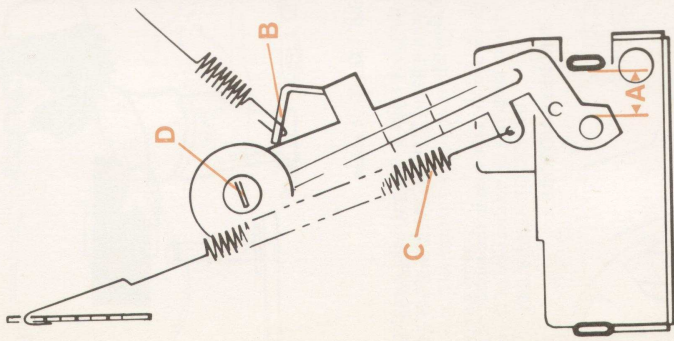

Fig. 3.8 Left tape tension arm

When the machine is in **PLAY** the left tape tension arm should release the servo brake (left turntable should be free) when the distance **A** in Figure 3.8 is between 2 and 13 mm. If necessary, adjust the brake by bending arm **B** so that the brake band is lifted clear when the tape tension arm is moved to its extreme right hand position.

In **REWIND** the distance **A** should be between 0 and 4 mm. This distance can be adjusted by moving spring **C** (Figure 3.8) down one or two notches to slacken it. Normally the spring is on the top notch.

#### Height adjustment for tape tension arms.

The height of each tape tension arm can be adjusted by screw **D** in Figure 3.8 (similar screw on right side). The height should be adjusted so that the tape does not rub on the outer edges of a 10" reel. Make sure that the reel is not necessary distorted so that it has a pronounced bias as it rotates.

### Hold-back tension.

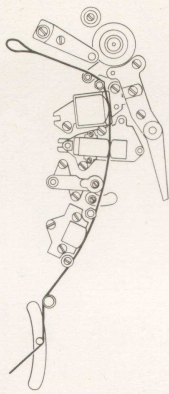

Fig. 3.9 Checking the hold-back tension

Put a 7" reel with a few feet of tape on the supply turntable, and thread the tape through the tape path. See Figure 3.9.

Put a piece of paper between the light source and the photo-transistor. Set the deck to **PLAY**. Measure the hold-back tension with a gauge. The force required to pull the tape through should be between 70 and 100 g. The absolute value of the tension can be increased or decreased by moving spring **C** and bending arm **B**.

Check that the sensing arm does not rest in end-stop positions neither with full or with almost empty supply reel.



### 3.9 PHOTO-ELECTRIC SENSORS

The machine has one photo-electric sensor near the counter to control the braking sequence, and another sensor adjacent to the flywheel to control the speed.

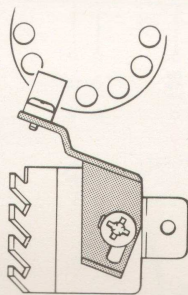

Fig. 3.10 Sensor near the counter

Adjustments to these sensors are not critical. They should be adjusted so that the light beam is broken, but adjust the sensor near the counter to maximum clearance to the belt. See Figure 3.10.

### 3.10 THRUST BEARINGS

The thrust bearing **A** for the capstan motor (Figure 3.11) should not press the motor spindle completely in. The thrust bearing should press only lightly (approximately 0.5 mm). The spindle and the bearing should contain some grease.

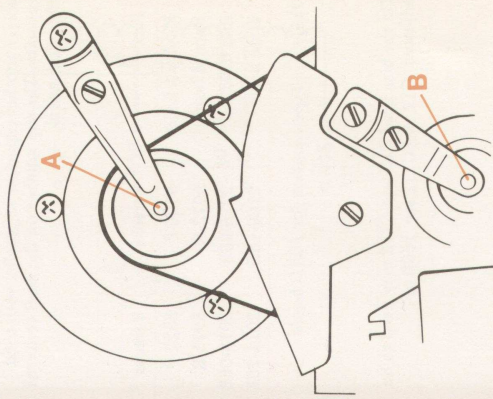
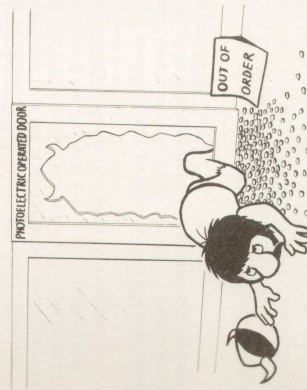

Fig. 3.11 Thrust bearings

The thrust bearing **B** for the capstan should only touch the capstan without exerting any pressure.



#### 4. CHANGING AND ADJUSTING THE HEADS

All the components are on the Main board A1.

Do not use heads from other models on the 10XD.

On the erase head and the bias head there are labels giving the total capacity.

When the erase head is changed, C13 and C113 may need to be adjusted to retain the same total capacity. C13 and C113 are 120 pF. If necessary, solder another capacitor in parallel with total capacity. The top number on the label concerns the left channel.

| Part          | 4 tracks | 2 tracks * |
|---------------|----------|------------|
| Playback head | 5606-P   | 5822-P     |
| Record head   | 5972-R   | 5971-R     |
| Bias head     | 2276-05B | 2013-06B   |
| Erase head    | 2160-18E | 2014-20E   |

Table 1 Type numbers for 10XD heads

On the bias head C12 and C112 may need to be adjusted. C12 and C112 are 1500 pF.

When ordering heads, use the type numbers in Table 1.

\* When changing the heads from 4-track to 2-track the resistor R24-R124 (2.7 k ohm, 4-track) have to be replaced with 2.2 k ohm (2-track).

#### 5. CHANGING LAMPS

##### 5.1 CHANGING MODE BUTTON LAMPS

When one of the lamps on the logic board needs to be changed, the button can be pulled off with the aid of a screwdriver (see Figure 5.0).

NOTE! Insert something soft between the screwdriver and the panel to avoid damage.

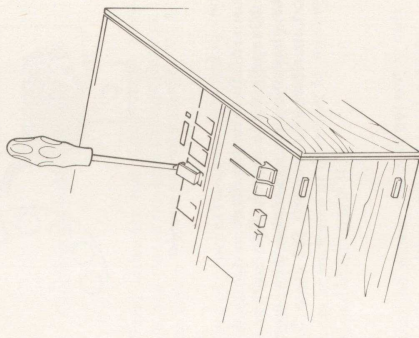

Fig. 5.1 Changing mode button lamps

##### 5.2 CHANGING THE PHOTO-ELECTRIC END STOP LAMP

Put the machine into the PLAY mode. Press the lamp down into the screen until the machine goes into the STOP mode. The screen can also be bent sideways if the machine does not stop when the lamp has reached the bottom of the screen.

Some machines may go into the STOP mode when leader tape passes the lamp, but this is just a coincidence. The machine should stop when all the tape has passed the lamp.

The base resistor on Q101 can be changed. A larger value, 4.7 M ohm for example, may be required to make the stop work, while a smaller value, 2.2 M ohm 2.2 M ohm may be required if the stop is too sensitive. The resistor arc on the logic board.

#### 6. CHANGING THE POWER SUPPLY TRANSFORMER TAPPINGS

Since the machine employs a photo-electric sensor for speed regulation, the speed is not dependent on the power frequency.

To change the wiring of the power supply transformer to suit another power supply voltage, see Figures 4.0, 4.1, 4.2, and 4.3. The power lead must be connected to the primary of the transformer as shown in the relevant Figure.

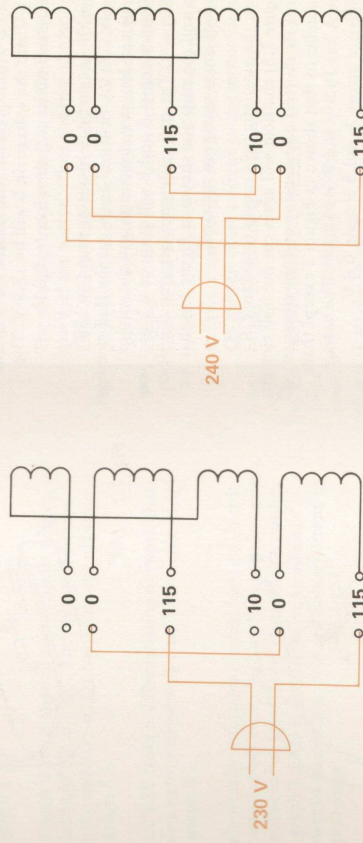
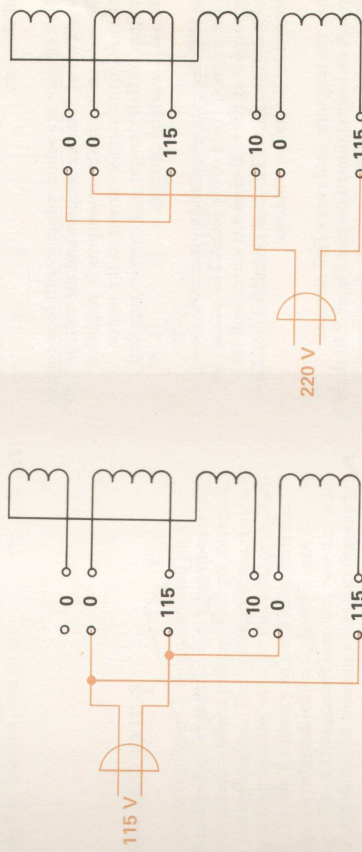

## 7. ELECTRICAL CIRCUITS

### 7.1 MOTOR

The motor is a brushless d.c. motor. Hall elements and transistors replace brushes and commutators. The Hall elements are mounted on a stator that has four windings. The rotor is a powerful permanent magnet.

#### Hall elements

A Hall element is a semiconductor with four connections. Two of these are outputs and the voltage difference across these two outputs is amplified by transistors to supply current to the motor windings. A Hall element must also be supplied with a d.c. working current.

The Hall elements are placed so that they are cut by the magnetic field of the rotor. The voltage on the outputs of the Hall elements varies with the position of the rotor. The Hall elements are not influenced by the motor windings.

When the magnetic field cuts a Hall element through its longest dimension (see Figure 7.0) there will be no voltage difference across the outputs A and B. A typical voltage on A and B for this situation will be 18.5 V. 18.5 V is dependent on the value of the resistors R1 and R2.

When the magnetic field moves clockwise by 90° and cuts the Hall element across its shortest dimension (see Figure 7.1) the voltage difference across A and B will be greatest. The voltage on A will be 18.1 V and the voltage on B will be 18.9 V. The voltage difference will therefore be 0.8 V.

When the magnetic field moves round to 180° (Figure 7.2) the field will again cut the Hall element through its longest dimension and the voltage difference across A and B will again be 0 V, as it was in Figure 1. The only difference between this situation and the situation shown in Figure 1 is that the poles of the magnets are reversed.

When the magnetic field moves round to 270° (Figure 7.3) the field will again cut the Hall element across its shortest dimension and the situation will be similar to that shown in Figure 2 except that here A has 18.9 V and B has 18.1 V. The voltage difference across A and B is again 0.8 V.

As the magnetic field moves into the 90° position or the 270° position the voltage across A and B will gradually increase from 0 V to 0.8 V. As the field moves into the 0° position or the 180° position the voltage across A and B will gradually decrease from 0.8 V to 0 V.

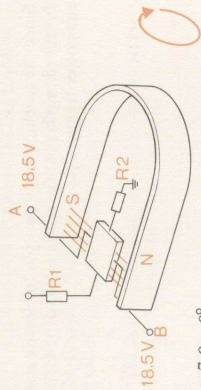

Fig. 7.0 0°

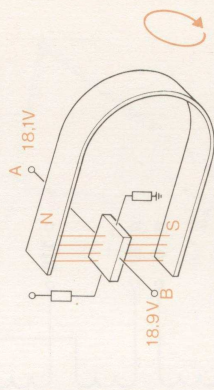

Fig. 7.1 90°

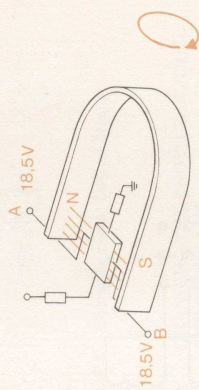

Fig. 7.2 180°

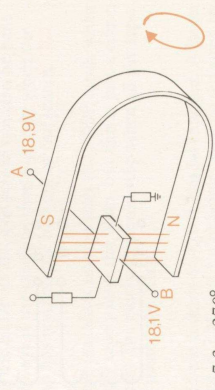

Fig. 7.3 270°

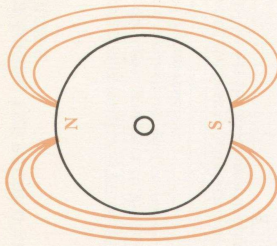

Fig. 7.4 The rotor seen from the top with its magnetic fields

Figure 7.5 is a basic circuit diagram of the motor with its control components. When the North pole of the rotor is opposite the Hall element W the voltage across its A and B outputs will be greatest i.e. the same as in Figure 7.1 (0.8 V). This causes transistor W to deliver the maximum current to its winding and the rotor's North pole is drawn towards the W Hall element and goes towards the Y Hall element the current in the W winding reduces and transistor X begins to conduct, and so on.

#### MOTOR REGULATION

The motor regulation principle is based on a toothed flywheel that interrupts a light beam and thereby generates light pulses which are detected by a photo-detector. The pulses are converted to a d.c. voltage and the value of this voltage is determined by the frequency of the pulses. This d.c. voltage is compared with a fixed reference d.c. voltage. The difference between the two d.c. voltages is amplified 30 times in a comparator which then regulates the current supply to the motor.

#### SPEED CONTROL

Look at Figure 7.6 while you read this paragraph. The photo-detector delivers a peak-clipped sine wave (see graph 1) that is amplified in Q1 so that the output of Q1 is approximately a square wave (see graph 2).

The square wave is applied to a Schmitt trigger consisting of Q2 and Q3. The voltage delivered from the collector of Q3 has a fast cut-off time (see graph 3).

C3 and R10 form a differentiating network that supplies narrow negative pulses to the base of Q4 (see graph 4).

Q4 is normally saturated (turned hard on) but it goes into cut-off every time a negative pulse arrives. The collector of Q4 delivers short positive pulses (see graph 5). Q5 is connected as an emitter follower to enable it to feed sufficient current to the next stage.

Q7 ensures that the working voltage across Q8 is stable.

Q8 charges C4. The charging current is determined by resistors located in the speed control circuit which are connected to the emitter of Q8.

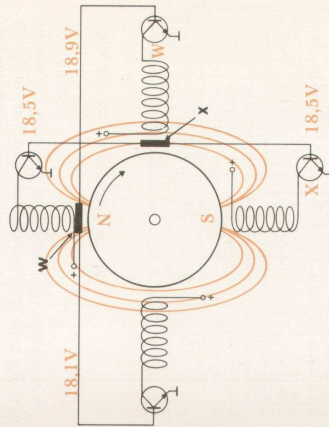

Fig. 7.5 The basic circuit diagram of the motor

The positive pulses (graph 5) on the base of Q6 ensure that Q6 goes into saturation (turns hard on) to discharge C4. This causes the collector of Q6 to deliver sawtooth pulses (see graph 6). These sawtooth pulses are applied to the input, pin 6, of  $\mu$ A747 via R20-R21 and R22. This half of the I.C. circuit is a low pass filter which converts the pulses to d.c. The output, pin 10, is normally about 6 V d.c. This output is connected to the input, pin 1, of the other half of the I.C. circuit. The other input, pin 2, has a stable 6 V d.c. applied to it.

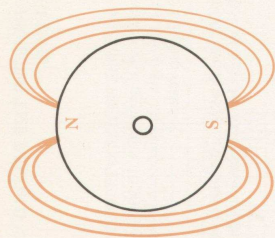

Fig. 7.4 The rotor seen from the top with its magnetic fields

Figure 7.5 is a basic circuit diagram of the motor with its control components. When the North pole of the motor is opposite the Hall element W the voltage across its A and B outputs will be greatest i.e. the same as in Figure 7.1 (0.8 V). This causes transistor W to deliver the maximum current to its winding and the rotor's North pole is drawn towards the W Hall element and goes towards the Y Hall element the current in the W winding reduces and transistor X begins to conduct, and so on.

#### MOTOR REGULATION

The motor regulation principle is based on a toothed flywheel that interrupts a light beam and thereby generates light pulses which are detected by a photo-detector. The pulses are converted to a d.c. voltage and the value of this voltage is determined by the frequency of the pulses. This d.c. voltage is compared with a fixed reference d.c. voltage. The difference between the two d.c. voltages is amplified 30 times in a comparator which then regulates the current supply to the motor.

#### SPEED CONTROL

Look at Figure 7.6 while you read this paragraph. The photo-detector delivers a peak-clipped sine wave (see graph 1) that is amplified in Q1 so that the output of Q1 is approximately a square wave (see graph 2).

The square wave is applied to a Schmitt trigger consisting of Q2 and Q3. The voltage delivered from the collector of Q3 has a fast cut-off time (see graph 3).

Q3 and R10 form a differentiating network that supplies narrow negative pulses to the base of Q4 (see graph 4).

Q4 is normally saturated (turned hard on) but it goes into cut-off every time a negative pulse arrives. The collector of Q4 delivers short positive pulses (see graph 5). Q5 is connected as an emitter follower to enable it to feed sufficient current to the next stage.

Q7 ensures that the working voltage across Q8 is stable.

Q6 charges C4. The charging current is determined by resistors located in the speed control circuit which are connected to the emitter of Q8.

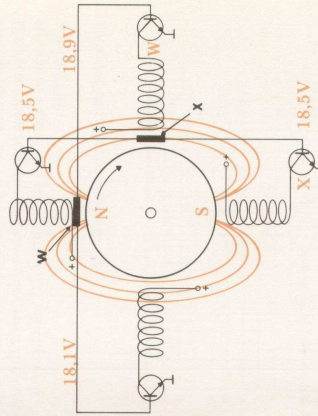
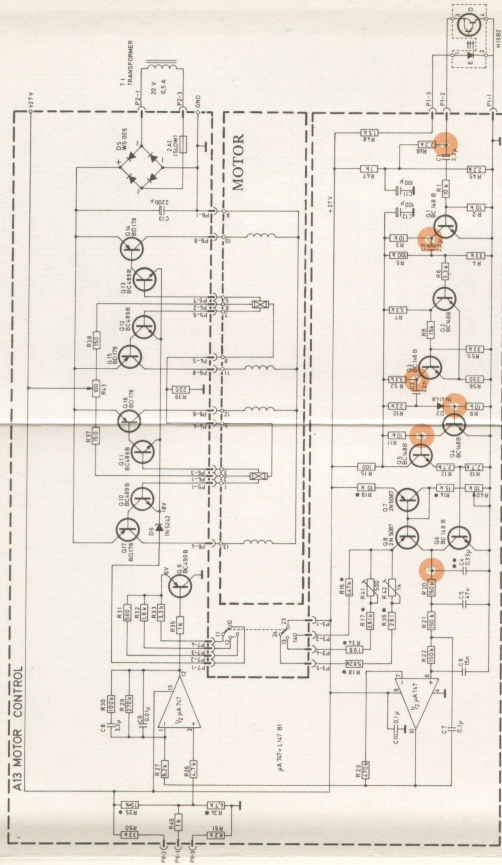
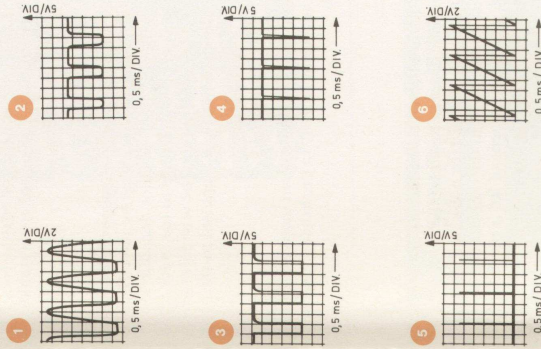

Fig. 7.5 The basic circuit diagram of the motor

The positive pulses (graph 5) on the base of Q6 ensure that Q6 goes into saturation (turns hard on) to discharge C4. This causes the collector of Q6 to deliver sawtooth pulses (see graph 6). These sawtooth pulses are applied to the input, pin 6, of  $\mu A/47$  via R20-R21 and R22. This half of the I.C. circuit is a low pass filter which converts the pulses to d.c. The output, pin 10, is normally about 6 V d.c. This output is connected to the input, pin 1, of the other half of the I.C. circuit. The other input, pin 10, has a stable 6 V d.c. applied to it.



SPEED 7 1/2 ips.



This part of the I.C. circuit is a comparator that compares the two input voltages and amplifies the difference 30 times. The difference voltage is applied to the base of Q9 which controls the current supplied to the motor.

The resistors connected to the emitter of Q9 have the task of ensuring that the same degree of stability is maintained for all speeds.

The charging and discharging of C4 controls the speed of the motor. When the motor speed drops, C4 is charged to a higher value before it is discharged and the peak value of the sawtooth pulses increases (graph 6). This in turn increases the average value of the output voltage of the low pass filter at pin 10. The input, pin 1, to the Comparator receives a higher voltage and the output, pin 12, delivers a low voltage to the emitter follower Q9. Q9 delivers more current to the motor circuit which brings the motor speed back to normal.

#### ADJUSTING THE SPEED

Start adjusting the speed in 15 ips.

R40 can be used to adjust the 15 ips speed. It provides a stable voltage to the base of Q8 and current to C4.

R41 can be used to adjust the 7 1/2 ips speed and R42 can be used to adjust the 3 1/2 ips speed.

Fig. 7.6 Motor control with graphs Modifications on page 31

### 7.2 OSCILLATOR

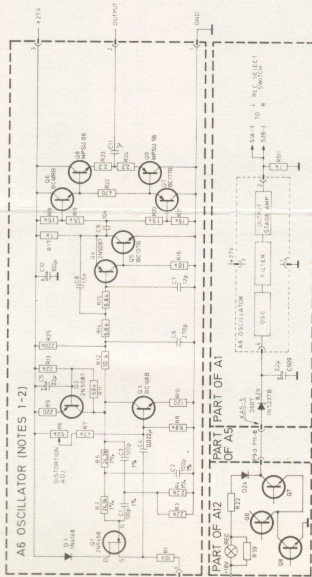

Fig. 7.7 A6. Oscillator

The oscillator is designed as a feedback amplifier. A T-filter consisting of R2-R3-R4 and R5 in connection with C1-C2 and C3 is built in to the feedback loop. The oscillator frequency is determined by the T-filter. At 122 kHz the T-filter provides maximum attenuation and 180° phase shift. The attenuation in the filter is about 25 dB. When the amplification in Q3 is greater than 25 dB the amplifier will start to oscillate. The components in the T-filter have 1% tolerance except R3 which has 5%.

The oscillator starts when the logic board causes point 4 to be grounded. So that the input to Q3 will not load the T-filter Q1 is employed as a source follower (high impedance input).

Q2 forms a part of the collector resistor for Q3 and ensures that the working voltage is stable.

The oscillator generates a peak-clipped sine wave and the amplitude is determined by the H.T. which is stabilized. Since it is not desirable to apply a peak-clipped sine wave to the heads, an active filter Q4-Q5 cleans up the waveform so that only a pure sine wave form is applied to the heads.

The output is a push-pull current amplifier that delivers sufficient current to the heads for erasure and bias.

**NOTE:** R6 is adjusted at the factory for minimum 2nd harmonic distortion and should normally not be touched. If the signal/tape noise ratio deteriorates after components in the oscillator have been changed, a final adjustment of R6 is permissible.

NOTES:

1. UNLESS OTHERWISE SPECIFIED RESISTANCE IN OHMS
2. CAPACITANCE IN P.F.

### 7.3 CHECKING THE RECORD RESPONSE CURVE

Connect a 10 ohm resistor as shown in Figure 7.8. Connect the signal generator to the LINE IN terminals and the high impedance voltmeter in parallel with the 10 ohm resistor.

Short-circuit the base of Q8 (logic board) to the oscillator. Set the machine into the RECORD mode.

Set the LINE INPUT LEVEL controls to 3-4. Turn up the level of the signal generator to get 0 dB on the tape recorder level meter. Adjust the LINE INPUT LEVEL controls to reduce the level 10 dB below 0 dB on the level meter.

Turn the signal generator down a further 20 dB making the tape recorder level 30 dB below 0 dB.

Set the frequency of the signal generator to 400 Hz and use this as the reference frequency. Check that the frequency response curve agrees with the curve shown in Figure 7.9 or Figure 7.10 whichever is appropriate.

Remove the short-circuit on Q8.

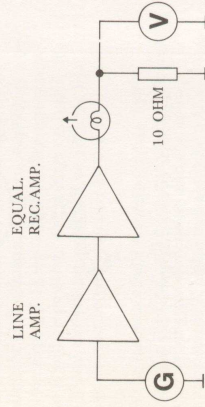

Fig. 7.8 Checking the record curve

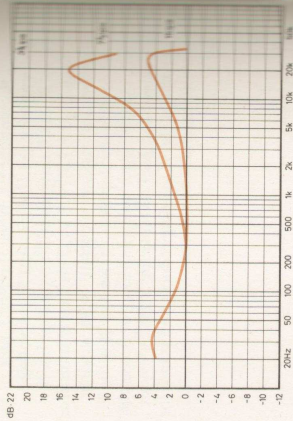

Fig. 7.9 IEC record curve

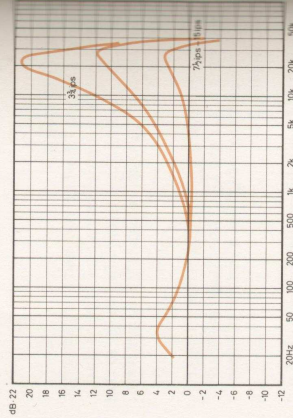

Fig. 7.10 NAB record curve



### 7.3 CHECKING THE RECORD RESPONSE CURVE

Connect a 10 ohm resistor as shown in Figure 7.8. Connect the signal generator to the LINE IN terminals and the high impedance voltmeter in parallel with the 10 ohm resistor.

Short-circuit the base of Q8 (logic board) to stop the oscillator. Set the machine into the RECORD mode.

Set the LINE INPUT LEVEL controls to 3-4. Turn up the level of the signal generator to get 0 dB on the tape recorder level meter. Adjust the LINE INPUT LEVEL controls to reduce the level 10 dB below 0 dB on the level meter.

Turn the signal generator down a further 20 dB making the tape recorder level 30 dB below 0 dB.

Set the frequency of the signal generator to 400 Hz and use this as the reference frequency. Check that the frequency response curve agrees with the curve shown in Figure 7.9 or Figure 7.10 whichever is appropriate.

Remove the short-circuit on Q8.

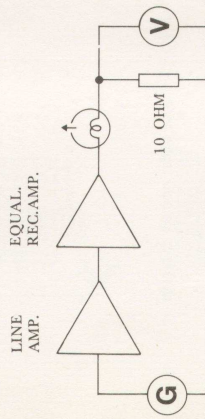

Fig. 7.8 Checking the record curve

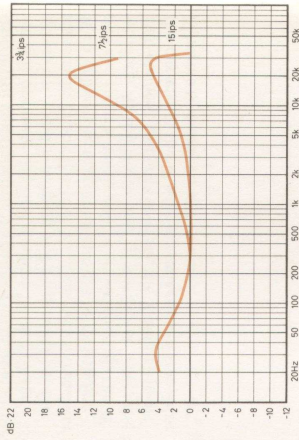

Fig. 7.9 IEC record curve

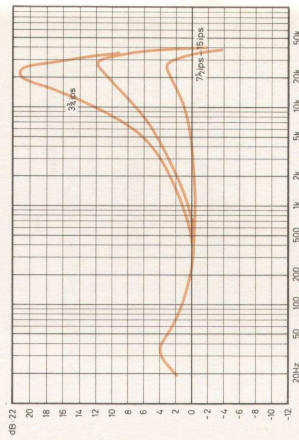

Fig. 7.10 NAB record curve

### 7.4 CHECKING THE PLAYBACK RESPONSE CURVE

Checking with a test tape

Connect a high impedance voltmeter to the LINE OUT terminals. Play back test tape No. 3 for NAB correction, or test tape No. 26 (7 ips) and test tape No. 27 (15 ips) for IEC correction. See the adjustment table on page 18.

Checking with a high impedance voltmeter and signal generator

Connect the voltmeter to the LINE OUT terminals and connect the signal generator as shown in Figure 7.11.

Tune the signal generator to 1000 Hz, and adjust its output to 0.5 V measured across the LINE OUT terminals with the OUTPUT LEVEL controls at max. Check that the frequency response curve agrees with the curve shown in Figure 7.12 or Figure 7.13 as appropriate.

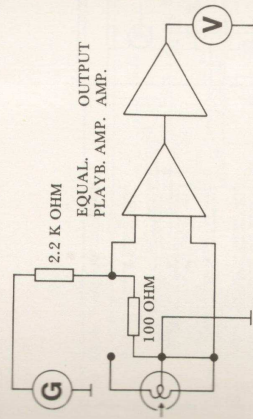

Fig. 7.11 Checking the playback curve

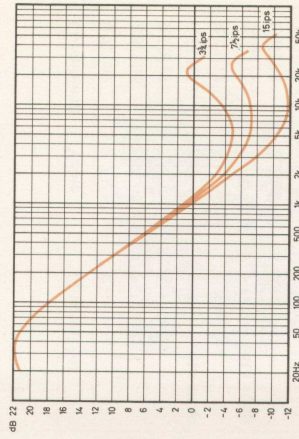

Fig. 7.12 IEC playback curve

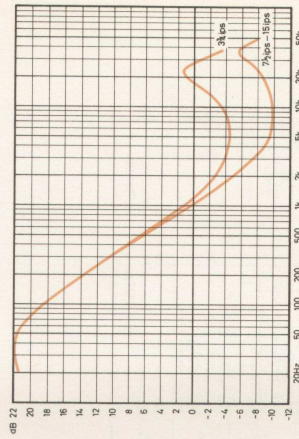

Fig. 7.13 NAB playback curve

5 CHANGING FROM NAB CORRECTION TO IEC CORRECTION, 2-TRACK

record amplifier A7

| Component | Value     | Changed to:        |
|-----------|-----------|--------------------|
| R7/107    | 2,7 k ohm | Removes            |
| R8/108    | 680 ohm   | Removes            |
| R10/110   | 1 k ohm   | 3,3 k ohm          |
| R11/111   | 220 ohm   | Replace with strap |
| R13/113   | 10 k ohm  | 3,3 k ohm          |
| R21/121   | 2,7 k ohm | Replace with strap |
| C4/104    | 0,1 uF    | Removes            |
| C8/108    | 33 uF     | 47 uF              |
| D1/101    | IN4148    | Removes            |

label 1

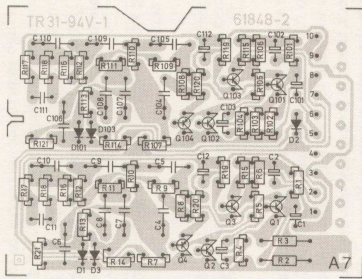

Fig. 7.13 Equal record amp. board

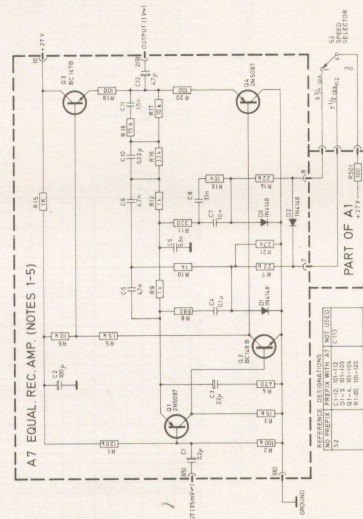

Fig. 7.14 A7, equal record amplifier NAB

Modifications on page 31.

Playback amplifier A11

| Component | Value     | Changed to:    |
|-----------|-----------|----------------|
| R10/110   | 10 k ohm  | 4,7 k ohm      |
| R11/111   | 390 k ohm | 270 k ohm      |
| R12/112   | 15 k ohm  | 5,6 k ohm      |
| R13/113   | 15 k ohm  | 5,6 k ohm      |
| R14/114   | 2,7 M ohm | 1,8 M ohm      |
| R15/115   | 12 k ohm  | 6,8 k ohm      |
| R16/116   | 8,2 k ohm | 2,7 k ohm, new |
| R18/118   |           | 10 k ohm, new  |
| R19/119   |           | 470 pF         |
| C6/106    | 220 pF    | 470 pF         |
| C7/107    | 220 pF    | 470 pF         |
| C8/108    | 470 pF    | 1000 pF        |
| C12/112   | 1000 pF   | 1500 pF        |
| C14/114   |           | 3300 pF, new   |
| D4/104    |           | IN4148, new    |
| D5/105    |           | IN4148, new    |

Table 2

Fig. 7.15 Equal playback amp. board

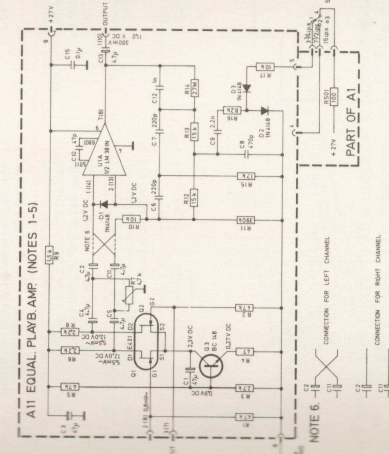
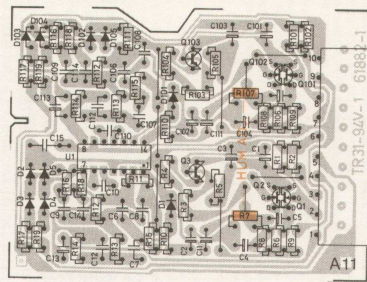

Fig. 7.16 A11, equal playback amplifier NAB

Modifications on page 31.

## 8. ELECTRICAL ADJUSTMENTS

### 8.1 PULL-IN TIME FOR ARMATURES AND STARTING VOLTAGE FOR THE REEL MOTORS

When the machine is in the STOP mode and the PLAY button is pressed the reel motors receive extra voltage at the moment of starting to prevent tape loops forming. (Remember to depress the 10½" REEL button when 10½" reels are in use). The duration of this extra voltage can be adjusted by means of pot. R36 on the logic board. R36 should be adjusted so that the pull-in time is about 250 ms. This delay can be checked on U26-9 with the aid of an oscilloscope.

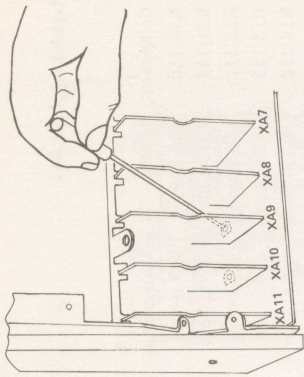

Fig. 8.0 Adjustment of R11\*\*

| Test Adjustment No. or check   | Test No. or check | Measuring instrument at: | Measure at:  | Adjust                              | Correct reading                   | Speed | Dolby* switch | Comments  |
|--------------------------------|-------------------|--------------------------|--------------|-------------------------------------|-----------------------------------|-------|---------------|---|
| 1.1 Hum adj. head, azimuth     | 1                 | a.c. voltmeters          | LINE OUT     | R7 - R107                           | Minimum hum                       | 15"   | OFF           | To be performed without tape. Put a piece of paper between the light source and the photo-transistor. OUTPUT LEVEL to maximum and adjust to minimum hum. Then readjust the Dolby playback level.  |
| 1.2 Playback-head, azimuth     | 2                 | a.c. voltmeters          | LINE OUT     | Azimuth screw                       | Maximum output                    | 7½"   | OFF           | Maximum output or best compromise.  |
| 1.3 Playback N.A.B. or DIN 19H | 3                 | a.c. voltmeters          | LINE OUT     | -                                   | + 4 dB<br>- 2.5 dB                | 7½"   | OFF           | Playback curve, N.A.B. The tape contains the following frequencies: 250 Hz (reference), 500 Hz, 1000 Hz, 2000 Hz (ref.). Playback curve, DIN 19H. The tape contains the following frequencies: 1000 Hz (reference), 18 kHz, 15 kHz, 10 kHz, 4 kHz, 125 Hz, 40 Hz, 1000 Hz (ref.). |
| 1.4 Dolby playback level       | 25                | a.c. voltmeter           | See comments | PLAYBACK R31 - R131                 | 580 mV                            | 7½"   | OFF           | Measure on pin 3, contact XA9 (L) and contact XA10 (R) on the main board. Check that the output (LINE OUT) are within ± 0.5 dB.   |
| 1.5 Speed                      | 11                | Frequency counter        | LINE OUT     | R40 - 15"<br>R41 - 7½"<br>R42 - 3%" | ± 0.3%<br>997 - 1003 Hz<br>in 7½" | All   | OFF           | Test-tape No. 11 are recorded at 1000 Hz in 7½". Start in 15". Adjust R40 to correct speed. Then adjust R41 in 7½" and R42 in 3%. R40/R41/R42 are on the motor control board.   |
| 1.6 Bias pre-adjustment        | -                 | a.c. voltmeter           | See comments | Bias adj. R44 - R144                | Approx. 22 V                      | 7½"   | OFF           | To be performed without tape. Measure across the bias head on pin 2 (L) and pin 3 (R) on contact P11 on the main board.   |

Adjustment table 1

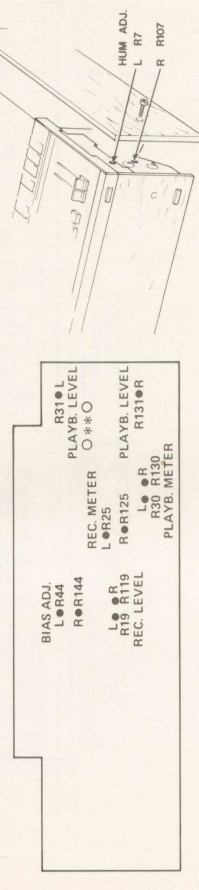

Fig. 8.1 Location of adjustment points

\* The word Dolby is a Trade Mark of Dolby Laboratories Inc.

\*\* On later machines a hole will be drilled in the main board A1 to permit R11 to be adjusted (see Figure 8.1).

| Test Adjustment No. or check        | Measuring instrument at: | Measure at:   | Dolby* switch | SOURCE/TAPE buttons | Set the deck to   | Procedure   |
|-------------------------------------|--------------------------|---------------|---------------|---------------------|-------------------|---|
| 2.1 Bias head horizontal adjustment | a.c. voltmeters          | LINE OUT      | OFF           | TAPE                | RECORD 7½"        | Connect an audio-generator to LINE IN. Set the generator to 1000 Hz and adjust with the LINE INPUT LEVEL to approx. 0.5 V on the voltmeters. Turn the 2 mm Allen screw clockwise and the head moves to the left. Then turn the screw counter-clockwise to maximum reading on the voltmeters. Move the first maximum when the head moves from the left to the right side.  |
| 2.2 Azimuth, record head            | a.c. voltmeters          | LINE OUT      | OFF           | TAPE                | RECORD 33"        | Connect an audio-generator to LINE IN. Start stereo recording, 18,000 Hz. In 3½" approach - 20 dB below normal recording level, 0 dB. Then turn the azimuth screw to maximum or best compromise on the LINE OUT.  |
| 2.3 Record/playback curves          | a.c. voltmeters          | LINE OUT      | OFF/NORM      | TAPE                | RECORD all speeds | Connect an audio-generator to LINE IN. Start recording in 3½" of a 1000 Hz signal 30 dB above the level of the reference level. Then readjust the output level at the same level and check that the output is within ± 2 dB. If the output is too high, increase bias current with R44 (L) and R144 (R). If the output is too low, alter the signal frequency to 1000 Hz and adjust for maximum output with R44 (L) and R144 (R). Then establish a reference level, and re-check the output at 18,000 Hz. When the reference at 18,000 Hz has been met, check that the output level not deviate more than ± 2 dB from the following frequencies:<br>15" ± 2 dB 30-25,000 Hz *<br>7½" ± 2 dB 30-22,000 Hz<br>3½" ± 2 dB 40-18,000 Hz<br>When you switch the Dolby knob from OFF to NORM, check that the output level not deviate more than ± 3 dB. |
| 2.4 Dolby SOURCE level              | a.c. voltmeter           | See procedure | OFF           | SOURCE              | RECORD 7½"        | Connect an audio-generator, 1000 Hz, to LINE IN. Set the deck to stereo record in SOURCE. Adjust with the LINE INPUT LEVEL to 580 mV on pin 2 on Dolby encoder XA3 and XA4. Then check for 580 mV ± 0.5 dB at pin 3 on Dolby decoder XA9 and XA10. Re-adjust R11 on Dolby decoder XA9 and XA10 if necessary. If R11 is outside the tolerance, re-adjust the Dolby playback level. See Fig. 8.0.   |
| 2.5 SOURCE/TAPE                     | a.c. voltmeters          |               | OFF           | SOURCE/TAPE         | RECORD 7½"        | Connect an audio-generator, 1000 Hz, to LINE IN. Set the deck to SOURCE. Adjust with the LINE INPUT LEVEL to 580 mV on pin 3 on Dolby decoder XA9 and XA10. Set the deck to TAPE. Then adjust RECORD LEVEL R19 (L) and R119 (R) so that the level reading is 1 dB higher when using Maxell UD35 tape (or equivalent), if not adjust to same reading on Dolby decoder.   |
| 2.6 Record METER adjustment         | a.c. voltmeter           | -             | OFF           | SOURCE              | RECORD 7½"        | Audio-generator 1000 Hz to LINE IN. Set the deck to SOURCE. Adjust with the LINE INPUT LEVEL to 1.15 V at pin 2 on the Dolby decoder XA3 and XA4. Then adjust the record meters to 0 dB with R25 (L) and R125 (R).  |
| 2.7 Playback METER adjustment       | a.c. voltmeter           |               | OFF           | SOURCE              | PLAY 7½"          | Audio-generator 1000 Hz to LINE IN. Adjust with the LINE INPUT LEVELS to the same output as in adjustment 2.6. Then adjust the playback METERS to 0 dB with R30 (L) and R130 (R).   |
| 2.8 Distortion                      | Distortion meter         | LINE OUT      | OFF           | TAPE                | RECORD 7½"        | Connect an audio-generator (or distortion meter generator) 1000 Hz, to the LINE IN. Set the deck to TAPE. Then adjust the distortion on the LINE OUT. Maximum distortion is 2%.   |
| 2.9 Wow and flutter                 | Wow and flutter meter    | LINE OUT      | OFF           | TAPE                | RECORD 7½"        | Connect the wow-and-flutter-meter generator to the LINE IN. Read on the LINE OUT and in all speeds. If necessary, adjust R43 (on the motor control board) to minimum wow and flutter in 3½".<br>Wow and flutter max: 15" 7½" 3%"<br>Peak, DIN 45511 0.07% 0.09% 0.15%<br>Weighted R.M.S. 0.04% 0.06% 0.11%  |

Adjustment table 2

\* Use tape with 15 μ magnetic coating when adjusting the record-playback curve in 15 ips.  
If tape with 10 μ magnetic coating are used, the higher frequencies in the record/playback curve will raise approx. 2 dB.

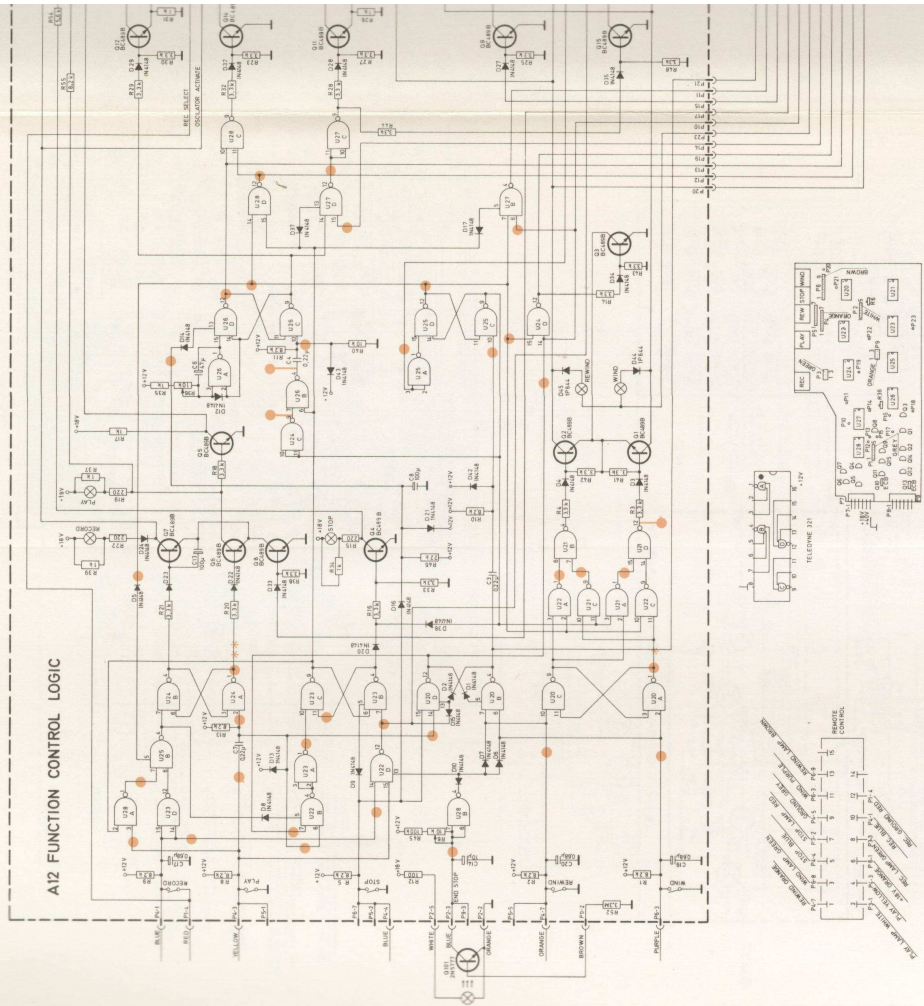
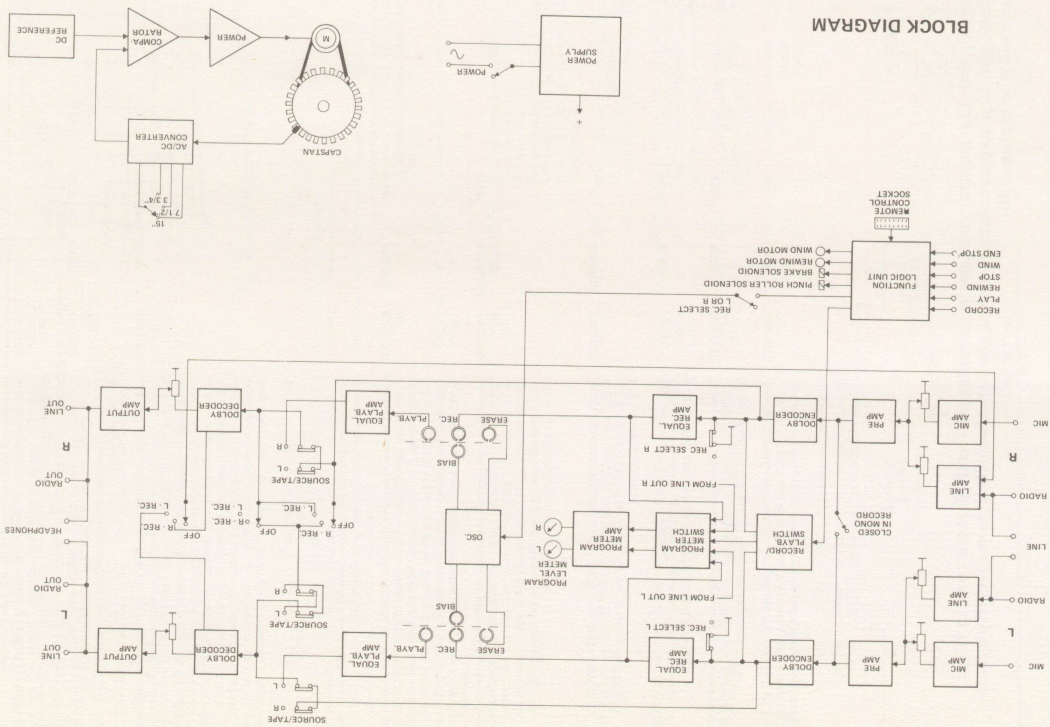

Fig. 8.2 A12 and A14, function control logic a

Red dots indicate high level in STOP.  
 \* STOP from PLAY  
 \*\* STOP from WIND



BLOCK DIAGRAM

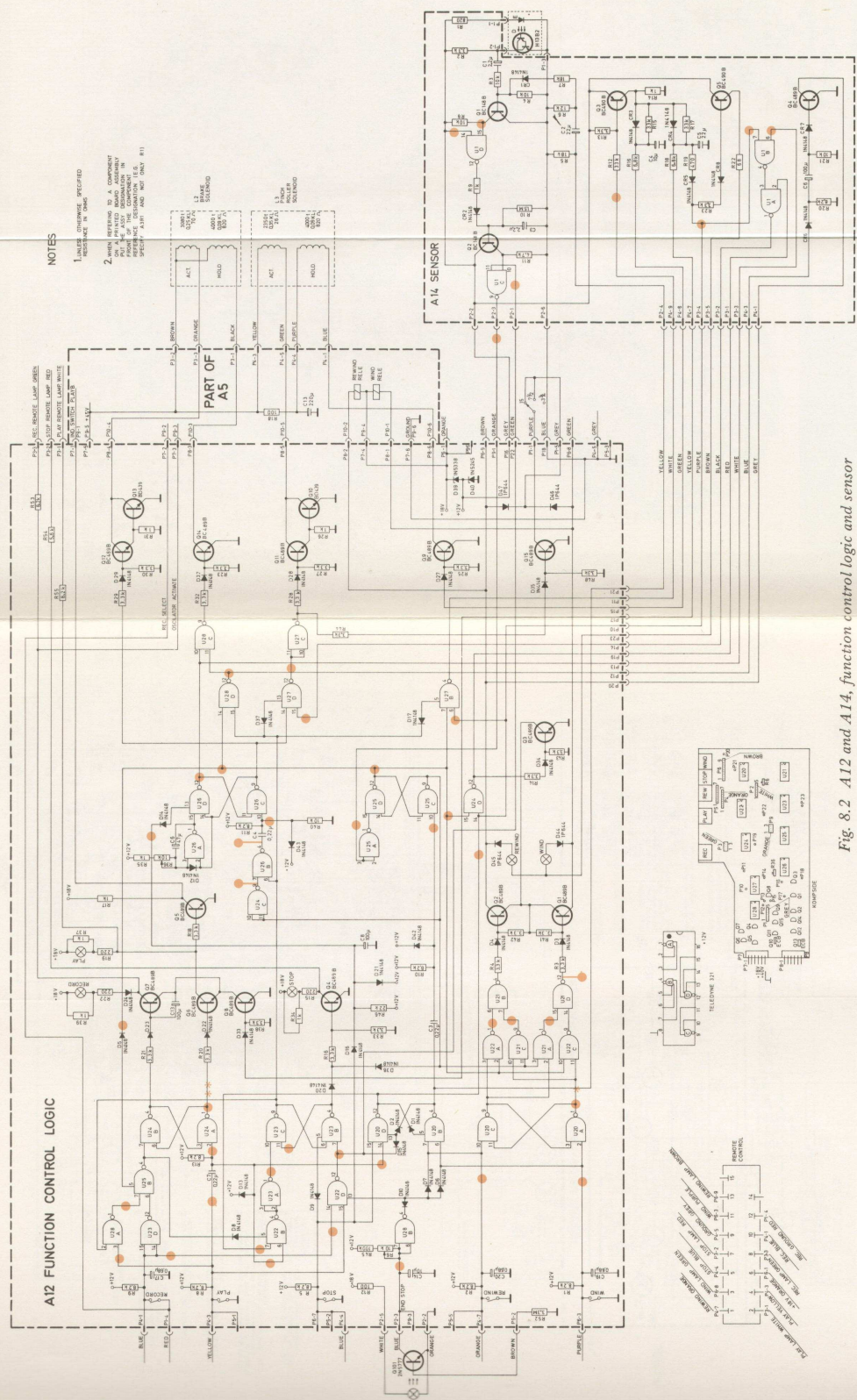
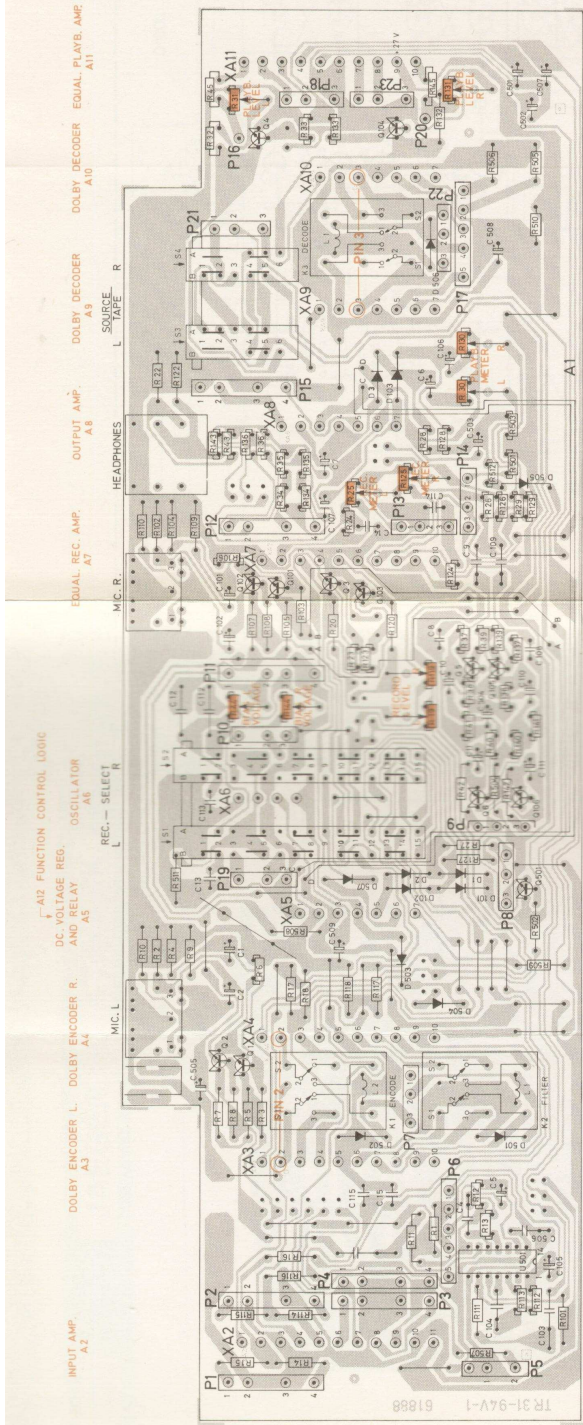
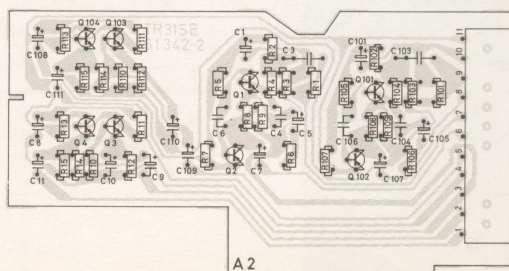
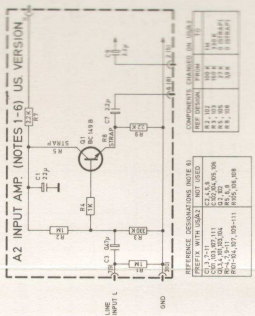
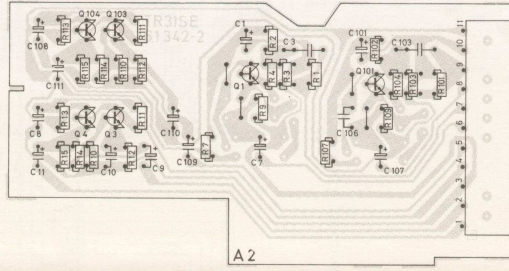
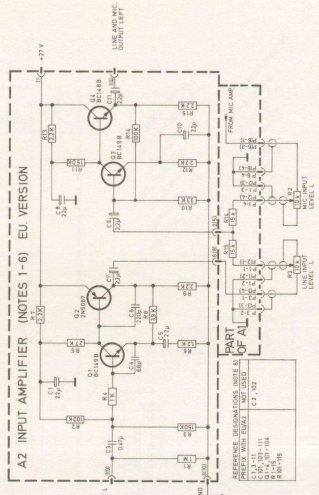

Fig. 8.2 A12 and A14, function control logic and sensor



A1 MAIN BOARD



- NOTES
1. UNLESS OTHERWISE SPECIFIED RESISTANCE IS IN OHMS
  2. WHEN REFERRING TO A COMPONENT ON A BOARD, REFER TO THE BOARD IDENTIFICATION AND POINT OF THE COMPONENT AS APPLICABLE TO THE BOARD TYPE AND NOT ONLY TO THE BOARD IDENTIFICATION
  3. ONLY THE L-COMMON OF THE ASSEMBLY IS SHOWN
  4. PLUS TERMINALS FOR THE R-COMMON ARE SHOWN IN RED. PLUS TERMINALS FOR THE L-COMMON ARE SHOWN IN BLUE
  5. L-COMMON HAS 100 OHM RESISTANCE. R-COMMON HAS 100 OHM RESISTANCE. PLUS TERMINALS ARE SHOWN IN RED. PLUS TERMINALS FOR THE L-COMMON ARE SHOWN IN BLUE. PLUS TERMINALS FOR THE R-COMMON ARE SHOWN IN RED
  6. BOARD IDENTIFICATION (SEE NOTE 2) IS SHOWN AT THE BOTTOM OF THE BOARD. THE BOARD IDENTIFICATION IS SHOWN IN RED

ALL THE BOARDS ARE SEEN FROM SOLDER SIDE

A2 INPUT AMP. BOARD, EUROPEAN VERSION

A2 INPUT AMP. BOARD, US VERSION

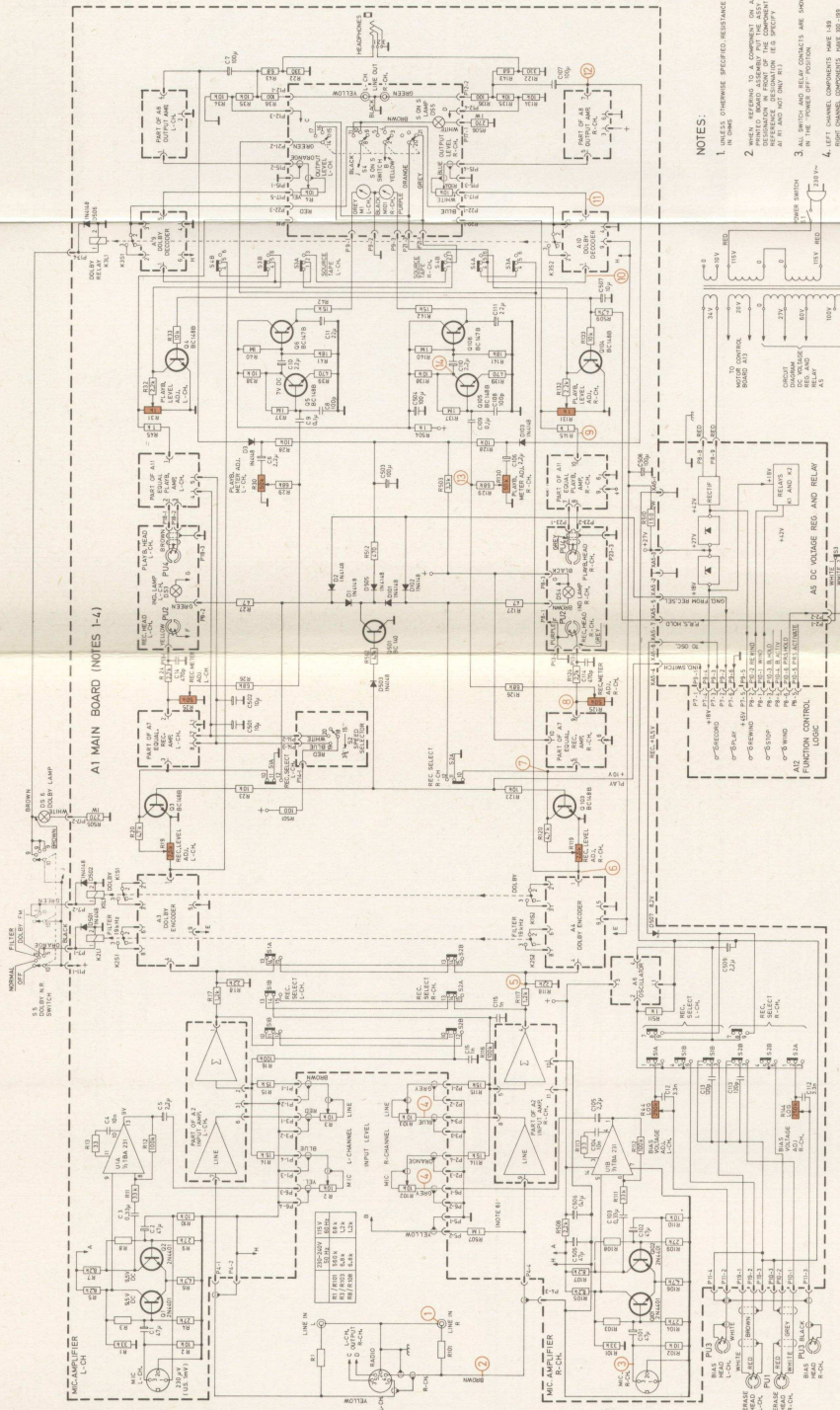

**A1 MAIN BOARD (NOTES 1-4)**

- NOTES:**
1. UNLESS OTHERWISE SPECIFIED, RESISTANCE IS OHMS.
  2. REFERENCE TO A COMPONENT ON A BOARD IS MADE BY THE BOARD NUMBER, COMPONENT REFERENCE DESIGNATION, U.S. COMPONENT NUMBER, AND BOARD AND COMPONENT POSITION AT THE POINT OF LOCATION.
  3. ALL SWITCH AND RELAY CONTACTS ARE SHOWN IN THE "POWER OFF" POSITION.
  4. LEFT CHANNEL COMPONENTS HAVE L-100 AND RIGHT CHANNEL COMPONENTS HAVE R-100 AND COMPONENTS COMMON FOR BOTH CHANNELS HAVE 100 NUMBERS.

**TABLE 1. SENSITIVITY OF AMPLIFIERS**

| TYPE | SENSITIVITY AT 1000 Hz | SENSITIVITY AT 100 Hz |
|------|------------------------|-----------------------|
| 1    | 100 mV                 | 100 mV                |
| 2    | 100 mV                 | 100 mV                |
| 3    | 100 mV                 | 100 mV                |
| 4    | 100 mV                 | 100 mV                |
| 5    | 100 mV                 | 100 mV                |
| 6    | 100 mV                 | 100 mV                |
| 7    | 100 mV                 | 100 mV                |
| 8    | 100 mV                 | 100 mV                |
| 9    | 100 mV                 | 100 mV                |
| 10   | 100 mV                 | 100 mV                |
| 11   | 100 mV                 | 100 mV                |
| 12   | 100 mV                 | 100 mV                |
| 13   | 100 mV                 | 100 mV                |
| 14   | 100 mV                 | 100 mV                |
| 15   | 100 mV                 | 100 mV                |
| 16   | 100 mV                 | 100 mV                |
| 17   | 100 mV                 | 100 mV                |
| 18   | 100 mV                 | 100 mV                |
| 19   | 100 mV                 | 100 mV                |
| 20   | 100 mV                 | 100 mV                |
| 21   | 100 mV                 | 100 mV                |
| 22   | 100 mV                 | 100 mV                |
| 23   | 100 mV                 | 100 mV                |
| 24   | 100 mV                 | 100 mV                |
| 25   | 100 mV                 | 100 mV                |
| 26   | 100 mV                 | 100 mV                |
| 27   | 100 mV                 | 100 mV                |
| 28   | 100 mV                 | 100 mV                |
| 29   | 100 mV                 | 100 mV                |
| 30   | 100 mV                 | 100 mV                |
| 31   | 100 mV                 | 100 mV                |
| 32   | 100 mV                 | 100 mV                |
| 33   | 100 mV                 | 100 mV                |
| 34   | 100 mV                 | 100 mV                |
| 35   | 100 mV                 | 100 mV                |
| 36   | 100 mV                 | 100 mV                |
| 37   | 100 mV                 | 100 mV                |
| 38   | 100 mV                 | 100 mV                |
| 39   | 100 mV                 | 100 mV                |
| 40   | 100 mV                 | 100 mV                |
| 41   | 100 mV                 | 100 mV                |
| 42   | 100 mV                 | 100 mV                |
| 43   | 100 mV                 | 100 mV                |
| 44   | 100 mV                 | 100 mV                |
| 45   | 100 mV                 | 100 mV                |
| 46   | 100 mV                 | 100 mV                |
| 47   | 100 mV                 | 100 mV                |
| 48   | 100 mV                 | 100 mV                |
| 49   | 100 mV                 | 100 mV                |
| 50   | 100 mV                 | 100 mV                |

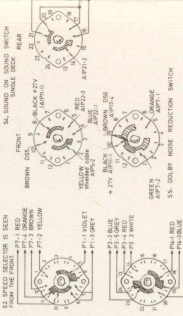
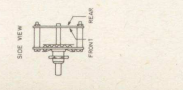

ALL THE SWITCHES ARE SEEN FROM SOLDER SIDE (NOTE 7 AND 3)

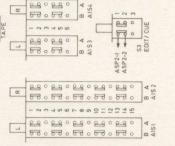

**REFERENCE DESIGNATIONS**

| REF. DES. | QTY. | U.S. PART NO. | MANUFACTURER |
|-----------|------|---------------|--------------|
| 100-1     | 1    | 100-1         | 100-1        |
| 100-2     | 1    | 100-2         | 100-2        |
| 100-3     | 1    | 100-3         | 100-3        |
| 100-4     | 1    | 100-4         | 100-4        |
| 100-5     | 1    | 100-5         | 100-5        |
| 100-6     | 1    | 100-6         | 100-6        |
| 100-7     | 1    | 100-7         | 100-7        |
| 100-8     | 1    | 100-8         | 100-8        |
| 100-9     | 1    | 100-9         | 100-9        |
| 100-10    | 1    | 100-10        | 100-10       |
| 100-11    | 1    | 100-11        | 100-11       |
| 100-12    | 1    | 100-12        | 100-12       |
| 100-13    | 1    | 100-13        | 100-13       |
| 100-14    | 1    | 100-14        | 100-14       |
| 100-15    | 1    | 100-15        | 100-15       |
| 100-16    | 1    | 100-16        | 100-16       |
| 100-17    | 1    | 100-17        | 100-17       |
| 100-18    | 1    | 100-18        | 100-18       |
| 100-19    | 1    | 100-19        | 100-19       |
| 100-20    | 1    | 100-20        | 100-20       |
| 100-21    | 1    | 100-21        | 100-21       |
| 100-22    | 1    | 100-22        | 100-22       |
| 100-23    | 1    | 100-23        | 100-23       |
| 100-24    | 1    | 100-24        | 100-24       |
| 100-25    | 1    | 100-25        | 100-25       |
| 100-26    | 1    | 100-26        | 100-26       |
| 100-27    | 1    | 100-27        | 100-27       |
| 100-28    | 1    | 100-28        | 100-28       |
| 100-29    | 1    | 100-29        | 100-29       |
| 100-30    | 1    | 100-30        | 100-30       |
| 100-31    | 1    | 100-31        | 100-31       |
| 100-32    | 1    | 100-32        | 100-32       |
| 100-33    | 1    | 100-33        | 100-33       |
| 100-34    | 1    | 100-34        | 100-34       |
| 100-35    | 1    | 100-35        | 100-35       |
| 100-36    | 1    | 100-36        | 100-36       |
| 100-37    | 1    | 100-37        | 100-37       |
| 100-38    | 1    | 100-38        | 100-38       |
| 100-39    | 1    | 100-39        | 100-39       |
| 100-40    | 1    | 100-40        | 100-40       |
| 100-41    | 1    | 100-41        | 100-41       |
| 100-42    | 1    | 100-42        | 100-42       |
| 100-43    | 1    | 100-43        | 100-43       |
| 100-44    | 1    | 100-44        | 100-44       |
| 100-45    | 1    | 100-45        | 100-45       |
| 100-46    | 1    | 100-46        | 100-46       |
| 100-47    | 1    | 100-47        | 100-47       |
| 100-48    | 1    | 100-48        | 100-48       |
| 100-49    | 1    | 100-49        | 100-49       |
| 100-50    | 1    | 100-50        | 100-50       |

DS ARE SEEN SIDE

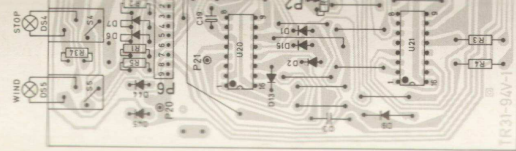

**NOTES**

1. VALUES OTHERWISE SPECIFIED  
RESISTANCE IN OHMS
2. DIMENSIONS REFERRED TO DIMENSIONS  
WHICH ARE SHOWN IN THE  
POINT OF THE COMPONENT IN  
SPECIFY PART AND NOT ONLY P1

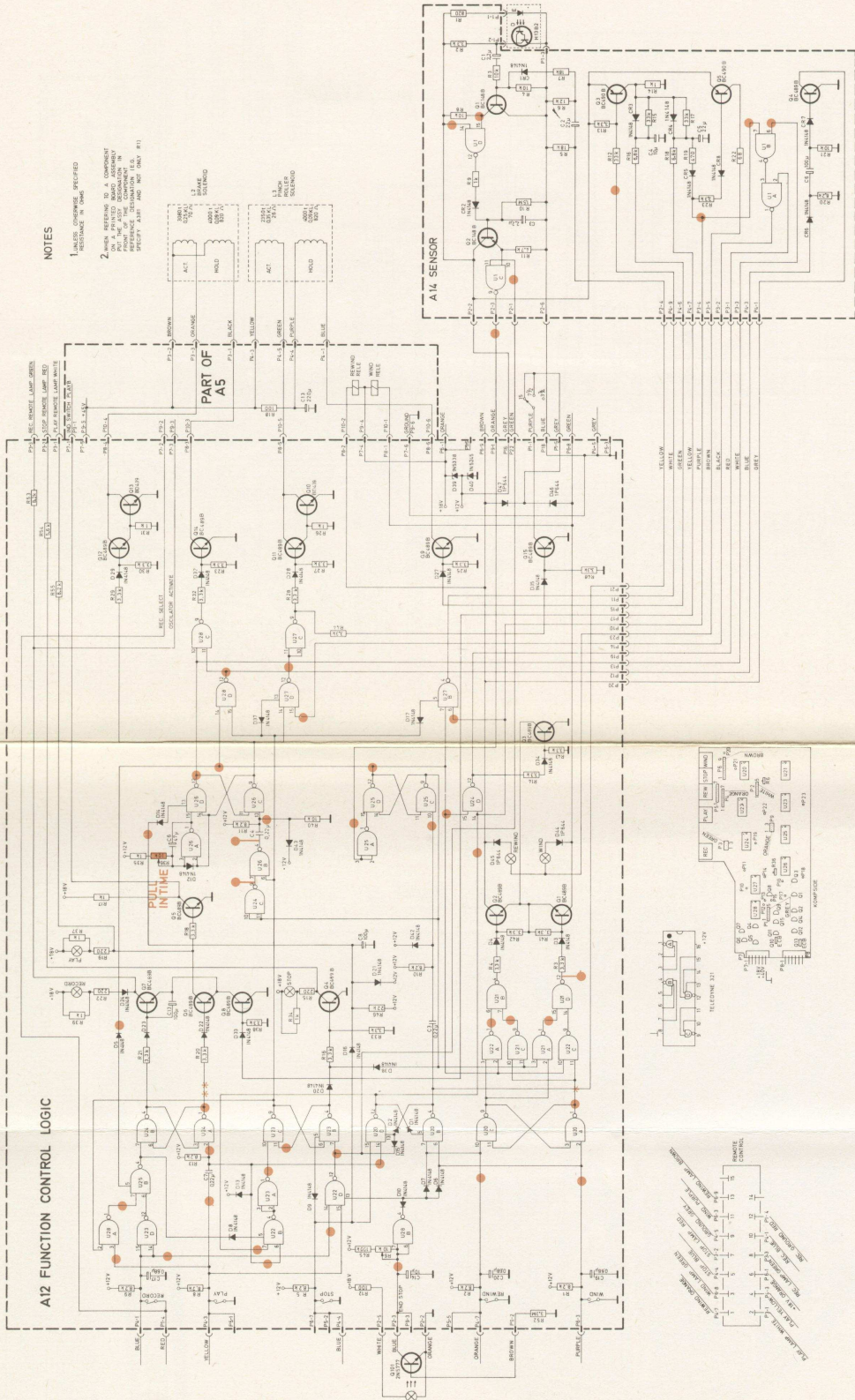

**A12 FUNCTION CONTROL LOGIC**

Red dots indicate high level in STOP.  
 \* STOP from PLAY  
 \*\* STOP from WIND

**A14 SENSOR**



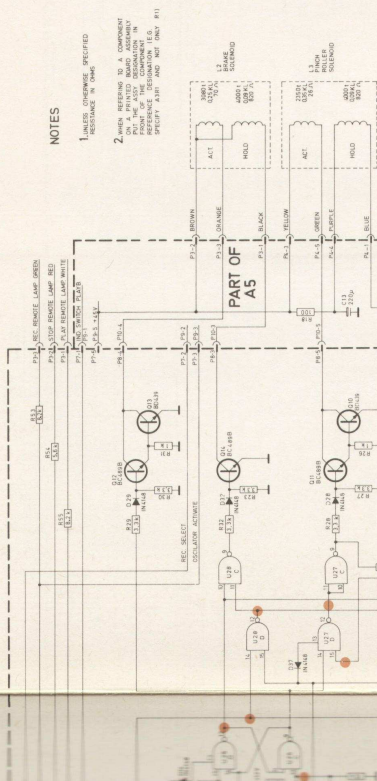

**NOTES**

1. RESISTOR NOMINAL VALUE SPECIFIED IN PARTS LIST.
2. WIRE PART NUMBER AND POINT OF ATTACHMENT SPECIFIED IN PARTS LIST.

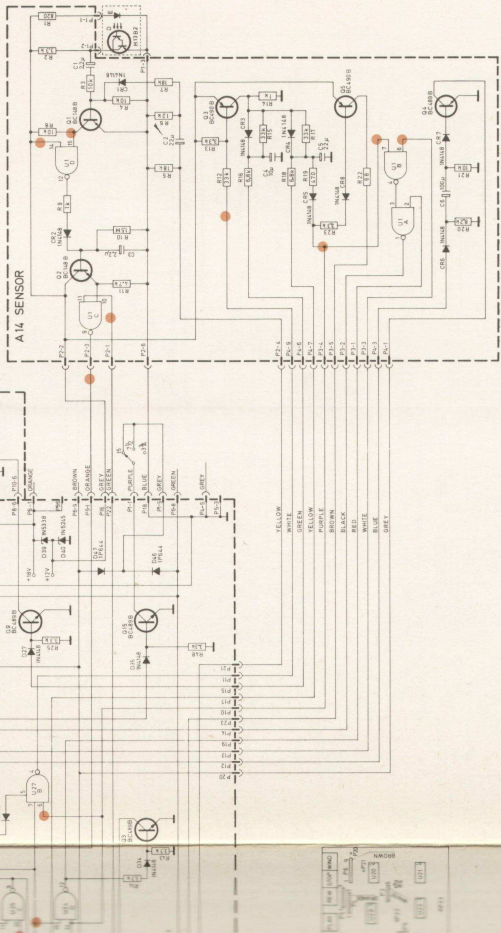

**A14 SENSOR**

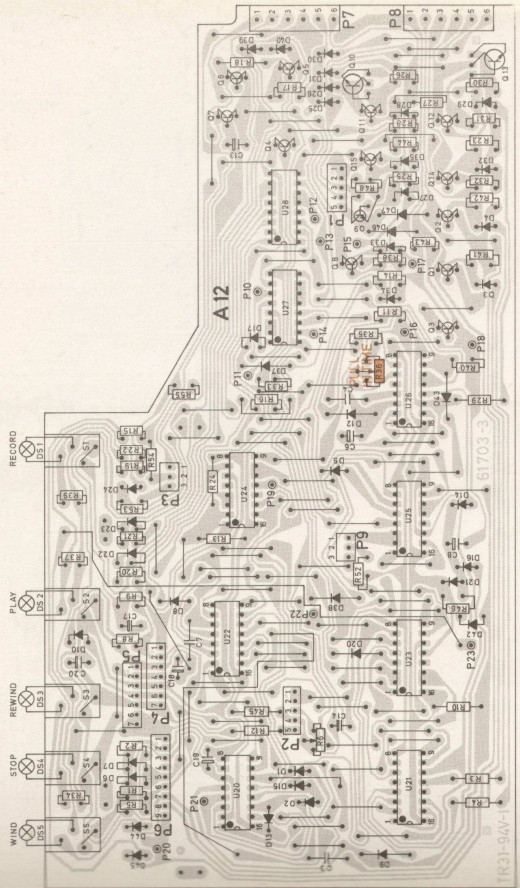

**A12 LOGIC BOARD**

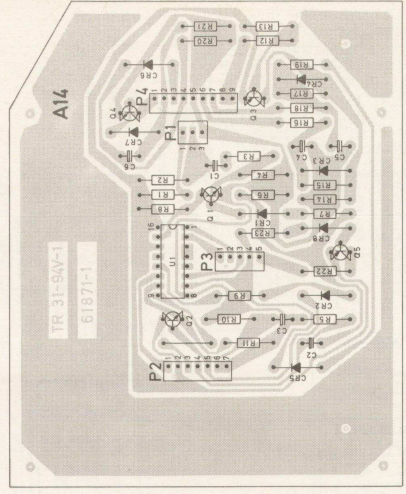

**A14 SENSOR BOARD**

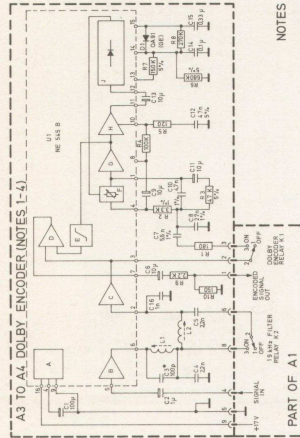
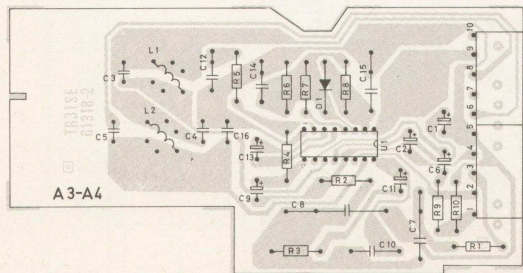

- NOTES:**
1. DIMENSIONS SPECIFIED IN THIS DRAWING ARE IN INCHES.
  2. WHEN REFERRING TO A COMPONENT IN THIS DRAWING, THE REFERENCE DESIGNATION IN THIS DRAWING IS TO BE USED.
  3. ALL SWITCHES AND RELAYS IN THE "POWER OFF" POSITION.
  4. A1 IS USED FOR THE L-CIRCUIT, AND A2 IS USED FOR THE R-CIRCUIT.

REFERENCE DESIGNATIONS

|            |               |
|------------|---------------|
| RESISTOR   | R1-R10        |
| CAPACITOR  | C1-C10        |
| TRANSISTOR | TR15E, TR1P-2 |
| RELAY      | A1, A2        |

**A3-A4 DOLBY ENCODER**

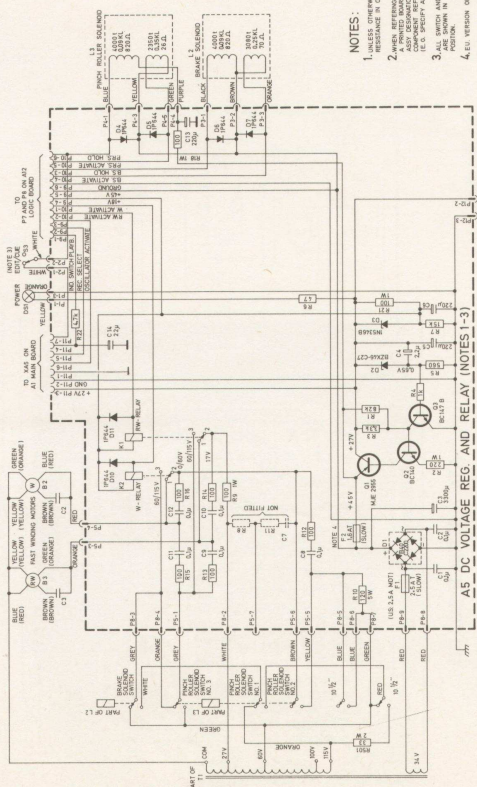

- NOTES:**
1. DIMENSIONS SPECIFIED IN THIS DRAWING ARE IN INCHES.
  2. WHEN REFERRING TO A COMPONENT IN THIS DRAWING, THE REFERENCE DESIGNATION IN THIS DRAWING IS TO BE USED.
  3. ALL SWITCHES AND RELAYS IN THE "POWER OFF" POSITION.

REFERENCE DESIGNATIONS

|            |               |
|------------|---------------|
| RESISTOR   | R1-R10        |
| CAPACITOR  | C1-C10        |
| TRANSISTOR | TR15E, TR1P-2 |
| RELAY      | A1, A2        |

REFERENCE DESIGNATIONS

|            |               |
|------------|---------------|
| RESISTOR   | R1-R10        |
| CAPACITOR  | C1-C10        |
| TRANSISTOR | TR15E, TR1P-2 |
| RELAY      | A1, A2        |

**A5 DC VOLTAGE REG. AND RELAY CIRCUIT**

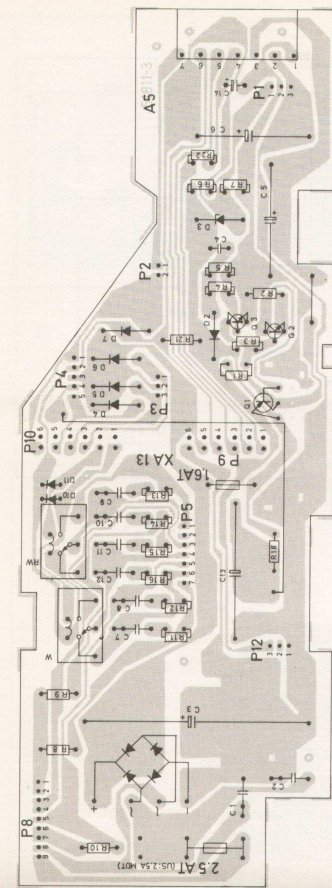

**A5 D.C. VOLTAGE REG. AND RELAY BOARD**

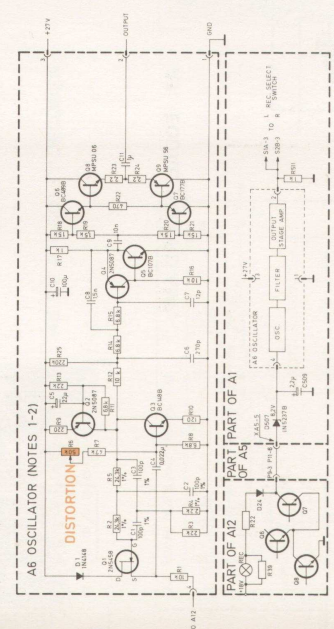

- NOTES:**
1. DIMENSIONS SPECIFIED IN THIS DRAWING ARE IN INCHES.
  2. WHEN REFERRING TO A COMPONENT IN THIS DRAWING, THE REFERENCE DESIGNATION IN THIS DRAWING IS TO BE USED.

REFERENCE DESIGNATIONS

|            |               |
|------------|---------------|
| RESISTOR   | R1-R10        |
| CAPACITOR  | C1-C10        |
| TRANSISTOR | TR15E, TR1P-2 |
| RELAY      | A1, A2        |

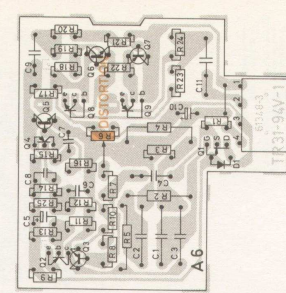

**A6 OSCILLATOR**

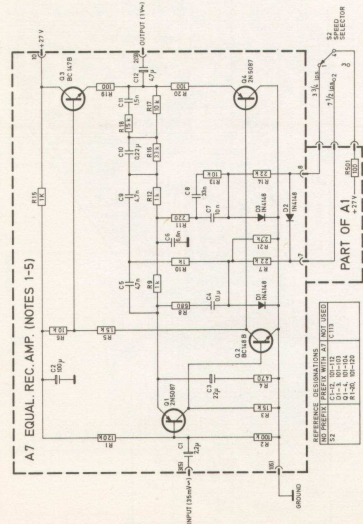

**NOTES:**

1. UNLESS OTHERWISE SPECIFIED RESISTANCE IN OHMS.
2. WHEN REFERRING TO A COMPONENT ON A PRINTED BOARD ASSEMBLY FOR THE ASSEMBLY IDENTIFICATION, SPECIFY THE BOARD IDENTIFICATION AND PART NUMBER.
3. ALL DIMENSIONS ARE IN MILLIMETERS UNLESS OTHERWISE SPECIFIED.
4. A4 IS USED FOR THE R-CHANNEL.
5. DIMENSIONS ARE IN MILLIMETERS UNLESS OTHERWISE SPECIFIED.

**A7 EQUAL. RECORD AMP.**

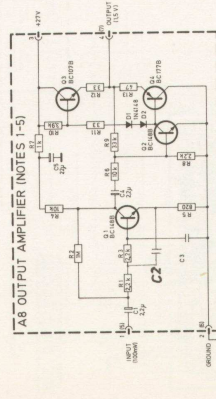

- C2 3500pF
- C3 1500pF

**NOTES:**

1. UNLESS OTHERWISE SPECIFIED RESISTANCE IN OHMS.
2. WHEN REFERRING TO A COMPONENT ON A PRINTED BOARD ASSEMBLY FOR THE ASSEMBLY IDENTIFICATION, SPECIFY THE BOARD IDENTIFICATION AND PART NUMBER.
3. ALL DIMENSIONS ARE IN MILLIMETERS UNLESS OTHERWISE SPECIFIED.
4. PLUS TERMINAL NOTED FOR THE R-CHANNEL.
5. DIMENSIONS ARE IN MILLIMETERS UNLESS OTHERWISE SPECIFIED.

**A8 OUTPUT AMP. BOARD**

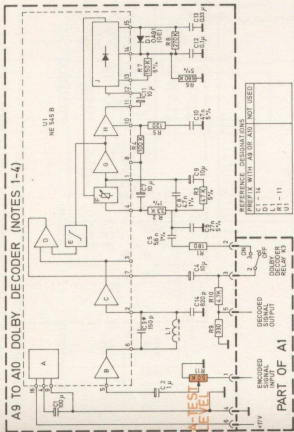

**NOTES:**

1. UNLESS OTHERWISE SPECIFIED RESISTANCE IN OHMS.
2. WHEN REFERRING TO A COMPONENT ON A PRINTED BOARD ASSEMBLY FOR THE ASSEMBLY IDENTIFICATION, SPECIFY THE BOARD IDENTIFICATION AND PART NUMBER.
3. ALL DIMENSIONS ARE IN MILLIMETERS UNLESS OTHERWISE SPECIFIED.
4. A4 IS USED FOR THE LEFT CHANNEL.

**A9 TO A10 DOLBY DECODER**

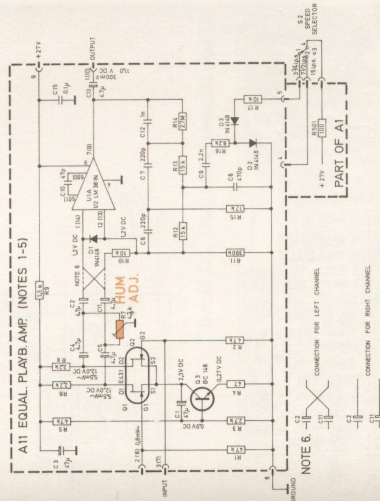

**NOTES:**

1. UNLESS OTHERWISE SPECIFIED RESISTANCE IN OHMS.
2. WHEN REFERRING TO A COMPONENT ON A PRINTED BOARD ASSEMBLY FOR THE ASSEMBLY IDENTIFICATION, SPECIFY THE BOARD IDENTIFICATION AND PART NUMBER.
3. ALL DIMENSIONS ARE IN MILLIMETERS UNLESS OTHERWISE SPECIFIED.
4. PLUS TERMINAL NOTED FOR THE R-CHANNEL.
5. DIMENSIONS ARE IN MILLIMETERS UNLESS OTHERWISE SPECIFIED.

**A11 EQUAL. PLAYB. AMP.**

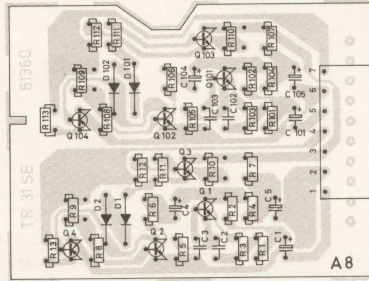
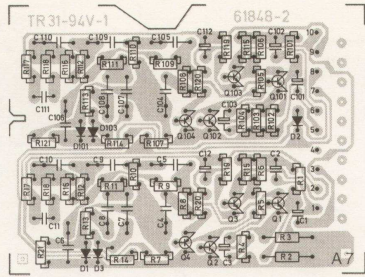
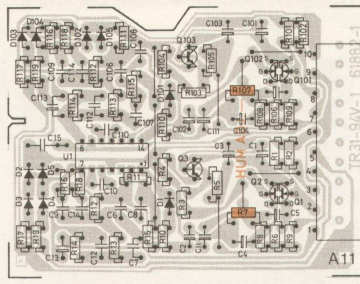
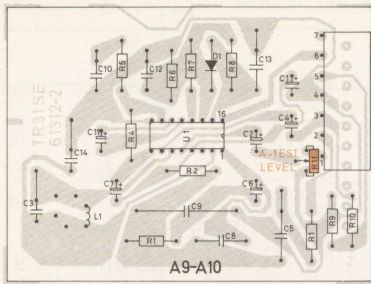

**Modifications introduced on the motor control board from Serial No. 2371350:**

| Component | Value     | Changed to:        |
|-----------|-----------|--------------------|
| R39       | 220 ohm   | 150 ohm, 2W        |
| R37/R38   | 150 ohm   | 330 ohm            |
| R32       | 1.8 k ohm | 1.2 k ohm          |
| R33       | 3.3 k ohm | 2.2 k ohm          |
| D6        | IN5242    | Replace with strap |

Table 1 A12.

**Modifications introduced on the A11 EQUAL PLAYB. AMP. from approx. No. 2371550**

| Component   | Value     | Changed to: |
|-------------|-----------|-------------|
| C8/C108*    | 470 pF    | 330 pF      |
| R16/R116**  | 8.2 k ohm | 6.8 k ohm   |
| R1/R101***  | 47 k ohm  | 33 k ohm    |
| R2/R102***  | 47 k ohm  | 33 k ohm    |
| R16/R116*** | 8.2 k ohm | 4.7 k ohm   |

Table 3. A11

\*\*\* Install on the main board a capacitor, 0.068 μF between pin 2 and 5 on contact XA3 and XA4.

\* All decks  
\*\* NAB four track only  
\*\*\* NAB two track only

**Modifications introduced on the motor control board from Serial No. 2371350:**

| Component | Value   | Changed to: |
|-----------|---------|-------------|
| C4/C104   | 0.1 μF  | 0.047 μF    |
| R8/R108   | 680 ohm | 1.5 k ohm   |

Table 2. All decks: A7

**Modifications introduced on the A7 EQUAL REC. AMP. from approx. No. 2371550**

| Component | Value   | Changed to: |
|-----------|---------|-------------|
| C4/C104   | 0.1 μF  | 0.047 μF    |
| R8/R108   | 680 ohm | 1.5 k ohm   |

Table 2. All decks: A7

**Modifications introduced on the motor control board from Serial No. 2371350:**

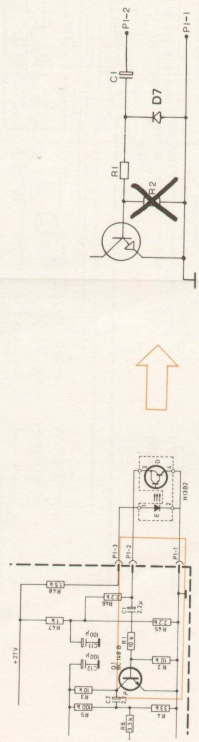

Install D7, 1N4148 between R1 and C1 to ground. R2 removes.

**USA only**

On USA models, resistors R3-103 and R8-108 mounted on the main board A1 have been changed to 1.2 k ohm. This is because the sensitivity of the mic. input has been changed.

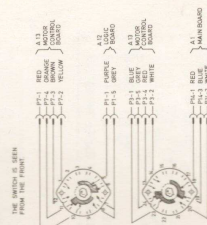
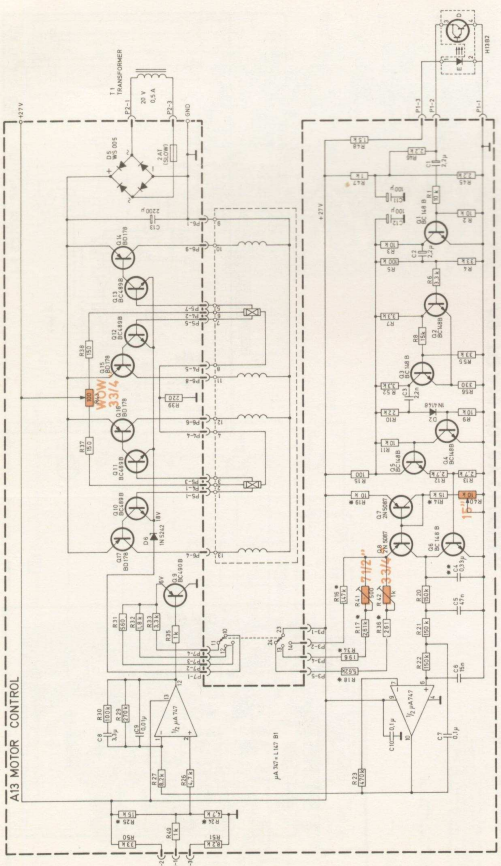

- NOTES**
1. ALL RESISTORS ARE SPECIFIED IN OHMS UNLESS OTHERWISE SPECIFIED.
  2. ALL CAPACITORS ARE SPECIFIED IN P.F. UNLESS OTHERWISE SPECIFIED. ALL CAPACITORS ARE SPECIFIED IN P.F. UNLESS OTHERWISE SPECIFIED.
  3. THE SWITCH IS IN THE '0' POSITION.

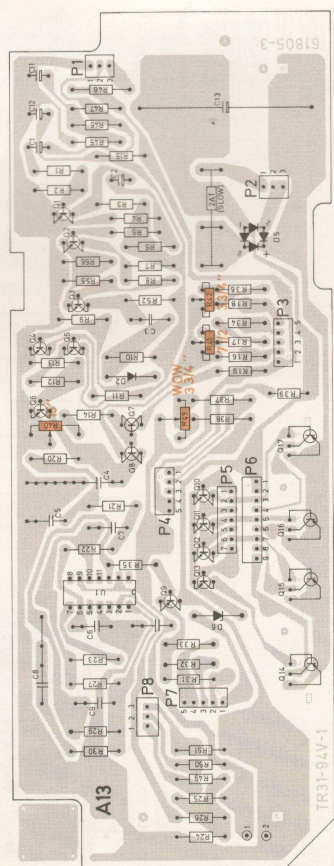

**A13 MOTOR CONTROL**

Modifications introduced on the motor control board from Serial No. 2371350:

| Component | Value     | Changed to:        |
|-----------|-----------|--------------------|
| R39       | 220 ohm   | 150 ohm, 2W        |
| R37/R38   | 150 ohm   | 330 ohm            |
| R32       | 1.8 k ohm | 1.2 k ohm          |
| R33       | 3.3 k ohm | 2.2 k ohm          |
| D6        | IN5242    | Replace with strap |

Table 1 A12.

Modifications introduced on the A7 EQUAL REC. AMP. from approx. No. 2371550

| Component | Value       | Changed to:   |
|-----------|-------------|---------------|
| C4/C104   | 0.1 $\mu$ F | 0.047 $\mu$ F |
| R8/R108   | 680 ohm     | 1.5 k ohm     |

Table 2. All decks: A7

Modifications introduced on the A11 EQUAL PLAYB. AMP. from approx. No. 2371550

| Component   | Value     | Changed to: |
|-------------|-----------|-------------|
| C8/C108*    | 470 pF    | 330 pF      |
| R16/R116*** | 8.2 k ohm | 6.8 k ohm   |
| R1/R101***  | 47 k ohm  | 33 k ohm    |
| R2/R102***  | 47 k ohm  | 33 k ohm    |
| R16/R116*** | 8.2 k ohm | 4.7 k ohm   |

\*\*\* Install on the main board a capacitor, 0.068  $\mu$ F between pin 2 and 5 on contact XA3 and XA4.

\* All decks  
 \*\*\* NAB four track only  
 \*\*\* NAB two track only

Table 3. A11

Modifications introduced on the motor control board from Serial No. 2371350:

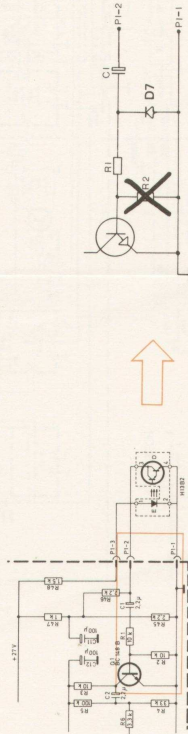

Install D7, 1N4148 between R1 and C1 to ground. R2 removes.

USA only

On USA models, resistors R8-103 and R8-108 mounted on the main board A1 have been changed to 1.2 k ohm. This is because the sensitivity of the mic. input has been changed.

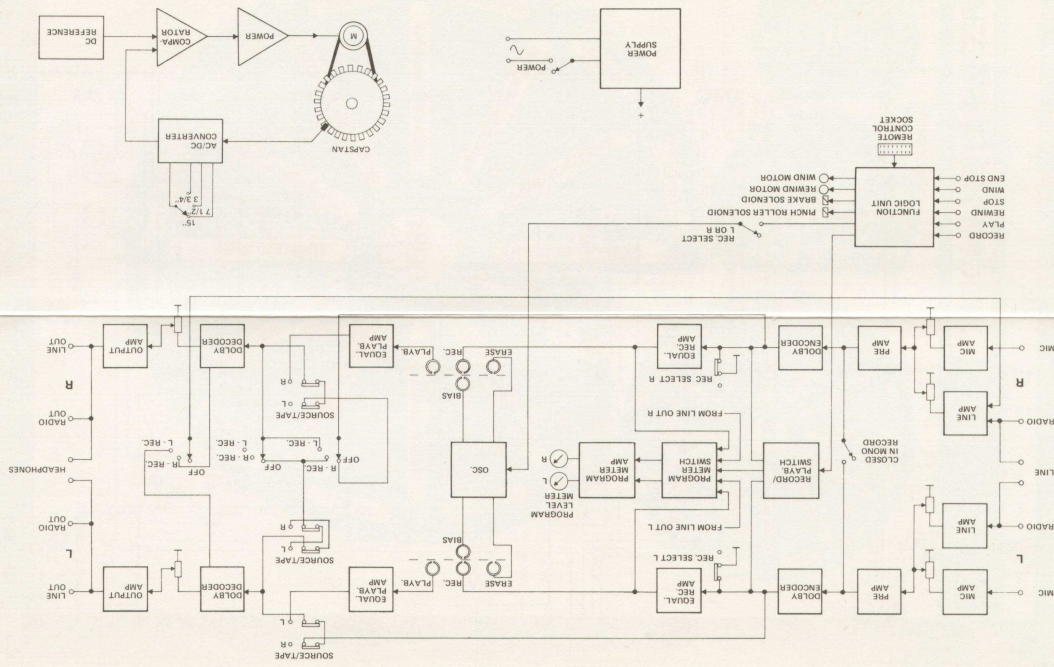



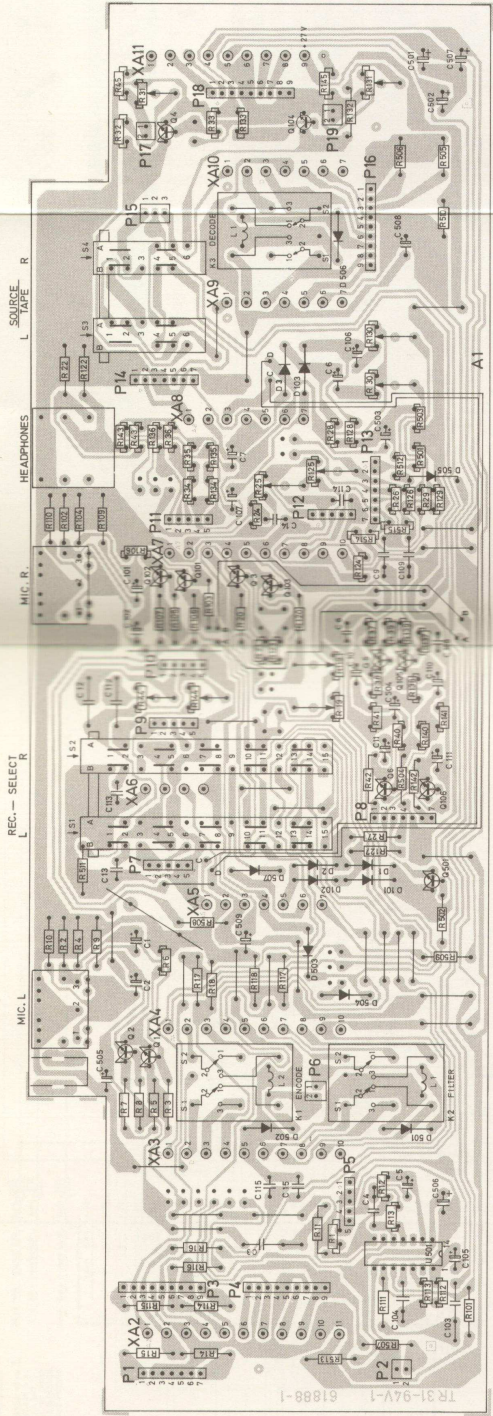

A1 MAIN BOARD FROM SERIAL NO. APPROX. 2372450

**NOTES**

1. UNLESS OTHERWISE SPECIFIED, RESISTANCE IN OHMS
2. UNLESS OTHERWISE SPECIFIED, ALL DIODES IN THIS CIRCUIT ARE 1N4148
3. WHEN REFERRING TO A COMPONENT PART, THE BOARD ASSEMBLY REFERENCE IS COMBINATION (E.G., SPECIFY A311 AND NOT ONLY R1)

**A12 FUNCTION CONTROL LOGIC**

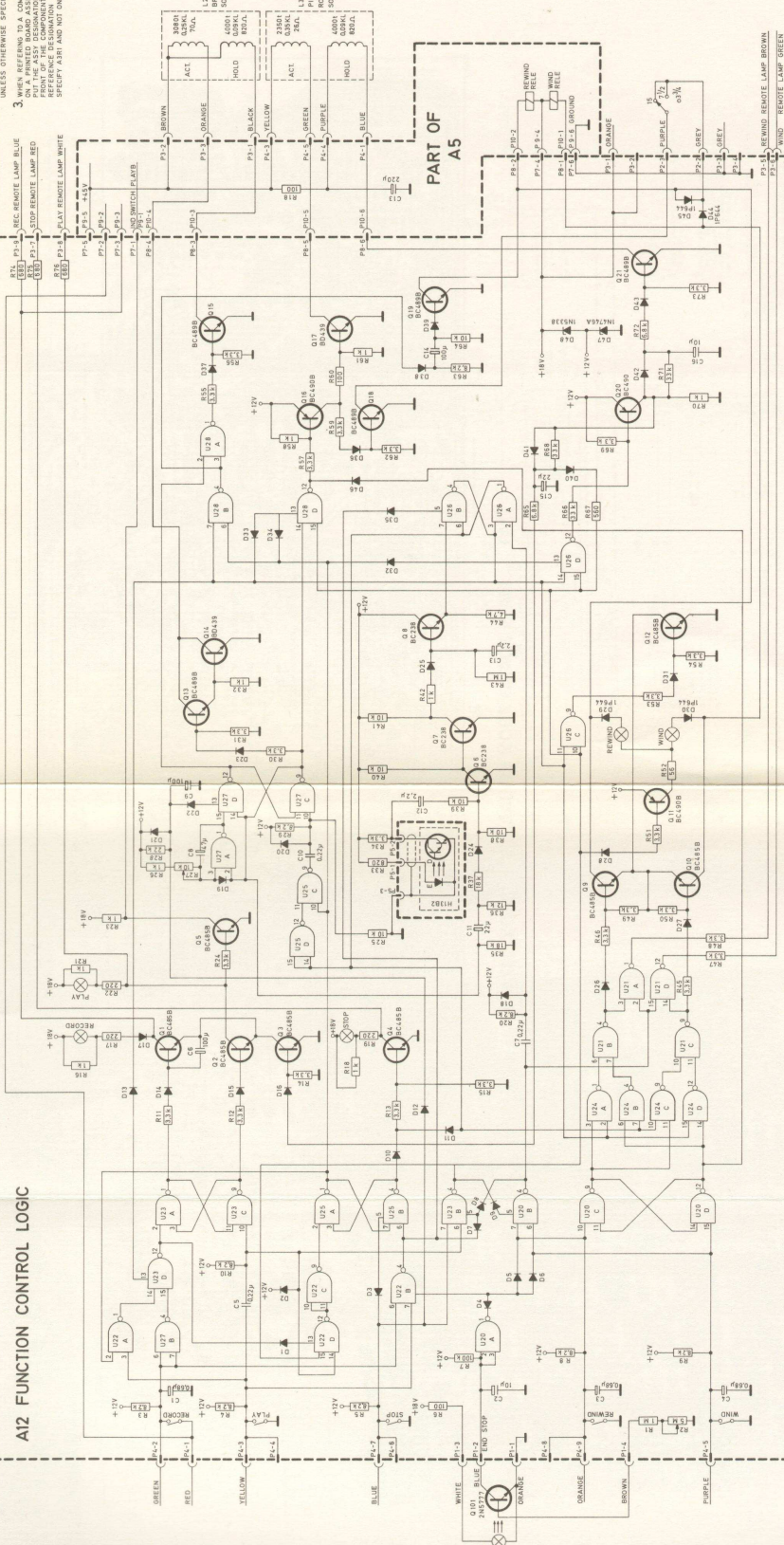

**PART OF A5**

**NOTES**

1. UNLESS OTHERWISE SPECIFIED, RESISTANCE IN OHMS
2. ALL DIODES IN THIS CIRCUIT ARE 1N4148
3. WHEN REFERRING TO A COMPONENT PART, THE BOARD ASSEMBLY REFERENCE IS COMBINATION (E.G., SPECIFY A311 AND NOT ONLY R1)

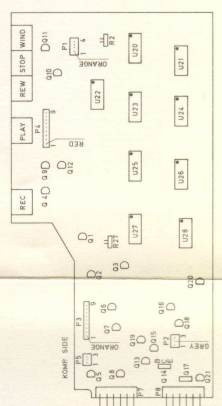

**A12 FUNCTION CONTROL LOGIC CIRCUIT, FROM SERIAL NO. APPROX. 2372800**



**NOTES**

1. UNLESS OTHERWISE SPECIFIED RESISTANCE IN OHMS
2. ALL VALUES IN OHMS UNLESS OTHERWISE SPECIFIED
3. WHEN REFERRING TO A COMPONENT ON A PRINTED BOARD ASSEMBLY, PUT THE ASSY DESIGNATION IN FRONT OF THE COMPONENT IDENTIFICATION. (E.G. SPECIFY A11 AND NOT ONLY R1)

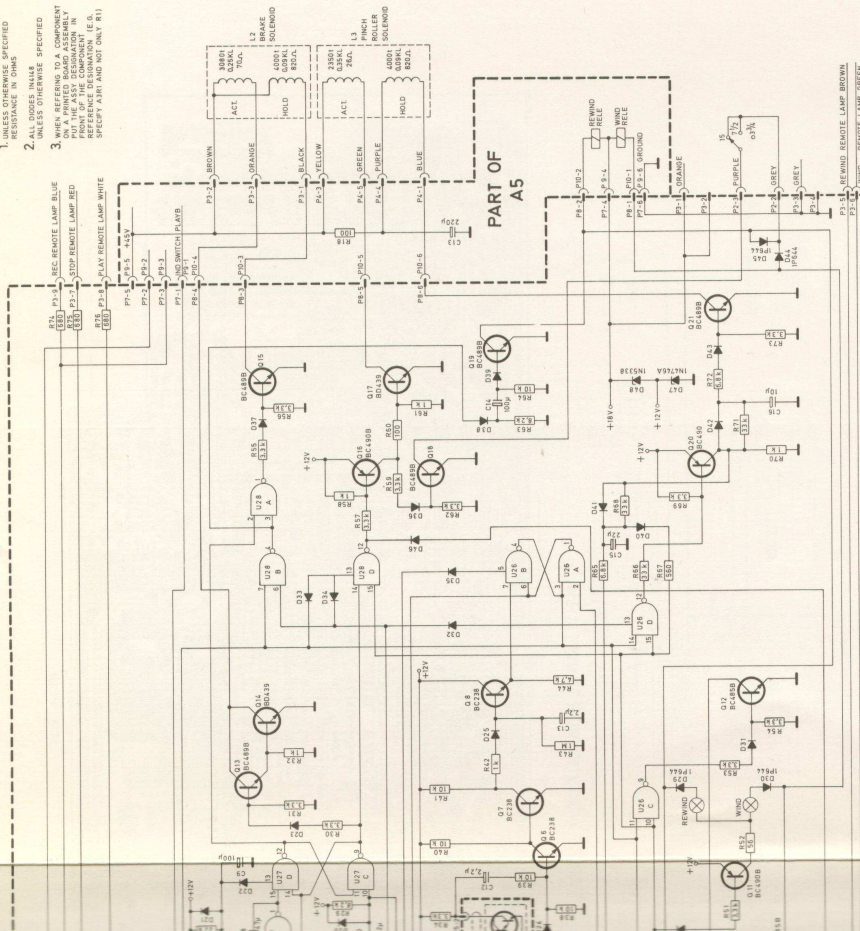

**NOTES**

1. UNLESS OTHERWISE SPECIFIED RESISTANCE IN OHMS
2. ALL VALUES IN OHMS UNLESS OTHERWISE SPECIFIED
3. WHEN REFERRING TO A COMPONENT ON A PRINTED BOARD ASSEMBLY, PUT THE ASSY DESIGNATION IN FRONT OF THE COMPONENT IDENTIFICATION. (E.G. SPECIFY A11 AND NOT ONLY R1)

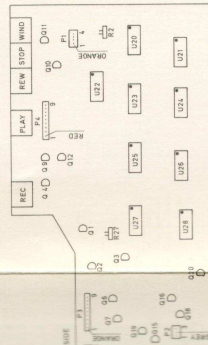

A11 LOGIC CIRCUIT. FROM SERIAL NO. APPROX. 2372800

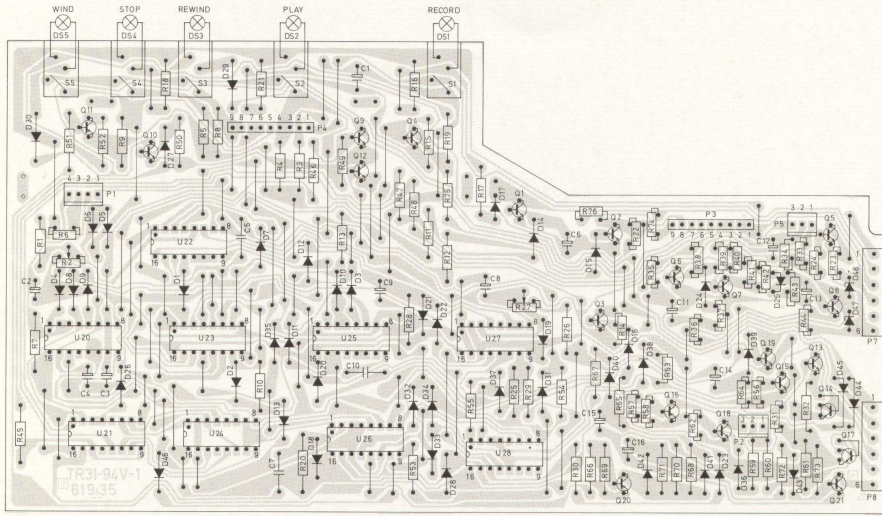

A12 LOGIC BOARD. FROM SERIAL NO. APPROX. 2372800